



# ADMINISTRATIVE AND OPERATIONAL MANUAL





Administrative and Operational Manual

September 12, 2022

Contents

0-000 AOM INTRODUCTION ..... 50
0-001 MANUAL OVERVIEW..... 50
0-001.1 NATURE OF THE MANUAL ..... 50
0-001.2 TERM OF THE MANUAL ..... 50
0-001.3 ORDER OF PRECEDENCE AND SAVING CLAUSE..... 50
0-001.4 KNOWLEDGE REQUIRED ..... 50
0-002 PROCEDURES FOR DISSEMINATION, AUDITING, AND STORAGE OF AGENCY WRITTEN DIRECTIVES ..... 51
0-002.1 GRAMMATICAL CONSTRUCTION..... 52
0-002.2 SOURCE REFERENCES..... 52
0-003 ORGANIZATION OF THE MANUAL..... 52
0-004 REVISIONS AND NEW MATERIAL..... 53
0-004.1 RESEARCH ..... 53
0-004.2 DRAFTS..... 53
0-004.3 REVIEW OF DRAFTS ..... 54
0-005 COMMAND REVIEW..... 54
0-006 OFFICE OF GENERAL COUNSEL APPROVAL..... 54
0-007 SHERIFF'S APPROVAL..... 55
0-008 DISTRIBUTION ..... 55
0-008.1 SHERIFF'S PREROGATIVE..... 55
0-009 STANDARD OPERATING PROCEDURES MANUALS ..... 55
CHAPTER 1 – MISSION, GOALS, AND STANDARDS..... 57
1-001 INTRODUCTION..... 57
1-001.1 MISSION STATEMENT..... 57
1-001.1.1 VALUE STATEMENTS..... 57
1-001.2 GOALS OF THE AGENCY ..... 57
1-002 COMBINED STAFFING ASSESSMENT, STRATEGIC MANAGEMENT PROGRAM (SMP), AND FISCAL YEAR BUDGET PROCESS..... 58
1-002.1 STAFFING ASSESSMENT, ALLOCATION, AND DISTRIBUTION ..... 59
1-002.2 NON-PATROL COMPONENT STAFFING ASSESSMENT PROCESS ..... 59
1-002.3 SWORN PATROL OPERATIONS STAFFING ASSESSMENT AND ASSIGNMENTS..... 60
1-002.4 STRATEGIC MANAGEMENT PROGRAM (SMP) AND BUDGET PROCESS ..... 61
1-002.5 CHRONOLOGICAL OVERVIEW OF THE SMP AND BUDGET PROCESS..... 64
1-003 AGENCY SUCCESSION PLAN..... 65
1-003.1 OVERSIGHT OF THE AGENCY SUCCESSION PLAN..... 65
1-003.2 ESSENTIAL POSITIONS ..... 65
1-003.3 PLANNING FOR AGENCY ATTRITION..... 65
1-003.4 DEVELOPMENT AND MENTORSHIP OF EMPLOYEES ..... 66
1-100 STANDARDS..... 66
1-100.1 OATH OF OFFICE..... 66
1-100.2 AGENCY IDENTIFICATION ..... 67
1-101 ETHICS ..... 67



Administrative and Operational Manual

September 12, 2022

---

1-102	USE OF DISCRETION BY SWORN OFFICERS .....	67
1-103	UNBECOMING CONDUCT .....	68
1-103.1	UNPROFESSIONAL LANGUAGE.....	68
1-104	USE OF FORCE.....	68
1-105	DE-ESCALATION.....	68
1-106	INTEGRITY .....	68
1-107	RELATIONS WITH VENDORS AND CONTRACTORS .....	69
1-108	ENDORSEMENTS .....	69
1-109	PRIVATE COMPENSATION OR REWARD .....	69
1-109.1	DONATIONS TO THE AGENCY.....	69
1-109.2	DONATIONS OF PERISHABLE ITEMS .....	69
1-109.3	DISCOUNTS ON GOODS AND SERVICES.....	70
1-109.4	JURY DUTY.....	70
1-109.5	WITNESS FEES.....	70
1-109.6	USE OF LABOR FOR PUBLIC PURPOSE .....	71
1-110	COURTESY .....	71
1-111	COMPLIANCE WITH LAWFUL ORDERS.....	71
1-113	ATTENTION TO DUTY.....	72
1-114	FINANCIAL OBLIGATIONS .....	72
1-115	IMMORAL CONDUCT .....	72
1-116	ASSOCIATIONS.....	73
1-117	FUNCTIONAL COMMUNICATION / COOPERATION.....	73
1-118	AID TO FELLOW EMPLOYEES .....	73
1-119	REPORTING FOR WORK .....	73
1-120	INSPECTIONS.....	73
1-121	TRAINING .....	74
1-122	EMPLOYEE HEALTH AND FITNESS.....	74
1-122.1	EMPLOYEE ON-DUTY EXERCISE TIME .....	75
1-123	TRUTHFULNESS .....	75
1-124	LOITERING, SLEEPING, MALINGERING ON DUTY .....	75
1-125	FEIGNING SICKNESS OR DISABILITY .....	75
1-126	MEMBERSHIPS IN ORGANIZATIONS .....	76
1-127	POLITICAL ACTIVITY.....	76
1-128	PERSONAL PREFERMENT.....	76
1-129	ADDRESSING RANKING OFFICERS.....	76
1-130	RECOMMENDING LAWYERS AND/OR BONDSMEN TO PRISONERS OR OTHERS.....	76
1-131	FALSE INFORMATION IN RECORDS .....	76
1-132	DUTY TO REPORT INFORMATION .....	76
1-133	CONFIDENTIAL INFORMATION.....	76
1-134	HARASSMENT AND DISCRIMINATION .....	77
1-134.1	BIAS BASED PROFILING.....	77
1-134.2	POLICING IMPARTIALITY .....	77
1-134.3	PREVENTING PERCEPTIONS OF BIASED POLICING.....	77
1-135	DUTY TO GIVE A STATEMENT .....	78
1-136	PERFORMANCE OF DUTY.....	78
1-137	DUTY TO RENDER MEDICAL AID .....	78
1-138	NOTIFICATION TO THE STATE’S ATTORNEY’S OFFICE .....	79
1-139	VIOLATION OF FEDERAL, STATE AND LOCAL LAWS / ORDINANCES .....	79
1-141	PROMOTIONAL EXAMINATION PROCESS SECURITY.....	79
1-142	TAMPERING WITH POSTED MATERIAL.....	79
1-143	SMOKING .....	79



Administrative and Operational Manual

September 12, 2022

1-200	COMMUNITY RELATIONS .....	80
1-200.1	INDIVIDUAL DIGNITY .....	80
1-200.2	THE ROLE OF EMPLOYEES .....	80
1-201	INTERPERSONAL COMMUNICATIONS .....	80
1-202	EQUITY OF TREATMENT .....	80
1-203	OPENNESS OF OPERATIONS .....	81
1-204	COMMUNITY PARTICIPATION BY EMPLOYEES .....	81
1-300	MEDIA RELATIONS.....	81
1-300.1	RELEASE OF INFORMATION.....	81
1-300.1.1	INCIDENTS INVOLVING FATALITIES OR SERIOUS BODILY INJURY .....	82
1-300.2	MEDIA ACCESS TO SCENES .....	82
1-300.3	POLICE REQUEST TO WITHHOLD INFORMATION .....	82
1-300.4	INDIVIDUAL PRESS STATEMENTS .....	83
1-300.5	PRESS RELEASES .....	83
1-300.6	PRESS RELEASE PROCEDURE .....	84
1-300.7	REQUESTS BY CITIZENS FOR RESTRICTED RELEASE OF INFORMATION.....	84
1-305	PRIVATE CITIZENS PHOTOGRAPHING OR VIDEOTAPING POLICE OFFICERS IN PUBLIC.....	84
1-305.1	SUPERVISOR RESPONSIBILITY.....	85
1-305.2	SEIZING A BYSTANDER'S VIDEO RECORDING DEVICE FOR EVIDENTIARY PURPOSES .....	86
1-400	PUBLIC INFORMATION .....	86
1-400.1	FEATURE ARTICLES OR PROGRAM OPERATIONS.....	86
1-400.2	EMPLOYEES' RESPONSIBILITY TO RESPOND TO REQUESTS .....	86
1-500	LABOR RELATIONS.....	86
<b>CHAPTER 2 – AGENCY STRUCTURE, ORGANIZATION, AND RESPONSIBILITIES.....</b>		<b>87</b>
2-100	AGENCY ORGANIZATION .....	87
2-101	AGENCY DEFINITIONS.....	87
2-102	ACRONYMS.....	89
2-102.1	ACRONYMS LIST .....	89
2-103	RANK PRECEDENCE OF SWORN AND CORRECTIONAL PERSONNEL.....	90
2-104	PERSONNEL DEFINITIONS.....	91
2-105	ORGANIZATIONAL TERMS OF REFERENCE.....	92
2-106	24-HOUR STAFFING.....	93
2-107	GENERAL DUTIES AND RESPONSIBILITIES OF COMMAND AND MANAGEMENT.....	93
2-200	AGENCY ORGANIZATIONAL STRUCTURE .....	94
2-200.1	ORGANIZATIONAL CHART – ENTIRE AGENCY .....	96
2-200.2	ORGANIZATIONAL CHART – OFFICE OF THE SHERIFF.....	97
2-200.3	ORGANIZATIONAL CHART – PATROL OPERATIONS .....	98
2-200.4	ORGANIZATIONAL CHART – SPECIAL OPERATIONS DIVISION.....	99
2-200.5	ORGANIZATIONAL CHART – CRIMINAL INVESTIGATIONS DIVISION .....	100
2-200.6	ORGANIZATIONAL CHART – CORRECTIONS DIVISION .....	101
2-200.7	ORGANIZATIONAL CHART – SPECIAL SERVICES DIVISION.....	102
2-200.8	ORGANIZATIONAL CHART – SUPPORT SERVICES DIVISION .....	103
2-200.9	ORGANIZATIONAL CHART – EXECUTIVE SERVICES DIVISION .....	104
2-200.10	ORGANIZATIONAL CHART – TRAINING DIVISION .....	105
2-200.11	ORGANIZATIONAL CHART – ADMINISTRATIVE SERVICES DIVISION.....	106
2-200.12	ORGANIZATIONAL CHART – INFORMATION TECHNOLOGY DIVISION .....	107
2-200.13	ORGANIZATIONAL CHART – OFFICE OF PROFESSIONAL RESPONSIBILITY .....	108
2-250	OFFICE OF THE SHERIFF .....	109
2-250.1	DUTIES AND RESPONSIBILITIES OF THE SHERIFF .....	109
2-251	CHIEF OF STAFF .....	110



Administrative and Operational Manual

September 12, 2022

---

2-252	ASSISTANT SHERIFFS .....	110
2-252.1	EXECUTIVE ADMINISTRATIVE COORDINATOR.....	110
<b>2-260</b>	<b>OFFICE OF PROFESSIONAL RESPONSIBILITY .....</b>	<b>111</b>
2-261	INTERNAL AFFAIRS SECTION.....	111
2-262	RECEIVING COMPLAINTS.....	111
2-262.1	DOCUMENTATION OF COMPLAINTS.....	112
2-262.2	AVAILABILITY OF OPR PERSONNEL.....	113
2-265	STANDARDS, INSPECTIONS, AND SAFETY OFFICER.....	113
2-270	OFFICE OF THE GENERAL COUNSEL.....	113
2-280	EXECUTIVE SERVICES DIVISION.....	114
2-281	EXECUTIVE SERVICES COMMANDER.....	114
2-282	PLANNING & ACCREDITATION.....	114
2-283	MANUAL MAINTENANCE / POLICY DEVELOPMENT FUNCTION.....	115
2-284	ACCREDITATION COORDINATOR.....	115
2-286	GRANT COORDINATOR.....	115
2-287	CHAPLAIN SERVICES.....	115
2-288	MEDIA RELATIONS OFFICE.....	116
2-289	MEDIA RELATIONS SPECIALIST .....	116
2-290	PUBLIC RELATIONS SPECIALIST.....	116
2-291	SPECIAL PROJECTS COORDINATOR.....	117
2-300	PATROL OPERATIONS.....	117
2-300.1	ORGANIZATION OF PATROL OPERATIONS.....	117
2-301	PATROL DIVISION COMMANDERS.....	117
2-302.1	ADMINISTRATIVE SERGEANTS.....	118
2-302.2	ADMINISTRATIVE ASSOCIATE - PATROL .....	118
2-303	SHIFT COMMANDERS.....	118
2-303.1	HOURS OF WORK .....	118
2-303.2	GENERAL RESPONSIBILITIES .....	118
2-303.3	COORDINATION WITH OTHER AGENCY COMPONENTS .....	119
2-303.4	BUDGET AND RESOURCE MANAGEMENT .....	119
2-304.2	SHIFT COMMANDERS' RESPONSIBILITIES.....	119
2-304.3	REPORTING AND NOTIFICATION RESPONSIBILITIES.....	119
2-305	SECTOR SUPERVISORS.....	120
2-306	PATROL DIVISION OFFICERS.....	120
2-307	TELEPHONE REPORTING FUNCTION.....	120
<b>2-350</b>	<b>SPECIAL OPERATIONS DIVISION (SOD).....</b>	<b>121</b>
2-350.1	ORGANIZATION OF THE SPECIAL OPERATIONS DIVISION.....	121
<b>2-351</b>	<b>COMMANDER, SPECIAL OPERATIONS DIVISION.....</b>	<b>121</b>
<b>2-352</b>	<b>SPECIAL OPERATIONS DIVISION SECRETARY.....</b>	<b>121</b>
<b>2-360</b>	<b>COMMANDER, COMMUNITY SERVICES SECTION .....</b>	<b>121</b>
<b>2-361</b>	<b>COMMUNITY POLICING (COPS) UNIT.....</b>	<b>121</b>
<b>2-362</b>	<b>CRIME PREVENTION UNIT.....</b>	<b>122</b>
2-362.1	ALCOHOL ENFORCEMENT FUNCTION .....	122
2-362.2	ELECTRONIC FINGERPRINTING FUNCTION.....	123
<b>2-363</b>	<b>COMMUNITY ORGANIZER FUNCTION.....</b>	<b>123</b>



Administrative and Operational Manual

September 12, 2022

---

2-363.1	CITIZENS ADVISORY COMMITTEE.....	123
<b>2-364</b>	<b>CRISIS NEGOTIATIONS TEAM (CNT) FUNCTION .....</b>	<b>124</b>
<b>2-365</b>	<b>SPECIAL EVENT RESPONSE TEAM (SERT) FUNCTION .....</b>	<b>125</b>
<b>2-366</b>	<b>AUXILIARY FUNCTION .....</b>	<b>125</b>
<b>2-367</b>	<b>HONOR GUARD FUNCTION.....</b>	<b>125</b>
<b>2-370</b>	<b>SCHOOL RESOURCES SECTION COMMANDER.....</b>	<b>126</b>
<b>2-371</b>	<b>SCHOOL RESOURCES UNITS.....</b>	<b>126</b>
2-371.1	CRIMINAL JUSTICE PROGRAM FUNCTION.....	126
2-371.1.1	EXPLORER POST #1658 PROGRAM.....	126
2-371.2	SCHOOL CROSSING GUARDS FUNCTION .....	127
<b>2-372</b>	<b>TEEN COURT FUNCTION.....</b>	<b>127</b>
<b>2-373</b>	<b>SEARCH MANAGEMENT FUNCTION .....</b>	<b>127</b>
<b>2-380</b>	<b>COMMANDER, FIELD OPERATIONS SECTION.....</b>	<b>127</b>
<b>2-381</b>	<b>TRAFFIC OPERATIONS UNIT.....</b>	<b>127</b>
2-381.1	AUTOMATED ENFORCEMENT FUNCTION .....	128
2-381.2	INTOXIMETER OPERATOR FUNCTION .....	128
<b>2-382</b>	<b>EMERGENCY SERVICES TEAM (EST) FUNCTION.....</b>	<b>129</b>
<b>2-383</b>	<b>K-9 FUNCTION .....</b>	<b>129</b>
<b>2-384</b>	<b>SECURITY RESPONSE VESSEL (SRV) FUNCTION .....</b>	<b>129</b>
<b>2-385</b>	<b>UNMANNED AERIAL SYSTEMS (UAS) FUNCTION.....</b>	<b>129</b>
<b>2-386</b>	<b>DRUG RECOGNITION EXPERT (DRE) FUNCTION.....</b>	<b>130</b>
<b>2-387</b>	<b>MOTORCYCLE FUNCTION.....</b>	<b>130</b>
2-400	CRIMINAL INVESTIGATIONS DIVISION (CID).....	130
2-401	CRIMES INVESTIGATED BY CID.....	131
2-402	COMMANDER, CRIMINAL INVESTIGATIONS DIVISION .....	131
2-403	UNIT SUPERVISOR'S RESPONSIBILITIES .....	132
2-404	DETECTIVES' RESPONSIBILITIES.....	132
2-405	COMMANDER, PERSONS CRIMES SECTION.....	133
2-405.1	MAJOR CRIMES UNIT.....	133
2-405.2	SPECIAL VICTIMS UNIT .....	134
2-405.2.1	COMFORT CANINE FUNCTION .....	134
2-405.3	ROBBERY UNIT.....	134
2-405.4	DIGITAL FORENSICS UNIT.....	134
2-406	PROPERTY CRIMES SECTION.....	135
2-406.1	PROPERTY CRIMES UNIT .....	135
2-406.2	FINANCIAL CRIMES UNIT .....	135
2-406.3	VICTIM / WITNESS SERVICES FUNCTION .....	136
2-407	COMMANDER, NARCOTICS ENFORCEMENT SECTION.....	136
2-407.1	STREET NARCOTICS ENFORCEMENT UNIT.....	137
2-407.2	MAJOR NARCOTICS UNIT .....	137
2-407.3	HIGH INTENSITY DRUG TRAFFICKING AREA - HIDTA.....	137
2-407.4	ADMINISTRATIVE DRUG ANALYST.....	137



Administrative and Operational Manual

September 12, 2022

---

2-408 HOMELAND SECURITY AND INTELLIGENCE SECTION..... 137

2-408.1 EMERGENCY MANAGEMENT AND HOMELAND SECURITY..... 138

2-408.3 FIREARMS INVESTIGATION UNIT (FIU)..... 140

2-408.4 CRIME ANALYSIS FUNCTION..... 140

2-409 THREATS OF MASS VIOLENCE OR THREATS TO HARM OFFICIALS (OTHER THAN LAW ENFORCEMENT OFFICERS) OR ATTACK GOVERNMENT FACILITIES ..... 141

2-410 OFFICER SAFETY ALERTS..... 141

2-410.1 DISSEMINATION ..... 141

2-411 DISSEMINATION OF PHOTOGRAPHS AND CREATION OF CRIME BULLETINS..... 141

2-412 FORENSIC SCIENCE SECTION ..... 141

2-450 CORRECTIONS DIVISION..... 142

2-450.1 ORGANIZATION..... 142

2-451 COMMANDER / DIRECTOR, CORRECTIONS DIVISION..... 142

2-451.1 INTERNAL INVESTIGATOR ..... 143

2-452 DEPUTY DIRECTOR..... 143

2-453 STANDARDS AND ACCREDITATION COMMANDER..... 143

2-454 ADMINISTRATIVE SUPERVISOR ..... 144

2-460 CUSTODY AND SECURITY SECTION ..... 144

2-461 ASSISTANT COMMANDER, CUSTODY AND SECURITY..... 145

2-462 SHIFT COMMANDER..... 145

2-463 SHIFT SUPERVISOR ..... 145

2-463.1 ASSISTANT SHIFT SUPERVISOR..... 145

2-470 SUPPORT SERVICES SECTION..... 145

2-471 CENTRAL PROCESSING UNIT..... 146

2-472 INTAKE..... 146

2-473 TRANSPORT ..... 147

2-474 CENTRAL PROCESSING ..... 147

2-475 INMATE PROGRAMS AND SERVICES UNIT ..... 147

2-476 CLASSIFICATION ..... 147

2-476.1 INTELLIGENCE OFFICER ..... 147

2-476.2 SECURITY MAINTENANCE SERGEANT..... 147

2-480 CCDC ANNEX..... 148

2-481 ASSISTANT COMMANDER, ANNEX ..... 148

2-482 WORK RELEASE..... 148

2-482.1 WORK RELEASE ASSISTANT ..... 149

2-482.2 WORK RELEASE INVESTIGATOR..... 149

2-482.3 INMATE ACCOUNTING SPECIALIST..... 149

2-500 SPECIAL SERVICES DIVISION ..... 149

2-500.1 ORGANIZATION OF SPECIAL SERVICES DIVISION..... 149

2-501 SPECIAL SERVICES DIVISION COMMANDER..... 150

2-502 JUDICIAL SERVICES SECTION..... 150

2-502.1 ORGANIZATION..... 151

2-510 COMMANDER, JUDICIAL SERVICES SECTION ..... 151

2-515 DOMESTIC VIOLENCE UNIT..... 151

2-515.1 SUPERVISOR'S RESPONSIBILITIES..... 151

2-515.2 DUTIES OF OFFICERS ASSIGNED TO DOMESTIC VIOLENCE ..... 151

2-515.3 DOMESTIC VIOLENCE SPECIALIST..... 152

2-520 WARRANT / FUGITIVE UNIT..... 152

2-520.1 SUPERVISOR'S RESPONSIBILITIES..... 152

2-520.2 DUTIES OF OFFICERS ASSIGNED TO WARRANT SERVICE ..... 152



Administrative and Operational Manual

September 12, 2022

---

2-520.3	WARRANT / FUGITIVE SPECIALIST .....	152
2-530	CIVIL UNIT.....	152
2-530.1	CIVIL UNIT SUPERVISOR .....	153
2-530.2	CIVILIAN CIVIL PROCESS SERVER SPECIALISTS .....	153
2-530.3	DUTIES OF CIVILIAN CIVIL PROCESS SERVER SPECIALISTS.....	153
2-530.4	DUTIES OF OFFICERS ASSIGNED TO SERVE CIVIL PROCESS .....	154
2-530.5	CIVIL SPECIALISTS.....	154
2-535	COURTS / JUDICIAL SECURITY UNIT.....	154
2-535.1	COURTS / JUDICIAL SECURITY UNIT SUPERVISORS.....	154
2-536	VOLUNTEERS IN COMMUNITY SERVICE (VICS) .....	155
2-536.1	COURT SECURITY OFFICER.....	155
2-536.1.1	COURT SECURITY OFFICER FIELD TRAINING PROGRAM.....	155
2-536.1.2	COURT SECURITY FTO PROGRAM RESPONSIBILITY.....	156
2-536.1.3	COURT SECURITY FTO PROGRAM DESCRIPTION.....	156
2-536.2	COURTHOUSE SECURITY AIDE .....	156
2-536.3	DUTIES OF COURTHOUSE SECURITY AIDE .....	156
2-540	CHILD SUPPORT ENFORCEMENT UNIT .....	156
2-540.1	CHILD SUPPORT ENFORCEMENT UNIT SUPERVISOR.....	157
2-540.2	CHILD SUPPORT ENFORCEMENT UNIT COORDINATOR.....	157
2-540.3	CHILD SUPPORT ENFORCEMENT UNIT WARRANT SPECIALIST .....	157
2-540.4	CHILD SUPPORT ENFORCEMENT UNIT CIVIL PROCESS SERVER SPECIALIST.....	157
2-540.5	CHILD SUPPORT COURT OFFICER .....	157
2-550	COMMANDER, PROPERTY MANAGEMENT .....	158
2-551	PROPERTY HELD OFFICER .....	159
2-551.1	PROPERTY HELD CUSTODIAN .....	159
2-552	FIREARMS TRACKING SPECIALIST .....	160
2-553	QUARTERMASTER .....	160
2-553.1	QUARTERMASTER INVENTORY SPECIALIST .....	161
2-554	PROCUREMENT SPECIALIST.....	161
2-555	FLEET MANAGER .....	161
2-555.1	FLEET SERVICES TECHNICIAN SPECIALIST .....	162
2-555.2	FLEET INVENTORY SPECIALIST .....	162
2-555.3	FLEET SERVICES TECHNICIAN.....	162
2-556	AGENCY FACILITIES MANAGER.....	162
2-600	SUPPORT SERVICES DIVISION .....	162
2-600.1	ORGANIZATION OF THE DIVISION .....	163
2-601	SUPPORT SERVICES DIVISION COMMANDER .....	163
2-610	COMMUNICATIONS SECTION.....	163
2-611	COMMUNICATIONS SECRETARY .....	163
2-613	POLICE COMMUNICATIONS OFFICER (PCO) SUPERVISOR .....	163
2-613.1	POLICE COMMUNICATIONS OFFICER (PCO) .....	164
2-614	POLICE STATION SUPERVISOR.....	164
2-614.1	POLICE STATION TECHNICIANS .....	164
2-620	RECORDS MANAGEMENT SECTION.....	165
2-621	RECORDS MANAGEMENT SUPERVISOR.....	165
2-622	POLICE RECORDS TECHNICIANS.....	165
2-623	OFFICE ASSOCIATE.....	166
2-700	INFORMATION TECHNOLOGY DIVISION (ITD) .....	166
2-731	DIRECTOR, ITD.....	166
2-732	SYSTEMS OPERATIONS MANAGER .....	166
2-733	SYSTEMS OPERATIONS UNIT .....	166





Administrative and Operational Manual

September 12, 2022

2-733.1 NETWORK SPECIALIST ..... 167

2-733.2 DATABASE ADMINISTRATOR..... 167

2-734 APPLICATIONS MANAGER ..... 167

2-735 APPLICATIONS SECTION ..... 167

2-735.1 SYSTEMS ANALYST ..... 167

2-737 TECHNICAL SUPPORT MANAGER..... 168

2-738 TECHNICAL SUPPORT SECTION..... 168

2-739 TECHNICAL SUPPORT SPECIALIST ..... 168

2-740.1 IT ADMINISTRATIVE SUPPORT SPECIALIST ..... 168

**2-800 TRAINING DIVISION ..... 168**

2-800.1 ORGANIZATION OF TRAINING DIVISION..... 168

2-801 TRAINING DIVISION COMMANDER ..... 168

2-805 SOUTHERN MARYLAND CRIMINAL JUSTICE ACADEMY..... 170

2-805.1 TRAINING COORDINATOR ..... 170

2-805.2 TRAINING INSTRUCTOR..... 170

2-810 TRAINING SECTION..... 170

2-810.1 SPECIFIC RESPONSIBILITIES ..... 170

**2-811 TRAINING PROGRAMS ..... 171**

2-812 TRAINING ADVISORY COUNCIL..... 172

2-813 TRAINING SPECIALIST ..... 172

2-814 FIREARMS INSTRUCTION DETAIL..... 172

2-815 CADET PROGRAM ..... 173

2-900 ADMINISTRATIVE SERVICES DIVISION ..... 173

2-901 ACCOUNTING SECTION ..... 173

2-902 PAYROLL..... 174

2-903 CASH FUNDS..... 174

2-904 INMATE ACCOUNTING ..... 174

2-905 GRANT ACCOUNTING ..... 174

2-910 BUDGETING SECTION ..... 175

2-911 ACCOUNTING SYSTEM..... 175

2-920 HUMAN RESOURCES SECTION..... 176

2-921 PERSONNEL FUNCTIONS ..... 176

2-922 PRE-EMPLOYMENT/ RECRUITMENT..... 177

2-923 RECRUITING PROCESS ..... 179

2-924 ANALYSIS..... 179

**CHAPTER 3 – AGENCY ADMINISTRATION, UNIFORMS, AND APPEARANCE ..... 179**

**3-100 AGENCY PERSONNEL SUBJECT TO SUMMONS OR SUBPOENA..... 179**

**3-100.1 DEFINITIONS ..... 179**

**3-100.2 SUBPOENAS ..... 180**

**3-100.3 STATE’S ATTORNEY’S OFFICE – COURT NOTIFICATION PROGRAM (“ESUBPOENA”) ..... 180**

**3-100.4 DISTRICT COURT – PAYABLE TRAFFIC DOCKETS ..... 181**

**3-100.5 UNAVAILABILITY FOR COURT; SAO AND DISTRICT COURT NOTIFICATIONS ..... 181**

**3-100.6 SUBPOENAS FOR NON-RECORDS MANAGEMENT EMPLOYEES ..... 181**

**3-100.7 SUBPOENAS – RECORDS MANAGEMENT ..... 182**

**3-100.8 SUBPOENAS – DETENTION CENTER ..... 182**

**3-101 ATTENDING COURT..... 183**

3-104 EMPLOYEES AS LITIGANTS - PROHIBITIONS..... 183

3-105 OFFICERS AS WITNESSES ..... 183



Administrative and Operational Manual

September 12, 2022

---

3-106	AGENCY MAIL HANDLING.....	184
3-106.1	MAIL REQUIRING SIGNATURES .....	184
3-106.2	CADET MAIL DELIVERY .....	184
3-106.3	MAIL NEEDING US POSTAGE .....	184
3-107	RIDE-ALONG PROGRAM.....	184
3-107.1	GENERAL .....	185
3-107.1.1	SPECIFIC GUIDELINES.....	186
3-107.2	RIDE-ALONG PROCEDURES .....	186
3-107.3	RESPONSIBILITIES OF THE OFFICER .....	186
3-107.4	EXPLORER’S POST #1658 RIDE-ALONGS.....	187
3-107.4.1	OFFICER GUIDELINES.....	187
3-107.4.2	HIGH RISK CALL/SITUATIONS.....	187
3-108	REVIEW/ RELEASE OF A PERSONNEL FILE .....	188
3-108.1	REVIEW BY SUPERVISORY AUTHORITY.....	188
3-108.2	PERSONNEL RECORDS WHICH ARE SUBJECT TO REVIEW .....	189
<b>3-109</b>	<b>NOTIFICATION OF EMPLOYEE’S VITAL INFORMATION CHANGE.....</b>	<b>189</b>
3-110	RELEASE OF TELEPHONE OR ADDRESS INFORMATION.....	189
3-111	SOLICITATION OF MEMBERS/ EMPLOYEES WHILE WORKING .....	189
3-113	FLAG PROTOCOL AND GESTURES OF RESPECT – GENERALLY .....	189
3-113.1	FLAGS.....	190
3-113.1.1	POW / MIA FLAG.....	192
3-113.2	GESTURES OF RESPECT .....	192
3-114	EMPLOYMENT TERMINATION.....	193
3-114.1	EMPLOYEE RESIGNATION.....	193
3-114.2	RETIREMENT PROCEDURES.....	193
3-114.3	NOTICE OF INVOLUNTARY TERMINATION OF EMPLOYMENT .....	194
3-114.4	EMPLOYMENT CLEARANCE FORM .....	194
3-114.4.1	FAILURE TO COMPLETE FORM AND/ OR RETURN AGENCY PROPERTY .....	195
3-114.5	FINANCIAL AGREEMENT.....	196
3-114.6	CLERK OF THE COURT NOTIFICATION.....	196
3-114.7	EXIT INTERVIEWS.....	196
3-116	EMPLOYEE ASSISTANCE PROGRAM (EAP) .....	196
<b>3-117</b>	<b>DEATH AND FUNERAL PROCEDURES.....</b>	<b>197</b>
<b>3-117.1</b>	<b>INTRODUCTION TO FUNERAL PROCEDURES.....</b>	<b>197</b>
<b>3-117.2</b>	<b>NOTIFICATION OF DEATH OF A MEMBER OF THE CCSO FAMILY.....</b>	<b>197</b>
<b>3-117.2.1</b>	<b>MEMBERS OF THE CRISIS RESPONSE TEAM (CRT).....</b>	<b>198</b>
<b>3-117.2.2</b>	<b>PURPOSE OF THE NOTIFICATION TEAM.....</b>	<b>198</b>
<b>3-117.3</b>	<b>TASKS FOR CRT TO ACCOMPLISH.....</b>	<b>199</b>
<b>3-117.4</b>	<b>PLANNING COMMITTEE MAKEUP.....</b>	<b>200</b>
<b>3-117.5</b>	<b>HONORS GUIDELINES FOR EACH TYPE OF AGENCY FUNERAL.....</b>	<b>204</b>
<b>3-117.6</b>	<b>PLANNING COMMITTEE TASKS.....</b>	<b>206</b>
<b>3-117.7</b>	<b>MEMORIAL CAR.....</b>	<b>208</b>
<b>3-117.8</b>	<b>DEATH BUNTING FOR CCSO FACILITY BUILDINGS .....</b>	<b>208</b>
<b>3-117.9</b>	<b>MOURNING BANDS.....</b>	<b>208</b>
<b>3-120</b>	<b>FUNERALS FOR MEMBERS OF OTHER LAW ENFORCEMENT AGENCIES.....</b>	<b>208</b>
<b>3-121</b>	<b>REQUEST TO SERVE AS A PALLBEARER IN UNIFORM FOR SOMEONE OUTSIDE THE AGENCY .....</b>	<b>208</b>
<b>3-122</b>	<b>PROCEDURAL VARIATION.....</b>	<b>209</b>
<b>3-123</b>	<b>AGENCY SENTIMENTS OF SYMPATHY .....</b>	<b>209</b>
<b>3-123.1</b>	<b>SOURCE OF FUNDING .....</b>	<b>209</b>
<b>3-123.2</b>	<b>LEVELS OF EXPENDITURES AND DELIVERIES.....</b>	<b>209</b>
<b>3-123.3</b>	<b>APPLICABILITY.....</b>	<b>210</b>



Administrative and Operational Manual

September 12, 2022

- 3-123.4 RECORD KEEPING..... 210**
- 3-123.5 INTERAGENCY ANNOUNCEMENT OF DEATHS - AGENCY PERSONNEL FAMILY MEMBERS, PROMINENT CITIZENS, AND PUBLIC OFFICIALS ..... 210**
- 3-130 CRIMINAL JUSTICE AND SOCIAL SERVICE DIVERSION PROGRAMS ..... 211
- 3-149 REQUESTS FOR LAW ENFORCEMENT ASSISTANCE ..... 211
- 3-150 MARYLAND STATE POLICE - COOPERATIVE AGREEMENT ..... 212
- 3-150.1 RESPONSIBILITIES OF THE CHARLES COUNTY SHERIFF’S OFFICE ..... 212
- 3-150.2 RESPONSIBILITIES OF THE MARYLAND STATE POLICE ..... 213
- 3-150.3 CONCURRENT INVESTIGATIVE RESPONSIBILITIES ..... 213
- 3-150.4 MUTUAL ASSISTANCE..... 214
- 3-150.5 WARRANT SERVICE ..... 214
- 3-150.6 COOPERATIVE EFFORTS..... 214
- 3-150.7 RESOLUTION OF OPERATIONAL QUESTIONS REGARDING MOU ..... 214
- 3-151 MEMORANDUM OF UNDERSTANDING (MOU) - COLONIAL BEACH POLICE DEPARTMENT ..... 214
- 3-151.1 COLONIAL BEACH POLICE ACTIVITIES..... 215
- 3-151.2 CCSO COMMUNICATIONS RESPONSIBILITIES..... 215
- 3-151.3 COMMANDER / SUPERVISOR’S RESPONSIBILITIES ..... 215
- 3-151.4 RESPONSIBILITIES OF SENIOR OFFICER / SUPERVISOR ON THE SCENE ..... 215
- 3-151.5 RESPONSIBILITIES OF OFFICERS..... 216
- 3-151.6 RECORDS SECTION RESPONSIBILITIES ..... 217
- 3-151.7 RESPONSIBILITIES OF COLONIAL BEACH POLICE..... 217
- 3-152 MEMORANDUM OF UNDERSTANDING (MOU) - KING GEORGE COUNTY, VA. SHERIFF’S OFFICE..... 217
- 3-152.1 KING GEORGE COUNTY SHERIFF’S ACTIVITIES..... 217
- 3-152.2 CCSO COMMUNICATIONS RESPONSIBILITIES..... 218
- 3-152.3 COMMANDER / SUPERVISOR’S RESPONSIBILITIES ..... 218
- 3-152.4 RESPONSIBILITIES OF SENIOR OFFICER / SUPERVISOR ON THE SCENE ..... 218
- 3-152.5 RESPONSIBILITIES OF OFFICERS..... 219
- 3-152.6 RECORDS SECTION RESPONSIBILITIES ..... 219
- 3-152.7 RESPONSIBILITIES OF KING GEORGE COUNTY, VA. SHERIFF’S OFFICERS ..... 220
- 3-155 MOU - CHARLES COUNTY BOARD OF EDUCATION..... 221
- 3-155.1 PERSONS WHO MAY DENY ACCESS TO SCHOOL GROUNDS..... 221
- 3-155.2 DENYING ACCESS..... 221
- 3-155.3 PENALTIES ..... 221
- 3-155.4 CAUTIONS..... 221
- 3-156 MEMORANDUM OF UNDERSTANDING WITH THE LA PLATA POLICE DEPARTMENT ..... 222
- 3-156.1 CALLS FOR SERVICE IN THE TOWN OF LA PLATA, MARYLAND ..... 222
- 3-156.2 MUTUAL ASSISTANCE AND TIMELY RESPONSE ..... 224
- 3-160 MEMORANDUM OF UNDERSTANDING - CHARLES COUNTY DEPARTMENT OF EMERGENCY SERVICES..... 225
- 3-160.1 BACKGROUND AND PURPOSE..... 226
- 3-160.2 ROLES AND RESPONSIBILITIES..... 226
- 3-160.3 OPERATIONAL GUIDELINES..... 227
- 3-160.4 GENERAL TERMS ..... 228
- [REDACTED]
- [REDACTED]
- [REDACTED]
- [REDACTED]
- [REDACTED]
- [REDACTED]
- [REDACTED]
- [REDACTED]
- [REDACTED]
- 3-162 MUTUAL AID AGREEMENTS - CALVERT COUNTY SHERIFF’S OFFICE AND ST. MARY’S COUNTY SHERIFF’S OFFICE ..... 233



Administrative and Operational Manual

September 12, 2022

3-162.1 DEFINITIONS..... 233

3-162.2 GENERAL REQUIREMENTS ..... 233

3-162.3 RESPONSIBILITIES - COMMUNICATIONS ..... 234

3-162.4 RESPONSIBILITIES - COMMAND / SUPERVISION..... 234

3-162.5 RESPONSIBILITIES - RESPONDING OFFICERS ..... 235

3-163 MEMORANDUM OF AGREEMENT FOR JOINT INVESTIGATIVE PROCEDURES OF CHILD PHYSICAL AND SEXUAL ABUSE 236

3-163.1 DEFINITIONS..... 236

3-163.2 NOTIFICATIONS ..... 237

3-163.3 INVESTIGATIVE PROCEDURES ..... 237

3-163.4 SPECIAL INVESTIGATIVE PROCEDURES - THE CHARLES COUNTY PUBLIC SCHOOLS..... 238

3-163.5 SPECIAL INVESTIGATION PROCEDURES - CHILD CARE HOMES / CENTERS ..... 238

3-163.6 DISPOSITION ..... 240

3-164 MEMORANDUM OF UNDERSTANDING - MARYLAND TRANSPORTATION AUTHORITY POLICE ..... 241

3-164.1 GENERAL REQUIREMENTS ..... 241

3-164.2 CALLS FOR SERVICE ON MARYLAND TRANSPORTATION AUTHORITY PROPERTIES ..... 241

3-164.3 CONCURRENT LAW ENFORCEMENT JURISDICTION ..... 241

3-164.4 POINT OF CONTACT..... 242

3-164.5 LIABILITY..... 242

3-165 MEMORANDUM OF AGREEMENT - JOINT INVESTIGATIVE PROCEDURES OF VULNERABLE ADULTS..... 243

3-165.1 DEFINITIONS..... 243

3-165.2 RESPONSIBILITIES - CHARLES COUNTY SHERIFF’S OFFICE..... 244

3-165.3 RESPONSIBILITIES - CHARLES COUNTY DEPARTMENT OF SOCIAL SERVICES..... 244

3-166 MEMORANDUM OF UNDERSTANDING (MOU) WITH THE MARYLAND DEPARTMENT OF NATURAL RESOURCES 246

3-167 INTERAGENCY AGREEMENT BETWEEN THE MARYLAND DIVISION OF PAROLE AND PROBATION AND THE SHERIFF OF CHARLES COUNTY ..... 247

3-167.1 RESPONSIBILITIES - DIVISION OF PAROLE AND PROBATION..... 247

3-167.2 RESPONSIBILITIES - CHARLES COUNTY SHERIFF’S OFFICE..... 247

3-168 AGREEMENT BETWEEN THE UNITED STATES DEPARTMENT OF THE INTERIOR AND THE STATE OF MARYLAND .. 248

3-169 MUTUAL AID AGREEMENT – PRINCE GEORGE’S COUNTY POLICE DEPARTMENT..... 249

3-169.1 CONDITIONS FOR INTERDEPARTMENTAL TRANSFER OF PERSONNEL..... 249

3-169.2 RESPONSIBILITIES - RESPONDING OFFICERS ..... 250

**3-170 BLUE RIBBON PROJECT – BACKPACKS OF LOVE ..... 250**

3-170.1 NOTIFICATION..... 250

3-170.2 DELIVERY..... 250

3-170.3 STORAGE OF BACKPACKS..... 251

3-170.4 NOTIFICATION OF DELIVERY..... 251

3-176 SPECIAL ACCESS TO PRIVATE PROPERTY AND PUBLIC BUILDINGS..... 252

**3-200 RECORDS SECTION ..... 253**

3-200.1 GENERAL RESPONSIBILITIES ..... 253

3-201 PURPOSE OF REPORTS..... 253

3-202 RECORDS CONTROL..... 253

3-202.1 RECORDS COLLECTION ..... 253

3-203 RECORDS REVIEW..... 253

3-204 FEE SCHEDULES ..... 253

3-208 RECORD RETENTION..... 254

3-208.1 RECORDS MAINTENANCE AND DISPOSAL ..... 254

3-209 CONFIDENTIALITY RULES..... 254

3-210 REPORT/PHOTOGRAPH REQUEST FORMS..... 254



Administrative and Operational Manual

September 12, 2022

---

3-211	CRIMINAL RECORDS INQUIRIES.....	255
3-212	TELEPHONE REQUESTS FOR CRIMINAL HISTORY RECORDS INFORMATION.....	255
3-213	IDENTITY VERIFICATION.....	255
3-214	DISCLOSABLE CRIMINAL HISTORY RECORDS INFORMATION.....	255
3-215	POLICE REPORTS - AUTHORIZED PERSONS / AGENCIES.....	255
3-216	APPEAL PROCEDURES.....	256
3-217	JUVENILE RECORDS.....	256
3-217.1	DISCLOSABLE RECORDS.....	256
3-217.2	DISCLOSURE PROCEDURES.....	256
3-217.3	RECORDS REVIEW BY RESPONDENTS.....	256
3-217.4	JUVENILE DISPOSITION INFORMATION REQUESTS.....	256
3-217.5	AUTHORIZED JHRI RECIPIENTS.....	257
3-217.6	SANCTIONS FOR UNAUTHORIZED DISCLOSURES.....	257
3-218	EXPUNGEMENT OF RECORDS.....	257
3-218.1	EXPUNGEMENT PROCEDURES.....	257
3-218.2	EXPUNGEMENT ACCESS GUIDELINES.....	258
3-218.3	EXPUNGEMENT COMPLIANCE REQUIRED.....	258
3-218.4	SANCTIONS FOR UNAUTHORIZED DISCLOSURES.....	258
3-220	TRAFFIC RECORDS.....	258
3-221	PHOTOGRAPHIC DOCUMENTATION / EVIDENCE.....	258
3-221.1	DIGITAL FORMATS.....	259
3-221.2	DIGITAL AND NEGATIVE PRINT FILM IMAGE INTEGRITY.....	259
3-221.3	USE OF DIGITAL CAMERAS FOR PHOTOGRAPHING CRIME SCENES.....	260
3-221.4	FSS RESPONSIBILITIES AND IMAGE INTEGRITY.....	260
3-221.5	CRASH PHOTOGRAPHS.....	261
3-221.6	NON-EVIDENTIARY PHOTOGRAPHS.....	261
3-221.6.1	IDENTIFICATION PHOTOGRAPHS.....	261
3-221.6.2	DIGITAL ARREST PHOTOGRAPHS.....	261
<b>3-225</b>	<b>GRANT PROCESS.....</b>	<b>261</b>
3-225.1	DEVELOPMENT OF GRANT APPLICATION.....	262
3-225.2	GRANT AWARD PROCEDURES.....	262
3-225.3	COMPLETION OF GRANTS.....	263
3-230	AGENCY COMPUTER SYSTEMS.....	264
3-230.1	RESPONSIBILITY FOR COMPUTERS AND COMPUTER SYSTEMS.....	264
3-230.2	COORDINATION OF EFFORT.....	264
3-230.3	SYSTEM PURCHASE, INSTALLATION, MAINTENANCE, ETC.....	264
3-230.4	AVAILABILITY OF SERVICE.....	265
3-230.5	SPECIFICS OF HANDLING COMPUTER EQUIPMENT AND SOFTWARE.....	265
3-230.6	USE OF PIRATED OR UNLICENSED SOFTWARE.....	265
3-230.7	MAINTENANCE PROCEDURES.....	265
3-230.8	COMPUTER / SOFTWARE ENHANCEMENTS AND CHANGES.....	266
3-231	OPERATOR CERTIFICATION AND LOGIN ID APPLICATION.....	266
3-231.1	UNLOADING THE NETWORK.....	266
3-232	AGENCY ELECTRONIC MAIL (EMAIL), VOICE MAIL AND INTERNET USAGE - GENERALLY.....	266
3-232.1	CONTENT OF EMAIL AND VOICE MAIL.....	267
3-232.2	INTERNET USAGE.....	267
3-232.3	PROCEDURES FOR USAGE OF COMPUTER EQUIPMENT AND ELECTRONIC COMMUNICATIONS SYSTEMS.....	267
3-232.4	INTRANET BULLETIN BOARD.....	269
<b>3-234</b>	<b>SOCIAL NETWORKING - AGENCY ACCOUNTS.....</b>	<b>269</b>



Administrative and Operational Manual

September 12, 2022

---

3-234.1	MANAGEMENT OF NETWORKING ACCOUNTS.....	269
3-234.2	AUTHORIZATION OF POSTINGS.....	269
3-234.3	REMOVAL OF POSTINGS AND ASSOCIATIONS.....	270
3-234.4	PERSONAL USE OF SOCIAL NETWORKING SITES.....	270
3-235	MOBILE DATA TERMINALS.....	271
3-235.1	GENERAL POLICY.....	271
3-235.2	MDT USER RESPONSIBILITIES.....	272
3-235.3	GENERAL MDT USAGE.....	272
3-235.4	SOFTWARE / HARDWARE MAINTENANCE.....	273
3-235.5	CARE OF EQUIPMENT.....	274
3-235.6	ELECTRONICALLY TRANSMITTED CORRESPONDENCE.....	274
3-235.7	MOBILE PRINTING.....	275
3-235.8	OPERATING PROCEDURES FOR WIRELESS MOBILE COMPUTING DEVICES.....	275
3-235.9	AUTOMATIC VEHICLE LOCATION (AVL).....	275
3-240	LICENSE PLATE READER PROGRAM.....	277
3-240.1	AUDIT.....	278
<b>3-250</b>	<b>MOBILE FINGERPRINT IDENTIFICATION SYSTEM (FIS).....</b>	<b>279</b>
3-251	PURPOSE.....	279
3-250.1	POLICY.....	279
3-252	CONSENT PRIOR TO SCANNING.....	279
3-253	PROCEDURE.....	279
<b>3-290</b>	<b>AGENCY CASH FUNDS.....</b>	<b>279</b>
3-290.1	AUTHORIZED AGENCY ACCOUNTS.....	280
3-290.1.1	REPORTING RESPONSIBILITIES OF AUTHORIZED AGENCY ACCOUNTS.....	283
3-290.1.2	PROCEDURES FOR REPLENISHING CERTAIN AUTHORIZED AGENCY ACCOUNTS.....	283
<b>3-300</b>	<b>SUPPLIES AND MAINTENANCE.....</b>	<b>284</b>
3-301	DIVISION COMMANDERS'/ DIRECTORS' RESPONSIBILITIES.....	284
3-302	PURCHASING PROCEDURES.....	284
3-303	DOCUMENTATION OF RECEIPT.....	285
3-304	EQUIPMENT REPAIR.....	286
3-305	CAPITAL AND FIXED AGENCY ASSETS.....	286
3-306	INVENTORY AND CONTROL OF AGENCY PROPERTY.....	287
3-307	TRANSFER OF AGENCY PROPERTY AND EQUIPMENT.....	287
3-308	TRANSFERS OF EQUIPMENT ASSIGNED TO PERSONNEL.....	287
3-309	DISPOSAL OF EQUIPMENT, AGENCY PROPERTY, OR ASSETS.....	288
<b>3-500</b>	<b>UNIFORMS AND EQUIPMENT.....</b>	<b>289</b>
3-501	PERSONALLY OWNED EQUIPMENT.....	289
3-501.1	LOSS OR DAMAGE OF PERSONAL PROPERTY AND EQUIPMENT.....	289
3-501.1.1	DEFINITIONS: LOST AND DAMAGED.....	290
3-501.1.2	REPAIR / REPLACEMENT LIMITS.....	290
3-501.1.3	PROCEDURE FOR REIMBURSEMENT.....	290
3-502	DUTY TO CARE FOR AGENCY EQUIPMENT AND PROPERTY.....	290
3-503	LOSS OR DAMAGE TO PROPERTY.....	291
3-503.1	RESPONSIBILITY TO REPORT.....	291
3-503.2	FORM COMPLETION.....	291
3-504	QUARTERMASTER RESPONSIBILITIES.....	291
<b>3-505</b>	<b>REPLACEMENT OF ITEMS WHICH BECOME UNSERVICEABLE THROUGH NORMAL USE.....</b>	<b>292</b>



Administrative and Operational Manual

September 12, 2022

3-505.1 REPLACEMENT OF LOST, STOLEN OR EMPLOYEE DAMAGED ISSUED ITEMS ..... 292

3-505.2 REPLACEMENT OF EXPENDABLE ITEMS..... 292

3-510 WEAR AND DISPLAY OF UNIFORMS..... 293

3-512 EXCHANGE AND REPLACEMENT OF UNIFORM AND EQUIPMENT ITEMS ..... 294

3-513 DISPOSAL OF UNSERVICEABLE UNIFORM ITEMS..... 294

**3-520 ORIGINAL ISSUE – UNIFORMS AND EQUIPMENT..... 295**

3-520.1 ORIGINAL ISSUE - SWORN OFFICERS ..... 295

3-520.1.1 ORIGINAL ISSUE – SWORN OFFICERS – TRUNK KIT ..... 296

3-520.2 ORIGINAL ISSUE - COURT SECURITY OFFICERS ..... 296

3-520.3 ORIGINAL ISSUE - CORRECTIONAL OFFICERS..... 297

3-520.4 ORIGINAL ISSUE - POLICE COMMUNICATIONS OFFICERS..... 297

3-520.5 ORIGINAL ISSUE - CROSSING GUARDS..... 298

3-520.6 ORIGINAL ISSUE - CIVILIAN FORENSIC SCIENCE PERSONNEL ..... 298

3-520.7 ORIGINAL ISSUE – CADETS..... 298

3-520.8 ORIGINAL ISSUE - COURTHOUSE SECURITY AIDES..... 299

3-520.9 ORIGINAL ISSUE - CIVILIAN PERSONNEL..... 299

3-520.10 ORIGINAL ISSUE – CITIZEN’S POLICE ACADEMY ALUMNI..... 300

3-520.11 ORIGINAL ISSUE – CHAPLAIN SERVICES ..... 300

**3-521 SUPPLEMENTAL ISSUE OF UNIFORMS AND EQUIPMENT ..... 300**

3-521.1 SUPPLEMENTAL ISSUE – SWORN FORENSIC SCIENCE SECTION..... 301

3-521.2 SUPPLEMENTAL ISSUE - K-9 OFFICERS..... 301

3-521.3 SUPPLEMENTAL ISSUE - EST TEAM..... 301

3-521.4 SUPPLEMENTAL ISSUE - MOTORCYCLE OFFICERS ..... 302

3-521.5 SUPPLEMENTAL ISSUE - CORRECTIONS ERT TEAM..... 302

3-521.6 SUPPLEMENTAL ISSUE - CORRECTIONS TRANSPORT OFFICERS..... 303

3-521.7 SUPPLEMENTAL ISSUE - TRAINING ACADEMY STAFF ..... 303

3-521.8 SUPPLEMENTAL ISSUE - TRAINING ACADEMY..... 303

3-521.9 SUPPLEMENTAL ISSUE - AGENCY FIREARMS INSTRUCTORS..... 304

3-521.10 SUPPLEMENTAL ISSUE - TRAFFIC OPERATIONS OFFICERS..... 304

3-521.11 SUPPLEMENTAL ISSUE - NARCOTICS DETECTIVES ..... 304

3-521.12 SUPPLEMENTAL ISSUE - SWORN OFFICERS - CRIMINAL INVESTIGATIONS DIVISION AND JUDICIAL SERVICES SECTION 305

3-521.13 SUPPLEMENTAL ISSUE – SECURITY RESPONSE VESSEL FUNCTION OPERATORS..... 305

3-521.14 SUPPLEMENTAL ISSUE – BICYCLE UNIT..... 305

3-521.15 SUPPLEMENTAL ISSUE - HONOR GUARD (EFFECTIVE: 1/26/18)..... 306

3-521.16 SUPPLEMENTAL ISSUE – SPECIAL EVENT RESPONSE TEAM (SERT) ..... 306

**3-530 SPECIFIC UNIFORM RULES ..... 306**

3-531 UNIFORM SHIRTS / NECKTIE / MOCK TURTLENECK DICKIE..... 306

3-532 NON-COMMISSIONED OFFICERS DISPLAY OF RANK..... 307

3-533 RANK DISPLAY PINS..... 307

3-534 BADGES ..... 308

3-534.1 COLLAR BRASS..... 309

3-535 DRESS BLOUSE..... 309

3-536 UNIFORM TROUSERS..... 310

3-538 GORE-TEX PATROL JACKET ..... 310

3-539 WOOL PATROL JACKET ..... 310

3-540 WEARING OF THE PATROL JACKET ..... 310

3-541 WOOL PULLOVER SWEATER (COMMANDO SWEATER) ..... 310



Administrative and Operational Manual

September 12, 2022

---

3-542	REEFER OVERCOAT .....	311
3-543	RAID JACKET .....	311
3-544	SHOULDER PATCHES .....	311
3-545	RAIN GEAR.....	311
3-546	UNDERSHIRTS.....	311
3-547	FOOTWEAR .....	311
3-548	RAIN BOOTS.....	312
3-549	HEADGEAR .....	312
3-550	NECKTIE.....	313
3-551	SOCKS.....	313
3-552	GLOVES.....	313
3-553	MOURNING BANDS AND RIBBONS.....	313
3-553.1	U. S. FLAG RIBBON.....	313
3-553.2	CALEA ACCREDITATION PIN .....	313
<b>3-554</b>	<b>GROOMING STANDARDS.....</b>	<b>315</b>
3-554.1	ALL AGENCY EMPLOYEES.....	315
3-554.1.1	TATTOOS .....	315
3-554.1.2	UNCONVENTIONAL BODY PIERCING .....	315
3-554.1.3	DENTAL ORNAMENTATION .....	315
3-554.2	UNIFORMED SWORN POLICE AND CORRECTIONS MEMBERS .....	315
3-554.2.1	HAIR REGULATIONS.....	315
3-554.2.2	FACIAL HAIR.....	316
3-554.2.3	MAKEUP AND JEWELRY .....	317
3-554.2.4	EYE WEAR.....	318
3-554.3	CIVILIAN MEMBERS GROOMING STANDARDS .....	318
3-555	NAMEPLATE .....	318
3-556	COAT COLLAR BRASS .....	319
3-557	TIE DEVICES .....	319
3-558	SPECIAL INSIGNIA PINS .....	319
3-559	AWARD ACCOUTERMENTS.....	320
3-562	MARKSMANSHIP BADGE .....	320
3-563	SAM BROWNE BELT / POLICE EQUIPMENT BELT .....	320
3-564	GARRISON BELT .....	320
3-565	REQUIRED ARTICLES ON POLICE EQUIPMENT BELTS (SWORN) .....	321
3-566	REQUIRED ARTICLES ON POLICE EQUIPMENT BELTS (CORRECTIONS) .....	321
3-567	OPTIONAL ARTICLES ON POLICE EQUIPMENT BELTS (SWORN) .....	321
3-568	OPTIONAL ARTICLES ON POLICE EQUIPMENT BELTS (CORRECTIONS).....	321
3-569	BELT KEEPERS .....	321
3-570	MAGAZINE HOLDER.....	322
3-571	HANDCUFF CASE .....	322
3-572	BATON AND BATON HOLDER.....	322
3-573	MINIATURE FLASHLIGHT .....	322
3-574	HOLSTERS .....	322
3-575	PORTABLE RADIO CARRIERS .....	322
3-576	ITEMS ARRANGED ON POLICE EQUIPMENT BELT .....	322
3-577	ISSUED BODY ARMOR.....	322
3-577.1	GENERAL GUIDELINES .....	323
3-577.2	EXTERNAL BODY ARMOR CARRIER.....	323
3-577.3	TACTICAL VEST CARRIER.....	324
3-578	ISSUED TRAFFIC SAFETY VEST .....	324





Administrative and Operational Manual

September 12, 2022

3-580 ILLUSTRATION - BASIC WINTER UNIFORM SHIRT AND ACCOUTERMENTS ..... 324

3-581 ILLUSTRATION - COMMISSIONED OFFICERS WOOL PATROL JACKET AND BLOUSE ..... 325

3-583 ILLUSTRATION - DRESS BLOUSE / WOOL PATROL JACKET WITH COLLAR BRASS - LARGE STATE SEAL - COMMAND OFFICERS ..... 325

3-584 ILLUSTRATION - DRESS BLOUSE/WOOL PATROL JACKET WITH COLLAR BRASS -NON-COMMAND OFFICERS ..... 326

3-590 BASIC UNIFORMS DESCRIBED..... 327

3-590.1 DRESS UNIFORM - SWORN NON-COMMISSIONED OFFICERS..... 327

3-590.2 DRESS UNIFORM - SWORN AND CORRECTIONS COMMISSIONED OFFICERS..... 327

3-590.3 BASIC SWORN WINTER UNIFORM..... 328

3-590.4 BASIC SWORN SUMMER UNIFORM..... 329

3-590.5 BASIC CORRECTIONS WINTER UNIFORM ..... 329

3-590.6 BASIC CORRECTIONS SUMMER UNIFORM ..... 329

3-590.7 BASIC CIVILIAN UNIFORM..... 330

**3-591 ALTERNATE UNIFORM DESCRIPTIONS ..... 330**

3-591.1 K-9 BDU ..... 330

3-591.2 CORRECTIONS ERT BDU..... 331

3-591.3 SWORN OFFICER BDU..... 331

3-591.4 SCHOOL RESOURCE OFFICERS ALTERNATE UNIFORM..... 331

3-592 AUTHORIZED UNIFORMS OF THE DAY ..... 332

3-593 ATTIRE FOR PLAIN CLOTHES OFFICERS ..... 332

3-594 COURT ATTIRE ..... 332

**3-595 CIVILIAN MEMBER UNIFORMS / ATTIRE ..... 333**

3-595.1 UNIFORMED CIVILIAN MEMBERS..... 333

3-595.1.1 BASIC CIVILIAN UNIFORM ..... 333

3-595.1.2 TRAINING DIVISION ..... 333

3-595.1.3 FORENSIC SCIENCE SECTION AND DIGITAL FORENSICS UNIT..... 333

3-595.2 NON-UNIFORMED CIVILIAN MEMBERS..... 333

3-595.2.1 PROFESSIONAL BUSINESS ATTIRE ..... 333

3-595.2.2 CASUAL BUSINESS ATTIRE ..... 334

3-596 RECOGNITION OF YEARS OF SERVICE ..... 335

3-596.1 SERVICE MEDALS FOR UNIFORMED EMPLOYEES ..... 335

3-596.2 CIVILIAN ATTIRE SERVICE AWARD ..... 335

3-596.3 PRESENTATION OF AWARDS ..... 335

**3-600 DISCRIMINATION AND HARASSMENT..... 337**

3-600.1 AGENCY POLICY ..... 337

3-600.2 DEFINITIONS..... 337

3-600.3 GENERAL SUPERVISORY RESPONSIBILITIES..... 338

3-600.4 COMPLAINT HANDLING ..... 338

3-600.5 COMPLAINT RESOLUTION ..... 340

3-600.6 REPRISALS ..... 341

3-600.7 DISCIPLINARY ACTION ..... 341

**3-601 DOMESTIC VIOLENCE AND THE WORKPLACE..... 342**

3-601.1 DEFINITIONS..... 342

3-601.2 CONFIDENTIALITY ..... 342

3-601.3 WORK ENVIRONMENT ..... 342

3-601.4 DISCIPLINARY PROCEDURES FOR EMPLOYEES WHO COMMIT ACTS OF DOMESTIC VIOLENCE ..... 343

3-601.5 EMPLOYEE RESPONSIBILITIES..... 343



Administrative and Operational Manual

September 12, 2022

3-601.6 VICTIM RESPONSIBILITIES AND ASSISTANCE OPTIONS..... 343

3-601.7 PERPETRATOR RESPONSIBILITIES..... 343

3-601.8 SUPERVISOR RESPONSIBILITIES..... 343

3-601.9 AGENCY EMPLOYEE ASSISTANCE PROGRAM COORDINATOR RESPONSIBILITIES..... 344

3-601.10 SAFETY..... 344

3-602 CHARLES COUNTY SHERIFF’S OFFICE CLASSIFICATION POLICY..... 345

3-602.1 DEFINITIONS..... 345

**3-602.2 POLICY..... 345**

**3-602.3 ADMINISTRATION..... 345**

**3-602.4 PROCEDURES..... 346**

3-602.5 ENTRY LEVEL SWORN AND CORRECTIONAL POSITIONS..... 347

**3-602.6 PROBATIONARY PERIODS..... 347**

**3-602.7 OBTAINING PERMANENT STATUS..... 349**

**3-602.8 DUTY STATUS..... 349**

**3-602.9 DESCRIPTION OF SWORN/CORRECTIONAL OFFICER CLASSES..... 349**

**3-602.10 APPOINTED POSITIONS..... 352**

**3-602.11 LATERAL POSITIONS WITHIN THE CHARLES COUNTY SHERIFF’S OFFICE..... 353**

**3-602.12 SPECIALIZED ASSIGNMENTS..... 354**

**3-603 COLLECTIVE BARGAINING..... 355**

3-603.1 NEGOTIATIONS..... 355

3-603.2 AGREEMENT AND RATIFICATION..... 356

3-603.3 DISSEMINATION AND IMPLEMENTATION..... 356

**3-605 COMPENSATION..... 356**

3-605.1 DEFINITIONS..... 357

3-605.2 PAY SCALES..... 357

3-605.3 PAYCHECKS..... 357

3-605.4 DUTY HOURS..... 358

3-605.4.1 COMPRESSED WORK SCHEDULE PROGRAM..... 358

3-605.5 NOTIFICATION OF CHANGE IN SCHEDULE..... 360

3-605.6 PATROL OPERATIONS – MINIMUM HOURS OFF BETWEEN SHIFTS..... 361

3-605.7 MEAL PERIODS..... 361

3-605.8 ANNIVERSARY MERIT/ STEP PAY INCREASES..... 361

**3-606 SPECIAL PAY CATEGORIES..... 362**

3-606.1 K-9 OFFICER COMPENSATION..... 362

3-606.1.1 K-9 ADOPTION VETERINARY EXPENSE REIMBURSEMENT..... 362

3-606.2 FIELD TRAINING OFFICER (FTO) COMPENSATION..... 362

3-606.3 SHIFT DIFFERENTIAL..... 363

3-606.4 ACTING PAY..... 364

3-606.5 AVAILABILITY OF ACTING PAY FOR A PARTICULAR POSITION..... 364

3-606.6 FOREIGN LANGUAGE PROFICIENCY PAY..... 365

3-606.7 TITLE COMPENSATION..... 365

**3-607 OVERTIME COMPENSATION..... 365**

**3-607.1 COURT TIME..... 366**

**3-607.2 ON-CALL / CALL BACK COMPENSATION..... 367**

**3-607.3 OVERTIME APPROVAL..... 368**

**3-608 LEAVE..... 368**



Administrative and Operational Manual

September 12, 2022

---

3-608.1	DEFINITIONS.....	368
3-608.2	ANNUAL LEAVE.....	369
3-608.3	OFFICERS ON APPROVED EXTENDED LEAVE.....	370
<b>3-609</b>	<b>SICK AND SAFE LEAVE .....</b>	<b>370</b>
3-609.1	DEFINITIONS.....	370
3-609.2	SICK AND SAFE LEAVE ACCRUAL RATES AND USAGE .....	371
3-609.3	NEW EMPLOYEE SICK AND SAFE LEAVE ADVANCE .....	371
3-609.4	SICK AND SAFE LEAVE QUALIFYING EVENTS .....	372
3-609.5	SICK AND SAFE LEAVE NOTIFICATION AND APPROVAL.....	372
3-609.6	SICK AND SAFE LEAVE ABUSE .....	372
3-609.7	MANDATED SICK AND SAFE LEAVE USE.....	373
3-609.8	EXTENDED SICK AND SAFE LEAVE.....	373
3-609.9	EXTENDED SICK AND SAFE LEAVE – EMPLOYEE’S RESPONSIBILITIES .....	373
3-609.10	EXTENDED SICK AND SAFE LEAVE – SUPERVISOR’S RESPONSIBILITIES .....	374
3-609.11	EXTENDED SICK AND SAFE LEAVE – HUMAN RESOURCES RESPONSIBILITIES .....	374
3-609.12	DIVISION COMMANDER RESPONSIBILITIES.....	374
3-609.13	SECONDARY EMPLOYMENT WHILE ON SICK AND SAFE LEAVE / EXTENDED SICK AND SAFE LEAVE OR DISABILITY LEAVE	374
3-609.14	PRESCRIPTION MEDICATIONS.....	374
3-609.15	NON-PRESCRIPTION MEDICATIONS .....	375
3-609.16	FELLOW EMPLOYEE’S RESPONSIBILITIES .....	375
3-609.17	ADVANCED SICK AND SAFE LEAVE.....	375
<b>3-610</b>	<b>INJURED IN THE LINE OF DUTY (ILD) LEAVE - SWORN AND CORRECTIONAL OFFICERS .....</b>	<b>376</b>
<b>3-610.1</b>	<b>ON DUTY INJURY / ILLNESS—DISABILITY / WORKERS’ COMPENSATION .....</b>	<b>376</b>
<b>3-610.2</b>	<b>DENIAL OF ADMINISTRATIVE LEAVE FOR LINE-OF-DUTY INJURY CLAIM .....</b>	<b>377</b>
<b>3-610.3</b>	<b>ADMINISTRATIVE LEAVE GRANTED FOR LINE-OF-DUTY INJURY CLAIM .....</b>	<b>377</b>
3-610.3.1	DISABILITY/MEDICAL RETIREMENT .....	377
<b>3-610.4</b>	<b>BENEFITS AVAILABLE TO INJURED WORKERS - CIVILIAN EMPLOYEES.....</b>	<b>378</b>
<b>3-610.5</b>	<b>EXAMINATION BY SHERIFF’S OFFICE CONTRACT PHYSICIAN .....</b>	<b>378</b>
<b>3-610.6</b>	<b>EMPLOYEE JOB-INDUCED PSYCHOLOGICAL DISORDERS .....</b>	<b>379</b>
3-611	MODIFIED DUTY.....	379
3-611.1	MODIFIED DUTY ASSIGNMENTS.....	379
3-611.2	MODIFIED DUTY RESTRICTIONS FOR SWORN POLICE AND CORRECTIONAL OFFICERS .....	380
3-611.3	SECONDARY EMPLOYMENT WHILE ON MODIFIED DUTY .....	381
3-611.4	DUTY STATUS – SWORN POLICE AND CORRECTIONAL OFFICERS .....	381
3-612	FAMILY AND MEDICAL LEAVE ACT.....	384
3-612.1	DEFINITIONS FOR FMLA PURPOSES.....	384
3-612.2	ELIGIBILITY .....	385
3-612.3	TYPES OF LEAVE UNDER FMLA .....	385
3-612.4	MILITARY FAMILY LEAVE ENTITLEMENTS.....	386
3-612.5	FMLA PROCEDURES.....	386
3-612.6	MEDICAL CERTIFICATION .....	387
3-612.7	USE OF PAID AND UNPAID LEAVE.....	387
3-612.8	UNPAID LEAVE.....	387
3-612.9	REPORTING WHILE ON LEAVE .....	388
3-612.10	FMLA COORDINATION WITH WORKERS’ COMPENSATION .....	388
3-612.11	EMPLOYEE STATUS AND BENEFITS DURING LEAVE .....	388
3-612.12	SPOUSES EMPLOYED BY THE CHARLES COUNTY SHERIFF’S OFFICE.....	388
3-612.13	RETURNING TO WORK.....	388
3-612.14	CONFIDENTIALITY OF MEDICAL RECORDS.....	389



Administrative and Operational Manual

September 12, 2022

---

3-613	COMPENSATORY LEAVE .....	389
3-613.1	ANNUAL COMPENSATORY LEAVE BANK – SWORN .....	389
3-613.2	USE OF COMPENSATORY LEAVE – SWORN.....	389
3-613.3	ANNUAL COMPENSATORY LEAVE BANK – CORRECTIONS .....	390
3-613.4	ANNUAL COMPENSATORY LEAVE BANK – PCO’s / POLICE STATION TECHNICIANS .....	390
3-613.5	ANNUAL COMPENSATORY LEAVE BANK – ALL OTHER CRITICAL AND OPERATIONAL CIVILIANS .....	390
3-613.6	COMMUNICATIONS SECTION – WORK SCHEDULE / REQUIRED LEAVE USE.....	391
<b>3-614</b>	<b>HOLIDAY LEAVE .....</b>	<b>391</b>
<b>3-614.1</b>	<b>HOLIDAY LEAVE ACCOUNT .....</b>	<b>392</b>
3-615	PERSONAL LEAVE.....	393
3-615.1	OLD PERSONAL LEAVE - SWORN POLICE OFFICERS .....	394
3-616	ADMINISTRATIVE LEAVE.....	394
3-616.1	CLOSINGS, DELAYED OPENINGS, OR EARLY DISMISSAL SITUATIONS.....	394
3-616.1.1	OPERATIONAL STATUS CODES AND EMPLOYEE NOTIFICATIONS FOR INCLEMENT WEATHER OR OTHER UNUSUAL SITUATIONS .....	394
3-616.1.2	EMPLOYEE COMPENSATION FOR CLOSURES, DELAYED OPENINGS AND EARLY DISMISSALS.....	396
3-616.2	ADMINISTRATIVE LEAVE PENDING AN INTERNAL INVESTIGATION .....	396
<b>3-617</b>	<b>MILITARY LEAVE .....</b>	<b>397</b>
3-617.1	ADVANCE NOTIFICATION OF DUTY .....	397
3-617.2	SCHEDULED MONTHLY DRILLS .....	398
3-617.3	FIVE-YEAR CUMULATIVE SERVICE .....	399
3-617.4	HONORABLE RELEASE .....	399
3-617.5	TIMELY RETURN TO AGENCY DUTIES.....	399
3-617.6	RETURN FROM MILITARY DUTY.....	399
3-617.7	MILITARY LEAVE WITH PAY .....	400
3-617.8	MILITARY LEAVE WITHOUT PAY .....	400
3-617.9	USE OF LEAVE OTHER THAN MILITARY LEAVE .....	401
3-617.10	GAP PAY.....	401
<b>3-618</b>	<b>EMPLOYEE LEAVE DONATION PROGRAM.....</b>	<b>401</b>
<b>3-618.1</b>	<b>ADMINISTRATION - LEAVE DONATION PROGRAM.....</b>	<b>401</b>
<b>3-618.2</b>	<b>LEAVE DONATIONS .....</b>	<b>402</b>
<b>3-618.3</b>	<b>PROCEDURES - REQUESTING EMPLOYEE .....</b>	<b>402</b>
<b>3-618.4</b>	<b>PROCEDURES - DONATING EMPLOYEE .....</b>	<b>402</b>
<b>3-618.5</b>	<b>ADMINISTRATIVE PROCEDURES .....</b>	<b>403</b>
3-619	LEAVE WITHOUT PAY.....	403
3-619.1	PROCEDURES – EMPLOYEE.....	403
3-619.2	PROCEDURES - SUPERVISORS / COMMANDERS / DIRECTORS.....	404
3-620	TUITION REIMBURSEMENT PROGRAM .....	405
3-620.1	EMPLOYEE DEVELOPMENT .....	405
3-620.2	ELIGIBILITY .....	405
3-620.3	COURSE CRITERIA.....	405
3-620.4	FINANCIAL REIMBURSEMENT AND COSTS COVERED .....	405
3-620.5	REQUIRED GRADES.....	406
3-620.6	SERVICE COMMITMENT .....	406
3-620.7	APPLICANT RESPONSIBILITIES .....	406
3-620.8	SUPERVISORY RESPONSIBILITIES.....	406
3-620.9	COMMAND RESPONSIBILITIES .....	406
3-620.10	HUMAN RESOURCES RESPONSIBILITIES (APPROVAL PROCESS) .....	406
3-620.11	REPORTING RESPONSIBILITIES .....	407



Administrative and Operational Manual

September 12, 2022

---

3-620.12	HUMAN RESOURCES RESPONSIBILITIES (PAYMENT PROCESS) .....	407
3-620.13	PAYMENT - GRADUATE LEVEL COURSES.....	407
3-621	SWORN AND CORRECTIONAL EMPLOYEES' EDUCATIONAL INCENTIVE PAY PROGRAM .....	407
3-627	EQUAL EMPLOYMENT OPPORTUNITY .....	409
3-628	FILLING PERSONNEL VACANCIES .....	409
3-628.1	MOVEMENT OF PERSONNEL .....	409
3-628.2	DEFINITIONS.....	409
3-628.3	TRANSFER / REASSIGNMENT OF SWORN POLICE AND CORRECTIONAL OFFICERS - SERGEANT AND BELOW...	410
3-628.4	TRANSFER / REASSIGNMENT SELECTION PROCESS .....	411
3-628.5	CIVILIAN VACANCIES .....	411
3-628.6	CIVILIAN SELECTION PROCESS.....	413
3-628.7	PAY CONSIDERATIONS - TRANSFERS .....	413
3-630	SECONDARY EMPLOYMENT .....	413
3-630.1	APPLICABILITY .....	413
3-630.2	DEFINITIONS.....	414
3-630.3	EMPLOYEE APPLICATION PROCESS .....	414
3-630.4	SECONDARY EMPLOYMENT LOCATION APPROVAL.....	414
3-630.5	PROHIBITIONS AND RESTRICTIONS .....	415
3-630.6	LIMITATIONS.....	416
3-630.7	UNIFORMS AND VEHICLES AT SECONDARY EMPLOYMENT.....	416
3-630.8	SECONDARY EMPLOYMENT NOTIFICATION .....	416
3-630.8.1	REPORT OF POLICE ACTION .....	417
3-630.9	GAMBLING SITES.....	417
3-630.10	LIABILITY CONSIDERATIONS.....	417
3-630.11	SWORN RESPONSIBILITIES .....	417
3-630.12	NON-SWORN RESPONSIBILITIES .....	418
3-630.13	DOCUMENTING, MONITORING, AND AUDITING OF SECONDARY EMPLOYMENT.....	418
3-639	PATROL OFFICER FIELD TRAINING PROGRAM .....	418
3-639.1	PATROL FTO PROGRAM RESPONSIBILITY .....	418
3-639.2	PATROL FTO PROGRAM DESCRIPTION .....	418
3-639.3	PATROL FIELD TRAINING OFFICERS .....	419
3-640	CADET PROGRAM.....	419
3-640.1	DESCRIPTION.....	419
3-640.2	REQUIREMENTS .....	419
3-640.3	EDUCATION.....	420
3-640.4	WORK ENVIRONMENT .....	420
3-640.5	DUTIES, ROLE, AND SCOPE OF AUTHORITY .....	420
3-640.6	OPERATION OF AGENCY VEHICLES.....	421
3-640.7	TRAINING.....	421
3-640.8	AUTHORIZED UNIFORMS .....	421
3-641	EXPLORER POST #1658.....	422
3-641.1	UNIFORMS .....	422
3-642	CHARLES COUNTY SHERIFF'S OFFICE AUXILIARY VOLUNTEER PROGRAM .....	422
3-642.1	AUXILIARY VOLUNTEER QUALIFICATIONS.....	423
3-642.2	ORGANIZATION.....	423
3-642.3	AUXILIARY VOLUNTEER SERVICE .....	424
3-642.4	AUXILIARY VOLUNTEER TRAINING .....	424
3-642.5	AUXILIARY RULES AND REGULATIONS.....	425
3-642.6	PERSONAL APPEARANCE STANDARDS .....	426
3-642.7	DUTIES AND RESPONSIBILITIES .....	426
3-642.7.1	OPERATIONAL DUTIES.....	427



Administrative and Operational Manual

September 12, 2022

---

3-642.8	UNIFORMS AND EQUIPMENT.....	427
3-642.8.1	AUXILIARY VOLUNTEER RADIOS .....	428
3-642.8.2	AUXILIARY VOLUNTEER VEHICLES .....	428
3-642.9	AGENCY VEHICLE COLLISIONS .....	429
3-642.10	AUXILIARY RIDE-ALONG PROGRAM .....	429
3-642.11	AUXILIARY VOLUNTEER INJURIES .....	430
3-645	STUDENT INTERN PROGRAM .....	431
3-645.1	PROGRAM RESPONSIBILITY.....	431
3-645.2	PROGRAM ELIGIBILITY.....	431
3-645.3	OPERATIONAL PROCEDURES.....	431
<b>3-646</b>	<b>TRAINING RECORD.....</b>	<b>432</b>
3-646.1	REQUEST FOR TRAINING .....	432
3-646.2	TRAINING ASSESSMENT PROCEDURES.....	433
3-646.3	REPORT OF EXPENSES .....	433
3-646.3.1	TRANSPORTATION.....	433
3-646.3.2	LODGING .....	433
3-646.3.3	MEAL EXPENSE REIMBURSEMENT.....	434
3-646.3.4	MISCELLANEOUS ALLOWABLE EXPENSES.....	435
3-646.4	CIVILIAN TRAINING.....	435
3-646.5	POSITIONS REQUIRING SPECIALIZED TRAINING .....	436
3-646.6	REMEDIAL TRAINING.....	436
3-647	CRITICAL INCIDENT INVESTIGATION TRAINING .....	437
<b>3-650</b>	<b>EMPLOYEE PERFORMANCE EVALUATION SYSTEM .....</b>	<b>438</b>
3-650.1	DEFINITIONS.....	438
3-650.2	GENERAL PROCEDURES.....	438
3-650.3	REQUIRED RATER TRAINING.....	439
3-650.4	CORRECTIONAL OFFICER PERFORMANCE EVALUATION SYSTEM.....	439
3-650.5	SWORN POLICE OFFICER PERFORMANCE EVALUATION SYSTEM .....	442
3-650.5.1	PROBATIONARY SWORN POLICE OFFICER EVALUATION (PROBATIONARY STATUS, NON-SOLO OFFICER)..	442
3-650.5.2	SWORN POLICE OFFICER EVALUATION (PROBATIONARY STATUS, SOLO-OFFICER).....	442
3-650.5.3	NON-COMMISSIONED SWORN POLICE OFFICER EVALUATION (PERMANENT STATUS) .....	442
3-650.6	CIVILIAN PERFORMANCE EVALUATION SYSTEM .....	444
3-650.7	ANNUAL PERFORMANCE EVALUATIONS FOR MANAGEMENT AND COMMANDERS.....	445
3-650.8	PERFORMANCE EVALUATION SUPERVISORY REVIEW .....	445
3-650.9	PERFORMANCE EVALUATION CONFERENCE .....	445
3-650.10	TRANSFERS AND REASSIGNMENTS DURING RATING PERIODS .....	446
3-650.11	USE OF PERFORMANCE EVALUATION RESULTS.....	446
3-651	RATING APPEAL PROCESS.....	447
3-652	SPECIAL EVALUATION FOR UNACCEPTABLE PERFORMANCE .....	447
3-653	ANNUAL HARASSMENT AND BENEFICIARY REVIEW .....	449
<b>3-654</b>	<b>PROMOTIONS - SWORN LAW ENFORCEMENT AND CORRECTIONAL OFFICERS .....</b>	<b>449</b>
3-654.1	SECURITY AND CONFIDENTIALITY .....	450
3-654.2	APPLICATION FOR PROMOTION.....	450
3-654.3	REQUIRED ELEMENTS.....	450
3-654.4	COMPETITIVE PROCESS.....	451
3-654.4.1	RESUME COMPONENT .....	451
3-654.4.2	WRITTEN EXAMINATION .....	452
3-654.4.3	IN-BASKET EXERCISE .....	452



Administrative and Operational Manual

September 12, 2022

---

3-654.4.4	ORAL BOARD .....	452
3-654.5	APPEAL PROCESS.....	452
3-654.6	PROMOTIONAL PROCEDURES.....	452
3-654.7	PROBATIONARY POLICE OFFICER TO POLICE OFFICER II.....	452
3-654.7.1	PROBATIONARY CORRECTIONAL OFFICER I TO PROBATIONARY CORRECTIONAL OFFICER II .....	453
3-654.7.2	PROMOTION TO PFC/ CFC .....	453
3-654.7.3	PROMOTION TO CORPORAL.....	453
3-654.7.4	PROMOTION TO SERGEANT .....	454
3-654.7.5	PROMOTION TO LIEUTENANT .....	454
3-654.8	ELIGIBILITY LIST .....	454
3-654.9	SPECIAL ACCOMMODATION .....	454
3-654.10	SELECTION PROCESS.....	455
3-654.11	PROMOTION WHILE ON EXTENDED SICK AND SAFE LEAVE, INJURED IN THE LINE OF DUTY LEAVE, NON-OFFICER STATUS, OR MODIFIED DUTY - SWORN AND CORRECTIONAL OFFICERS .....	455
<b>3-655</b>	<b>EMPLOYEE’S PERSONNEL FILE .....</b>	<b>455</b>
3-655.1	ADVERSE MATERIAL .....	455
3-655.2	CONFERENCE FORMS.....	455
<b>3-656</b>	<b>AGENCY AWARDS .....</b>	<b>456</b>
3-656.1	AWARD NOMINATION .....	456
3-656.2	AWARDS COMMITTEE—ORGANIZATION AND PROCEDURES .....	456
3-656.3	AWARD SELECTION PROCESS.....	456
3-656.4	AWARDS CEREMONY AND PRESENTATION.....	457
3-656.5	TYPES OF AWARDS .....	457
3-656.6	AWARDS ACCOUTERMENTS.....	459
3-656.7	SUBSEQUENT AWARDS .....	459
3-656.8	AWARDS FROM OTHER LAW ENFORCEMENT AGENCIES .....	459
3-656.9	AWARDS PRESENTED TO THE AGENCY.....	459
<b>3-657</b>	<b>AGENCY MEMORIAL .....</b>	<b>460</b>
3-657.1	DESCRIPTION OF THE MEMORIAL .....	460
3-657.2	MEMORIAL COMMITTEE.....	460
3-657.3	RESPONSIBILITIES OF THE COMMITTEE.....	460
3-657.4	MINIMUM SERVICE TIME .....	460
3-657.5	KILLED IN THE LINE OF DUTY.....	461
3-657.6	DIED IN THE LINE OF DUTY.....	461
3-657.7	SHERIFFS OF CHARLES COUNTY.....	461
3-657.8	AGENCY RETIREES .....	461
3-657.9	MULTIPLE NAME APPEARANCE ON THE MEMORIAL.....	461
3-657.10	MAINTENANCE, REPAIR AND EXPANSION OF THE MEMORIAL .....	462
3-658	ACTUAL OR POTENTIAL CIVIL SUITS.....	462
3-658.1	EMPLOYEE PROTECTION .....	462
3-658.2	LITIGATION AND AGENCY EMPLOYEES.....	462
3-659	CONTRACT SERVICES BENEFITS .....	463
3-679	TRAIL AUDITS.....	463
3-680	PERSONNEL EARLY WARNING SYSTEM.....	464
3-680.1	FIRST LINE SUPERVISOR RESPONSIBILITIES .....	464
3-680.2	COMMAND / MANAGEMENT RESPONSIBILITIES .....	465
3-680.3	FOLLOW-UP ACTIONS .....	465
3-680.4	HUMAN RESOURCES / OPR RESPONSIBILITIES .....	466



Administrative and Operational Manual

September 12, 2022

---

3-700	ORGANIZATIONAL DISCIPLINE.....	466
3-700.1	AUTHORITY AND RESPONSIBILITY.....	466
3-700.1.1	SUPERVISORY ROLES.....	467
3-700.2	CONFIDENTIALITY.....	467
3-700.3	DEFINITIONS.....	467
3-700.4	COORDINATION OF EFFORTS.....	468
3-701	OFFICE OF PROFESSIONAL RESPONSIBILITY.....	469
3-701.1	INTERNAL AFFAIRS SECTION RESPONSIBILITIES.....	470
3-702	CITIZEN COMPLAINTS.....	470
3-702.1	RECEIVING COMPLAINTS.....	471
3-702.2	HANDLING CITIZEN COMPLAINTS.....	471
3-702.3	FORM OF COMPLAINT.....	472
3-703	COMPLAINT INVESTIGATION.....	472
3-703.1	COMPLAINTS THAT ARE NOT COMPLAINTS OF MISCONDUCT INVOLVING A MEMBER OF THE PUBLIC.....	472
3-703.2	INTERNAL COMPLAINTS.....	473
3-703.3	HARASSMENT OF WITNESS.....	473
3-704	DISCIPLINE - CORRECTIONAL EMPLOYEES AND SWORN EMPLOYEES FOR COMPLAINTS OTHER THAN COMPLAINTS OF MISCONDUCT INVOLVING A MEMBER OF THE PUBLIC.....	473
3-704.1	PROGRESSION OF DISCIPLINE.....	473
3-704.1.1	LETTER OF REPRIMAND/ WRITTEN WARNING.....	473
3-704.1.2	DISCIPLINARY DISPOSITION REPORT (DDR).....	474
3-704.1.3	ADMINISTRATIVE CHARGES.....	475
3-704.1.4	FINES VERSUS RESTITUTION.....	475
3-706	DISCIPLINARY MATRIX - SWORN AND CORRECTIONAL OFFICERS.....	476
3-708	SUSPENSIONS OF POLICE POWERS/ CORRECTIONAL OFFICER AUTHORITY.....	489
3-708.1	DISCIPLINARY SUSPENSIONS.....	490
3-708.2	DISCRETIONARY SUSPENSION.....	491
3-708.3	MANDATORY SUSPENSION.....	491
3-708.4	METHOD OF SUSPENSION.....	492
3-708.5	SUSPENSION HEARINGS.....	492
3-708.6	RESPONSIBILITIES OF THE HEARING OFFICER.....	492
3-709	EXCESSIVE FORCE COMPLAINTS - CORRECTIONS.....	493
3-710	ARREST OF EMPLOYEES.....	493
3-711	ADMINISTRATIVE HEARING BOARD (AHB).....	493
3-711.1	OFFICE OF PROFESSIONAL RESPONSIBILITY (OPR).....	493
3-711.1.1	INFORMATION TECHNOLOGY DIVISION.....	494
3-711.2	RESPONDENT APPEARANCE AT AHB.....	494
3-711.3	REQUIRED ATTENDANCE BEFORE THE AHB.....	494
3-711.4	CONTINUANCES.....	494
3-711.5	CONSTRUCTION OF THE AHB.....	495
3-711.6	DUTIES OF BOARD MEMBERS.....	495
3-711.7	RESPONDENT PRIVILEGES.....	495
3-711.8	WAIVER OF RIGHTS.....	495
3-711.9	AHB ORDER OF PRESENTATION AND PROCESSES.....	495
3-712	RECOMMENDATION FOR SUSPENSION.....	496
3-712.1	RECOMMENDATION FOR TERMINATION.....	496
3-713	FINAL ORDER OF THE SHERIFF.....	496
3-713.1	EMPLOYEE TERMINATION.....	497
3-713.2	APPEAL OF FINAL ORDER.....	497
3-714	WITNESS FEES.....	497
3-715	EXPUNGEMENT - SWORN/ CORRECTIONAL RESPONDENTS.....	497





Administrative and Operational Manual

September 12, 2022

3-716 INVESTIGATION AND DISCIPLINARY PROCESS FOR COMPLAINTS OF MISCONDUCT INVOLVING A MEMBER OF THE PUBLIC 497

3-717 DISCIPLINARY PROCEDURES - CIVILIAN EMPLOYEES .....499

3-717.1 SCOPE OF POLICY .....499

3-717.2 RESTITUTION .....499

3-717.3 ABSENT WITHOUT AUTHORIZATION (AWOL).....499

3-717.4 EMERGENCY SUSPENSION .....500

3-717.5 MISCONDUCT.....500

3-717.6 SUPERVISORY/ MANAGEMENT RESPONSIBILITIES.....501

3-717.7 LEVELS OF DISCIPLINE.....502

3-717.7.1 REMEDIAL TRAINING .....502

3-717.7.2 FORMAL COUNSELING.....502

3-717.7.3 LETTER OF REPRIMAND .....503

3-717.7.4 SUSPENSION WITHOUT PAY .....504

3-717.7.5 TERMINATION .....504

3-717.7.6 APPEAL OF DISCIPLINARY ACTION .....505

3-717.7.7 DISCIPLINARY ACTION - CALCULATION OF EFFECTIVE DATE.....505

3-717.8 EXPUNGEMENT PROCEDURES .....505

3-717.9 NAME CLEARING HEARINGS FOR EMPLOYEES NOT ENTITLED TO THE DISCIPLINE PROCESS .....506

3-750 EMPLOYEE GRIEVANCE PROCESS .....507

3-750.1 DEFINITIONS.....507

3-750.2 EXCLUSIONS .....507

3-750.3 GRIEVANCE PROCEDURES.....508

3-750.3.1 INFORMAL GRIEVANCE PROCEDURES .....508

3-750.3.2 FORMAL GRIEVANCE PROCEDURES.....508

3-750.3.3 GRIEVANCE REVIEW BOARD .....509

3-750.3.4 APPEAL PROCEDURES.....510

3-750.4 GRIEVANCE PROCESS TIME LIMITS.....510

3-750.5 REPRESENTATION .....510

3-750.6 ADMINISTRATION .....511

**3-800 USE OF FORCE POLICY .....511**

3-800.1 DEFINITIONS.....511

3-800.2 AUTHORIZATION TO USE FORCE AND REQUIRED TRAINING .....513

3-800.3 MEDICAL AID .....513

3-800.4 LETHAL FORCE.....514

3-800.5 PROHIBITED USE OF FORCE .....514

**3-810 USE OF FIREARMS .....514**

3-810.1 AUTHORIZED USE OF FIREARMS.....514

**3-810.2 SHOOTING AT OR FROM A MOVING VEHICLE.....515**

**3-810.3 CARRYING OF FIREARMS BY PERSONS AUTHORIZED BY LAW .....515**

**3-820 SHERIFF’S AUTHORIZATION TO CARRY FIREARMS .....515**

3-820.1 DEFINITIONS.....515

3-820.2 SWORN POLICE/ CORRECTIONAL OFFICERS’ RESPONSIBILITIES.....516

3-820.3 FIREARMS RANGE USE.....517

3-820.3.1 RANGE SAFETY .....517

3-820.4 AUTHORIZED FIREARMS.....518

3-820.4.1 DUTY FIREARMS .....518

3-820.4.2 USE OF ALTERNATE FIREARMS WHILE ON DUTY .....518



Administrative and Operational Manual

September 12, 2022

---

3-820.5	SPECIFICATIONS FOR OFF-DUTY FIREARMS.....	519
3-820.5.1	MODIFICATIONS TO FIREARMS.....	519
3-820.6	PERSONALLY OWNED FIREARMS .....	520
3-820.7	AUTHORIZED AMMUNITION .....	521
3-820.8	FIREARMS QUALIFICATION .....	521
3-820.9	MARKSMANSHIP BADGES .....	522
3-820.10	FIREARMS ISSUANCE.....	522
3-820.11	FIREARMS INSTRUCTORS .....	523
3-820.12	LOST, STOLEN OR SEIZED FIREARMS .....	523
3-820.13	FIREARMS INSPECTIONS.....	523
3-820.14	HOME STORAGE OF FIREARMS .....	524
3-820.15	UNLOADING CONTAINMENT DEVICES .....	524
3-820.16	SALE OF AGENCY HANDGUNS TO EMPLOYEES .....	524
3-820.17	ACCIDENTAL DISCHARGE OF FIREARMS .....	525
3-820.18	SHOTGUNS.....	526
3-820.19	EMERGENCY SERVICES TEAM FIREARMS .....	527
<b>3-821</b>	<b>AGENCY RIFLES.....</b>	<b>527</b>
3-821.1	TRAINING AND QUALIFICATION .....	527
3-821.2	RIFLE DEPLOYMENT GUIDELINES .....	527
3-821.3	TRANSPORTATION AND STORAGE.....	528
3-821.4	MAINTENANCE AND CARE OF RIFLES.....	528
<b>3-830</b>	<b>USE OF WEAPONS OTHER THAN FIREARMS .....</b>	<b>529</b>
3-830.1	BATONS.....	529
3-830.2	AEROSOL SUBJECT RESTRAINTS (ASR) .....	529
3-830.3	CHEMICAL WEAPONS.....	529
<b>3-831</b>	<b>CONDUCTED ENERGY WEAPONS (CEWS) .....</b>	<b>529</b>
3-831.1	TRAINING AND USE .....	530
3-831.2	WEAR AND CARRY / CARE AND MAINTENANCE OF THE CEW.....	530
3-831.3	USE OF A CEW .....	530
3-831.4	POST DEPLOYMENT CONSIDERATIONS.....	531
3-832	STUN-CUFFS.....	532
3-835	FN-303 PROJECTILE LAUNCHER.....	532
3-835.1	TRAINING .....	532
3-835.2	STORAGE AND MAINTENANCE.....	532
3-835.3	OPERATIONAL GUIDELINES.....	533
<b>3-837</b>	<b>USE OF FORCE REPORTING .....</b>	<b>533</b>
3-837.1	USE OF FORCE REPORTING REQUIREMENTS.....	533
3-837.2	USE OF FORCE REPORTING RESPONSIBILITIES.....	535
<b>3-838</b>	<b>FATAL OR SERIOUS PHYSICAL INJURIES .....</b>	<b>538</b>
<b>3-839</b>	<b>INJURED WILD ANIMAL TERMINATION .....</b>	<b>538</b>
<b>3-840</b>	<b>USE OF FORCE ON DOMESTIC ANIMAL .....</b>	<b>539</b>
<b>3-841</b>	<b>VICIOUS OR DANGEROUS ANIMALS.....</b>	<b>539</b>
<b>3-842</b>	<b>SUSPECTED RABID ANIMALS .....</b>	<b>539</b>



Administrative and Operational Manual

September 12, 2022

3-842.1 SHOOTING OF RABID ANIMALS ..... 540

3-842.2 RESPONSIBILITIES SUBSEQUENT TO SHOOTING RABID ANIMALS ..... 540

3-842.3 ADDITIONAL RESPONSIBILITIES IN RABID ANIMAL CASES ..... 540

3-850 FIREARMS QUALIFICATION FOR RETIRED LAW ENFORCEMENT OFFICERS ..... 541

3-850.1 QUALIFICATION OF RETIRED OFFICERS ..... 541

3-850.2 FIREARMS AND AMMUNITION FOR RETIRED OFFICERS QUALIFICATION ..... 541

3-850.3 FEE FOR QUALIFICATION ..... 541

3-850.4 QUALIFICATION CARDS FOR RETIRED OFFICERS..... 541

3-850.5 RETIRED OFFICER QUALIFICATION APPLICATION FORM #72A USAGE ..... 542

3-850.6 COLLECTION OF QUALIFICATION FEES ..... 542

**CHAPTER 4 – AGENCY OPERATIONS ..... 543**

**4-100 COMMUNICATIONS SECTION ..... 543**

4-100.1 DEFINITIONS..... 543

4-101 COMMUNICATIONS PROCEDURES ..... 543

4-101.1 DESIGNATOR CODES - AGENCY PERSONNEL..... 546

4-101.2 DESIGNATOR CODES - NON- AGENCY PERSONNEL..... 547

4-101.3 JOINT OPERATIONS ..... 547

4-101.4 MOVING TO A TACTICAL TALK GROUP..... 547

4-101.5 RADIO USAGE-TALK GROUP ASSIGNMENTS..... 548

4-101.6 10-3 STOP TRANSMISSIONS ..... 548

4-101.7 OFFICER IN DISTRESS (SIGNAL 13)..... 549

4-101.8 PHONETIC ALPHABET ..... 549

4-101.9 RADIO CODE LIST..... 549

4-101.10 CLEARING CALLS- DISPOSITION ..... 549

4-101.11 RADIO COMPLETION CODES ..... 550

4-101.12 FALSE ALARM AND BUILDING COMPLETION CODES..... 550

4-101.13 REPORTING DISTRICTS..... 550

4-101.14 COVERAGE AREAS ..... 550

4-102 CHARLES COUNTY SHERIFF’S OFFICE JURISDICTIONAL BOUNDARIES ..... 551

4-103 AGENCY TELEPHONE USAGE ..... 551

4-103.1 USE OF AGENCY LAND-LINE PHONES ..... 551

4-103.2 RESTRICTED USED OF CELL PHONES/WIRELESS DEVICES ..... 551

4-103.3 911 LINES..... 552

4-103.3.1 CCSO NON-EMERGENCY LINES - DISTRICT STATIONS ..... 553

4-103.3.2 DIRECT LINES ..... 553

4-104 FACSIMILE UNIT (FAX MACHINE)..... 554

4-105 INCIDENT COMMAND AND COMMUNICATIONS (ICCV) VEHICLE..... 554

4-105.1 ICCV DEPLOYMENT ..... 554

4-105.2 REQUESTS FOR DEPLOYMENT BY OTHER AGENCIES ..... 555

4-105.3 ICCV CARE AND MAINTENANCE ..... 555

4-106 REVERSE 911 - CITIZENS NOTIFICATION SYSTEM..... 556

4-106.1 PROCEDURES FOR INITIATING A REVERSE 911 SESSION..... 556

4-106.2 TIME CRITICAL SESSIONS..... 556

**4-107 AGENCY NOTIFICATION SERVICE ..... 557**

4-109 SILENT ALARM RESPONSE ..... 557

4-109.1 OFFICER RESPONSE ..... 557

4-109.2 COMMUNICATIONS’ RESPONSIBILITIES ..... 558

**4-110 INTERPRETERS / TRANSLATORS SERVICES ..... 559**



Administrative and Operational Manual

September 12, 2022

---

4-110.1	BILINGUAL EMPLOYEES.....	559
4-110.2	DEAF / HARD-OF-HEARING INDIVIDUALS.....	559
4-110.3	SIGN LANGUAGE INTERPRETERS.....	560
<b>4-111</b>	<b>EMERGENCY RESPONSE CLASSIFICATIONS AND GUIDELINES.....</b>	<b>561</b>
4-111.1	RESPONSE CLASSIFICATIONS.....	561
4-111.2	GENERAL RESPONSE ASSIGNMENT GUIDELINES.....	562
4-111.2.1	INOPERABLE EMERGENCY EQUIPMENT.....	562
4-111.3	GENERAL DISPATCH GUIDELINES FOR PRIORITY RESPONSE INCIDENTS.....	562
4-111.3.1	SELF INITIATED PRIORITY RESPONSES.....	562
[REDACTED]	[REDACTED]	
[REDACTED]	[REDACTED]	
4-111.5	NEXT-OF-KIN NOTIFICATIONS.....	564
[REDACTED]	[REDACTED]	
[REDACTED]	[REDACTED]	
<b>4-112</b>	<b>FALSE ALARM ORDINANCE.....</b>	<b>566</b>
4-112.1	NOTIFICATION FORMS.....	566
4-112.2	RESPONSE TO ALARMS.....	567
4-112.3	COMPLETION OF THE FALSE ALARM NOTIFICATION FORM.....	567
4-112.4	WEATHER.....	568
4-112.5	CONTACT WITH RESIDENT OR EMPLOYEE.....	568
4-112.6	FINAL DISPOSITION OF FORMS.....	568
<b>4-113</b>	<b>NOISE CONTROL ORDINANCE ENFORCEMENT.....</b>	<b>569</b>
4-113.1	DEFINITIONS.....	569
4-113.2	TRAINING, CERTIFICATION, AND MAINTENANCE.....	570
4-113.3	INVESTIGATION AND ENFORCEMENT.....	571
4-113.4	NOISE EXCEEDING MEASURABLE STANDARDS.....	571
4-113.5	EXEMPTIONS.....	572
4-113.6	DOCUMENTATION.....	573
<b>4-115</b>	<b>COMMAND INFORMATION.....</b>	<b>574</b>
4-115.1	INITIAL NOTIFICATION AND OVERVIEW "CRIME REPORTS".....	574
4-115.2	COMMANDERS' INFORMATION REPORT.....	575
4-115.3	COMMANDERS' RESPONSIBILITY.....	575
4-115.4	COMPUTER SYSTEM OUTAGES.....	576
<b>4-116</b>	<b>METERS / NCIC COMPUTER SYSTEM.....</b>	<b>577</b>
4-116.1	RESPONSIBILITY.....	577
4-117	AUTHORIZED PERSONNEL TO OPERATE.....	577
4-118	GENERAL RESPONSIBILITIES.....	577
4-119	COMPUTER INFORMATION TRACKING.....	577
4-120	COMPSTAT PROGRAM.....	578
<b>4-205</b>	<b>ASSISTING / TRANSPORTING INTOXICATED OR INCAPACITATED PERSONS.....</b>	<b>579</b>
4-205.1	PROCEDURES – MAN-DOWN CALLS.....	579
4-205.2	CHECKING FOR MEDIC ALERT WARNING.....	579
<b>4-206</b>	<b>DEPARTMENT OF SOCIAL SERVICES.....</b>	<b>579</b>
4-206.1	ASSISTANCE CAPABILITY.....	579



Administrative and Operational Manual

September 12, 2022

4-206.2 REQUEST FOR ASSISTANCE.....579

[Redacted content]

4-209 UNMANNED AERIAL SYSTEM (UAS).....584

[Redacted content]

[Redacted content]

[Redacted content]

4-212 ASSISTING MOTORISTS .....594

4-213 VEHICLE LOCKOUTS.....594

4-213.1 EMERGENCY ENTRY.....594

4-213.2 REQUIRED REPORT.....595

4-214 POLICE ACTIVITIES ON PUBLIC SCHOOL PROPERTY .....595

4-214.1 GENERAL PATROL PROCEDURES .....595

4-214.2 ARREST ON SCHOOL PROPERTY DURING SCHOOL HOURS .....595

4-214.3 QUESTIONING ON SCHOOL PREMISES .....595

4-214.4 SEARCH AND SEIZURE ON SCHOOL PROPERTY .....596

4-214.5 SCHOOL DISORDERS - REQUEST FOR POLICE RESPONSE .....596

4-215 TOW SERVICE PROGRAM.....597



Administrative and Operational Manual

September 12, 2022

4-215.1 LIST OF APPROVED TOW SERVICE OPERATORS .....598

4-216 CCSO AUTHORIZED TOW SERVICES; REQUIREMENTS, RULES, REGULATIONS AND SCHEDULE OF FEES FOR SERVICES, AND APPLICATION .....598

**4-217 STORAGE OF VEHICLES.....599**

4-217.1 VEHICLES INVOLVED IN ACCIDENTS .....599

4-217.2 ILLEGALLY PARKED VEHICLES .....599

4-217.3 OPERATOR ARRESTED .....600

4-217.4 DIPLOMATIC VEHICLES.....600

4-217.5 VEHICLES WITH DEFECTIVE EQUIPMENT.....600

4-217.6 RECOVERED STOLEN VEHICLES.....600

4-217.7 VEHICLES WITH MISSING OR ALTERED VEHICLE IDENTIFICATION NUMBERS.....600

4-217.8 PERSONS TO PROVE AUTHORIZED POSSESSION.....600

**4-217.9 VEHICLES STORED FOR EVIDENTIARY PURPOSES.....601**

4-217.10 NARCOTIC RELATED STORAGE .....602

4-217.11 ABANDONED VEHICLE / INOPERABLE, PUBLIC OR PRIVATE PROPERTY .....602

4-217.12 UNATTENDED / DISABLED VEHICLES ON PUBLIC PROPERTY .....602

4-217.13 VEHICLES ON PRIVATE PROPERTY .....603

4-217.14 OFFICER’S RESPONSIBILITIES WHEN TOWING VEHICLES.....603

4-217.14.1 OFFICER’S RESPONSIBILITIES WHEN STORING VEHICLES.....603

4-217.15 STORED VEHICLE OF UNKNOWN OWNER(S) .....604

4-217.16 ISSUANCE OF VEHICLE RELEASE .....604

4-217.17 RELEASE FOLLOWING REQUEST FOR TOWING SERVICES .....605

4-217.18 GENERAL VEHICLE STORAGE GUIDELINES.....605

4-217.19 VEHICLE INVENTORY PROCEDURES.....605

**4-218 RESERVED PARKING AT HEADQUARTERS AND THE DETENTION CENTER.....607**

4-218.1 GENERAL POLICY .....607

**4-219 USE OF AGENCY VEHICLES .....608**

4-219.1 MANDATORY USE OF SAFETY RESTRAINT DEVICES .....608

4-219.2 EMPLOYEE VEHICLE ASSIGNMENTS .....608

4-219.3 REQUESTING AUTHORIZATION TO DRIVE AGENCY VEHICLES OUT OF CHARLES COUNTY.....609

4-219.4 OFF-DUTY USE OF ASSIGNED VEHICLES.....609

4-219.5 CONDITIONS OF USE .....610

4-219.6 OFF-DUTY VEHICLE USE DRESS CODE .....611

4-219.7 PERSONS TO BE ALLOWED IN SHERIFF’S VEHICLES.....612

4-219.8 ANIMALS IN VEHICLES.....612

4-219.9 RESPONSE TO INCIDENTS WHILE PASSENGERS ARE ABOARD .....612

4-219.10 SUPERVISORY RESPONSIBILITIES.....613

4-219.11 PARKING REGULATIONS.....613

4-219.12 VEHICLE ESCORTS.....614

4-219.13 SURVEILLANCE VEHICLES .....614

4-220 OPERATION OF AGENCY MOTORCYCLES.....614

4-220.1 PROHIBITIONS.....615

4-220.2 OFF-DUTY USE OF MOTORCYCLES.....615

**4-222 VEHICLE SERVICE PROCEDURES .....615**

**4-222.1 VEHICLE REPAIR.....616**

**4-222.2 VEHICLE EMISSIONS.....616**

**4-222.3 FUELING PROCEDURES AND CONSUMPTION CONSERVATION.....617**



Administrative and Operational Manual

September 12, 2022

---

**4-222.4 OIL USAGE ..... 617**

**4-222.5 VEHICLE EQUIPMENT ..... 617**

**4-222.6 OPERATOR-INSTALLED EQUIPMENT ..... 618**

4-223 MONTHLY MILEAGE REPORT ..... 619

4-223.1 MONTHLY VEHICLE INSPECTIONS ..... 619

4-223.2 SPEEDOMETER CERTIFICATION ..... 619

4-223.3 MANDATORY VEHICLE INSPECTION ..... 620

4-224 UNASSIGNED (POOL) VEHICLES ..... 620

**4-225 DIGITAL MOBILE VIDEO/ AUDIO RECORDERS (DMVR) ..... 620**

4-225.1 DMVR EQUIPMENT INSTALLATION, MAINTENANCE AND ROUTINE CARE ..... 621

4-225.2 DMVR EQUIPMENT FUNCTIONS AND USE ..... 622

4-225.3 RECORDING GUIDELINES ..... 623

4-225.4 REVIEW, RETENTION, AND STORAGE OF RECORDINGS ..... 624

4-225.5 COPYING RECORDINGS ..... 624

4-225.5.1 IN-AGENCY REQUEST FOR COPY OF A RECORDING ..... 625

**4-226 PATROL CHECKS ..... 625**

4-226.1 SUPERVISOR'S RESPONSIBILITIES ..... 625

**4-227 ARREST WARRANTS / CRIMINAL CHARGING DOCUMENTS - FILING AND ACCESS ..... 625**

**4-228 NARCAN (NALOXONE) ..... 626**

4-228.1 TRAINING ..... 626

4-228.2 ISSUANCE, MAINTENANCE, AND REPLACEMENT ..... 626

4-228.3 INDICATIONS AND USE ..... 626

4-228.4 REPORTING REQUIREMENTS ..... 626

**4-229 EXCITED DELIRIUM / SUDDEN IN-CUSTODY DEATH / MEDICAL EMERGENCY ..... 627**

4-229.1 RECOGNIZING EXCITED DELIRIUM ..... 627

4-229.2 INCIDENT MANAGEMENT ..... 628

4-229.3 COMMUNICATIONS ROLE ..... 628

4-229.4 OFFICER'S ROLE ..... 628

4-229.5 REPORTING AND INVESTIGATION ..... 629

4-229.6 TRAINING ..... 630

**4-231 RESPONSE TO PEOPLE WITH MENTAL ILLNESSES ..... 632**

4-231.1 DEFINITIONS ..... 632

4-231.2 TRAINING ..... 633

4-231.3 RECOGNIZING CHARACTERISTICS OF MENTAL ILLNESSES ..... 633

4-231.4 POLICE COMMUNICATIONS OFFICERS RESPONSIBILITIES ..... 633

4-231.5 RESPONSE TO CALLS FOR SERVICE INVOLVING PEOPLE WITH MENTAL ILLNESSES ..... 634

4-231.6 COMMUNITY RESOURCES ..... 636

**4-232 EMERGENCY PSYCHIATRIC EVALUATION PETITIONS ..... 637**

4-232.1 DEFINITIONS ..... 637

4-232.2 EMERGENCY FACILITIES ..... 637

4-232.3 PETITION FOR EMERGENCY EVALUATION ..... 638

4-232.3.1 EMERGENCY PETITION AT THE CHARLES COUNTY DETENTION CENTER ..... 638

4-232.4 DUTY OF PEACE OFFICER ..... 639

4-232.5 JUDICIAL SERVICES ..... 639

4-232.6 ARREST ALTERNATIVE ..... 640



Administrative and Operational Manual

September 12, 2022

---

4-232.7	PETITIONS INITIATED BY OFFICERS.....	640
4-232.8	SERVING PETITIONS NOT INITIATED BY AN OFFICER .....	641
4-232.9	COMPLETION OF REQUIRED REPORT .....	641
4-232.10	LAY PETITIONERS.....	641
4-232.11	DISTRIBUTION OF SERVED PETITIONS .....	642
<b>4-233</b>	<b>DOMESTIC VIOLENCE .....</b>	<b>643</b>
<b>4-233.1</b>	<b>DISPATCHING COMPLAINT OF DOMESTIC VIOLENCE .....</b>	<b>643</b>
4-233.2	RESPONDING OFFICER PROCEDURES AND RESPONSIBILITIES.....	643
4-233.3	LETHALITY ASSESSMENT PROGRAM (LAP) .....	645
4-233.4	CENTER FOR ABUSED PERSONS REFERRAL.....	645
4-233.5	WARRANTLESS ARRESTS FOR MISDEMEANOR ASSAULTS.....	646
4-233.6	ORDERS FOR PROTECTION (INTERIM, TEMPORARY, AND FINAL).....	646
4-233.7	INTERIM PROTECTIVE ORDERS.....	647
4-233.8	INTERIM PROTECTIVE ORDER PROCEDURES .....	648
4-233.9	TEMPORARY AND FINAL PROTECTIVE ORDER PROCEDURES.....	649
4-233.10	VIOLATIONS OF PROTECTIVE ORDERS.....	649
4-233.10.1	NON-ARRESTABLE PROTECTIVE ORDER VIOLATIONS.....	650
4-233.11	OUT-OF-STATE PROTECTIVE ORDERS.....	650
4-233.12	REMOVAL OF FIREARMS .....	651
4-233.13	DOMESTIC STANDBYS .....	652
4-233.14	DOMESTIC VIOLENCE INVOLVING LAW ENFORCEMENT OFFICERS .....	652
4-233.15	PEACE ORDERS .....	653
4-233.15.1	INTERIM PEACE ORDER.....	654
4-233.15.2	PROCEDURES.....	654
4-233.15.3	TEMPORARY PEACE ORDER.....	655
4-233.15.4	VIOLATIONS OF PEACE ORDERS.....	655
4-233.17	DOMESTIC VIOLENCE REPORTING PROCEDURES .....	656
4-233.18	DOMESTIC VIOLENCE UNIT .....	656
4-233.19	STEPS TO EFFECTIVE DOMESTIC VIOLENCE INTERVENTION .....	657
<b>4-234</b>	<b>EXTREME RISK PROTECTIVE ORDER .....</b>	<b>657</b>
4-234.1	PURPOSE .....	657
4-234.2	DEFINITIONS.....	657
4-234.3	DETERMINING WHEN AN ERPO IS APPROPRIATE.....	658
4-234.4	LAW ENFORCEMENT RESPONSE .....	659
4-234.5	REPORTING REQUIREMENTS.....	660
4-234.6	COURT PROCEEDINGS.....	661
4-234.7	SERVICE OF INTERIM AND TEMPORARY ERPO ORDERS – CITIZENS ERPOS.....	661
4-234.8	SEIZING FIREARMS AND AMMUNITION UNDER AN ERPO.....	662
4-234.9	RESPONSIBILITY UPON TAKING POSSESSION OF FIREARMS AND AMMUNITION.....	663
4-234.10	EXPIRATION OF THE ERPO .....	663
4-234.11	VIOLATIONS OF AN ERPO .....	664
4-234.12	TRANSFER OF FIREARMS UPON CONVICTION OF DOMESTICALLY RELATED CRIME .....	664
4-234.13	RECEIVING TRANSFERRED FIREARMS.....	664
4-234.14	COMPLIANCE WITH THE COURT ORDER.....	664
4-234.15	REPORTING REQUIREMENTS .....	665
4-234.16	SEARCH WARRANTS.....	665
4-234.17	STORAGE OF TRANSFERRED FIREARMS .....	665
4-235.1	REPORTING .....	667





Administrative and Operational Manual

September 12, 2022

4-236 MISSING PERSON CASES AND REPORTING .....667

4-236.1 DEFINITIONS.....667

4-236.2 SEARCH MANAGEMENT FUNCTION (TEAM) .....669

4-236.3 COMMUNICATIONS SECTION RESPONSIBILITIES .....669

4-236.4 RESPONDING OFFICER’S RESPONSIBILITIES – CRITICAL MISSING .....669

4-236.5 SUPERVISOR’S RESPONSIBILITIES – CRITICAL MISSING .....669

4-236.6 COMMANDER’S RESPONSIBILITIES – CRITICAL MISSING .....670

4-236.7 SEARCH MANAGEMENT FUNCTION – RESPONSIBILITIES .....670

4-236.8 CID RESPONSIBILITIES – CRITICAL MISSING .....670

4-236.9 PRELIMINARY INVESTIGATION CHECKLIST FOR CRITICAL MISSING PERSONS .....671

4-236.10 NON-CRITICAL MISSING PERSON CASES.....672

4-236.11 UNIDENTIFIED PERSON CASES.....672

4-236.12 ACTIVATION OF THE MARYLAND AMBER PLAN.....672

4-236.13 ACTIVATION OF THE SILVER ALERT PROGRAM.....673

4-236.14 PROJECT LIFESAVER.....674

4-237 SUSPENSION ROUTINE PATROL DUE TO ADVERSE WEATHER CONDITIONS.....674

4-237.1 GUIDELINES.....674

4-237.2 CANCELLATION OF SUSPENSION OF ROUTINE PATROL.....675

4-238 YELLOW ALERT PROGRAM.....675

4-238.1 DEFINITIONS.....675

4-238.2 BACKGROUND.....675

4-238.3 REQUESTING AN ALERT .....675

4-238.4 DEACTIVATING AN ALERT.....676

4-239 POLICY CONCERNING DIPLOMATIC IMMUNITY .....676

4-239.1 DIPLOMATIC IMMUNITY DEFINED .....676

4-239.2 GENERAL PROCEDURES - CONTACTS WITH PERSONS CLAIMING DIPLOMATIC IMMUNITY .....676

4-239.3 ASSAULT ON OFFICER BY DIPLOMAT .....677

4-239.4 VEHICLES WITH DIPLOMATIC TAGS OR OWNED BY INDIVIDUALS CLAIMING DIPLOMATIC IMMUNITY .....677

4-239.5 GENERAL TRAFFIC ENFORCEMENT AND DIPLOMATIC IMMUNITY .....677

4-239.6 MOVING VIOLATIONS AND SERIOUS TRAFFIC INCIDENTS.....677

4-239.7 MARYLAND TRANSPORTATION ARTICLE REQUIREMENTS .....678

4-239.8 PARKING VIOLATIONS - VEHICLES BEARING DIPLOMATIC TAGS .....678

4-239.9 NOTIFICATION IN CASE OF SERIOUS INJURY OR DEATH TO DIPLOMAT .....678

4-239.10 DEPARTMENT OF STATE CONTACTS.....678

[Redacted text]

[Redacted text]

[Redacted text]

4-241 CRIME SOLVER TIP LINE .....679

4-241.1 PROCEDURES - REWARD OFFERED.....680

4-241.2 PERSONAL USE PROHIBITED.....680

[Redacted text]

[Redacted text]

[Redacted text]

[Redacted text]

[Redacted text]



Administrative and Operational Manual

September 12, 2022

**4-244 RACIAL, RELIGIOUS, ETHNIC, SEXUAL ORIENTATION, AND DISABILITY BIAS (HATE CRIMES) .....683**

4-244.1 DEFINITIONS.....683

4-244.2 DETERMINATION OF INCIDENT .....683

4-244.3 RELATED CRIMINAL ACTS .....683

4-244.4 OFFICER’S RESPONSIBILITIES.....685

4-244.5 SUPERVISOR’S RESPONSIBILITIES.....685

4-244.6 COMMANDER, CRIMINAL INVESTIGATIONS DIVISION RESPONSIBILITIES.....686

4-244.7 DISTRICT / SHIFT COMMANDER’S RESPONSIBILITIES .....686

**4-245 CIVIL OR CRIMINAL PROCESS ON INMATES .....686**

4-245.1 PURPOSE .....686

4-245.2 GENERAL .....686

4-246 RETURNS OF CIVIL PROCESS .....687

**4-248 EXTRA - JURISDICTIONAL INCIDENTS OUTSIDE CHARLES COUNTY (CRIMINAL PROCEDURE, TITLE 2).....688**

4-248.1 GENERAL .....688

4-248.2 DEFINITIONS (APPLY TO SECTIONS 4-248 AND 4-249) .....688

4-248.3 EXTRA - JURISDICTIONAL AUTHORITY OF OFFICERS .....688

4-248.4 NOTIFICATIONS .....689

4-248.5 TRANSPORTING PRISONERS.....689

4-248.6 TRANSFER OF INVESTIGATIVE RESPONSIBILITY.....690

4-248.7 PROCESSING AND REPORTS .....690

4-248.8 DISTRICT COMMANDER RESPONSIBILITIES.....691

4-248.9 SCHEDULED PRISONER TRANSPORTS.....691

**4-249 EXTRA - JURISDICTIONAL INCIDENTS INSIDE CHARLES COUNTY (CRIMINAL PROCEDURE, TITLE 2) .....692**

4-249.1 GENERAL .....692

4-249.2 NOTIFICATIONS AND REPORTS.....692

4-249.3 TRANSFER OF INVESTIGATIVE RESPONSIBILITY.....693

**4-250 FOOT PURSUIT POLICY .....693**

4-250.1 DEFINITIONS.....693

4-250.2 JUSTIFIED PURSUITS.....694

4-250.3 OFFICER, COMMUNITY AND SUSPECT SAFETY .....694

**4-251 DECISION TO PURSUE .....694**

4-251.1 PROHIBITED ACTIONS.....695

4-251.2 PURSUIT GUIDELINES .....695

**4-252 RESPONSIBILITIES IN FOOT PURSUITS .....696**

4-252.1 INITIATING OFFICER RESPONSIBILITIES .....696

4-252.2 RESPONSIBILITIES FOR FOOT PURSUITS INVOLVING TWO OR MORE OFFICERS .....696

4-252.3 BACKUP OFFICERS’ RESPONSIBILITIES.....697

4-252.4 TERMINATING A FOOT PURSUIT .....697

4-252.5 SUPERVISOR RESPONSIBILITIES.....697

**4-253 COMMUNICATIONS SECTION RESPONSIBILITIES .....698**

**4-254 REPORTING REQUIREMENTS.....698**

**4-300 TRAFFIC ENFORCEMENT .....700**

4-300.1 TRAFFIC AND PARKING CITATIONS BOOKS.....700



Administrative and Operational Manual

September 12, 2022

---

4-300.1.1	ISSUED CITATIONS.....	701
4-300.1.2	VOIDING CITATIONS.....	701
4-300.2	INVESTIGATIVE AND ENFORCEMENT TRAFFIC STOPS.....	701
4-300.2.1	DEFINITIONS.....	702
4-300.2.2	TRAINING.....	702
4-300.2.3	COURT CASE REFERENCES.....	702
4-300.2.4	TRAFFIC STOP DATA SHEET.....	703
4-300.3	TRAFFIC STOP PROCEDURES.....	706
4-300.3.1	PLAINCLOTHES TRAFFIC STOPS.....	706
4-300.3.2	JUVENILE TRAFFIC CHARGES.....	707
4-300.3.3	ROUTINE TRAFFIC STOPS WHILE IN ANOTHER JURISDICTION.....	707
4-300.4	TRAFFIC VIOLATIONS - NON-MARYLAND RESIDENTS.....	707
4-300.4.1	TRAFFIC VIOLATIONS - LEGISLATORS.....	707
4-300.4.2	TRAFFIC VIOLATIONS - MILITARY PERSONNEL.....	707
4-300.5	TRAFFIC WARNING NOTICES.....	708
4-300.5.1	WARNING NOTICE DISTRIBUTION.....	708
4-300.6	SPEED VIOLATIONS.....	708
4-300.6.1	HAZARDOUS VIOLATIONS.....	708
4-300.6.2	DRIVING WHILE SUSPENDED OR REVOKED.....	708
4-300.6.3	OFF - ROAD VIOLATIONS.....	709
4-300.6.4	PEDESTRIAN AND BICYCLE VIOLATIONS.....	709
4-300.7	VEHICLE EQUIPMENT VIOLATIONS.....	709
4.300.7.1	DISTRIBUTION.....	709
4-300.7.2	CERTIFICATION OF SAFETY EQUIPMENT REPAIR ORDER.....	709
4-300.7.3	PROCEDURES FOR COMPLETING CERTIFICATION.....	710
4-300.7.4	ISSUING CITATIONS FOR DEFECTIVE EQUIPMENT.....	710
4-300.8	REQUEST FOR RE-EXAMINATION OF DRIVER.....	710
<b>4-301</b>	<b>PARKING VIOLATIONS.....</b>	<b>711</b>
4-301.1	OFFICER'S CONSIDERATIONS.....	712
4-301.2	PARKING CITATION INFORMATION.....	712
<b>[REDACTED SECTION]</b>		
4-303	<b>DRIVING WHILE INTOXICATED ARREST AND EQUIPMENT PROCEDURES.....</b>	<b>724</b>
4-303.1	<b>DWI ARREST-EVIDENTIARY CONSIDERATIONS.....</b>	<b>724</b>



Administrative and Operational Manual

September 12, 2022

---

<b>4-303.2</b>	<b>PRELIMINARY DWI ARREST PROCEDURES.....</b>	<b>724</b>
4-303.2.1	DEFINITIONS.....	724
<b>4-303.3</b>	<b>DWI DEFENDANTS INVOLVED IN FATAL CRASHES.....</b>	<b>724</b>
<b>4-303.4</b>	<b>BLOOD TEST.....</b>	<b>724</b>
4-303.5	FORMS TO BE COMPLETED.....	725
<b>4-303.6</b>	<b>APPEARANCE BEFORE A DISTRICT COURT COMMISSIONER.....</b>	<b>725</b>
<b>4-303.7</b>	<b>PHYSICAL SOBRIETY TESTS.....</b>	<b>725</b>
<b>4-303.8</b>	<b>COMPLETION OF DR-15 AND DR-15A FORMS.....</b>	<b>726</b>
<b>4-303.9</b>	<b>TIME LIMIT FOR ADMINISTERING TEST.....</b>	<b>727</b>
<b>4-303.10</b>	<b>MIRANDA WARNING AND QUESTIONING.....</b>	<b>727</b>
<b>4-303.11</b>	<b>ARRESTING OFFICER'S TEST PROCEDURES.....</b>	<b>727</b>
<b>4-303.12</b>	<b>INTOXIMETER OPERATOR TEST PROCEDURES.....</b>	<b>727</b>
4-303.13	DISTRIBUTION OF MSP FORM 33.....	728
<b>4-303.14</b>	<b>BLOOD TESTS.....</b>	<b>728</b>
<b>4-303.15</b>	<b>BLOOD ALCOHOL KIT CONTENTS.....</b>	<b>728</b>
<b>4-303.16</b>	<b>GENERAL BLOOD SAMPLE PROCEDURES.....</b>	<b>728</b>
<b>4-303.17</b>	<b>DR-15A PROCESSING AGREEMENT WITH MARYLAND TRANSPORTATION AUTHORITY (TOLL FACILITIES POLICE) WITH ATTACHMENT 1 AND 2.....</b>	<b>729</b>
<b>4-303.18</b>	<b>PROCESSING DRUG SUSPECTS.....</b>	<b>730</b>
<b>4-303.19</b>	<b>SUMMONSING OF WITNESSES.....</b>	<b>730</b>
<b>4-304</b>	<b>INTOXIMETER.....</b>	<b>730</b>
4-304.1	ROUTINE DUTIES OF INTOXIMETER OPERATOR.....	730
4-304.2	INTOXIMETER SUPERVISOR.....	730
4-304.3	CERTIFICATIONS OF INTOXIMETER.....	731
<b>4-305</b>	<b>RADAR.....</b>	<b>731</b>
4-305.1	RESPONSIBILITIES OF THE TRAFFIC OPERATIONS SUPERVISOR PERTAINING TO POLICE TRAFFIC RADAR AND SELECTIVE ENFORCEMENT.....	731
4-305.2	ISSUANCE AND CUSTODY OF RADAR UNITS.....	732
4-305.3	RESPONSIBILITIES AND GUIDELINES FOR THE RADAR OPERATOR.....	732
4-305.4	SPECIAL OPERATIONS USING POLICE TRAFFIC RADAR.....	733
<b>4-306</b>	<b>PROCEDURES FOR ORGAN DONORS.....</b>	<b>734</b>
<b>4-307</b>	<b>MOTOR VEHICLE SOBRIETY CHECK POINTS.....</b>	<b>735</b>
4-307.1	PROCEDURES.....	735
4-307.2	AFTER ACTION CRITIQUE.....	736
<b>4-309</b>	<b>TRAFFIC DIRECTION.....</b>	<b>736</b>
4-309.1	NOTIFICATIONS REGARDING ROAD CLOSURES.....	736
<b>4-310</b>	<b>EVENTS / INCIDENTS / AFTER ACTION REVIEW.....</b>	<b>738</b>
4-310.1	DEFINITIONS.....	738
4-310.2	EVENT PROCEDURE.....	739
4-310.3	INCIDENT PROCEDURE.....	739
4-310.4	EVENT / INCIDENT CONCLUSION.....	739
<b>4-400</b>	<b>VEHICLE CRASHES.....</b>	<b>740</b>
4-400.1	RESPONSIBILITIES OF RESPONDING OFFICER.....	740
4-400.2	REPORT REQUIREMENTS.....	741
4-400.3	ESTABLISHING INVESTIGATIVE RESPONSIBILITY.....	742
4-400.4	INVESTIGATOR'S RESPONSIBILITIES.....	742



Administrative and Operational Manual

September 12, 2022

---

4-400.5	SUPERVISOR'S RESPONSIBILITIES.....	743
4-400.6	HIT & RUN AND OTHER FOLLOW-UP INVESTIGATION.....	743
4-400.7	ALCOHOL RELATED FATAL OR LIFE THREATENING CRASHES.....	744
4-400.8	MECHANICAL DEFECTS.....	744
4-400.9	TRAFFIC OPERATIONS.....	744
4-400.10	TRAIN-VEHICLE-PEDESTRIAN CRASHES.....	745
<b>4-403</b>	<b>AIRCRAFT ACCIDENTS.....</b>	<b>746</b>
4-403.1	MILITARY AIRCRAFT.....	746
4-403.2	NON-MILITARY AIRCRAFT ACCIDENTS.....	746
<b>4-500</b>	<b>PROPERTY AND EVIDENCE MANAGEMENT.....</b>	<b>748</b>
4-500.1	DEFINITIONS.....	748
4-500.2	GENERAL PROPERTY PROCEDURES.....	748
4-500.3	KNOWN PROPERTY OWNERS – NOTIFICATION AND RELEASE.....	749
4-500.4	FOUND PROPERTY – NOTIFICATION AND RELEASE TO FINDERS.....	749
4-501	PROPERTY HELD CUSTODIAN.....	749
4-502	SECURE STORAGE AREAS.....	750
4-502.1	EVIDENCE LOCKERS.....	750
4-502.2	FORENSIC SCIENCE SECTION PROPERTY STORAGE.....	751
4-502.3	EXCEPTIONAL CIRCUMSTANCES.....	751
4-503	SEIZED PROPERTY.....	751
4-503.1	SEIZURE OF REGISTRATION PLATES AND DRIVERS' LICENSES (MVA).....	751
4-503.2	SEIZURE OF CURRENCY.....	751
4-503.3	CURRENCY SEIZED DURING DRUG AND/OR VICE INVESTIGATIONS.....	752
4-503.4	RECOVERED CURRENCY WITH UNKNOWN OWNER.....	752
4-503.5	COLLECTION AND DISPOSITION OF CURRENCY.....	752
4-503.6	STORAGE OF HIGH RISK ITEMS.....	752
4-503.7	SEIZED WEAPONS (OTHER THAN FIREARMS).....	753
4-503.8	SEIZURE OF FIREARMS.....	753
4-503.9	SEIZED FIREARMS NOT INVOLVING CRIMINAL CHARGES.....	753
4-503.10	FIREARMS RELEASE PROCEDURES AND ELIGIBILITY.....	753
4-503.11	FORFEITURE OF HANDGUNS.....	753
4-504	HANDLING OF FIREARMS SUBMITTED TO PROPERTY MANAGEMENT OR FORENSIC SCIENCE SECTION.....	755
4-504.1	FIREARMS ANALYSIS.....	755
4-504.2	NATIONAL INTEGRATED BALLISTIC INFORMATION NETWORK (NIBIN) PROGRAM.....	756
4-505	INSPECTION AND RELEASE OF PROPERTY.....	756
4-505.1	REVIEW AND INSPECTION OF PHYSICAL EVIDENCE.....	756
4-505.2	REVIEW AND INSPECTION OF SEXUALLY EXPLICIT OR CONTRABAND EVIDENCE.....	757
4-505.3	TRANSFER OF PROPERTY FOR COURT OR INVESTIGATIVE PURPOSES.....	758
4-505.4	RELEASE OF PROPERTY FOR TRAINING PURPOSES.....	758
4-506	PROPERTY DISPOSITION.....	758
4-506.1	DECEASED PERSONS - RELEASE OF PROPERTY TO NEXT OF KIN.....	759
4-506.2	DECEASED PERSONS - NO RELATIVES TO ACCEPT PERSONAL EFFECTS.....	759
4-506.3	PROTECTION OF DECEDENTS' PROPERTY.....	759
4-506.4	JUDICIAL SERVICES RESPONSIBILITY.....	760
4-506.5	REPORT DISTRIBUTION.....	761
4-507	CONVERSION OF CONFISCATED FIREARMS TO POLICE USE.....	761
4-508	PROPERTY INVENTORY AND AUDIT PROCEDURES.....	761
4-509	PROPERTY CLEARANCE PROCEDURES FOR EMPLOYEES.....	762
4-510	COLLECTION AND PRESERVATION OF EVIDENCE.....	762



Administrative and Operational Manual

September 12, 2022

4-511 LEGAL CONSIDERATIONS..... 762

4-512 FORENSIC SCIENCE SECTION ..... 762

4-513 PATROL OFFICER RESPONSIBILITIES ..... 763

4-514 BASIC CRIME SCENE GUIDELINES ..... 763

4-515 EVIDENCE COLLECTION ..... 764

**4-520 REQUESTS FOR FORENSIC EXAMINATION ..... 764**

4-521 PREPARING AND PACKAGING PROPERTY / EVIDENCE FOR SUBMISSION ..... 765

4-521.1 FSS EVIDENCE SUBMISSION PROCEDURES ..... 765

4-522 DRUG AND NARCOTICS EVIDENCE..... 766

4-523 PREPARATION OF NARCOTICS TO BE SENT TO MARYLAND STATE POLICE LABORATORY ..... 766

4-523.1 INSTRUCTIONS FOR THE MSP FORM #67A - CDS SUBMISSION..... 768

4-524 SUBMITTING NARCOTICS FOR WHICH ANALYSIS IS NOT NECESSARY ..... 768

4-527 DESTRUCTION OF NARCOTICS..... 769

4-527.1 INCINERATION OF DRUGS ..... 769

4-527.2 RECORDING NARCOTICS DESTRUCTION..... 769

4-528 MEDICATION COLLECTION PROGRAM ..... 769

4-530 DNA EVIDENCE ..... 770

**4-540 DIGITAL EVIDENCE..... 772**

4-540.1 DIGITAL EVIDENCE RECOVERY ..... 772

4-540.2 DIGITAL EVIDENCE SUBMISSION ..... 773

4-540.3 DIGITAL SURVEILLANCE VIDEO RECOVERY ..... 774

4-540.4 DIGITAL SURVEILLANCE VIDEO CLARIFICATION ..... 775

4-560 THERMO SCIENTIFIC TRUNARC ANALYZER DEFINITIONS ..... 775

4-560.1 THERMO SCIENTIFIC TRUNARC ANALYZER..... 775

4-560.2 OPERATOR RESPONSIBILITIES ..... 776

4-560.3 TRUNARC COORDINATOR RESPONSIBILITIES ..... 776

4-560.4 SAFETY PRECAUTIONS..... 776

4-560.5 SOLUTION KIT (TYPE H)..... 777

4-560.6 SCAN RESULT DEFINITIONS ..... 777

**4-600 ARRESTS ..... 779**

4-600.1 ARREST WARRANTS..... 779

4-600.2 WARRANTLESS ARRESTS ..... 779

4-600.3 VIOLATIONS OF PRETRIAL AND POSTTRIAL CONDITIONS OF RELEASE ..... 780

4-600.4 DETERMINING CONDITIONS OF RELEASE ..... 781

4-600.5 VIOLATIONS – CONDITIONS OF RELEASE ..... 781

4-601 ARRESTS BY COMMISSIONED SPECIAL POLICE OFFICER (SPO) ..... 782

4-601.1 ARREST OF AN ADULT..... 782

4-602 APPREHENSION OF ADULT BY OTHER THAN COMMISSIONED SPO ..... 782

4-603 ARREST OF FUGITIVE FROM ANOTHER JURISDICTION..... 783

4-603.1 FUGITIVE FROM JUSTICE - DISTRICT OF COLUMBIA (NO LOCAL CHARGES) ..... 783

4-604 ARREST OF ILLEGAL ALIENS ..... 784

4-605 ARREST OF FOREIGN NATIONALS ..... 784

4-605.1 DETENTION CENTER RESPONSIBILITIES ..... 785





Administrative and Operational Manual

September 12, 2022

---

[REDACTED]	[REDACTED]
[REDACTED]	[REDACTED]
[REDACTED]	[REDACTED]
[REDACTED]	[REDACTED]
[REDACTED]	[REDACTED]
[REDACTED]	[REDACTED]
[REDACTED]	[REDACTED]
[REDACTED]	[REDACTED]
[REDACTED]	[REDACTED]
[REDACTED]	[REDACTED]
[REDACTED]	[REDACTED]
[REDACTED]	[REDACTED]
[REDACTED]	[REDACTED]
[REDACTED]	[REDACTED]
[REDACTED]	[REDACTED]
[REDACTED]	[REDACTED]
[REDACTED]	[REDACTED]
[REDACTED]	[REDACTED]

**4-607 EXEMPTIONS TO ARREST ..... 791**

    4-607.1 RELEASE OF PERSONS FROM ARREST ..... 791

    4-607.2 CRIMINAL DEBRIEFING REPORT ..... 792

**4-608 USE OF RESTRAINING DEVICES - GENERALLY ..... 793**

    4-608.1 USE OF EXPECTORANT SHIELDS ..... 793

[REDACTED]

[REDACTED]

[REDACTED]

[REDACTED]

[REDACTED]

[REDACTED]

[REDACTED]

[REDACTED]

[REDACTED]

[REDACTED]

[REDACTED]

[REDACTED]

[REDACTED]

[REDACTED]

[REDACTED]

[REDACTED]

[REDACTED]

[REDACTED]

[REDACTED]

[REDACTED]

[REDACTED]

[REDACTED]

[REDACTED]

[REDACTED]

[REDACTED]

[REDACTED]

[REDACTED]

[REDACTED]

**4-611 SEARCH OF ARRESTEES – SWORN ..... 804**

**4.611.1 DEFINITIONS ..... 804**

**4.611.2 SEARCHES – GENERAL PROCEDURE ..... 804**

**4-611.3 SEARCHES BY GENDER ..... 804**

**4-611.4 SEXUALLY INVASIVE SEARCHES ..... 805**

**4-611.5 SEARCH OF THE MOUTH ..... 806**

**4-611.6 REPORTING REQUIREMENTS ..... 807**

    4-612 REMOVAL OF PROPERTY ITEMS FROM PRISONERS ..... 807

    4-612.1 RELEASE OF PROPERTY TO PERSON OTHER THAN PRISONER ..... 807

    4-613 BOOKING PROCEDURES - OBTAINING ID NUMBERS ..... 807

    4-613.1 REFUSAL (OR INABILITY) TO PROVIDE INFORMATION FOR BOOKING PROCEDURES ..... 808

    4-613.2 JOHN / JANE DOE ARRESTS ..... 808

    4-613.3 ARRESTEE’S AGE NOT DETERMINED ..... 808

    4-613.4 PRISONERS REFUSING TO BE FINGERPRINTED OR PHOTOGRAPHED ..... 808



Administrative and Operational Manual

September 12, 2022

---

4-613.5	STATEMENT OF CHARGES - ARREST BOOKING SYSTEM.....	808
4-613.6	PROCESSING ADULTS .....	808
4-614	CRIMINAL SUMMONS SERVICE .....	810
4-614.1	CRIMINAL SUMMONS PROCEDURE.....	810
4-614.2	SERVING CRIMINAL SUMMONS .....	811
<b>4-615</b>	<b>COURT ORDERED FINGERPRINTING .....</b>	<b>812</b>
<b>4-616</b>	<b>INTERVIEWS AND INTERROGATIONS .....</b>	<b>813</b>
4-616.1	INTERROGATION OF SUSPECT AND/OR PRISONER.....	813
4-616.2	FIELD INTERVIEWS.....	813
4-617	MARYLAND COURT RULE 4-212 PRESENTMENT BEFORE A JUDICIAL OFFICER.....	814
<b>4-618</b>	<b>PRISONER ESCAPES.....</b>	<b>815</b>
4-619	NOTICE OF SECURITY RISK .....	816
4-619.1	DISTRIBUTION .....	816
4-619.2	NOTICE FORM .....	816
4-619.3	SUMMARY.....	816
4-619.4	EVENT NUMBER AND RECORDS .....	817
<b>4-620</b>	<b>JUVENILE PROCEDURES .....</b>	<b>818</b>
4-620.1	DEFINITIONS.....	818
4-620.2	TAKING JUVENILES INTO CUSTODY .....	819
4-620.3	NOTIFICATION OF CUSTODY.....	819
4-620.4	REPORTABLE OFFENSES .....	819
4-620.5	ARRESTING OFFICER'S RESPONSIBILITIES.....	821
4-620.6	SUPERVISORS' RESPONSIBILITIES.....	821
4-620.7	RESPONSIBILITIES OF SCHOOL RESOURCES UNITS .....	821
4-620.8	RELEASE OF JUVENILES.....	822
4-621	CRIMES INVOLVING JUVENILES (NO PHYSICAL ARREST).....	822
4-621.1	IDENTITY OF JUVENILE .....	823
4-622	GUIDE TO CHARGING THE JUVENILE OFFENDER (MATRIX) .....	824
<b>4-623</b>	<b>PROCESSING JUVENILES.....</b>	<b>826</b>
4-623.1	CHARGED AS ADULTS .....	826
4-623.2	CHARGED AS JUVENILES.....	826
4-624	DISPOSITION OF CHARGES BY THE DEPARTMENT OF JUVENILE SERVICES.....	826
4-625	TEMPORARY DETENTION OF JUVENILES .....	827
4-625.1	CUSTODY PROCEDURES .....	827
4-625.2	REPORTING .....	828
4-625.3	INTERVIEW AND INTERROGATION OF JUVENILES .....	828
<b>4-626</b>	<b>JUVENILE DRIVER PARENT NOTIFICATIONS .....</b>	<b>830</b>
4-626.1	OFFICER'S RESPONSIBILITIES.....	830
<b>4-627</b>	<b>REQUESTS FOR ASSISTANCE FROM BAIL BONDSMEN AND BOUNTY HUNTERS - GENERALLY.....</b>	<b>831</b>
4-627.1	PROVIDING ASSISTANCE - OFFICERS .....	831
<b>4-650</b>	<b>MARYLAND UNIFORM CIVIL CITATIONS .....</b>	<b>832</b>
4-650.1	GENERAL INFORMATION.....	832
4-650.2	REFUSAL TO PROVIDE IDENTIFICATION.....	832
4-650.3	UNIFORM MUNICIPAL INFRACTION / CIVIL CITATION (#DC-28).....	832





Administrative and Operational Manual

September 12, 2022

4-650.4 POSSESSION OF MARIJUANA – CIVIL OFFENSE..... 833

4-650.5 UNIFORM JUVENILE CIVIL CITATION FOR ALCOHOL OFFENSES FORM #DC-31..... 836

**4-651 MARYLAND UNIFORM CRIMINAL CITATION FORM #DC/CR-45 ..... 837**

**4-651.1 CRITERIA FOR ISSUING CITATION ..... 838**

**4-651.2 OFFENSES REQUIRING CITATIONS ..... 838**

**4-651.4 EXCEPTIONS - OFFENSES THAT CANNOT BE CHARGED BY CITATION..... 839**

**4-651.5 REQUIRED FORMS AND REPORTS ..... 839**

4-651.6 ADDITIONAL CRIMINAL CHARGES..... 840

**4-651.7 LAW ENFORCEMENT REPORTING - STATISTICAL DATA COLLECTION ..... 841**

**4-660 PROCESSING AND TEMPORARY DETENTION AREAS..... 844**

**4-660.1 TRAINING OF PERSONNEL ..... 845**

**4-660.2 WEAPONS CONTROL ..... 845**

**4-660.3 OBSERVATION AND CONTROL OF DETAINED PERSONS..... 845**

**4-660.4 SEARCH OF PERSONS TO BE PLACED IN TEMPORARY DETENTION AREAS..... 845**

**4-660.5 REQUESTING ASSISTANCE IN TEMPORARY DETENTION AREA..... 846**

**4-660.6 ADMINISTRATIVE REVIEW ..... 846**

**4-670 SEARCH AND SEIZURE ..... 847**

4-670.1 SEARCH AND SEIZURE WITHOUT A WARRANT ..... 847

4-670.2 SEARCH INCIDENT TO ARREST..... 847

4-670.3 CONSENT SEARCHES ..... 847

4-670.4 STOP AND FRISK ..... 847

4-670.5 VEHICLE SEARCHES..... 848

4-670.6 CRIME SCENE SEARCHES ..... 848

4-672 SEARCH AND SEIZURE - SEARCH WARRANTS..... 848

4-672.1 SEARCH WARRANTS..... 849

4-672.2 SEARCH WARRANT APPLICATION / SERVICE PROCEDURES..... 849

**4-680 VICTIM/ WITNESS ASSISTANCE ..... 851**

4-680.1 RIGHTS OF VICTIMS AND WITNESSES..... 851

4-680.2 VICTIM/ WITNESS ASSISTANCE DURING PRELIMINARY INVESTIGATIONS..... 852

4-680.3 VICTIM / WITNESS ASSISTANCE DURING FOLLOW-UP INVESTIGATIONS ..... 852

4-680.4 VICTIM SERVICES COORDINATOR..... 853

4-680.5 REQUESTS FOR CERTIFICATIONS OF VICTIM HELPFULNESS..... 853

4-690 HANDLE WITH CARE PROGRAM ..... 853

4-690.1 PURPOSE AND SCOPE ..... 853

4-690.2 LAW ENFORCEMENT RESPONSIBILITIES..... 854

4-690.3 PROTOCOLS AND CONFIDENTIALITY ..... 854

**4-700 CRIMINAL INVESTIGATION ..... 856**

4-700.1 CRIMINAL INVESTIGATIONS DIVISION - GENERAL RESPONSIBILITIES..... 856

4-700.2 REPORT WRITING ..... 856

4-700.3 AUTO THEFT INVESTIGATIONS - IDENTIFYING STOLEN VEHICLES..... 856





Administrative and Operational Manual

September 12, 2022

**4-702 SEX CRIMES .....860**

4-702.1 INITIAL RESPONSE .....860

4-702.2 CRIMINAL INVESTIGATIONS' RESPONSIBILITIES .....860

4-702.3 VICTIM INTERVIEWS.....861

4-702.3.5 VICTIM OF SEXUAL ASSAULT – WAIVER OF RIGHTS – PROHIBITED .....861

4-702.3.6 VICTIM OF SEXUAL ASSAULT – REQUEST TO SUSPEND INVESTIGATION.....862

4-702.3.7 VICTIM OF SEXUAL ASSAULT – CONFIDENTIALITY PROTECTIONS.....862

4-702.4 SEXUAL ASSAULT NURSE EXAMINER PROGRAM .....862

4-702.5 CALL OUT OF SANE NURSES.....862

4-702.6 VICTIM SUPPORT.....863

4-702.7 EVIDENCE AND REPORTS.....863

4-702.8 SEX OFFENDER REGISTRY PROGRAM .....863

4-702.9 SEX OFFENDER ADDRESS VERIFICATION .....864

**SEX OFFENSES - ANNOTATED CODE OF MARYLAND, CRIMINAL LAW (QUICK REFERENCE) .....864**

**4-703 CRIMES IN THE COUNTY DETENTION CENTER.....866**

4-703.1 MAJOR CRIMES .....866

4-703.2 MINOR CRIMES .....866

4-703.3 SECURITY OF VICTIM / INMATE .....866

**4-704 CHILD NEGLECT CASES .....867**

4-704.1 RESPONSIBILITY TO INVESTIGATE .....867

4-704.2 EXAMPLES OF CHILD NEGLECT .....867

4-704.3 MARYLAND SAFE HAVEN PROGRAM .....867

4-704.4 EMPLOYEE RESPONSIBILITIES.....868

**4-705 CHILD ABUSE CASES .....869**

4-705.1 RESPONSIBILITY TO INVESTIGATE .....869

4-705.2 AUTHORITY FOR TAKING A CHILD INTO CUSTODY.....869

4-705.3 ASSISTING PROTECTIVE SERVICES WITH CHILD REMOVAL.....869

4-706 EYEWITNESS EVIDENCE .....870

4-706.1 DEFINITIONS.....870

4-706.2 INITIAL REPORT OF A CRIME – CALL TAKER AND FIRST RESPONDER RESPONSIBILITIES .....870

4-706.3 CONDUCTING SHOW-UPS (EFFECTIVE 3/29/19) .....871

4-706.4 DOCUMENTATION OF SHOW-UPS (EFFECTIVE 3/29/19).....871

4-706.5 PHOTO ARRAYS .....871

4-706.6 COMPOSING A PHOTOGRAPHIC ARRAY .....872

4-706.7 PRESENTATION AND DOCUMENTATION OF PHOTO ARRAYS.....872

4-706.8 RETAINING PHOTO ARRAY AS EVIDENCE.....873

4-706.9 CID RESPONSIBILITIES.....873

4-706.10 DEVELOPING AND USING COMPOSITE IMAGES .....873

4-706.11 DOCUMENTING EYEWITNESS EVIDENCE.....874

**4-707 ASSET SEIZURE AND FORFEITURE PROCEDURES.....875**

4-707.1 FORFEITURE OF CDS MONIES.....875

4-707.2 FORFEITURE OF GAMBLING MONIES .....875

4-707.3 VEHICLES - NARCOTIC RELATED IMPOUNDS .....876

4-707.4 HANDGUNS .....877

4-707.5 CONVERSION OF CONFISCATED HANDGUNS TO POLICE USE.....877

**4-708 DEATH INVESTIGATION / NOTIFICATIONS AND RESPONSIBILITIES.....877**



Administrative and Operational Manual

September 12, 2022

---

4-708.1	NOTIFICATION OF MEDICAL EXAMINER .....	877
4-708.2	FORENSIC INVESTIGATOR / DEPUTY MEDICAL EXAMINER .....	878
4-708.3	NOTIFICATION OF CRIMINAL INVESTIGATIONS DIVISION .....	878
4-708.4	MEDICAL ORDERS FOR LIFE SUSTAINING TREATMENT (MOLST) .....	879
4-708.5	DEATHS AT NURSING HOMES/LONG TERM CARE FACILITIES .....	879
4-708.6	STATE ANATOMY BOARD .....	879
<b>4-709</b>	<b>TRUTH VERIFICATION FUNCTION .....</b>	<b>879</b>
4-709.1	PURPOSE OF EXAMINATION.....	880
4-709.2	PROCEDURES FOR REQUESTING POLYGRAPH EXAMINATIONS.....	881
4-709.3	SUITABILITY FOR EXAMINATION .....	881
4-709.4	REQUESTING OFFICER’S RESPONSIBILITIES .....	882
4-709.5	EXAMINER’S RESPONSIBILITIES.....	883
<b>4-710</b>	<b>NOTIFICATION OF SERIOUS INCIDENTS OR UNUSUAL OCCURRENCES.....</b>	<b>884</b>
<b>4-711</b>	<b>CANINE (K-9) OPERATIONS.....</b>	<b>884</b>
4-711.1	DEFINITIONS.....	884
4-711.2	OPERATIONAL PROCEDURES.....	885
4-711.3	K-9 PATROL DUTIES .....	886
4-711.4	SPECIAL ASSIGNMENTS .....	886
4-711.5	ON-CALL RESPONSIBILITIES.....	886
4-711.6	PROCEDURES FOR AGENCY PERSONNEL ASSOCIATED WITH K-9 OPERATIONS.....	886
4-711.7	ARREST/APPREHENSION PROCEDURES .....	887
4-711.8	REQUESTS FROM OUTSIDE AGENCIES FOR K-9 ASSISTANCE .....	887
4-711.9	USE OF ANCILLARY K-9 SUPPORT FROM NON-POLICE SOURCES .....	888
4-711.10	RETIREMENT AND ADOPTION OF K-9 DOGS.....	888
<b>4-712</b>	<b>HONOR GUARD.....</b>	<b>888</b>
4-712.1	DEFINITIONS.....	888
4-712.2	EQUIPMENT .....	890
4-712.3	UNIFORMS .....	890
4-712.4	SELECTION.....	890
4-712.5	HONOR GUARD COMMANDER.....	891
4-712.6	HONOR GUARD COORDINATOR.....	891
4-712.7	HONOR GUARD TRAINING .....	891
4-712.8	REQUESTS FOR PERFORMANCE .....	891
<b>4-714</b>	<b>MEDICAL CANNABIS (MARIJUANA).....</b>	<b>892</b>
4-714.1	CCSO EMPLOYEES AS PATIENTS OR CAREGIVERS.....	892
4-714.2	CONTACT WITH REGISTERED MEDICAL CANNABIS PATIENTS .....	893
4-714.3	DETERMINING VALID REGISTRATION.....	893
4-714.5	<b>VIOLETATIONS OF MMCC COMAR REGULATIONS.....</b>	<b>894</b>
4-714.6	SEIZURE OF MEDICAL MARIJUANA .....	894
4-714.7	FIREARMS .....	895
<b>4-715</b>	<b>BURGLARY.....</b>	<b>896</b>
4-715.1	PATROL OFFICERS’ RESPONSIBILITIES .....	896
4-715.2	CRIMINAL INVESTIGATIONS’ RESPONSIBILITIES .....	897
4-715.3	SUPERVISOR’S RESPONSIBILITIES.....	897



Administrative and Operational Manual

September 12, 2022

**4-716 CIVIL CHILD CUSTODY ORDERS.....900**

**4-717 KIDNAPPING .....900**

4-717.1 “KIDNAPPING” UNDER § 3-502 OF THE CRIMINAL LAW ARTICLE ..... 901

4-717.2 “CHILD KIDNAPPING” UNDER § 3-503 OF THE CRIMINAL LAW ARTICLE ..... 901

4-717.3 KIDNAPPING BY A RELATIVE ..... 901

**4-810 SECURITY RESPONSE VESSEL (SRV).....901**

4-810.1 SRV DEPLOYMENT ..... 902

**4-900 AUTOMATED EXTERNAL DEFIBRILLATORS.....904**

4-900.1 DEFINITIONS..... 904

4-900.2 PURPOSE ..... 904

4-900.3 CARE AND MAINTENANCE ..... 904

4-900.4 DEPLOYMENT PROTOCOL ..... 905

4-900.5 REPORTING PROCEDURES..... 905

4-900.6 REPORT DISTRIBUTION..... 906

4-900.7 TRAINING ..... 906

4-900.8 DOWNLOADING AED DATA ..... 906

4-900.9 REQUIRED EQUIPMENT ..... 906

4-900.10 QUALITY ASSURANCE ..... 907

**CHAPTER 5 – AGENCY REPORTING SYSTEM .....908**

5-100 REPORTS AND REPORT WRITING..... 908

5-100.1 GENERAL REPORTING PROCEDURES ..... 908

5-100.2 CIRCUMSTANCES NOT REQUIRING REPORTS ..... 909

5-100.3 INCIDENTS REQUIRING REPORTS ..... 909

5-100.4 CIRCUMSTANCES REQUIRING SPECIFIC REPORTING PROCEDURES..... 910

5-100.5 REPORTING CAUTIONS..... 910

5-100.6 TELEPHONE / LETTER GENERATED REPORTS..... 911

5-100.7 LEGIBLE NAMES..... 912

**5-110 TELEPHONE REPORTING .....912**

5-110.1 ORGANIZATIONAL POSITIONING..... 912

5-110.2 CASE CRITERIA..... 912

5-110.3 REPORT REVIEW ..... 913

5-110.4 FOLLOW-UP INVESTIGATION ..... 913

5-110.5 PROVIDING REPORT TO COMPLAINANT..... 913

5-110.6 SPECIAL PROVISIONS..... 913

**5-150 ADMINISTRATIVE REPORTING PROGRAM .....913**

5-151 AGENCY ANNUAL REPORT ..... 914

5-152 ANALYSIS OF AGENCY USE OF FORCE ..... 915

5-153 GOALS AND OBJECTIVES..... 915

5-154 ANALYSIS OF CRIME DATA ..... 915

5-155 ANNUAL JUDGEMENT OR SETTLEMENT REPORT ..... 916

5-156 REVIEW OF SPECIALIZED ASSIGNMENTS ..... 916

5-157 BUDGET RECOMMENDATIONS ..... 917

5-158 FISCAL MANAGEMENT STATUS REPORT..... 917

5-159 ANALYSIS OF EMPLOYEE GRIEVANCES ..... 917

5-160 EMPLOYEE PERFORMANCE EVALUATION ..... 917



Administrative and Operational Manual

September 12, 2022

---

5-161	ENTRY LEVEL EMPLOYEE PERFORMANCE EVALUATION.....	917
5-162	PURSUIT REPORTS AND ANALYSIS.....	918
5-163	REVIEW AND EVALUATION OF JUVENILE PROGRAMS.....	918
5-164	EVALUATION OF CRIME PREVENTION EFFECTIVENESS .....	918
5-165	COMMUNITY INVOLVEMENT .....	919
5-166	CITIZENS ATTITUDES AND OPINIONS SURVEY .....	919
5-167	HOSTAGE / BARRICADE AFTER ACTION REPORT.....	919
5-168	AFTER ACTION SPECIAL EVENT REPORT.....	920
5-169	STATISTICAL SUMMARY OF INTERNAL INVESTIGATIONS .....	920
5-170	STAFF INSPECTION OF ORGANIZATIONAL COMPONENTS.....	920
5-171	BIAS BASED PROFILING REVIEW .....	921
5-172	REVIEW OF VICTIM / WITNESS ASSISTANCE NEEDS AND AVAILABLE SERVICES.....	921
5-173	REVIEW OF NEED FOR CROSSING GUARD.....	922
5-174	REPORT OF ESCAPED PRISONER.....	922
5-175	INSPECTIONS OF TEMPORARY HOLDING AREAS .....	923
5-177	THREAT TO HOLDING FACILITY REPORT .....	923
5-178	COURT SECURITY SURVEY.....	923
5-179	INSPECTION / TEST OF COMMUNICATIONS CENTER ALTERNATE POWER SOURCE .....	923
5-180	AUDIT OF CENTRAL RECORDS COMPUTER SYSTEM.....	924
5-181	REPORT OF CRIME SCENE PROCESSING.....	924
5-182	PROPERTY REPORTS AND INSPECTION PROCEDURES .....	924
5-183	SELECTIVE ENFORCEMENT REPORT.....	925
5-185	EST REPORT .....	925
<b>5-195</b>	<b>LIST OF ADMINISTRATIVE REPORTS.....</b>	<b>927</b>
5-200	AGENCY FORMS.....	929
5-200.1	FORMS CONTROL.....	929
5-200.2	FORMS RESPONSIBILITY .....	930
5-200.4	FORMS DEVELOPMENT .....	930
5-200.5	INTRANET FORMS .....	931
5-300	AGENCY CORRESPONDENCE .....	932
5-300.2	STATIONERY FORMAT .....	932
5-301	MAILING INSTRUCTIONS.....	932
5-302	MECHANICS OF BUSINESS LETTERS.....	932
5-303	ADDRESS OF PERSONS HOLDING HONORARY OR OFFICIAL POSITIONS .....	933
5-304	TRANSMITTAL OF INTRA-AGENCY CORRESPONDENCE .....	933
5-305	RECEIPT AND DISSEMINATION OF INFORMATION .....	934
	EXAMPLES .....	935
	CHAPTER 6 – RISK MANAGEMENT, SAFETY, AND FITNESS.....	937
6-100	PURPOSE .....	937
6-101	EMPLOYEE RESPONSIBILITIES.....	937
6-102	SUPERVISORS’ RESPONSIBILITIES.....	938
6-103	SAFETY AND INSPECTIONS OFFICER .....	938
6-104	SAFETY INSPECTIONS.....	940
6-104.1	SAFETY SUGGESTIONS.....	940
<b>6-200</b>	<b>SAFE WORK PRACTICES.....</b>	<b>940</b>
6-201	EMPLOYEE FITNESS PROGRAM .....	941
6-201.1	FITNESS COORDINATOR.....	942
6-201.3	FITNESS TESTING PROGRAM .....	942
6-201.4	FITNESS INCENTIVES.....	942



Administrative and Operational Manual

September 12, 2022

---

6-201.5	PERSONAL TRAINING PROGRAM.....	944
6-201.6	NEWLY HIRED POLICE AND CORRECTIONAL OFFICERS.....	944
6-202	PROCEDURES IN CASE OF ACCIDENT OR INJURY .....	944
6-202.1	VOLUNTEER INJURIES.....	944
6-202.2	INJURY INVESTIGATIONS .....	945
6-202.3	OFFICERS INVOLVED IN CRITICAL INCIDENTS.....	945
6-202.4	NOTIFICATION OF INJURY .....	945
6-203	USE OF INTOXICANTS AND DRUGS .....	945
6-203.1	EMPLOYEE DRUG TESTING.....	946
6-203.2	DEFINITIONS.....	946
6-203.3	RANDOM DRUG TESTING.....	946
6-203.4	ADMINISTRATION .....	947
6-203.5	PERSONNEL SUBJECT TO TESTING.....	947
6-203.6	NOTIFICATIONS.....	947
6-203.7	TEST DEFERRALS.....	948
6-203.8	TESTING PROCESS .....	948
6-203.9	POSITIVE TEST RESULT.....	948
6-203.10	NEGATIVE TEST RESULT.....	949
<b>6-204</b>	<b>INGESTION OR EXPOSURE TO CDS .....</b>	<b>949</b>
6-204.1	USE OF CDS DURING COVERT INVESTIGATIONS.....	949
6-204.2	ACCIDENTAL EXPOSURE TO CDS.....	949
<b>6-300</b>	<b>BUILDING EMERGENCY EVACUATION.....</b>	<b>950</b>
6-300.1	EVACUATION PROCEDURES .....	950
6-300.2	EVACUATION OF PERSONNEL.....	951
6-301	FIRE PREVENTION AND EXTINGUISHERS .....	952
6-301.1	FIRE CLASSIFICATION AND EQUIPMENT.....	952
6-301.2	PORTABLE FIRE EXTINGUISHERS .....	953
6-301.3	INSPECTION AND MAINTENANCE OF EQUIPMENT .....	953
6-301.4	TRAINING .....	953
6-301.5	FIRE ALARM AND EMERGENCY PROCEDURE.....	954
6-301.6	FIRE PREVENTION HOUSEKEEPING .....	954
6-301.7	EMERGENCY EXITS .....	954
6-301.8	APPLIANCES .....	954
6-301.9	FLAMMABLE LIQUID STORAGE AND HANDLING .....	955
6-310	HAZARDOUS / RADIOACTIVE MATERIALS AND WEAPONS OF MASS DESTRUCTION (WMD).....	955
6-310.1	DEFINITIONS.....	955
6-310.2	OFFICER RESPONSIBILITIES.....	956
6-310.3	NOTIFICATIONS.....	956
6-310.4	HAZARDOUS MATERIALS GUIDEBOOK.....	957
6-315	CHEMICALS / HAZARDOUS MATERIALS IN THE WORKPLACE .....	957
6-315.1	HAZARD COMMUNICATION STANDARDS .....	957
6-315.2	POLICY AND PROCEDURES .....	957
6-315.3	MSDS / CHEMICAL LIST COMPILATION RESPONSIBILITY .....	958
6-315.4	LABELS AND OTHER FORMS OF WARNING.....	959
6-315.5	EMPLOYEE INFORMATION AND RIGHT TO KNOW.....	959
6-315.6	MARYLAND OCCUPATIONAL SAFETY AND HEALTH (MOSH) REGULATIONS .....	959
6-315.7	TRAINING .....	959
6-320	COMMUNICABLE DISEASES / BLOOD BORNE PATHOGENS .....	960
6-320.1	DEFINITIONS.....	960



Administrative and Operational Manual

September 12, 2022

6-320.2	HIV INFECTION .....	962
6-320.3	HBV INFECTION .....	962
6-320.4	SMALLPOX INFECTION .....	962
6-320.5	GENERAL PROGRAM MANAGEMENT.....	962
6-320.5.1	TRAINING DIVISION RESPONSIBILITIES.....	962
6-320.5.2	DIVISION COMMANDERS / DIRECTORS AND SUPERVISORS .....	963
6-320.5.3	EMPLOYEES .....	963
6-320.5.4	QUARTERMASTER .....	963
6-320.5.5	AVAILABILITY OF THE EXPOSURE CONTROL PLAN PACKET TO EMPLOYEES.....	963
6-320.7	TRAINING AND EDUCATION .....	964
6-320.8	PERSONAL PROTECTIVE EQUIPMENT.....	965
6-320.9	EQUIPMENT ISSUE AND REPLACEMENT.....	966
6-320.10	STANDARDS FOR WEARING PROTECTIVE EQUIPMENT .....	967
6-320.11	IMMUNIZATIONS - GENERALLY .....	968
6-320.12	<b>BIOHAZARD CONTAINERS, LABELS AND SIGNS .....</b>	969
6-320.13	<b>DISPOSAL OF CONTAMINATED WASTE.....</b>	970
6-320.14	POST EXPOSURE EVALUATION AND FOLLOW-UP.....	970
6-320.15	RECORDS MAINTENANCE.....	971
6-350	<b>ANIMAL BITE CASES - RABIES EXPOSURE .....</b>	972
6-350.1	<b>CUSTODY OF ANIMAL.....</b>	973
6-350.2	<b>PERSONS APPREHENDED / ARRESTED WITH ANIMALS.....</b>	973
6-350.2.1	<b>LIVE, INJURED OR DEAD DOMESTIC ANIMALS INVOLVED IN MOTOR VEHICLE CRASHES .....</b>	973
6-350.3	<b>DEAD ANIMALS - NOTIFICATION .....</b>	973
	[REDACTED]	
	[REDACTED]	
	[REDACTED]	
	[REDACTED]	
	[REDACTED]	
	[REDACTED]	
	[REDACTED]	
	[REDACTED]	
	[REDACTED]	
	[REDACTED]	
	[REDACTED]	
	[REDACTED]	
	[REDACTED]	
	[REDACTED]	
	[REDACTED]	
	[REDACTED]	
	[REDACTED]	
6-500	BUILDING, OFFICE AND CLERICAL SAFE WORKING PRACTICES.....	981
6-501	GENERAL RULES FOR SAFETY.....	981
6-502	HOUSEKEEPING .....	981
6-502.1	SAFE HOUSEKEEPING PRACTICES .....	982
6-502.2	OFFICE MACHINES.....	982
6-502.3	DESKS AND TABLES.....	982
6-502.4	CHAIRS .....	982
6-502.5	FANS.....	983
6-502.6	FILE CABINETS .....	983
6-502.7	DOORS AND WINDOWS .....	983
6-520	PROTECTIVE EQUIPMENT AND SAFE WORKING PRACTICES.....	983
6-520.1	SAFETY PRACTICES .....	983
6-520.3	PERSONAL CLOTHING AND ACCESSORIES WHILE ON DUTY .....	984
6-520.3	PROTECTIVE CLOTHING.....	984



Administrative and Operational Manual

September 12, 2022

---

6-520.4	HEAD PROTECTION .....	984
6-520.5	FOOT PROTECTION.....	985
6-520.6	EYE PROTECTION.....	985
6-520.7	RESPIRATORY PROTECTION.....	985
6-520.8	HAND PROTECTION.....	986
6-520.9	HEARING PROTECTION.....	986
6-520.10	WORKING AROUND MACHINES .....	987
6-520.11	LADDERS.....	987
6-525	LIFTING AND CARRYING TECHNIQUES.....	987
6-525.1	PULLING AND PRYING .....	988
6-530	COLD WEATHER AND HEAT MANAGEMENT.....	988
6-530.1	COLD WEATHER GUIDELINES .....	988
6-530.2	HEAT STRESS MANAGEMENT.....	990
<b>6-540</b>	<b>SAFETY PRECAUTIONS FOR DOWN ELECTRIC LINES .....</b>	<b>991</b>
6-540.1	PROCEDURES.....	991
<b>6-600</b>	<b>AGENCY VEHICLE CRASHES.....</b>	<b>991</b>
6-600.1	NOTIFICATION OF INVOLVEMENT.....	992
6-600.2	GENERAL RESPONSIBILITIES.....	992
6-600.3	CONDUCT OF INVESTIGATION.....	993
6-601	DOCUMENTING DAMAGE TO AGENCY VEHICLES.....	994
6-602	DISPOSITION OF INOPERABLE AGENCY VEHICLES .....	994
6-605	VEHICLE EQUIPMENT .....	994
6-607	AGENCY VEHICLE REPAIRS.....	994
6-608	OPR INVESTIGATION .....	995
6-608.1	DETERMINATION OF PREVENTABILITY.....	995
6-608.2	PREVENTABLE COLLISION FACTORS .....	995
6-610	AGENCY COLLISION COMMITTEE .....	997
6-610.1	COMMITTEE PROCEDURES.....	998
6-610.2	WORK SHEET INSTRUCTIONS .....	998
6-610.3	DISPOSITION OF AGENCY COLLISIONS.....	999
6-611	QUARTERLY AGENCY COLLISION REPORT.....	1001
6-612	AGENCY COLLISION FREE DRIVING AWARDS.....	1001
6-612.1	ARRIVE ALIVE PROJECT.....	1002
6-700	WORK SITE SAFETY INSPECTIONS.....	1002
6-701	TYPES OF INSPECTIONS .....	1003
6-702	SAFETY INSPECTION GUIDELINES .....	1003
6-703	INSPECTION RECORDS.....	1004
6-704	NOTICE OF SAFETY VIOLATIONS.....	1004
6-705	JOB SAFETY ANALYSIS FOR HAZARDOUS WORK .....	1005
6-706	JOB SAFETY TRAINING .....	1005
<b>SO/14-2</b>	<b>RULES AND REGULATIONS, ORDERS, ETC.....</b>	<b>1006</b>
<hr/>		
<b>SO/21-3</b>	<b>D.S.S. NOTIFICATIONS .....</b>	<b>1018</b>
<b>SO/22-1</b>	<b>JUVENILE JUSTICE REFORM ACT .....</b>	<b>1019</b>





Administrative and Operational Manual

September 12, 2022

---

**THIS PAGE  
INTENTIONALLY  
LEFT BLANK**



**Administrative and Operational Manual**

**September 12, 2022**

**0-000 AOM INTRODUCTION**

**0-001 MANUAL OVERVIEW**

This document is hereby established as the Administrative and Operational Manual of the Charles County Sheriff's Office, hereafter referred to as the "Manual" or the "AOM." The rules, policies, and procedures contained herein are binding upon all persons who work under the authority of the Sheriff of Charles County, Maryland.

This document is intended to address the responsibilities and conduct of employees in the performance of their duties as employees of the Sheriff's Office, both on- and off-duty. It is recognized that no policy document can anticipate all possible circumstances an employee may encounter.

It is also recognized that employees may be required to, in the face of exigent circumstances, act in a manner which may immediately seem inconsistent with, or not covered by, the policies within the Manual. When such actions arise, the employee must assume the responsibility for any action taken which is contrary to, or not covered by, this Manual. However, any supervisory, management, or administrative review of the employee's actions will be completed in the light of the facts known to the employee at the time of such action.

Concurrently, employees who take actions clearly inappropriate, or failing actions clearly required in the instant case, will be properly held accountable. This stance is designed to allow for as much latitude of action in unanticipated circumstances as is needed, while at the same time holding employees responsible for their actions and judgment.

**0-001.1 NATURE OF THE MANUAL**

This Manual is an administrative document. Its dictates require conformance by those persons who are subject to the authority of the Manual. The Manual does not create or modify law. Violations of the rules, policies, and procedures set forth in the Manual may expose persons who are subject to its authority, to administrative sanctions. The Manual is not, however, intended to create a greater civil or criminal liability than would otherwise be available under law. Finally, the Manual is not, and should not be construed to be, a contract.

**0-001.2 TERM OF THE MANUAL**

The Manual will be labeled according to the date it is published. All material contained in the Manual is valid until replaced, changed, or rescinded in writing. The Manual remains in effect through changes in the administration of the Office of the Sheriff, unless it is specifically revoked in writing by the Sheriff.

**0-001.3 ORDER OF PRECEDENCE AND SAVING CLAUSE**

This Manual is superior to any and all other documents within the Office of the Sheriff, Charles County, Maryland. Any portion of other documents, which is in conflict with the Manual, is void. Other documents, or portions of documents, containing rules, policies, or procedures which are not in conflict with the Manual, remain in force until replaced or rescinded.

If any part of this Manual is found to be in conflict with any law of Maryland or of the United States, or decision of any Court of competent jurisdiction, that part of the Manual so in conflict, is null and void. However, all other parts of the Manual shall remain in full force. In the event of any conflict between any sections of the Manual, the most recently dated section shall control.

**0-001.4 KNOWLEDGE REQUIRED**

All persons who are employees or agents of the Office of the Sheriff of Charles County, Maryland, are responsible



**Administrative and Operational Manual**

**September 12, 2022**

for the contents of the Manual as it exists in either paper or electronic format and as such, are to obey the rules, policies, and procedures contained therein. Employees and agents further understand they are responsible for all Manual revisions and updates. Sworn personnel and corrections officers will know from memory those sections of this Manual which deal with arrest, use of force, handling of prisoners, and the emergency operation of vehicles.

If the performance of a particular position requires that some information within the Manual be known without references to the Manual, the employee in that position will maintain that level of knowledge. No excuse for poor performance based upon lack of knowledge of the Manual will prevail.

The Manual will be referred to for guidance in situations where it may apply, and knowledge from memory will not suffice. This practice will be followed in those cases where normal functions of the employee's position permit such timely references. Otherwise, the employee will commit such sections, as needed, to memory.

## **0-002 PROCEDURES FOR DISSEMINATION, AUDITING, AND STORAGE OF AGENCY WRITTEN DIRECTIVES**

An electronic copy of the most current AOM and current SOPs will be published on the Agency Intranet, available to all personnel.

Changes and updates to the AOM are posted on the PowerDMS system for review and signature. The server for the Intranet and PowerDMS are backed up and copies of the AOM and SOPs are maintained on the Planning shared network drive for immediate backup access.

Each new employee is provided instructions on how to locate and sign for the Agency AOM and individual policy updates through PowerDMS during their new hire orientation. New employees will also complete a Manual Agreement Form #458 acknowledging the instruction was received.

The Agency auditing process with regard to knowledge of the Manual is as follows:

- All AOM updates and changes will be placed on the PowerDMS system;
- Upon the release of policy updates on PowerDMS, the copy of the AOM posted on the Agency Intranet will be simultaneously updated to reflect those policies being released;
- A notification email will be sent to all personnel Agency-wide, containing a description of new material posted on PowerDMS;
- Each employee is responsible for reviewing and signing for this material. Typically, a 30-day deadline will be set for all employees to review and sign for the material;
- The Deputy Director, Planning & Accreditation may coordinate with commanders/subject matter experts to administer periodic testing of Agency personnel on PowerDMS after a Manual or individual policy revision is published. The testing shall be directed toward recently issued revisions of the Manual or those areas of the Manual which are critical to the operation of the Agency;
- The results of the testing shall be monitored by commanders.

Commanders and supervisors shall regularly monitor PowerDMS to ensure employees under their supervision are signing for policies placed there and are completing any tests associated with new policy. This does not relieve the employee from his obligation to know the contents of the Manual, and no defense of lack of supervisory instruction will prevail.



Administrative and Operational Manual

September 12, 2022

### 0-002.1 GRAMMATICAL CONSTRUCTION

Within the Manual, the use of masculine and feminine pronouns is avoided if practical. In those cases where the writer uses the masculine pronoun in referring to Agency personnel in general, the feminine pronoun is hereby specifically included. Similarly, plural references include the singular, and vice versa. "Will" and "shall" are mandatory verbs, and "may" and "should" are permissive.

### 0-002.2 SOURCE REFERENCES

Some of the material contained within the Manual is a compilation or synopsis of other sources. When this is specifically relevant to a particular section of the Manual, citation of the reference materials are not generally provided, but there will be a notation to refer elsewhere in policy for the relevant material. Persons using this Manual are required to consult these sources, in cases where amplified information is necessary.

## 0-003 ORGANIZATION OF THE MANUAL

The Manual is divided into chapters, sections, and sub-sections for ease of use and referral. Sites of the Manual are in the following manner: 3-401.6 where 3 is the chapter, 401 the section and 6 the subsection. Alternately the reference could read: Chap. 3, Sec. 401.6. The chapters and sections of the Manual generally contain the following information:

- **Table of Contents**

The Table of Contents gives a quick overview of the sections of the Manual and materials to be found within them. The Table of Contents can aid in the finding of material when the reader is not sure of a specific title or the reader wants to browse the information contained within the Manual.

- **Introduction**

The Introduction contains a description of the Manual and defines its purpose. It also generally explains the Manual's form and functions.

- **Chapter 1**

The mission statement of the Agency and its current and future goals as described in the Strategic Management Program (SMP) are stated. The professional ideals and ethics for Agency personnel are outlined.

- **Chapter 2**

The Agency organization is defined and displayed in organizational charts. The various positions within the Agency, as well as duties and responsibilities of administrators, directors, and supervisors, and explanations of divisions, sections, and sub-sections are included.

- **Chapter 3**

The administrative policies and procedures of the Agency are defined and explained. Uniforms and employee appearance are also presented.

- **Chapter 4**

The operational policies and procedures of the Agency are defined and explained, based on the overviews



**Administrative and Operational Manual**

**September 12, 2022**

presented within each division's portion of Chapter 2.

- **Chapter 5**

The Administrative Reporting Program and methods of data collection and reporting are defined and explained. Examples of various documents and reports can be found in this chapter.

- **Chapter 6**

Risk management and safety policy is provided.

- **Special Orders**

Special Orders contain supplemental materials which are temporary in nature, generally not having a useful life of more than one year. These documents will, however, have a significant impact upon the operation and administration of the Agency during their useful life. Current pay charts are also included in this section.

## **0-004 REVISIONS AND NEW MATERIAL**

When it is evident that some area of the Manual should be revised, updated, or deleted, an email should be addressed to Planning & Accreditation, through the employee's chain of command, explaining the circumstances. All Agency personnel may submit recommendations for improvements to the Manual. These may be as simple as a citation of the area of the Manual and why or how it should be changed or the submission of a completed example of the change or addition.

The following sections detail the revision process.

### **0-004.1 RESEARCH**

Planning & Accreditation shall conduct research concerning the subject matter of Manual revisions. This research shall include the review of any material submitted to Planning & Accreditation by the Sheriff or other person noting the need for the Manual revision. It will also include the consultation with members of the Agency who may have special expertise in the subject matter area. Outside organizational planners, the manuals of other agencies, law books and law references, library materials, and any other source material available will be referenced given the time constraints applied by the Agency to each particular revision. An electronic file will be established within the office of Planning & Accreditation for each Manual revision. This file will contain all materials associated with the revision. Included shall be at least:

- information and correspondence supplied to initiate the revision and all follow-up email correspondence with the initiator, subject matter experts, and other employees involved in the revision process;
- material developed by the research conducted in reference to the revision;
- each draft developed as a result of the revision process;
- any proposed changes to drafts and their source;
- the finally approved revision; and
- a completed Form #889 Policy Approval.

### **0-004.2 DRAFTS**

The Deputy Director, Planning & Accreditation, or designee, shall initiate the creation of a draft of the proposed revision to the Manual. The draft will be clearly labeled "Draft" and the number of the draft will follow the word "Draft." Each succeeding draft shall be numbered sequentially and no change made in a draft unless the next number in the sequence is assigned to the changed draft. When the Deputy Director, Planning & Accreditation is



**Administrative and Operational Manual**

**September 12, 2022**

satisfied that there is a reasonable draft ready to address the subject matter of the Manual revision, the draft will be circulated to the management staff of the Agency.

### **0-004.3 REVIEW OF DRAFTS**

Drafts shall be circulated to all Agency management staff to include at least:

- the Sheriff;
- Chief of Staff;
- the Assistant Sheriffs;
- Division Commanders / Directors;
- Deputy Directors / section commanders;
- the Agency Office of General Counsel;
- the President of FOP 24;
- the President of CCCOA.

Management personnel shall review those drafts and determine if there is any needed change. In this regard, the draft (except those specifically marked confidential) may be circulated among any subordinate personnel in order to receive advice from those who have special expertise in a particular area.

Suggested changes and other feedback will be submitted by Agency email to Planning & Accreditation by the due date indicated on the distribution email circulated with the draft. In keeping with both the FOP MOU and the CCCOA Agreement, personnel will have 15 days in which to review the draft policy. Planning and Accreditation will ensure all feedback received during the review period is shared with the commander or other employee responsible for the policy, for consideration.

In some cases, there may be a need to expedite this process and in those cases, with the approval of the Sheriff, Chief of Staff, or one of the Assistant Sheriffs, the draft review outlined in this section may be omitted. In these cases, the policy may be subject to an abbreviated review process. Generally, an abbreviated review will include the Sheriff, Chief of Staff, Assistant Sheriffs, and the General Counsel.

### **0-005 COMMAND REVIEW**

When Planning & Accreditation, in coordination with the commander or other employee responsible for the policy, has considered all suggested changes as a result of the management review process and made appropriate changes, the resultant draft will be presented through the chain of command to the Assistant Sheriffs and/or Chief of Staff for approval. The Commander, Executive Services Division may forward the policy to the Office of General Counsel for legal review if he believes there is need for such review. The Assistant Sheriffs / Chief of Staff may approve the policy or defer for approval by the Sheriff.

### **0-006 OFFICE OF GENERAL COUNSEL APPROVAL**

Each policy, when submitted for final approval, may be submitted to the Office of General Counsel to be reviewed for legal sufficiency. The Office of General Counsel shall review each policy submitted to them and formally approve or make final recommendations to the Assistant Sheriffs / Chief of Staff. Some policies may have this step omitted if the Commander, Executive Services Division feels the change is not significant enough to warrant such legal review.



**Administrative and Operational Manual**

**September 12, 2022**

**0-007 SHERIFF'S APPROVAL**

Each policy will be approved by the Sheriff, Chief of Staff, or one of the Assistant Sheriffs acting upon delegated authority from the Sheriff. Only one of these signatures is needed to show an official approval; however, at the discretion of any of these, all four may sign a particular policy.

**0-008 DISTRIBUTION**

Upon approval of the Sheriff or his designee, Planning & Accreditation shall distribute the approved policy to Agency personnel. This requirement shall be fulfilled when the policy is placed into the PowerDMS computer based distribution system. Policies will be placed on PowerDMS with all additions, modifications and deletions highlighted to provide a comprehensive understanding of the revisions made. Portions of text that are struck-through indicate text that is being removed from the policy.

All administrative, management, and supervisory personnel will monitor employee participation to make sure that each employee receives and electronically signs for these policies. Records of employee electronic signatures and any test results will be stored in the PowerDMS system. When a particular distribution and/or testing cycle is complete, the Deputy Director, Planning & Accreditation, or designee, and members of the Command Staff will have the option to create a report of the results.

Commanders, directors, and supervisors shall ensure that newly posted material is reviewed and/or instruction is given to confirm that staff is able to operate within the parameters of the new material.

**0-008.1 SHERIFF'S PREROGATIVE**

Nothing in this section is intended to abridge the Sheriff's prerogative to unilaterally make changes to this Manual, in any manner, as he may see fit. The procedures in this section shall, however, be followed unless the Sheriff approves deviations.

**0-009 STANDARD OPERATING PROCEDURES MANUALS**

Standard Operating Procedures (SOPs) are policies and procedures which generally affect only the personnel and functions of one particular unit, section or division of the Agency. Those SOPs are governed by the commander / director / deputy director of that section and are contained within the Standard Operating Procedures (SOP) Manual for that section.

Commanders / directors / deputy directors are hereby required to establish SOP Manuals when the provisions of this Manual are not sufficient for the purposes of the section. All SOPs are required to conform to policies and procedures contained in the Manual. All personnel within the section for which the SOP Manual is established, are bound by the dictates of that SOP Manual.

An electronic copy of each section SOP Manual will be provided to the Division Commander or Director in charge of the section establishing the SOP Manual. Each member of the section will be provided access to the section SOP Manual via the Agency Intranet.

The SOP Manual will be kept current, with changes and updates being made as needed. Each SOP will be reviewed at least annually by the current commander of that section, and all revisions or additions will be distributed up the chain of command to be reviewed by the division commander. If changes are warranted, they shall be made and the SOP updated at that time. If no changes are necessary, the reviewing commander shall notify their superior officer and Planning & Accreditation by way of email that the SOP does not need revision. It will then be re-issued



**Administrative and Operational Manual**

**September 12, 2022**

---

with the current date, which will indicate the SOP has been reviewed during that year. The division commander/director of the issuing section may disapprove or modify any provision of the SOP, subject to approval, or delegation of approval authority, by the Sheriff or his designee.





Administrative and Operational Manual

September 12, 2022

## CHAPTER 1 – MISSION, GOALS, AND STANDARDS

### 1-001 INTRODUCTION

The Charles County Sheriff is established by the Maryland Constitution and the laws of the state in order to provide law enforcement functions within Charles County. The CCSO is responsible for the maintenance of order and the delivery of police services to the citizens of Charles County. The Charles County Sheriff's Office (CCSO) is responsible for the care and custody of prisoners held in confinement within Charles County. The CCSO is also responsible for the security of the courts and such enforcement actions and official document service as may be required by a court. Also, the CCSO is responsible for the transportation, within Maryland, and return of prisoners who are extradited from other states.

#### 1-001.1 MISSION STATEMENT

The men and women of the Charles County Sheriff's Office are dedicated to service through superior performance. We believe mutual respect, trust and pride in our organization, combined with traditional values and innovative techniques, will ensure the community's right to a safe environment.

##### 1-001.1.1 VALUE STATEMENTS

The men and women of the Charles County Sheriff's Office are bound by the highest standards of conduct, as exemplified in the following values:

**PRIDE:**

**Professionalism** – We believe in delivering a level of service which will reflect the pride we have in our community and organization.

**Respect** – We believe in individual human dignity and the preservation of human rights under the rule and spirit of law, always treating others as we would like to be treated.

**Integrity** – We believe in maintaining the public trust by holding ourselves accountable to the highest moral and ethical standards.

**Duty** – We believe the protection of life is our highest priority.

**Excellence** – We are dedicated to service through superior performance.

#### 1-001.2 GOALS OF THE AGENCY

The general goals of the men and women of the Agency are to:

- provide professional, effective, and efficient services to the citizens of Charles County;
- develop a partnership with the citizens and other government agencies to ensure the safety and security of the Charles County community;
- deliver all services and conduct all activities of the Charles County Sheriff's Office in a fair and impartial manner which assures all citizens the benefits of these services and activities; and to
- continually strive to achieve a living environment within Charles County which allows the County's residents to go about their daily activities in safety and free from fear of criminal activities.



Administrative and Operational Manual

September 12, 2022

Hereafter stated are the general goals of the Charles County Sheriff's Office. Each component of the Agency has specific short-term and long-term goals. These components' goals are the responsibility of the individual commanders of each of the respective components. Commanders are charged with the responsibility of developing and utilizing goals in the management of their respective components. Goals will be:

- written;
- reviewed at least annually;
- developed with the input of employees and others; and
- pursued with the vigor necessary to assure their timely accomplishment.

### **1-002 COMBINED STAFFING ASSESSMENT, STRATEGIC MANAGEMENT PROGRAM (SMP), AND FISCAL YEAR BUDGET PROCESS**

The Strategic Management Program is intended to provide for the formulation, review, and annual updating of written goals and objectives for each division and its organizational components. This program is used in combination with Agency Staffing Assessments and the Budget Preparation Process to focus the efforts and resources available to the Charles County Sheriff's Office toward the accomplishment of the mission of the Agency. The program is developed by the Sheriff and his Executive Command Staff, along with participation from Agency employees. The Program has the following major functions:

- Workload and staffing assessment every four years, to include review of the allocation and distribution of personnel;
- Creation of a current multiyear plan, which includes:
  - short- and long-range Agency goals and objectives;
  - anticipated staffing and population trends;
  - anticipated personnel levels; and
  - anticipated capital improvement and equipment needs.
- Creation of the annual Fiscal Budget for the Agency.

Fiscal year goals are to be submitted on the SMP Goal Suggestion Form #357A. Goals are statements of what each division component wants to achieve. Fiscal year goals should be focused and achievable during the targeted fiscal year. Care should be taken not to set too many goals, as there is a risk of losing focus. Also, goals should be designed so they do not contradict and interfere with each other.

Objectives are specific, quantifiable, time-sensitive statements of what is to be achieved and when it will be achieved. Objectives should:

- Be measurable - What will happen and when?
- Be suitable - Does it fit as a measurement for achieving the goal?
- Be feasible - Is it possible to achieve?
- Have ownership - Are the people responsible for achieving the objective included in the objective-setting process?

**Example:**

**Goal:** To recruit and hire qualified police officers.

**Objective(s):** Research and analyze job market opportunities and identify three potential market



**Administrative and Operational Manual**

**September 12, 2022**

opportunities by June 1.

Conduct at least 1 recruitment meeting at specified locations quarterly.

Long-term goals should be listed at the end of the suggestion form. These are goals that enable long-term thinking, may be less tangible, and usually are achieved over a longer period of time.

The SMP contributes to the production of three Agency documents and updates the AOM to reflect any changes to the Agency's Mission Statement and general goals. The documents produced as a result of this process are:

- A Staffing Assessment Report from each division,
- The Agency's approved Fiscal Budget Book,
- The Agency Strategic Management Program Document.

The Executive Command Staff of the Agency will, each year, ensure the completion of the tasks necessary to support the Staffing Assessment, Strategic Management Program, and Budget process. A Chronological Overview Chart of the process is provided at the end of this Manual section. Work on this process will be for the fiscal year one year in advance.

### **1-002.1 STAFFING ASSESSMENT, ALLOCATION, AND DISTRIBUTION**

The intent of this policy is to provide for a means to calculate sufficient Agency staffing needs and provide for allocation and distribution of personnel among and within organizational components based on the nature or number of tasks, their complexity, and time required for completion. The process of allocating personnel to each organizational component also permits the Agency to determine the overall number of personnel required to meet its needs and fulfill its objectives.

The Commander / Director, Administrative Services, maintains position descriptions and an up-to-date Agency personnel staffing summary of all authorized positions, filled and vacant. This summary is available upon request for use in completing staffing assessments.

Division commanders shall strive to ensure, within the confines of the annual budget, that each component under their command is appropriately staffed, and that personnel under their command are properly allocated and distributed according to a documented assessment of measurable activities within each component. These staffing assessments will be conducted in March every four years and used in conjunction with the SMP and budget preparation process.

The method used to determine sworn staffing in patrol operations will differ from other components within the Agency. Non-patrol division commanders will have their personnel use the CCSO Staffing Analysis Worksheet as part of the process. The Patrol Division Commanders will use the Allocation Model for Police Patrol (AMPP) for overall staffing assessment of sworn patrol operations. Both spreadsheet programs will be available on the Agency Intranet.

### **1-002.2 NON-PATROL COMPONENT STAFFING ASSESSMENT PROCESS**

During this process, division commanders shall ensure a staffing assessment is made for each component under their command. A separate Staffing Analysis Worksheet is to be completed by each component employee, both civilian and sworn. As a result of these assessments, recommendations regarding additional manpower or redistribution of existing personnel will be documented using the Component Staffing Assessment Form #957. This form is to be completed by each unit supervisor or commander / deputy director / manager as delegated by the division commander. The person completing the Component Staffing Assessment Form shall generally use the following component level assessment criteria:

- Current staffing level: Identifies the current staffing level in the component (sworn and civilian).



Administrative and Operational Manual

September 12, 2022

- Staffing assessment: Provides an explanation of sufficiency or non-sufficiency of current staffing levels and identifies any relevant staffing considerations within the current year (i.e., long-term absences, positions held vacant due to budget, rotational assignments, etc.).
- Quantitative staffing summary: Identifies and summarizes any quantitative methods used by the component to assess staffing. If other methods in addition to the Component Staffing Assessment Form were incorporated into the assessment, that information should be included here.
- Equalization of staffing analysis: Describes how the staffing is distributed within the component and its impact on efficiency. Also describes any changes made since the last assessment and any impact on the operation.

The completed Component Staffing Assessment Form will be submitted through the chain of command to the division commander. Section commanders / directors / managers will review, endorse, and/or comment on their components' reports. Division commanders will review all the component reports, compile and summarize the reports, and provide an endorsement as to the staffing issues and priorities for the division for the specified fiscal year. This information shall be due to the Chief of Staff / Assistant Sheriffs in the form of a written report by May 1 of each year. A copy of the report will be provided to the Deputy Directors of Planning, Budgeting and Accounting.

### 1-002.3 SWORN PATROL OPERATIONS STAFFING ASSESSMENT AND ASSIGNMENTS

With the use of the Allocation Model for Police Patrol (AMPP), the Patrol Division Commanders can estimate patrol operations staffing level needs that are based on Agency established performance objectives and other relevant factors. The model is intended to establish the number of officers needed to answer calls for service and then build upon that to ensure enough officers are assigned to patrol operations to meet performance objectives. There are four primary performance objectives for patrol operations used in this model. They include:

- Visibility of officers – The public, as they carry out their daily activities, like to see police officers. They particularly like to see police officers in their neighborhoods. It is important for the police to be visible to citizens in order to make citizens feel safe and to deter potential criminal activity. Therefore, this model sets visibility objectives for patrol and determines how many officers need to be assigned to patrol to meet these objectives.
- Ability to meet response time goals for Priority 2 calls – It is crucial for officers to be able to respond quickly to a Priority 2 call. These calls involve potentially life-threatening situations. Therefore, the model takes into account the number of officers who need to be assigned to patrol operations in order to meet the Agency's response time goal for Priority 2 calls.
- Ability to meet response time goals for Priority 1 calls – It is also important for officers to be able to respond to Priority 1 calls in a timely manner in order to prevent the situation from escalating and to maintain citizen satisfaction with the response. Therefore, the model also takes into account the number of officers needed in order to meet the Agency's response time goal for Priority 1 calls.
- Having an officer immediately available to respond to a Priority 2 call – The department must have officers immediately available who can respond to a Priority 2 call for service. If all on-duty officers are busy on other calls for service and activities, then the responses to Priority 2 calls will be delayed. Therefore, a performance objective is set in this model for the percentage of Priority 2 calls for which there should be at least one officer available to respond. This model then takes that percentage into account in determining the number of officers that need to be assigned to patrol operations.



**Administrative and Operational Manual**

**September 12, 2022**

This model also takes into account additional performance objectives that are set by the Agency. First, officers are expected to spend a certain percentage of their on-duty time performing self-initiated or directed patrol activities such as enforcing traffic laws, stopping suspicious persons, routine patrol of neighborhoods and business locations, and patrolling locations known for criminal activity. Second, officers spend a certain percentage of their time on administrative activities such as training, court time, meal breaks, and tending to their patrol vehicles. The model takes these additional activities performed by officers into account when determining the number of officers who need to be assigned to patrol operations.

As part of the assessment, the staffing numbers obtained through the use of AMPP can be compared with the FBI national averages and the Maryland averages for officers per thousand citizens. These averages are available online from the Crimes in the United States and Crimes in Maryland publications.

In considering the equalization of patrol operations assignments, officers transferred to patrol districts from other assignments, including graduates from the Police Academy, should first be assigned to fill vacancies in the divisions' patrol squads that exist at the time of transfer. All patrol operations assignment requests, including those of officers currently assigned to patrol, will be reviewed by the division commanders. The commanders may take into consideration the following:

- Manpower allocation and distribution needs (including special certifications such as Taser, FTO, Intoximeter, DRE, Secondary Language, or rank, etc.);
- Performance evaluations;
- Seniority;
- Length of time on current shift;
- Recommendations by the officer's supervisor, taking into account where the officer can best serve the Agency and the division; and
- Consideration of requests by the officer.

#### **1-002.4 STRATEGIC MANAGEMENT PROGRAM (SMP) AND BUDGET PROCESS**

The Strategic Management Program (SMP) requires the formulation and annual updating of written goals and objectives for the Agency and for each major organizational component within the Agency. For purposes of this policy, a "major component" is a division or other component depicted on the organizational chart as the first or second level below the Agency's Office of the Sheriff.

The SMP process' intent is to formulate effective strategies that take into account external influences (budgets, citizen concerns, legislative / governing officials' concerns, etc.) on the Agency and looks at short- and long-term goals and objectives. The process helps to determine the Agency's mission, to set priorities, to build on strengths, and to correct weaknesses. Participants in the process should attempt to anticipate potential opportunities and problems. The SMP process will be closely linked with the staffing assessment and budget process of the Agency. Since many goals require the expenditure of Agency resources, the SMP process is designed to allow projected goal resources to be requested during the budget process and approval received before the SMP document for a particular fiscal year is finalized. It is important for time lines outlined in this program to be followed to allow this to occur as designed.

Each division commander is responsible for the formulation of fiscal year written goals and objectives for his particular organizational components and to have written multiyear goals and objectives that combine to form the Agency's Strategic Plan. The established goals and objectives will be continuously reviewed for completion, needed updates, or changes.



**Administrative and Operational Manual**

**September 12, 2022**

---

The Strategic Planning Process shall allow for input from all Agency personnel. The Agency Goal Suggestion Form is designed to solicit and collect this input. Commanders / directors, deputy directors, managers, and supervisors should encourage their subordinates to contribute their ideas to the planning process. These goal suggestion forms are to be gathered and evaluated by each division and used, as applicable, to assist in preparing thoughts about goals and objectives for the Agency and each division and its components.

An SMP overview will be provided to the Executive Command Staff and selected members of their staff in early July of each year. The Deputy Director, Planning & Accreditation will provide instructions for preparing draft goals, objectives, and time lines. The Deputy Director, Budgeting will provide guidance regarding the budget process.

Division commanders will prepare the first draft of their goals and objectives on the Agency Goal Suggestion Form and provide an electronic copy to the Chief of Staff or their respective Assistant Sheriff and the Deputy Director, Planning & Accreditation by mid-August of each year. This first draft need not include budget information. The Deputy Director, Planning and Accreditation will compile the first draft of the SMP Document by no later than August 31 of each year and provide the Chief of Staff, Assistant Sheriffs, division commanders and the Deputy Director, Budgeting with an electronic copy.

Each division commander will review the first draft to ensure accuracy and will complete required fact finding and gather financial information needed for the budget process, to include, but not limited to: staffing costs from Budgeting, item costs from the Quartermaster, and computer-related costs from IT. This information will be provided to the Deputy Directors of Planning and Budgeting by September 1 of each year.

The Deputy Director, Planning and Accreditation will compile the second draft of the SMP document, which will include anticipated staffing, population trends, personnel levels and calls for service charts from the Crime Analysis Function. He will also obtain the current staffing summary from Human Resources. The Deputy Director will provide an electronic copy to the Chief of Staff, Assistant Sheriffs, division commanders and the Deputy Director, Budgeting prior to the scheduled SMP conference.

An SMP conference will take place in mid-September of each year as scheduled by the Chief of Staff. Members of the Executive Command Staff and other staff, as needed, should attend the conference. The first item on the agenda will be a review of the Agency's Mission, Goals, and Values as written in the AOM and any suggestions for changes or updates made. The Deputy Director, Planning & Accreditation will be responsible for making any updates needed to the AOM.

As part of the conference, division commanders should be prepared to discuss their reports pertaining to the status of goals and objectives from the most recent fiscal year. The second draft of the SMP document will then be reviewed and current division / component suggested goals and objectives may be openly discussed. Priorities, goals and objectives may be refined, changed, or deleted as needed. The Deputy Director, Planning will note any suggestions or changes needed. After goals have been reviewed, the Deputy Director, Budgeting will discuss the up-coming budget process and answer any questions about the overall process and completion of forms used during the process.

The Deputy Director, Planning will make whatever changes may be needed to compile the third draft of the SMP plan and submit an electronic copy to members of the Executive Command Staff. With the concurrence of the Executive Command Staff, the Deputy Director will then publish the third draft of the SMP document on the Agency intranet no later than October 15 of each year.

Between October 15-31 each year, the Deputy Director, Budgeting will provide other required budget request forms to division commanders (contracts, supplies, etc.).

By the end of October of each year division commanders / directors, with input from other staff, will complete -grant requests and submit them through the chain of command to Deputy Director, Planning and Accreditation.



**Administrative and Operational Manual**

**September 12, 2022**

---

The SMP and budget requests will be combined into draft one of the SMP and Budget document. This document will be presented to the Sheriff, Chief of Staff and Assistant Sheriffs for their review. Work sessions, with the Deputy Director of Budgeting, will be conducted as needed to make any necessary adjustments. Draft number two of the combined document will then be created by the Deputy Director, Budgeting. The Deputy Director, Budgeting will access the County's online budget software in mid-November to enter operating requests.

By December 1 of each year the Sheriff's Office preliminary budget requests will be compiled and finalized online with the County's Fiscal Services for initial review by the County Commissioners. In mid-December, the Deputy Director, Budgeting will supply to the Deputy Director, Planning and Accreditation an updated SMP document that reflects the items being requested. The Deputy Director, Planning and Accreditation will update the SMP document on the intranet.

From December to May of each year County budget work sessions are held with the County Commissioners and their staff. During April and May of each year public hearings are held concerning the overall County budget, including the Sheriff's Office budget.

During May through June of each year budgets are adopted, goals and objectives are reviewed, and performance measures for each goal are recorded and forwarded to the County's Budget Office.

In June each year, the Deputy Director, Planning and Accreditation will publish the final SMP document with staffing assessments, goals and objectives, and budget documents as a working document for the upcoming fiscal year beginning July 1. The final document will reflect input from the Deputy Director, Budgeting regarding items adopted in the budget.

During June through July of each year the final approved Budget Book is prepared upon acceptance and approval of the Strategic Management Plan and budget documents by the Sheriff.

Each division commander shall ensure review and follow-up on the goals and objectives in the final Strategic Management Program document. At the end of each quarter during the fiscal year, each division commander shall submit to the Chief of Staff or their respective Assistant Sheriff and to the Deputy Director, Planning, a brief written summary of the progress made, problems with, revisions needed, or accomplishment of, their goals and objectives.



## Administrative and Operational Manual

September 12, 2022

**1-002.5 CHRONOLOGICAL OVERVIEW OF THE SMP AND BUDGET PROCESS**

March 1 of every 4 years	Division Commanders will begin the staffing assessment process within their divisions.
May 1 of every 4 years	Division Commanders will present a written staffing assessment report. This report will be submitted through the chain of command to the Sheriff. Copy to Deputy Director, Planning.
July 1 to June 1 of each year	Goal suggestion forms are gathered and evaluated by the various commands, and the staff of each command works on development of goals, objectives, and time lines.
Early July of each year	Overview of SMP provided to Executive Staff and selected members of their staff by the Deputy Director, Planning & Accreditation and Deputy Director, Budgeting.
By mid-August of each year	Division Commanders will prepare the first draft of their goals and objectives on the Agency Goal Suggestion Form and provide an electronic copy to the Chief of Staff or their Assistant Sheriff and the Deputy Director, Planning & Accreditation.
By August 31 of each year	Deputy Director, Planning & Accreditation will compile the first draft of the SMP Document for the following fiscal year and send a copy electronically to each member of the Executive Staff and the Deputy Director, Budgeting.
Prior to SMP Conference each year	Planning & Accreditation compiles the second draft of the SMP Document with changes, additions or deletions.
Mid-September of each year	SMP Conference meeting takes place at a time and place as set by the Commander, Executive Services Division.
Mid-September to October 1 of each year	Members of the Executive Staff will complete required financial information and fact findings. Staffing costs, items cost from Quartermaster and related computer information from Information Technology.
By October 1 of each year	Cost gathering is provided to Budgeting and Planning.
October 15 of each year	Planning & Accreditation publishes the third draft of the SMP Document on the intranet. Information supplied by the various members of the Executive Staff as a result of the cost gathering.
Between -October 15 to October 31 of each year	Other budget request forms to Commander (contracts, supplies, etc.) - Section 5, 6, 7, and 8.
By end of October of each year	Completed budget request forms due to Budgeting, including current grants.
End of October - Early November of each year	SMP and budget requests consolidated - Draft #1.
Early November of each year	Budget Draft #1 given to Sheriff and Assistant Sheriffs for their review. Work sessions to make any changes or cuts. Planning & Accreditation in attendance. Draft #2 is generated with changes.
Mid-November of each year	Budgeting online access to County's budget software for entry of operating requests.
December 1 of each year	Sheriff's Office requested preliminary budget finalized online to the County's Fiscal Services for their initial compilation for County Commissioners' review.
Mid-December each year	Deputy Director, Planning and Accreditation re-publishes SMP document on Agency intranet reflecting updates from Deputy Director, Budgeting regarding budget requests.
December - May of each year	County budget work sessions with Commissioners and County Budget staff.
April - May of each year	Public hearing for County budgets, including Sheriff's Office.
May - June of each year	Budgets adopted. Goals and objectives reviewed; and performance measures for each goal are recorded and forwarded to the County's Budget office.
June of each year	SMP Document reflecting items adopted in the budget, is re-published as a working document for the up-coming fiscal year beginning July 1.
October, January, April and July of each year	Division Commanders will present a brief written summary of the progress made, problems with, revisions needed, or the accomplishment of goals and objectives, directed through the chain of command to the Sheriff.
June - July of each year	Final Approved Budget Book prepared.

**NOTE:** Budget dates are subject to change, based on the County Commissioners' calendar and approval.

**NOTE:** All dates contained within this section are expected to be adhered to as published; however, it is to be understood that changing circumstances of law enforcement operations may impact all or any component's ability to comply in every case. It is also possible that dates for all components may need to be adjusted to compensate for special events, natural disasters, or other causes. In any of these cases, the Chief of Staff may make such adjustments as necessary. Such adjustments will be in writing from the Chief of Staff to the Executive Staff.

From the SMP process

From the Budget process





Administrative and Operational Manual

September 12, 2022

## 1-003 AGENCY SUCCESSION PLAN

Succession planning is the process of preparing employees of the Agency for leadership roles. This process should provide individuals with the training, mentoring and support necessary to assume an essential role within the Agency when a vacancy occurs.

The Agency Succession Plan will allow the Agency to cultivate a crop of employees who, when ready, can assume a leadership position within the Agency. The Agency Succession Plan will also help preserve the continuity of operations within the Agency, by providing a group of employees ready to assume leadership positions at a moment's notice.

### 1-003.1 OVERSIGHT OF THE AGENCY SUCCESSION PLAN

The Agency Succession Plan shall fall under the sole purview of the Sheriff. The Agency Succession Plan will be tailored by the Sheriff in order to best meet the needs of the Agency as a whole. These needs can include accounting for attrition within the Agency, ensuring the Agency is able to maintain continuity of operations when an essential position is not filled and any other needs as determined by the Sheriff. At the discretion of the Sheriff, the Executive Command Staff may also provide insight during the planning, implementation and adjustment of the Agency Succession Plan.

### 1-003.2 ESSENTIAL POSITIONS

Essential positions include, but are not limited to:

- Sheriff
- Chief of Staff
- Assistant Sheriff of Operations
- Assistant Sheriff of Administration
- Division Commanders
- Section Supervisors
- Administrative Sergeants
- Director, Charles County Detention Center
- Deputy Director, Charles County Detention Center
- Accreditation Manager
- Grant Coordinator
- Property Management personnel
- Office of Professional Responsibility personnel
- Information Technology personnel

### 1-003.3 PLANNING FOR AGENCY ATTRITION

The Agency has a number of ways to prevent the negative effects of attrition.

- The Deferred Retirement Option Program (DROP) allows the Agency to plan ahead for anticipated openings in sworn positions. Awareness of retirement, sometimes years in advance, allows the Agency to strategize and keep essential positions filled at all times.
- When an employee in an essential position alerts the Sheriff that they intend to separate from the Agency, the succession plan will be utilized to ensure that the essential position remains filled.



Administrative and Operational Manual

September 12, 2022

The Sheriff, or his designee, will work with the Agency Human Resources Section and the Agency Budgeting Section to determine the most effective way to address attrition within the Agency. This could include, but is not limited to:

- Early or acting promotions of personnel;
- Early hiring of personnel; and
- Hiring additional sworn officer candidates, potentially over authorized strength.

**1-003.4 DEVELOPMENT AND MENTORSHIP OF EMPLOYEES**

Some key characteristics in succession plan candidates are:

- Interest in assuming an essential position within the Agency;
- Documented ability to successfully manage challenging tasks; and
- Evidence of taking initiative to improve performance throughout their careers.

Employees should be encouraged to attend courses that expand their skillsets and give them experience and insight into leadership positions. These courses and trainings include, but are not limited to:

- Leadership in Police Organizations (LPO);
- The Law Enforcement Executive Development Seminar (LEEDS);
- The FBI National Academy;
- The FBI Trilogy Training;
- FBI Executive Leadership School;
- Maryland Sheriffs and Chiefs – Aspiring Leaders Training;
- Charles County Sheriff’s Office – Leadership Program;
- Northwestern University SPSC;
- Johns Hopkins University Training; and
- ICS training.

**1-100 STANDARDS**

Standards are yardsticks by which an agency or individual may be measured in order to determine if an expected level of achievement or excellence is met. Hereafter are listed the standards by which the Charles County Sheriff’s Office and its personnel will be measured. Although it could be argued that no person or agency will completely achieve the standards, it is nonetheless expected that all personnel will continually work and strive to do so.

These standards are not to be considered in the abstract. Instead, each employee should personally work to achieve the degree of excellence of performance necessary to meet them. Purposeful shortfalls will be grounds for disciplinary action; however, this is not the primary reason for their existence. These standards are primarily intended to set the tone of service expected from all Charles County Sheriff’s Office employees.

**1-100.1 OATH OF OFFICE**

All personnel, prior to assuming sworn status as active law enforcement officers, shall take an oath of office to enforce the laws of Charles County and State of Maryland and to uphold and defend the Constitutions of the State of Maryland and the United States. The “Oath of Office of a Deputy Sheriff” as executed by the Clerk of the Circuit Court for Charles County is to be used for this purpose. The oath of office is administered to police recruits prior to graduation from the Southern Maryland Criminal Justice Academy. However, by order of the Sheriff, police recruits shall not legally exercise the authority of a police officer or deputy sheriff until being issued a provisional or standard certification by the Maryland Police Training and Standards Commission under the authority of the Charles County Sheriff’s Office.



Administrative and Operational Manual

September 12, 2022

## 1-100.2 AGENCY IDENTIFICATION

All employees are issued an Agency photo identification card which is to be carried at all times while on duty. With the exception of police recruits, sworn employees of the Agency are considered to be always available to perform the duties of their office. Sworn employees will carry their badge and identification card on their person whenever they are armed. When on duty or acting in an official capacity, employees will display their ID and give their name and identification number to anyone who requests them. This does not include officers in covert assignments or those in assignments which would be jeopardized by divulging such information.

## 1-101 ETHICS

Maryland Public Ethics Law sets standards of conduct for State and local government officials and employees to guard against improper influence on public officials or the appearance of conflict of interest through programs of financial disclosure, lobbying disclosure and regulation, approval of local government ethics requirements, ethics law advice and training, and ethics law complaint investigation.

A basic role of government is to provide an environment conducive to human growth and endeavor, free from artificial or arbitrary intrusion. To that end, laws are made and enforced for the common good of society. It is the role of the police to stand as the defender of that social contract between citizens and their government. To accomplish this goal, certain professional and personal traits are essential; therefore, members of the Charles County Sheriff's Office shall:

- protect and safeguard lives and property; and
- protect the community from deception, oppression, intimidation, violence, and disorder; and
- support and protect the constitutional rights of all citizens to liberty, equality, and justice; and
- maintain exemplary personal traits of honesty, morality, self-restraint, courage, obedience to the law, and respect for the rights and liberty of all persons; and
- recognize the badge and oath of office as a personally binding commitment to public office, public trust, and professional ethics, surmounting personal feelings or prejudices that may denigrate one's oath; and
- professionally execute official duties, regardless of the race, sex, religion, or financial status of persons requiring assistance; and
- display a commitment to law enforcement with courtesy, without fear or favor, malice or ill will, without using unnecessary force, and without accepting gratuities.

An official or employee may not retaliate against an individual for reporting or participating in an investigation of a potential violation of the Maryland Public Ethics Law.

All employees are subject to the Maryland Public Ethics Law, which is in Title 5 of the General Provisions Article of the Maryland Code. The Training Division will be responsible for providing ethics training to all Agency personnel at least biennially.

## 1-102 USE OF DISCRETION BY SWORN OFFICERS

Discretion is defined as the freedom or authority to make decisions and choices within legal confines. Sworn officers are expected to use reasoned and impartial discretion in the performance of their duties. Recognizing that some decisions will be especially difficult and made in emergency situations, officers are legally, professionally, and



**Administrative and Operational Manual**

**September 12, 2022**

personally bound to exercise those judgments within the confines of their oath of office and their obligations to the law, the Office of the Sheriff, and the citizens of Charles County.

When an officer in the performance of his duty elects to exercise discretion, he must consider:

- all the facts and circumstances surrounding a particular event;
- the seriousness of any criminal offense(s) committed;
- mitigating circumstances; and
- the interests of the public and the Agency.

The use of discretion shall be considerably limited in domestic violence and felony cases. Officers will be held accountable and must be prepared to justify their actions in these incidents. Greater leeway in the use of discretion is permissible in the investigation of misdemeanors, civil offenses, and juvenile cases, especially when dealing with status offenders.

### **1-103 UNBECOMING CONDUCT**

Employees are held bound to avoid excessive, unwarranted, or unjustified behavior that would reflect poorly on themselves, the Office of the Sheriff, or the Charles County Government, regardless of duty or work status.

#### **1-103.1 UNPROFESSIONAL LANGUAGE**

Employees will refrain from using harsh, violent, profane, or derogatory language, which would demean the dignity of any person.

### **1-104 USE OF FORCE**

Sworn officers may find they need to use physical force in situations which cannot be otherwise controlled. Reasonable force may be used when other alternatives have been exhausted or would clearly be ineffective under the particular circumstances. In no instance may the use of force be more than is necessary to achieve a lawful purpose.

Non-sworn personnel of the Agency may only use force in circumstances where an ordinary citizen would be justified in using force to protect themselves from attack or in situations that would be justified by law. Employment with the Agency does not convey authority to carry or use weapons of any kind to non-sworn employees (except that, corrections officers shall carry and use weapons as required by a particular job assignment).

### **1-105 DE-ESCALATION**

If time, circumstances and safety permit, employees should attempt to gain compliance through de-escalation as opposed to the use of physical force. De-escalation could slow down or stabilize encounters to allow for more resources or options to better resolve the conflict. Examples of de-escalation techniques include but are not limited to the use of advisements, warning, or persuasion.

### **1-106 INTEGRITY**

The personal and collective integrity of the Charles County Sheriff's Office is one of the foremost responsibilities of all employees. The dishonesty of a single employee may impair public confidence in the entire Agency.



**Administrative and Operational Manual**

**September 12, 2022**

**1-107 RELATIONS WITH VENDORS AND CONTRACTORS**

All employees representing the Agency in business transactions with outside business organizations or private vendors shall conduct themselves in a fashion that reflects favorably on them and the Charles County Sheriff's Office. The acceptance of gratuities or benefits of any kind is prohibited.

Agency resources will not be committed to furthering the work of a prospective contractor or vendor prior to the formation of a contract. Employees will be aware of, and conform to, the conflict of interest provisions of the Maryland Public Ethics Law.

**1-108 ENDORSEMENTS**

Employees are prohibited from using their official capacity, title, or position to endorse any products, organization, program or service without the expressed permission of the Sheriff.

Officers are prohibited from representing themselves in an official capacity, either in or out of uniform, before any hearing or licensing board when their appearance before such a board is not an official act, required of them as a member of the Charles County Sheriff's Office and authorized by the Sheriff or his designee.

**1-109 PRIVATE COMPENSATION OR REWARD**

No compensation, reward, or other consideration from private sources shall be solicited or accepted by members of the Charles County Sheriff' Office, without specific permission from the Sheriff. When presented with an individual reward or compensation, the employee shall explain that individual compensation is not allowed. If the citizen or business insists, accept it and forward it through the chain of command to the Sheriff with a memorandum detailing why and how the reward/gratuity was received.

**1-109.1 DONATIONS TO THE AGENCY**

Donations to the Agency, without reference to specific employees, do not have the same rules as donations to individuals, but may still generate ethical concerns. As a general rule, the more broad the donation, the less of an issue is presented. For example, there is no issue if an organization or individual brings donuts to District I on Tuesday, brought donuts to a high school on Monday, and is taking donuts to a fire station on Wednesday. Donations to the Agency should be handled by a supervisor and forwarded through the chain of Command to the Commander of Executive Services. Donations intended as a thank you for a particular event should be politely discouraged. When possible, employees receiving donations to the agency should obtain contact information for the donor. In the case of a cash donation, the Executive Services Commander will submit to finance to deposit accordingly. The Executive Services Commander will forward non-cash donations to the Sheriff to determine disposition.

No policy can cover every scenario an employee of the Charles County Sheriff's Office might encounter. You may be required to exercise your best judgment to determine if what the citizen or business is offering is a donation to the agency as a whole, which is allowable, or is an individual compensation to an employee, which is not. Request guidance from a supervisor or superior officer if necessary, to make a determination.

**1-109.2 DONATIONS OF PERISHABLE ITEMS**

When possible, the employee presented with a donation of perishable items should ask if the donor is providing similar services to other entities. If the donor is providing similar services to other entities, the perishable items may be accepted and shared.



Administrative and Operational Manual

September 12, 2022

### 1-109.3 DISCOUNTS ON GOODS AND SERVICES

Businesses sometimes offer discounted goods and services to members of police agencies, first responders or military. Many do this as a broad gesture of appreciation for the jobs these employees perform.

Because the businesses afford this gesture to job types as a whole and it is not intended as an individual gratuity, this is allowable. However, under no circumstances will an employee expect such discounts and will always be prepared to pay full price for any item or service. An employee of the Charles County Sheriff's Office shall not use his employment to solicit favors or discounted goods or services from any business or vendor at any time whether on- or off-duty. To do so is unprofessional, unethical, and may subject the employee to disciplinary action.

Nothing in this policy is meant to prohibit an employee from negotiating in good faith the purchase of goods or services which are normally negotiable; i.e., homes, vehicles, etc. Further, it does not prohibit an employee from soliciting funds, goods, or services on behalf of a fraternal or civic organization while acting as a member of, or on behalf of, that organization.

### 1-109.4 JURY DUTY

Jury duty is the civic responsibility of every eligible citizen. It is usually expected that when called, members of this Agency will serve. Employees with a personal need to be excused will present their request directly to the courts.

Any employee summonsed for jury duty will notify his supervisor without delay and provide that supervisor with a copy of the jury duty notice. The supervisor will forward a memorandum, with a copy of the notice attached, up the chain of command to the Division Commander.

Employees who report for jury duty will be permitted to be absent from their duties, as needed, without loss of pay or a charge against any leave. Employees selected to serve on jury duty will be allowed to retain the jury duty fee for associated expenses.

If an employee is selected to serve as a juror for a trial, they will not be required to report for any shift that begins on the same date. The employee shall report for duty if the employee's service as a juror is not required or upon completion and if more than half of their shift remains, including travel time. If the employee is scheduled to work evening shift, they will report to work as scheduled once released from jury duty. Employees who are scheduled to work midnight shift and are required to report for jury duty the following morning, will not be required to work that midnight shift.

Employees selected to serve in a grand jury will be permitted to be absent from their duties, as needed, without loss of pay or a charge against any leave for each day of service during a scheduled workday.

### 1-109.5 WITNESS FEES

When an employee is to receive witness fees and/or travel and related expenses for testimony in a court case or other proceeding arising out of the exercise of his official duties, the employee may choose to:

- Attend the hearing on his own time (leave or day off) using his own transportation and accept any witness fees and expenses offered; or
- Attend the hearing during duty hours or as overtime, using a Sheriff's Office vehicle for transportation, and in this case the employee will turn over any witness fees and associated travel and expense allowance to the Commander / Director, Administrative Services for deposit to the Sheriff's operating fund.



**Administrative and Operational Manual**

**September 12, 2022**

When an employee is to receive witness fees and/or travel and related expenses for testimony in a court case or other proceeding not arising out of the exercise of his official duties, the employee, will be on his own time (leave or day off), and may retain the witness fee and expenses.

**1-109.6 USE OF LABOR FOR PUBLIC PURPOSE**

The following persons who are supervised by Agency personnel will be used only for public purposes:

- employees;
- contractors;
- volunteers;
- Volunteers in Community Service;
- Charles County Detention Center trustees;
- any other trustee or prisoner;
- persons who otherwise serve under the supervision of an employee; or
- a person who could reasonably be expected to believe he/she was subject to obey the request or direction of the Agency employee because of the employee's position with the Agency.

They will only be required and/or allowed to accomplish work which is primarily the responsibility of the Agency or falls within the discretionary responsibilities of the Agency as dictated by Agency policy or order of the Sheriff or designee.

Such persons shall not be used for work which is a personal benefit to the supervising employee or any other person who is not designed to be a recipient of such benefit because of Agency responsibilities or policy. No employee of the Agency may personally receive, directly or indirectly (through a family member or business interest), any compensation or other benefit as a result of the work or activities of persons supervised in the context of Agency employment.

**1-110 COURTESY**

Courtesy in public contacts encourages understanding and appreciation; discourtesy breeds contempt and resistance. A courteous demeanor is entirely consistent with the firmness and impartiality that characterizes professional law enforcement employees. Employees shall display a fair, impartial, and professional attitude toward the public and perform work tasks in a business-like manner. Employees shall, in the normal course of their duties, address and deal with people in a courteous and respectful manner. This section should not be interpreted to prevent employees, in an emergency situation, from issuing commands or orders in an authoritative manner.

**1-111 COMPLIANCE WITH LAWFUL ORDERS**

The Charles County Sheriff's Office is organized within a clearly defined hierarchy of authority. This is consistent with the Agency goal of maintaining efficient law enforcement operations. It is expected compliance with lawful orders will be positive and reflect a willingness to serve. Compliance with lawful orders is a condition of employment. A lawful order is any direction given to an employee, by another employee of the CCSO who is superior in rank or position within the Agency, providing the order is:

- within the general realm of the duties defined by the employee's job description or because of exigent circumstances could reasonably be expected to be performed by the employee because of a responsibility thrust upon the CCSO by the circumstances; and
- not in direct violation of any Agency policy, providing the person giving the order does not have the discretionary authority to disregard in the instant circumstances; and



**Administrative and Operational Manual**

**September 12, 2022**

- not in violation of any law, regulation, or ordinance, providing such law would impact the instant circumstances.

An employee who is found to be wrong in refusing or failing to comply with a lawful order is insubordinate, and will be subject to disciplinary action, up to and including dismissal from employment. The employee could also face civil action, from sources other than the Agency, for failing to perform required duties.

If the receiving employee is found to be correct, and the order is unlawful, the employee will suffer no adverse action. In these cases, an investigation will be conducted to determine why the unlawful order was given. This investigation will be the responsibility of OPR. Results of this investigation may cause the creation of, or modification of, a training program; the remedial training of an employee or employees; or some form of disciplinary action, as may be warranted for the employee issuing the unlawful order.

In cases where an employee receives an order which conflicts with a previous order, the employee shall notify the person giving the conflicting order of the conflict. If the person giving the conflicting order indicates the second order is to be complied with, the employee shall comply with the second order and notify the person giving the first order of the circumstances of the conflict. This notification shall be completed as soon as practical and may initially be given verbally, but shall be followed up in writing within 72 hours. The person giving the second order shall be responsible for any circumstances or consequences arising from the conflict and shall bear full responsibility for the employee's lack of compliance with the first order.

For the purposes of determining who is in a position to give a lawful order, sworn and corrections officers are organized into a rank structure which defines this authority. Civilian personnel derive their authority to supervise by their position and responsibilities in the organization, as published in the AOM. Regardless of position, no civilian shall exercise direct operational supervision of sworn personnel in matters which impact the officer's sworn authority or powers of arrest. Civilians may exercise administrative supervision of sworn employees when it is appropriate to their position within the organization.

Failure to comply with a lawful order or directive is a serious breach of organizational discipline. Such violations will subject the employee to disciplinary action, which may include termination of employment.

### **1-113 ATTENTION TO DUTY**

All employees are expected to maintain a strong personal commitment to the proper performance of their duties. Sworn employees are considered subject to duty at all times and in all places within the geographical area of their authority. Sworn employees may be considered "off-duty" at times when they are not assigned specific work hours, but are responsible to assume a duty which presents itself and is within the scope of the essential functions of their positions.

### **1-114 FINANCIAL OBLIGATIONS**

Employees are expected to avoid incurring financial obligations which are beyond their ability to reasonably satisfy from their anticipated earnings. Employees shall pay their just debts and shall not sell or assign their salary. Neither shall employees refuse to promptly pay all legitimate indebtedness, claims, and judgments and they shall satisfy all executions which may be held against them.

### **1-115 IMMORAL CONDUCT**

Employees shall maintain a level of moral conduct in their personal and business affairs which is in keeping with the highest standards of the law enforcement community and the community at large. Employees shall not





**Administrative and Operational Manual**

**September 12, 2022**

participate in any incident involving moral turpitude which impairs their ability to perform their duties or causes the Charles County Sheriff's Office to be brought into disrepute.

**1-116 ASSOCIATIONS**

Employees shall avoid regular or continuous associations or dealings with persons whom they know, or should know, are persons under criminal investigation or indictment, or who have a reputation in the community or the Agency for present or past involvement in felonious or criminal behavior, except as necessary for the performance of official duties, or where unavoidable because of other personal relationships of the employees.

**1-117 FUNCTIONAL COMMUNICATION / COOPERATION**

With the understanding that many times official Agency business is confidential in nature and that all employees must adhere to confidentiality policies elsewhere in this Manual, the Charles County Sheriff's Office encourages and supports the exchange of information among all Agency functions and personnel for the purpose of coordinating Agency activities. There are a number of ways to communicate information, such as:

- attendance of investigative personnel at patrol shift briefings;
- holding staff meetings;
- use of email messages;
- use of voice mail and other electronic systems; and
- use of bulletins and newsletters.

Employees shall coordinate their efforts with all other employees of this Agency and the Charles County Government with the objective of ensuring maximum achievement and continuity of purpose through teamwork. All employees are charged with the responsibility of fostering and maintaining a high degree of cooperation, both within the Agency and in association with other law enforcement agencies and government departments.

**1-118 AID TO FELLOW EMPLOYEES**

In the performance of their duties, no employee shall fail to aid, assist or protect a fellow employee to the full extent of the employee's capability, being mindful of established rules and procedures which may bear upon the existing circumstances.

**1-119 REPORTING FOR WORK**

Employees shall report for work at the time and place required by assignment or instruction. They shall be properly attired and equipped and prepared to fulfill their duties. They shall give their undivided attention to orders, instructions, directions, and any other information directed to them or generally to employees.

**1-120 INSPECTIONS**

In order to fulfill the responsibilities of office, the Sheriff must at all times be familiar with the condition of facilities, equipment, and personnel within the Charles County Sheriff's Office. To maintain this familiarity and awareness, there is established a system of inspections. The system includes the inspection of personnel, equipment, vehicles, supplies, office space, and other physical locations used or occupied by the Office of the Sheriff. All command and supervisory personnel are charged, on both a random and scheduled basis, to continually inspect all that falls within their respective areas of responsibility.

Each commander shall, when assuming a command, inventory the entire command and accept responsibility for



**Administrative and Operational Manual**

**September 12, 2022**

all he finds at his disposal as a result of assumption of command. In like manner, each commander, in preparation for turning over a command to another, shall inventory his command and formally give an accounting of that which is to be turned over. Each such inventory shall include personnel inspections, as well as equipment, supplies, vehicles, and physical spaces occupied by the command.

Commanders shall conduct a bi-annual physical inventory of all supplies, equipment and vehicles. All physical spaces, personnel, equipment and vehicles shall be inspected at least quarterly by commanders. Supervisors shall monitor physical spaces, personnel, equipment and vehicles continually and shall conduct formal inspections at least monthly. All inspections shall be documented and the documentation maintained by the commander or his designee. Inventories will be conducted as prescribed in Section 3-306 of the AOM.

Discrepancies found as a result of the inspection process shall be corrected as they are found if the corrections are within the realm of the inspector's authority and resources. If not, they are to be brought to the immediate attention of the inspector's commander.

All equipment, uniforms, supplies, vehicles, physical spaces and all other things owned or under the control of the Charles County Sheriff's Office, which are assigned to the keeping of an individual employee, are subject to inspection and audit by both Sheriff's Office personnel and outside agencies who have been given the authority to conduct audits. If an individual employee under these circumstances places any personal security device in place, the employee's immediate supervisor will be supplied with the means to access the security device for purposes of inspection. Any personal property of any kind which is placed within the vehicles or physical spaces owned or controlled by the Sheriff is the responsibility of the individual employee placing it there. The CCSO assumes no responsibility or liability for such items. All such items are subject to the inspection procedure of this Agency. No item which would violate any rule, policy or law by its possession or use will be allowed in vehicles, physical spaces, or in the possession of employees of the Charles County Sheriff's Office.

**1-121 TRAINING**

Training is an on-going process critical to the continued effectiveness of any organization. All employees are encouraged to utilize available training programs to improve their knowledge and skills in the areas of their respective career responsibilities. Some training is mandatory for certain employees. For example, mandatory annual training, including firearms and weapons training, is required for each sworn officer in order to meet the Maryland Police Training and Standards Commissions' (MPTSC) certification. Personnel who have such a requirement must fulfill it.

The Agency will provide for all required training programs on at least an annual basis through the Training Division, Southern Maryland Criminal Justice Academy (SMCJA), roll-call training, outside training opportunities and other means. Required annual training will include a review of the Agency's use-of-deadly force policies, significant changes in other policies and a review of local, state and relevant federal law changes. A legal update document shall be provided to all sworn officers by no later than September 1 of each year by the Office of General Counsel. All supervisors / commanders of sworn personnel shall review the legal updates with their subordinates and instruct personnel concerning significant changes in the law. Supervisors / commanders shall ensure that this instruction be documented on either a training roster or on a Report of Training Form #182.

All training, other than in-service training, will be documented on the Form #182 and submitted to the Training Division. All Agency training records shall be maintained by the Commander, Training Division.

**1-122 EMPLOYEE HEALTH AND FITNESS**

The CCSO encourages all its employees to engage in appropriate exercise, periodical physical exams, and good nutritional habits as part of an overall healthy and physically fit lifestyle.

All persons must be able to perform the essential functions of their respective positions. It is therefore the responsibility of individual employees to maintain a level of physical conditioning which allows them to perform as



**Administrative and Operational Manual**

**September 12, 2022**

required. All Sheriff's Office employees have access to the physical fitness facilities at Headquarters and other Agency locations, and an Employee Fitness Program, described elsewhere in the AOM, has been created to assist employees achieve their fitness goals. Fitness charts are located on the Agency Intranet.

Police and correctional officers are routinely placed in situations which have the potential to become dangerous and/or physically demanding, and maintaining an appropriate level of physical fitness is essential. It is not uncommon for long periods of sedentary activity to be immediately followed by physically and mentally demanding situations. All sworn and correctional officers are encouraged to be fit as described in the Cooper Institute guidelines, which are available on the Agency Intranet and elsewhere in policy.

The Agency's goal is not solely to ensure that police and correctional officers are physically prepared to perform their duties, but to create an environment within the Sheriff's Office where healthy habits are encouraged for all employees, both personally and professionally.

**1-122.1 EMPLOYEE ON-DUTY EXERCISE TIME**

All Sheriff's Office employees are afforded one and one-half hours of on-duty exercise time per work week when practical and approved by their supervisor. This time does not accumulate; if the employee is unable to exercise due to work constraints during the work week, the one and one-half hours for that week does not carry over. Supervisors and commanders will make every effort to facilitate the on-duty exercise periods and encourage their subordinates to maintain a healthy lifestyle. Contractual agreements with active members of EST / ERT and any other special teams will not be affected by this policy; however, those already permitted on-duty time for exercise will not be granted this additional one and one-half hours.

An employee utilizing the on-duty exercise period may choose to exercise at one of the Agency owned and maintained facilities or may choose to use other facilities such as a personal gym or running / walking at a park. In either event, the time allotted for this purpose is designated to be used to exercise while on duty and not meant to be compensation for periods of time the employee exercises while off duty.

Since the employee is still on duty during this exercise period, they are subject to having their exercise time canceled and being called back to work by their supervisor if necessary. Because employees are subject to call back, any request to use this time to exercise at a location outside of Charles County will be denied.

**1-123 TRUTHFULNESS**

The nature of employment with a law enforcement agency requires that all employees be honest and trustworthy in all their personal and official business. The employees of this Agency are required, as an essential function of their positions, to give truthful answers to questions asked regarding official matters. No employee shall knowingly exclude information, which by its omission would be misleading or fraudulent. False and/or misleading statements are grounds for termination of employment.

**1-124 LOITERING, SLEEPING, MALINGERING ON DUTY**

No employee shall loiter, sleep or mangle on duty, or in any other manner shirk his responsibilities in the performance of duty.

**1-125 FEIGNING SICKNESS OR DISABILITY**

An employee shall be absent from duty because of sickness, only, when suffering from an illness or injury which would prevent the proper performance of duty. The employee shall not feign sickness or disability, nor attempt to deceive a supervisor concerning that employee's physical or medical condition. Notification of the use of sick and



**Administrative and Operational Manual**

**September 12, 2022**

safe leave will be made to the employee's supervisor prior to the scheduled reporting time for work.

**1-126 MEMBERSHIPS IN ORGANIZATIONS**

No employee shall become affiliated with any organization which in any way would prevent an employee from rendering proper service to the Agency. Membership in an armed forces reserve component of the United States is specifically excepted.

**1-127 POLITICAL ACTIVITY**

Employees may participate or refrain from participating, during off-duty hours, in partisan political activities, except where expressly prohibited by federal or state statute. There shall be no campaigning, fund-raising or electioneering on County property during business hours.

Employees shall not engage in partisan political activity during their hours of employment. Charles County Sheriff's Office equipment (e.g., uniforms, vehicles, badges, insignia, or business cards) shall not be used for political campaigning, fund-raising or electioneering activities.

Nothing in this section shall be construed to restrict the Sheriff from any political activity. The Sheriff, as an elected political official, is by the nature of the office continually engaged in political activities.

**1-128 PERSONAL PREFERMENT**

Employees shall not seek the influence or intervention of any person outside the Agency for purposes of personal preferment, advantage, transfer, advancement or to gain favor or preferential treatment of any kind.

**1-129 ADDRESSING RANKING OFFICERS**

Officers of a superior rank will be addressed with respect, using their rank or title in the address.

**1-130 RECOMMENDING LAWYERS AND/OR BONDSMEN TO PRISONERS OR OTHERS**

Officers are prohibited from recommending or suggesting to anyone the employment or name of any person, firm or corporation, attorney, counsel or bondsmen, except that nothing herein shall be construed as restricting the rights of members of the Agency in connection with administration of their private affairs.

**1-131 FALSE INFORMATION IN RECORDS**

No member of the Agency shall make false official reports, or knowingly or willingly enter or cause to be entered in any Agency books, records or reports any inaccurate, false or improper police information or material matter.

**1-132 DUTY TO REPORT INFORMATION**

It shall be the duty of every employee to properly report any information received in good faith from any citizen regarding matters which indicate the need for action by the Agency.

**1-133 CONFIDENTIAL INFORMATION**



Administrative and Operational Manual

September 12, 2022

Employees of the Charles County Sheriff shall treat as confidential the official business of the Agency. They shall not discuss or impart the same to anyone except those for whom it is intended, or as directed by their superior officers or under due process of law. Nothing in this section shall prevent the discussion of policy by those employees charged with policy creation, with their counterparts in other organizations or professionals in a particular field. A member of this Agency shall not disclose to any inquiry the employment status, performance, salary or any personal information concerning any employee, or former employee, of the organization. All such inquiries shall be directed to the Sheriff's Human Resources Office.

**1-134 HARASSMENT AND DISCRIMINATION**

No employee shall sexually harass another person. No employee shall unfairly treat or discriminate against another because of that person's race, color, religion, sex, age, national origin, marital status, sexual orientation, gender identity, genetic information, or disability.

**1-134.1 BIAS BASED PROFILING**

While profiling, in itself, can be a useful tool to assist law enforcement officers in carrying out their duties, bias based profiling is the selection, for law enforcement action, of individuals based solely on a common trait of a particular group. Bias based profiling includes, but is not limited to, taking law enforcement action based solely on a person's race, ethnic background, gender, sexual orientation, religion, economic status, age, culture, or some other identifiable characteristic. Bias based profiling undermines legitimate law enforcement efforts and can lead to claims of civil rights violations. Additionally, bias based profiling alienates citizens and fosters distrust of law enforcement by the community.

The Charles County Sheriff's Office prohibits bias based profiling by any employee during all contacts with the public. This includes, but is not limited to traffic contacts, field contacts, and asset seizure and forfeiture actions. This policy is intended to reaffirm the Agency's commitment to unbiased policing; to clarify the circumstances in which officers can consider race / ethnicity when making law enforcement decisions; and to reinforce procedures that are in accordance with Supreme Court findings and the Fourth Amendment rights of the people to be secure in their persons, houses, papers and effects against unreasonable searches and seizures.

Maryland law, and the Charles County Sheriff's Office, prohibits motorcycle profiling. Specifically, officers are prohibited from the arbitrary use of the fact that an individual rides a motorcycle or wears motorcycle-related clothing or paraphernalia as a factor in deciding to stop, question, take enforcement action, arrest, or search the individual or vehicle.

**1-134.2 POLICING IMPARTIALITY**

All law enforcement actions will be based on a standard of reasonable suspicion or probable cause in accordance with the Fourth Amendment of the U.S. Constitution. Officers, in taking enforcement action, should rely on their training, experience, knowledge, specific facts and circumstances. Officers must be able to articulate specific facts and circumstances that support reasonable suspicion or probable cause for all enforcement actions, including but not limited to traffic stops, arrests, non-consensual searches, and property seizures. Except as provided below, officers shall not consider race / ethnicity in establishing either reasonable suspicion or probable cause.

Officers may take into account the reported race or ethnicity of a specific suspect or suspects based on trustworthy, locally relevant information that links a person or persons of a specific race / ethnicity to a particular unlawful incident(s). Race / ethnicity can never be used as the sole basis for probable cause or reasonable suspicion. Except as provided above, race / ethnicity shall not be a motivating factor in making law enforcement decisions.

**1-134.3 PREVENTING PERCEPTIONS OF BIASED POLICING**

In an effort to prevent inappropriate perceptions of biased law enforcement, each officer shall make every effort to do the following when conducting pedestrian and vehicle stops:

- be courteous and professional;



**Administrative and Operational Manual**

**September 12, 2022**

- introduce himself to the citizen (providing name and Agency affiliation), and state the reason for the stop as soon as practical, unless providing this information will compromise officer or public safety;
- ensure the detention is no longer than necessary to take appropriate action for the known or suspected offense, and the citizen understands the purpose of any reasonable delays;
- answer any questions the citizen may have, including explaining options for traffic citation disposition, if relevant;
- provide his name and identification number when requested, in writing or on a business card; and
- offer an explanation and/or an apology if the reasonable suspicion was unfounded (e.g., after an investigatory stop).

Personnel of this Agency found to be engaging in a pattern of bias based profiling will be subject to counseling, remedial training and/or disciplinary measures, up to and including termination. Supervisors shall ensure all personnel in their command are familiar with the content of this policy and are operating in compliance with it.

To aid personnel in understanding bias based profiling issues and to facilitate compliance with Agency policies, the Training Division will ensure training pertaining to bias based profiling and its related legal issues is provided to all recruit training classes and on an annual basis for all personnel.

**1-135 DUTY TO GIVE A STATEMENT**

During the course of any official investigation by the Agency, all members shall be required to give a full, complete and truthful statement when requested.

**1-136 PERFORMANCE OF DUTY**

When an employee of this Agency becomes aware of facts or circumstances that indicate some type of action is required by the Agency, that employee will not disregard or dismiss the event, but will take action as would be required by the nature of their assignment.

Employees have a responsibility to take appropriate action in circumstances that involve fellow employees or other public safety / criminal justice associates (such as members of a task force or officers from other agencies) whose actions are criminal, unconstitutional or will harm the reputation of the Agency or law enforcement profession as a whole.

When encountering unreasonable actions of employees or public safety / criminal justice associates that could result in injury, death, or violations of constitutional or civil rights, intervention must be immediate when practical and safe.

All such incidents shall be reported to a supervisor as soon as possible.

At all times employees will be attentive and responsive to citizens who seek information, assistance or desire to file a complaint. Problems and experiences arising from confronting persons entrusted with providing public safety can be uncomfortable and diverse. Policies and procedures cannot always dictate every possible action on how Agency personnel should proceed. Consequently, all personnel are expected to possess and maintain a practical understanding of their obligations as public servants and perform accordingly.

**1-137 DUTY TO RENDER MEDICAL AID**



Administrative and Operational Manual

September 12, 2022

Following any law enforcement action where injuries are sustained due to that action and medical aid is required, employees shall render appropriate medical aid as soon as practical. If obvious severe injuries have occurred, medical distress is apparent or an individual is unconscious, an employee shall activate EMS by contacting Communications or calling 9-1-1. When transporting individuals involved in contentious police actions or following use of force incidents, consideration should be given to utilizing police personnel not directly involved in the action, if feasible.

**1-138 NOTIFICATION TO THE STATE'S ATTORNEY'S OFFICE**

The Charles County State's Attorney's Office has primary responsibility for all criminal proceedings that occur in Charles County.

Any time a police action brings about the potential for criminal charges against an officer, the Charles County State's Attorney's Office will be notified and be given the opportunity to review the facts of the case. The Agency will confer with the Charles County State's Attorney's Office and ensure they receive all necessary information allowed by law in situations where police action could result in criminal proceedings.

**1-139 VIOLATION OF FEDERAL, STATE AND LOCAL LAWS / ORDINANCES**

The violation of any federal, state or local law and/or ordinance shall be considered conduct not consistent with employment by the Charles County Sheriff's Office and will subject the employee to disciplinary action which may result in termination of employment.

**1-141 PROMOTIONAL EXAMINATION PROCESS SECURITY**

The written and oral examinations are major parts of the promotional process. It is essential to ensure the security of the process and fairness to every candidate. Therefore, applicants shall not disclose any aspect of the written or oral examinations to any other person(s). Prior to administration of any written or oral examination, applicants must affix their signatures to the Examination Security Order.

**1-142 TAMPERING WITH POSTED MATERIAL**

No member of this Agency shall alter, deface, destroy, or remove any official memorandum, notice, or written material that has been duly posted within any Agency facility. Nothing in this policy will prevent the orderly removal, by commanders, of out-of-date or obsolete materials.

**1-143 SMOKING**

In accordance with the Code of Maryland Regulations 09.12.23, the following restrictions shall apply:

- Burning of tobacco products (smoking) is prohibited in all Agency facilities, including Agency-owned vehicles and vessels. This prohibition is to include all employees and visitors.
- Approved outdoor smoking areas will be designated for each Agency facility.
- Employees and visitors in violation may be subject to formal criminal or civil sanctions dependent upon the laws concerning smoking in public places.

Additionally, the Agency also prohibits the use of electronic smoking / vapor devices (e-cigs) in any and all areas where the use of tobacco products is also prohibited.



**Administrative and Operational Manual**

**September 12, 2022**

## **1-200 COMMUNITY RELATIONS**

A citizen's encounter with the police can be a frightening or emotionally painful experience, and under these circumstances the risk of misunderstanding is very great. Contacts between employees and citizens may occur in emotionally-charged situations which can seriously impact the situation.

Employees should strive to develop a climate within the community supportive of collective police-community efforts toward common goals of peace, safety, and security.

### **1-200.1 INDIVIDUAL DIGNITY**

As all citizens are subject to the law, they have a right to dignified treatment. All employees are responsible for protecting this right.

### **1-200.2 THE ROLE OF EMPLOYEES**

Employees are the link between the Agency and the community; as such, they may strengthen or destroy police-community relationships which may have taken considerable effort to develop. Because the conduct of each employee reflects on the Agency as a whole, the burden of achieving the Agency's community relations objectives are shared by all personnel. Employees shall attempt to make each contact between themselves and the public one which inspires confidence and demonstrates professionalism.

Employees should be open to comments and suggestions from the community. If during any contact with a citizen, an employee receives relevant information about community attitudes, concerns, or opinions that the Sheriff or other command staff should be made aware of, that employee will forward the information to the Commander, Community Services Section, and the District Commander for the affected district through the chain of command.

## **1-201 INTERPERSONAL COMMUNICATIONS**

All employees should be aware of the stress generated by most contacts between those outside a police organization and those who are employed by the organization. Police personnel have to contend with the communications barrier developed because of the perception that police personnel are somehow different from other members of the society. It is incumbent upon all employees of this Agency to minimize and break down those barriers to effective communications between the Sheriff's Office and the community in general.

One of the ways to more effective communications is that of treatment of individuals. All persons should be treated with dignity and respect. This is not to say that in emergency situations lawful orders and commands cannot be issued. On the contrary, it is the responsibility of all employees to take a firm lead in times of crisis. Employees of the Sheriff are trained and equipped for just this purpose. However, the manner in which an order or request is issued can initially determine the probability of a successful outcome.

## **1-202 EQUITY OF TREATMENT**

All members of the society are entitled to equitable treatment. This is to say, that all segments of the community will receive the same level of service and the same level of respectful treatment. The partnership of police and their community is dependent upon the trust and sense of fair treatment experienced by all members of the society. Without this trust, the likelihood of successful police work is in jeopardy.





Administrative and Operational Manual

September 12, 2022

## 1-203 OPENNESS OF OPERATIONS

The Charles County Sheriff's Office conducts its affairs in a professional manner, holding its personnel to high standards of ethical performance. Therefore, all matters which are not confidential because of investigative necessity and are not held confidential because of law or regulation, will be made available for public disclosure. This Agency's personnel will cooperate with news media representatives and other persons representing the public interest in the Agency's operations. These persons will be assisted in gathering facts and information to the extent that it does not adversely affect the operation of the Agency.

## 1-204 COMMUNITY PARTICIPATION BY EMPLOYEES

Employees are encouraged to participate in civic activities and programs within the County. Active participation in divergent civic, youth, and social activities reduces police-related stress and provides a vehicle for employees to be seen as involved community members in other than a professional or controversial environment.

## 1-300 MEDIA RELATIONS

At the core of a free society is the ability of the general public to acquire and evaluate information concerning the events and activities of all aspects of that society. In this regard, the existence of a free media is essential. All elements of the media must be allowed and encouraged to gather and report every aspect of the operation of the society. The operation of this Agency is one of those aspects.

It is to the advantage of the Agency and to the benefit of the citizens of Charles County to encourage complete and thorough media coverage of the activities and operations of the Charles County Sheriff's Office. The reporting of these activities and operations provides an important means of establishing the channels of communications with the public, necessary for this Agency to properly perform its role in the society. In some cases it may be necessary to withhold certain information from public disclosure. This will be permitted only to the degree that it is required by law, necessary to further an investigative purpose or to protect a witness or victim.

### 1-300.1 RELEASE OF INFORMATION

If in the normal operation of police activities an unusual and newsworthy event should occur which causes great public concern or media interest, the shift commander, or in his absence, the on-scene supervisor, will contact the Media Relations Office as soon as practical. In addition, a Commanders' Information Report will be completed in accordance to Section 4-115 of the AOM.

Examples of incidents which shall require an immediate notification to the MRO include, but are not limited to:

- Any shooting involving a police officer;
- Any incident which requires a lockdown or "shelter in place" of any private or public school, public building, or any area / neighborhood affected by a police activity;
- Homicides, suspicious deaths, accidental deaths;
- Serious injury or death of a police officer or Agency employee;
- Serious injury or death of a citizen resulting from a police action;
- Incidents involving prominent or famous persons;
- Critical or fatal motor vehicle collisions;
- Any incident requiring the issuance of an Amber, Silver, or Yellow alert, or the activation of a Project Lifesaver response;
- Large scale arrests or incidents which are likely to attract media attention.



Administrative and Operational Manual

September 12, 2022

---

### 1-300.1.1 INCIDENTS INVOLVING FATALITIES OR SERIOUS BODILY INJURY

In cases where an officer is seriously injured or killed as a result of an accident or assault, or is involved in a law enforcement action where another person is seriously injured or killed:

- The Media Relations Specialist or designee will act as the main point of contact for all communication with the media.
- Information surrounding the incident will only be released by the Media Relations Specialist or designee.
- The Media Relations Office will coordinate the release of information with all other involved agencies as appropriate, such as when multiple agencies are involved.
- As a matter of mutual courtesy, the Agency will confer with the State's Attorney's Office prior to the release of any public information.

The Agency shall release only the officer's last name, rank, tenure, and duty assignment to the public within the first 48 hours of the critical incident. In determining the timing of the release of the officer's information, the Agency will take into account the circumstances involved in the critical incident and the safety of the officer. Where practical, the Agency will also notify the officer and the designated FOP representative about the release of information. Notwithstanding the above, where the officer is injured or killed in the line of duty, the Agency would have full discretion in regards to releasing additional information about the officer.

### 1-300.2 MEDIA ACCESS TO SCENES

A command officer, Lieutenant or above, in charge of a scene may permit news media access inside police lines for news gathering purposes. The officer should evaluate the danger to the media, the possible contamination of the scene, the need to protect sensitive evidence and information and any interference which might occur with an ongoing investigation or incident. If these considerations can be resolved, the officer may permit controlled access to the degree possible under the instant circumstances. The scope of the allowed media access should be clearly defined for all news media persons allowed across police lines. Those persons shall then be continually escorted or limited to a particular area which can be controlled by Agency personnel. The identity of each media person should be known or should be proven by media credentials before entry is allowed. Freelance journalists, without media credentials, will be treated as private citizens. News media persons will be denied access, or removed from a previously granted access, any time their presence jeopardizes a legitimate police purpose. In making decisions concerning the access of media persons at scenes, officers in charge should be aware that these persons have the same statutory responsibilities and are subject to the same laws and rules as are any other citizens. Media have the right to access any property open to the public in general.

Journalists and other non-essential persons will not be allowed access to private property or privileged information under law enforcement control. Scenes which would be normally closed except for law enforcement purposes will be protected from access by all persons not needed to officially contend with the incident.

### 1-300.3 POLICE REQUEST TO WITHHOLD INFORMATION

News gathering representatives may photograph or report anything they observe when they are legally present at an incident scene. Where publication of such coverage would interfere with an official investigation or place a victim, suspect, or others in jeopardy, the withholding of publication is dependent upon a cooperative media, not upon censorship by the police Agency. Under such circumstances, officers should advise the media representatives or their superior of the possible consequences of publication. However, officers may not interfere with news gathering activities as long as the performance of that action remains lawful.

Officers may not seize the lawful work product (film, photos, notes, recordings, etc.) or equipment from a reporter or photographer in an effort to prevent the release of the information or to further a criminal investigation.



Administrative and Operational Manual

September 12, 2022

## 1-300.4 INDIVIDUAL PRESS STATEMENTS

No employee of the Charles County Sheriff's Office may make a statement to the media concerning the operations or administration of the Agency; and no statement may be made concerning the employee's personal role in any operation or administrative activity of the Agency without the permission of the officer in charge of a scene or the employee's division commander. This policy is made to prevent individual employees from mistakenly misrepresenting the Agency without first having the benefit of all facts and information which may affect such a representation. In this way, statements made by Agency personnel will more likely accurately represent Agency policies and provide the media's representatives with more complete information. It is better to do it right the first time than to have to try to correct erroneous or harmful information which has already been made generally public.

If there is a known possibility of civil action against an employee or the Agency concerning an event, statements will not be made without the authorization of the Sheriff or an Assistant Sheriff. Individual employees will refrain from making statements concerning their personal opinion of the truthfulness of any statements made by any victim or witness associated with an investigation.

## 1-300.5 PRESS RELEASES

Press releases will be made concerning the following:

- felony criminal investigations;
- serious or unusual misdemeanor criminal investigations;
- all felony arrests and serious misdemeanor arrests;
- all motor vehicle crashes with injuries;
- all fatal motor vehicle crashes;
- all serious hit and run crashes;
- any motor vehicle crash of unusual interest;
- all arrests for driving while intoxicated or under the influence of drugs and/or alcohol;
- arrests or citations issued for alcohol violations (names of juveniles to be withheld);
- incidents occurring within public schools (names of juveniles to be withheld); and
- vehicle thefts, including make / model / year and the registration number of the stolen vehicle.

In motor vehicle cases, arrest and citation information (except for the names of juveniles) should be included. Information to be excluded from press releases and held confidential shall include:

- the names of witnesses or victims of crimes;
- the names of accused child abusers when identifying the accused would likely identify the victim(s);
- the names of deceased persons prior to notification of next of kin;
- the names of juveniles (except those charged as adults);
- criminal history information;
- information concerning admissions or confessions of accused persons;
- specific dollar amounts of cash or property involved (except that an indication of whether the amount is over or under \$1000); and
- any information, which in the opinion of the investigating officer, could impede the ongoing criminal investigation or prosecution.

If a Crime Information Report has been completed in regards to an incident, and the report contains the necessary information for a Press Release, a separate Press Release does not need to be completed. The completing officer will check the box at the bottom of the report indicating the MRO will complete a press release. In cases where the release of information contained on a Crime Information Report may hinder an investigation, the box indicating "No press release" should be marked. Any further inquiries will be made to the investigating officer through the MRO.



Administrative and Operational Manual

September 12, 2022

### 1-300.6 PRESS RELEASE PROCEDURE

Press releases completed by the investigating officer will be submitted to a supervisor prior to the end of the investigating officer's tour of duty. Press releases will be forwarded to the Media Relations Office for review and/or any needed revision. Copies of only those press releases approved by a supervisor will be maintained at the La Plata District Station's front desk. The media will have free access to press releases. When media representatives request further information regarding a press release or incident, they will be referred to the appropriate commander or the Media Relations Office. Members of the media should not be referred to the investigating officer for further information. Employees are reminded only information which is contained in the press release may be communicated to the public.

Individual employees will not engage in either on- or off-the-record conversations with members of the media regarding Agency matters and/or investigations without prior command level approval. The Agency MRO will be made aware of any approved officer contact with the media. Further, employees will refrain from offering personal opinions on any aspect of an investigation. Any employee violating this policy may be subject to disciplinary action.

### 1-300.7 REQUESTS BY CITIZENS FOR RESTRICTED RELEASE OF INFORMATION

Whenever a citizen requests that information concerning a particular incident not be released to the media, employees shall explain that police reports are generally considered public information, and therefore, accessible to the media. Employees may indicate on a report a press release was not completed for the incident; however, the media will make the decision whether or not to publish publicly available information.

### 1-305 PRIVATE CITIZENS PHOTOGRAPHING OR VIDEOTAPING POLICE OFFICERS IN PUBLIC

It is increasingly common for uninvolved bystanders at the scene of police activity to photograph and/or video record the actions of police officers and their conduct. Members of the Charles County Sheriff's Office should simply assume that, at any time, a member of the public is likely to be observing, and perhaps even photographing or video recording, their activities.

As a result, members must understand that any bystander has an absolute right to photograph and/or video record the enforcement actions of any police officer so long as the bystander's actions do not:

- Place the safety of the bystander, or of any police officer(s), witness(es), victim(s), or suspect(s), in jeopardy;
- Hinder the execution or performance of an officer's official duties;
- Interfere with the enforcement of violations of any section of law, ordinance, code, or criminal or traffic article;
- Involve an incursion into any crime scene, private property, or other location under lawful police control and/or not normally accessible to the general public;
- Threaten, by words or actions, other persons; or
- Attempt to incite an immediate breach of the peace or incite others to commit a violation of the law.

The acts of observing, photographing, and/or making a video recording of any police activity that occurs in a public setting are not criminal offenses. It does not provide any justification whatsoever for any member of the Charles County Sheriff's Office, without consent of the owner or a search and seizure warrant or other appropriate court order, to seize or otherwise inspect the contents of a person's camera or video recording device.

In addition to already existing legal precedent, §2-109 of the Criminal Procedure Article, effective July 1, 2022, states police officers "may not prohibit or prevent a citizen from recording the police officer's actions if the citizen



Administrative and Operational Manual

September 12, 2022

is otherwise acting lawfully and safely.”

Absent any of the above six criteria, upon discovery that a bystander is observing, photographing, or video recording the conduct of police activity:

- Do not impede or prevent the bystander's ability to continue to do so, based solely on your discovery of his/her presence.
- Do not seize or otherwise demand to take possession of any camera or video recording device the bystander may possess, based solely on your discovery of his/her presence.
- Do not demand to review, manipulate, or erase any images or video recording captured by the bystander, based solely on your discovery of his/her presence.

For investigative purposes, be mindful of the potential that the bystander may witness, or capture images/video of events considered later to be material evidence. Nothing in this policy should be construed by members of the Charles County Sheriff's Office as an elimination of their ability to seek out, collect, or otherwise gather evidence in the course of a criminal investigation.

If an officer has probable cause to believe that a bystander is in possession of any still photographs, video recordings, and/or audio/sound recordings that could reasonably be considered evidence related to a crime and/or the identification of a person involved in a crime, a supervisor must be contacted. Unless exigent circumstances exist, only a supervisor may attempt to obtain control of a camera or video recording device without a warrant or consent.

### 1-305.1 SUPERVISOR RESPONSIBILITY

Supervisors should respond to any scene where members under their supervision believe there is a bystander who is observing, photographing, and/or video recording their conduct and:

- the bystander's actions are approaching the level of a criminal offense;
- the bystander's actions are approaching a risk to the safety of officers or others;
- the bystander may have captured video or photographs that would be material evidence of a crime or reportable use of force; or
- the supervisor's presence is requested.

The supervisor shall ensure adequate police attention remains focused on whatever situation originally required a police response.

The supervisor shall not allow subordinates under their supervision to become distracted from their professional duties if it is suspected that deliberate provocation is occurring.

If the bystander's actions are approaching the level of a criminal offense, the supervisor shall inform the bystander that his/her actions may, if continued, rise to the level of a criminal offense, and could subject him/her to arrest. If the bystander's presence is approaching a risk to the safety of officers or others, the supervisor shall direct the bystander to a safer location which still allows the bystander to record the police activity.

The supervisor shall recover, or cause to be recovered, any camera or video recording device that contains material evidence of a crime or reportable use of force:

- Through the voluntary consent of the individual in possession of the item.
- Through execution of a Search and Seizure Warrant.
- Through some valid exception to the warrant requirement.

Supervisors should provide guidance and assistance to members on those occasions when an application for a Search and Seizure Warrant is made for a camera, video recording device, etc., believed to contain evidence



Administrative and Operational Manual

September 12, 2022

related to a criminal investigation.

### **1-305.2 SEIZING A BYSTANDER'S VIDEO RECORDING DEVICE FOR EVIDENTIARY PURPOSES**

If a bystander is believed to possess any material that is, or could reasonably be considered to be, evidence related to a crime and/or the identification of a person involved in a crime, an officer may make a request of the bystander that he/she voluntarily surrender his camera, video recording device, etc., into police custody. The officer should also seek consent from the bystander to access the device to retrieve and copy the images/video relevant to the incident. In the absence of consent, a search warrant is required to search the contents of the device.

When an officer obtains possession of the device, the officer shall refer to Section 4-540 of this Manual for instructions on how to safely take custody of the device.

If there is probable cause to believe that evidence exists on an individual's device, and there is a reasonable likelihood that evidence will be tampered with or destroyed before a warrant can be obtained, a supervisor may temporarily seize the device for safekeeping / preservation of the evidence while the appropriate application(s) for Search and Seizure Warrant(s) are made. In such cases, the officer shall apply for and execute the Search and Seizure Warrant(s) by submitting the device to the DFU.

## **1-400 PUBLIC INFORMATION**

It is the policy of this Agency to comply with all legitimate requests for information concerning its actions and operations. Because of the technical nature of some requests, all of those requests, which are not specifically covered elsewhere in this Manual, will be referred to the Sheriff or his designee.

### **1-400.1 FEATURE ARTICLES OR PROGRAM OPERATIONS**

Requests for Agency participation in feature articles and programs and the photographing of police facilities will be limited to the scope of approval obtained by the media company from the Sheriff. Employees participating in the preparation of such articles or programs should ascertain the scope of the approval and should be careful not to exceed those limits. In any event, employees should exercise care and discretion to avoid making statements or conveying information which, if later quoted, would create a misunderstanding or compromise the effectiveness of the Agency.

### **1-400.2 EMPLOYEES' RESPONSIBILITY TO RESPOND TO REQUESTS**

It is not uncommon for individual employees to be contacted by the public or by news-gathering organizations seeking specific information. Employees should appropriately answer questions put to them or refer the requestor to the appropriate commander for the answer. When a request is made for information about a police matter, employees should decide whether the requestor is a proper person to receive the information. Generally, employees should be open in their dealings with the public and, unless there is reason to the contrary, should supply the requested information. Employees should be careful to avoid representing their opinions as fact, compromising an investigation, or divulging protected criminal history or victim information.

## **1-500 LABOR RELATIONS**

It shall be the policy of the Charles County Sheriff's Office to be an impartial observer in labor disputes. The Agency's only role is that of ensuring order and the obedience of rule of law. When members of this Agency are called to or otherwise have the occasion to be at the scene of a labor dispute, they will conduct their activities to prevent violations of law and to protect all parties from lawless acts.



Administrative and Operational Manual

September 12, 2022

Officers will take action to see that free access is allowed to all persons using public roads, sidewalks, and parking lots. Those who seek to block or disrupt such access will be required to obey the law or face arrest.

Officers are not normally deployed at scenes of labor disputes. However, if conditions exist which require the deployment of Agency personnel in such cases, a command officer will assume control of such deployment. The on-duty district / shift commander is normally the responsible command officer.

## CHAPTER 2 – AGENCY STRUCTURE, ORGANIZATION, AND RESPONSIBILITIES

### 2-100 AGENCY ORGANIZATION

The Charles County Sheriff's Office (CCSO) is established by the Constitution of the State of Maryland (Article IV, § 44). The Office is further defined by Article 87, the Courts and Judicial Proceedings Article, and other areas of the Annotated Code of Maryland and the Public Local Laws of Charles County. Sheriffs are constitutional officers whose powers and duties are not expressly enumerated in the Constitution. Rather, those powers and duties are prescribed by the common law as modified by the acts of the legislature (Soper v. Montgomery County, 294 Md. 331, 449 A.2d 1158 [1982]).

The CCSO has three major responsibilities, which can be loosely defined as providing police services, court services, and correctional services. This chapter of the AOM describes how the Agency is organized to deal with those responsibilities. It also provides Agency personnel with the knowledge of how their particular unit of the organization is to fulfill its role in meeting those responsibilities.

### 2-101 AGENCY DEFINITIONS

**Agency** - is the Charles County Sheriff's Office.

**Agency Owned** - includes property and vehicles that are owned, leased, rented, or acquired in any manner by the Agency or Charles County Government, State of Maryland, U.S. Government, or any other entity for the use of the Charles County Sheriff's Office or the Charles County Government.

**Agency Segment** - is one of three specific classification groups into which all employees are divided: Sworn Officer, Correctional Officer, or Civilian Employee.

**Area of Responsibility** - is a specific geographic territory, group of physical assets, group of tasks, or combination of all of these. For example, the area of responsibility for a patrol officer might be a sector, combination of sectors, or a portion of one or more sectors. The area of responsibility for the Deputy Director, Records Management Section might be all the tasks assigned to Records Management Section, the physical office space and the equipment assigned to the section. It is incumbent upon each employee to manage his area of responsibility in the most efficient and effective manner possible in order to achieve Agency goals.

**Beat** - is a geographical subdivision of a sector.

**Component** - is any organization element. Each organizational component is under the direct command of only one supervisor.

**County** - is Charles County, Maryland.

**Cruiser** - is a four-wheeled Agency vehicle that is not a truck or a van. When occupied by an on-duty officer(s) it may also be called a unit, mobile unit, or car to conform to common speech. Cruiser does not imply the status or rank of the operator or occupants.



Administrative and Operational Manual

September 12, 2022

**Detail** - is a subunit of a division, section, or unit, whose personnel are assigned to a specialized task.

**District** - is a geographical division composed of one or more sectors.

**District Station** - is a facility housing district employees and equipment.

**Division** - is one of the major components of the Agency, commanded / managed by a Captain or civilian director.

**Fitness for Duty Examination** - is an examination of a current employee to determine whether the employee is physically or psychologically able to perform the essential functions of the job. The type of examination is dependent upon the circumstances leading to the fitness-for-duty examination request.

**Function** - is a group of duties assigned to and performed by an employee or body of employees. Function may also be used to indicate the employee or employees.

**Manual** - is the Administrative and Operational Manual (AOM) of the Charles County Sheriff's Office.

**Patrol Operations** - those Patrol Division personnel responsible to one of the two division commanders, and including shift commanders.

**Section** - is a subunit of a division.

**Sector** - is a geographical subdivision of a district.

**Seniority** - is established first by rank or position within the organizational structure, and second by the consecutive time served in the current rank or position. Where conflicts occur because of identical service or dates of appointment, the employee with the lower I.D. number is deemed to be senior.

In situations requiring decision or control when employees are of equal rank or position, the senior will make the decision or exercise control unless otherwise directed by a higher ranking employee. However, operational law enforcement or correctional activities, of a sworn or correctional officer respectively, shall only be directed by senior employees as permitted by law. For example, a civilian would not direct an arrest situation, but may direct the marshaling of supplies and equipment for the situation, if that were the senior civilian employee's area of responsibility.

Joint operations of sworn and corrections employees shall be directed by a senior employee having area of responsibility. For example, if sworn officers are helping to quell a disturbance within a corrections facility, the operation shall be the responsibility of the senior corrections employee. Likewise, if corrections employees are used to assist patrol officers during a crisis situation, the senior sworn employee having responsibility shall be in charge. Nothing in this section is intended to abridge any power of the Sheriff to direct and control the entire Agency's activities.

**Span of Control** - is the number of subordinates under the immediate and functional control of a single supervisor. An employee in charge, holding the rank of Sergeant or the equivalent first-line supervisory position, is limited to normal full-time supervision of a maximum of 15 employees.

**Shift** - is the personnel grouped together for scheduling purposes.

**Squad** - is a unit composed of a group of officers performing related tasks.

**Unit** - is a subdivision of a section.

**Watch** - is a tour of duty covering an established schedule of hours. In units which utilize three daily watches, Watch I is the midnight watch, Watch II is the day work watch, and Watch III is the evening watch, with actual work





## Administrative and Operational Manual

September 12, 2022

hours designated appropriately.

## 2-102 ACRONYMS

Acronyms allow for less wordy and more efficient communications within the Agency. The following listed acronyms are used throughout this Manual and should also be employed in other in-house documents and correspondence. Acronyms should not be used in documents and correspondence designed for use outside the Agency because their meanings may not be clear in that context.

### 2-102.1 ACRONYMS LIST

<b>AHB</b>	- Administrative Hearing Board
<b>AOM</b>	- Administrative and Operational Manual
<b>AWOL</b>	- Absent from duty position Without Leave Approval
<b>CAD</b>	- Computer Assisted Dispatch
<b>CALEA</b>	- Commission on Accreditation for Law Enforcement Agencies
<b>CCDC</b>	- Charles County Detention Center
<b>CCSO</b>	- Charles County Sheriff's Office
<b>CDS</b>	- Controlled Dangerous Substances
<b>CHRI</b>	- Criminal History Record Information
<b>CID</b>	- Criminal Investigations Division
<b>CIM</b>	- Criminal Investigations Manual
<b>CIR</b>	- Commanders' Information Report
<b>CO</b>	- Commanding Officer
<b>COG</b>	- Metropolitan Washington Council of Governments
<b>COPS</b>	- Community Oriented Police Services
<b>CRMC</b>	- University of Maryland Charles Regional Medical Center (La Plata)
<b>CTAU</b>	- Maryland State Police, Chemical Test for Alcohol Unit
<b>DARE</b>	- Drug Abuse Resistance Education
<b>DER</b>	- Department of Environmental Resources
<b>DO</b>	- Duty Officer
<b>DUI</b>	- Driving Under the Influence
<b>DWI</b>	- Driving While Intoxicated
<b>EST</b>	- Emergency Services Team
<b>EEO</b>	- Equal Employment Opportunity
<b>FBI</b>	- Federal Bureau of Investigation
<b>FOP</b>	- Fraternal Order of Police, Lodge #24
<b>FT</b>	- Full Time (when used with reference to an employee)
<b>FTRH</b>	- Full Time Reduced Hours (when used with reference to an employee)
<b>FTO</b>	- Field Training Officer
<b>HNT</b>	- Hostage Negotiations Team
<b>IA</b>	- Internal Affairs Section
<b>ITD</b>	- Information Technology Division
<b>JOR</b>	- Juvenile Offense Report
<b>K-9</b>	- Canine
<b>LEOBR</b>	- Law Enforcement Officers' Bill of Rights
<b>LWOP</b>	- Leave Without Pay
<b>ACRS</b>	- Automated Crash Reporting System
<b>MAB</b>	- Medical Advisory Board
<b>MAFIS</b>	- Maryland Automated Fingerprint Identification System
<b>METERS</b>	- Maryland Electronic Telecommunications Enforcement Resource System
<b>MO</b>	- Modus Operandi
<b>MNCPPC</b>	- Maryland National Capital Park and Planning Commission
<b>MPDC</b>	- Metropolitan Police Department, Washington, DC



Administrative and Operational Manual

September 12, 2022

- MPTSC** - Maryland Police Training and Standards Commission
- MRO** - Media Relations Officer
- MSDS** - Material Safety Data Sheet
- MSP** - Maryland State Police
- NCIC** - National Crime Information Center
- NCO** - Non-Commissioned Officer
- OIC** - Officer-In-Charge
- PCO** - Police Communications Officer
- RAFIS** - Regional Automated Fingerprint Identification System
- SAO** - Office of the State's Attorney for Charles County
- SMP** - Agency Strategic Management Program
- SOP** - Standard Operating Procedures
- T/A** - "Trading As," common reference for a business
- TDY** - Temporary Duty Assignment
- UMPD** - University of Maryland Police Department
- US** - United States of America
- USPP** - United States Park Police
- UUV** - Unauthorized Use of a (Motor) Vehicle
- VIN** - Vehicle Identification Number

## 2-103 RANK PRECEDENCE OF SWORN AND CORRECTIONAL PERSONNEL

The order of rank precedence of sworn personnel of the CCSO, in descending order, from that of most, to that of least authority is:

- Sheriff
- Lieutenant Colonel (LTCOL) / Chief of Staff
- Major (MAJ)
- Captain (CPT)
- Lieutenant (LT)
- Master Sergeant (MSgt)
- Sergeant (SGT)
- Master Corporal (MCpl)
- Corporal (CPL)
- Police Officer First Class (PFC)
- Police Officer II (PO2)
- Police Officer I (PO1)

Correctional Personnel:

- Sheriff
- Lieutenant Colonel (LTCOL) / Chief of Staff
- Major (MAJ)
- Captain (CPT) or Director (DIR)
- Deputy Director (DD)
- Corrections Captain (CPT)
- Lieutenant (LT)
- Master Sergeant (MSgt)
- Sergeant (SGT)
- Master Corporal (MCpl)
- Corporal (CPL)
- Correctional Officer First Class (CFC)
- Correctional Officer II (COII)
- Correctional Officer I (COI)



Administrative and Operational Manual

September 12, 2022

The abbreviation of rank listed above for each position is appropriate for all official documents and correspondence. Personnel of this Agency shall ensure that these abbreviations are used when it is appropriate to use an abbreviation of rank.

## 2-104 PERSONNEL DEFINITIONS

**Chief of Staff** - a civilian position within Charles County Sheriff's Office equivalent to the sworn Lieutenant Colonel position. It is the highest responsible senior administrative and supervisory authority of all employees of the Agency.

**Commanding Officer** - any commissioned officer in charge of an Agency component.

**Command Staff** - includes the Sheriff, Chief of Staff, Assistant Sheriffs all other sworn officers the rank of Lieutenant, and above and Deputy Directors.

**Commissioned Officer** - an officer holding the rank of Lieutenant or higher.

**Commissioner** - refers to a commissioner of the District Court of Maryland. Commissioners have statutory authorization to conduct initial appearance hearings for persons charged as adults with crimes in order to evaluate the propriety of their pretrial release.

**Correctional Officer** - a correctional officer, as defined by the Maryland Police Training and Standards Commission, who is an employee of the Charles County Sheriff's Office.

**Director** - a civilian employee assigned to the Executive Staff of the Agency. This is not a command position as defined for sworn and correctional personnel. The directors may be responsible for staff components at the division level that provide support to operational components performing the mission of the Agency.

**Deputy Director** - a civilian employee who is responsible for a component of the Agency. A deputy director has supervisory responsibilities for all personnel assigned to his command. Deputy directors may supervise all functions of sworn personnel assigned to their command except those related to arrest.

**Division Commander** - an officer the rank of Captain who commands a division and is directly responsible to an Assistant Sheriff.

**Employee** - a sworn police officer, correctional officer, sworn court security officer, police communications officer or civilian, appointed or assigned to the Agency in a permanent or temporary paid position.

**Executive Staff** - comprised of the Sheriff, Chief of Staff, Assistant Sheriffs, all sworn Captains, civilian Directors and the Agency General Counsel.

**Manager** - a civilian employee in charge of a certain group of tasks or a group of employees within a section / unit. A manager is directly responsible to a section commander or Deputy Director.

**Master Corporal** - an officer holding the rank of Corporal with the appointed title of Master Corporal. This title may be bestowed by the Sheriff if a Corporal meets the minimum years of service requirements and passes a nomination and review process.

**Master Sergeant** - an officer holding the rank of Sergeant with the appointed title of Master Sergeant. This title may be bestowed by the Sheriff if a Sergeant meets the minimum years of service requirements and passes a nomination and review process.

**Non-Commissioned Officer** - an officer holding the rank of Sergeant or below.



Administrative and Operational Manual

September 12, 2022

**Personnel** - Agency employees.

**Police Communications Officer** - an employee of the Charles County Sheriff's Office who is assigned the task of radio communications and the associated responsibilities. These employees do not have arrest or police powers and are not sworn law enforcement officers.

**Sector / District Supervisor** - a supervisor of patrol officers assigned to a sector.

**Shift Commander** - a sworn Lieutenant who is responsible for managing the patrol operations of a particular shift in the Northern or Southern Patrol Division, or the midnight shift.

**Superior Officer** - an employee holding a higher rank or position according to the established rank precedence.

**Supervisor** - an employee assigned to positions authorizing the exercise of immediate supervision over other employees, including:

- employees assigned in an acting or TDY capacity; and/or
- specific employees granted a supervisory role for purposes not otherwise contrary to specific policy; e.g., a Corporal granted supervisory authorization by his Sergeant; and/or
- specified employees exercising direct supervision over a component during the absence of the supervisor or commander.

Supervisors are responsible for:

- the conduct and activities of all subordinates; and
- the actions of subordinates upon whom they have been granted supervisory authorization.

**Sworn Officer** - any sworn police officer or sworn court security officer, as defined by the Maryland Police Training and Standards Commission, of the Charles County Sheriff's Office.

## 2-105 ORGANIZATIONAL TERMS OF REFERENCE

**Accountability** - is the responsibility of any employee to discharge his assigned duties or execute rights and privileges in a lawful, professional manner. Each employee is accountable to only one supervisor at any given time.

**Authority** - is the right to act or exact action by others; the power to decide and to require that decisions are acted upon.

**Chain of Command** - is the hierarchy of authority that extends from the top to the bottom of the organization. All communications, unless otherwise specifically directed, will follow the chain of command.

**Command** - is the authority and responsibility to direct and control subordinates in order to accomplish missions. It includes the authority to assign tasks, designate objectives and supervise their execution.

**Conflicting Orders** - is an order given contrary to prior instructions or directives (see also Chapter 1, Section 1-110).

**Designation of Authority (Designee)** - is the authority conferred upon supervisory employees and commanding officers to delegate responsibilities to officers and employees under their supervision or command. Unless otherwise prohibited, supervisory employees and commanding officers may utilize this authority at their discretion. Once such authority is delegated, the designee shall be accountable for its use.

**He** - In those cases where the writer uses the masculine pronoun in referring to Agency personnel in general, the



Administrative and Operational Manual

September 12, 2022

feminine pronoun is hereby specifically included.

**Lawful Order** - is any order issued by a superior employee, or relayed from a superior employee by an employee of the same or lesser rank, to any subordinate which is not in violation of any law, ordinance or any written directive. Employees will obey all lawful orders.

**Line Components** - are the elements of the Agency which directly perform the mission of the Agency.

**May** - is indicative of an action which is permissible.

**Shall / Will** - is indicative of an action which is mandatory.

**Staff Components** - are the components of the organization which do not directly perform the mission of the Agency. Staff components assist or provide support to operational components performing the mission of the Agency.

**Standard Operating Procedures** - are directives written at the division or section level, which contain procedures unique to the particular component. SOPs may restrict, but not enlarge, the authority contained in the AOM. They are issued on the authority of the division commander.

**Temporary Duty Assignment (TDY)** - is an assignment where an employee is transferred, on an interim basis, to an assignment different from his permanent assignment.

**Written Directives** - are written Agency documents which guide the performance or conduct of employees; e.g., AOM, SOPs.

## 2-106 24-HOUR STAFFING

The following components will provide 24-hour staffing. If necessary, supervisors will ensure staffing via changes in work schedules or assignments.

- Patrol Operations;
- Support Services Division: Communications;
- Corrections Division.

## 2-107 GENERAL DUTIES AND RESPONSIBILITIES OF COMMAND AND MANAGEMENT

In addition to specific duties and responsibilities particular to their Agency component responsibilities, commanding officers and civilian directors shall:

- ensure maintenance of a current SOP Manual (Upon development, a copy of the SOP Manual, and/or any new procedures inserted, will be transmitted to Planning & Accreditation);
- ensure a uniform standard of discipline;
- as directed by the Commander, Office of Professional Responsibility, assign and monitor disciplinary investigations; and
- periodically conduct staff meetings with employees under their supervision:
  - for the purpose of exchanging information and ideas at all levels of the component;
  - for the purpose, also, to identify problems and seek solutions; and the attendance and minutes of such



**Administrative and Operational Manual**

**September 12, 2022**

---

meetings will be recorded and maintained within the component for so long as they may be of value, but in no case for less than one year from the date of the meeting;

- provide for frequent inspection of the facilities, equipment and personnel within the component, and provide for prompt corrections of deficiencies discovered as a result of these inspections;
- ensure that all files and records are accurately maintained;
- ensure that all Agency property is properly maintained;
- assign personnel to most effectively meet the workload requirements;
- forward suggestions for revision of position descriptions to the Commander / Director, Administrative Services;
- account for the use of pool vehicles assigned to their component;
- control and direct subordinates through direct supervision and leadership;
- maintain such working hours as may be necessary in order to accomplish the duties and responsibilities associated with the supervision of their component;
- ensure the proper security, disbursement, and accountability of funds entrusted to their component;
- provide for a quarterly accounting of all component cash funds;
- maintain property storage locations within their component; provide liaison with the Commander, Property Management Section, to maintain an efficient property management system;
- ensure all employees under their command have access to the Administrative and Operational Manual (AOM) on the CCSO Intranet and that they review and sign for documents, tests, and other materials posted on Power DMS in a timely manner.
- maintain and monitor long distance telephone logs for telephones used by more than one employee;
- provide individual copies of work schedules for personnel who work rotating shifts;
- perform, at minimum, a bi-annual inspection of all property and equipment not personally assigned to employees;
- notify the Assistant Sheriffs, in writing, of transfers and long-term TDY assignments;
- conduct an annual review of all sworn positions in their component to determine whether they may be more effectively filled by civilian employees;
- review the monthly activity / statistical reports for components under their supervision; and
- conduct an annual review of the workload statistics on the components under their supervision, and forward a summary to the Assistant Sheriffs.

## **2-200 AGENCY ORGANIZATIONAL STRUCTURE**

The Charles County Sheriff's Office is divided into various components for the purpose of organizing duties and



**Administrative and Operational Manual**

**September 12, 2022**

---

responsibilities in a logical manner to provide the most efficient and effective means of achieving the goals of the Agency. Although each individual within the CCSO has the responsibility to help in the realization of all Agency goals, efforts in this regard would be fragmented and unlikely to succeed without some organizational plan in place. Therefore, the CCSO has been organized into various Agency components which have specifically defined responsibilities. These component responsibilities are in addition to the individual responsibilities assigned in job descriptions and elsewhere in this Manual.

Commanders and directors of components have the component responsibilities assigned specifically to them by this section. Personnel assigned to a component have the component responsibilities assigned generally to them. Some personnel may have specific component responsibilities assigned by their job description, a component SOP, or by an assignment of the commander or director.

Whenever a position is charged with a responsibility for the accomplishment of a particular task, the commensurate authority is conveyed to accomplish the responsibility. All employees are accountable for the use of delegated authority. Each supervisory employee, at all levels of the Agency, is accountable for the activities of employees under his immediate control.

When duties and/or responsibilities are fixed by this section, by job descriptions or by directives and/or orders from superiors, employees shall fulfill those duties and responsibilities to the best of their abilities within the framework of their position and the resources provided.

Reference should be made to the Agency Organizational Chart (see Chapter 2, Section 200.1), and its various sub-charts (see Chapter 2, Sections 200.2 - 200.13), displayed on the following pages. These charts, in conjunction with the narrative descriptions of Agency components and their duties and responsibilities, provide an explanation of the Agency's organizational functions.

All of the Agency's organizational charts are maintained within the Administrative and Operational Manual which is available at all times to Agency employees via the Agency intranet and to the general public via the Agency web site.



2-200.1 ORGANIZATIONAL CHART - ENTIRE AGENCY

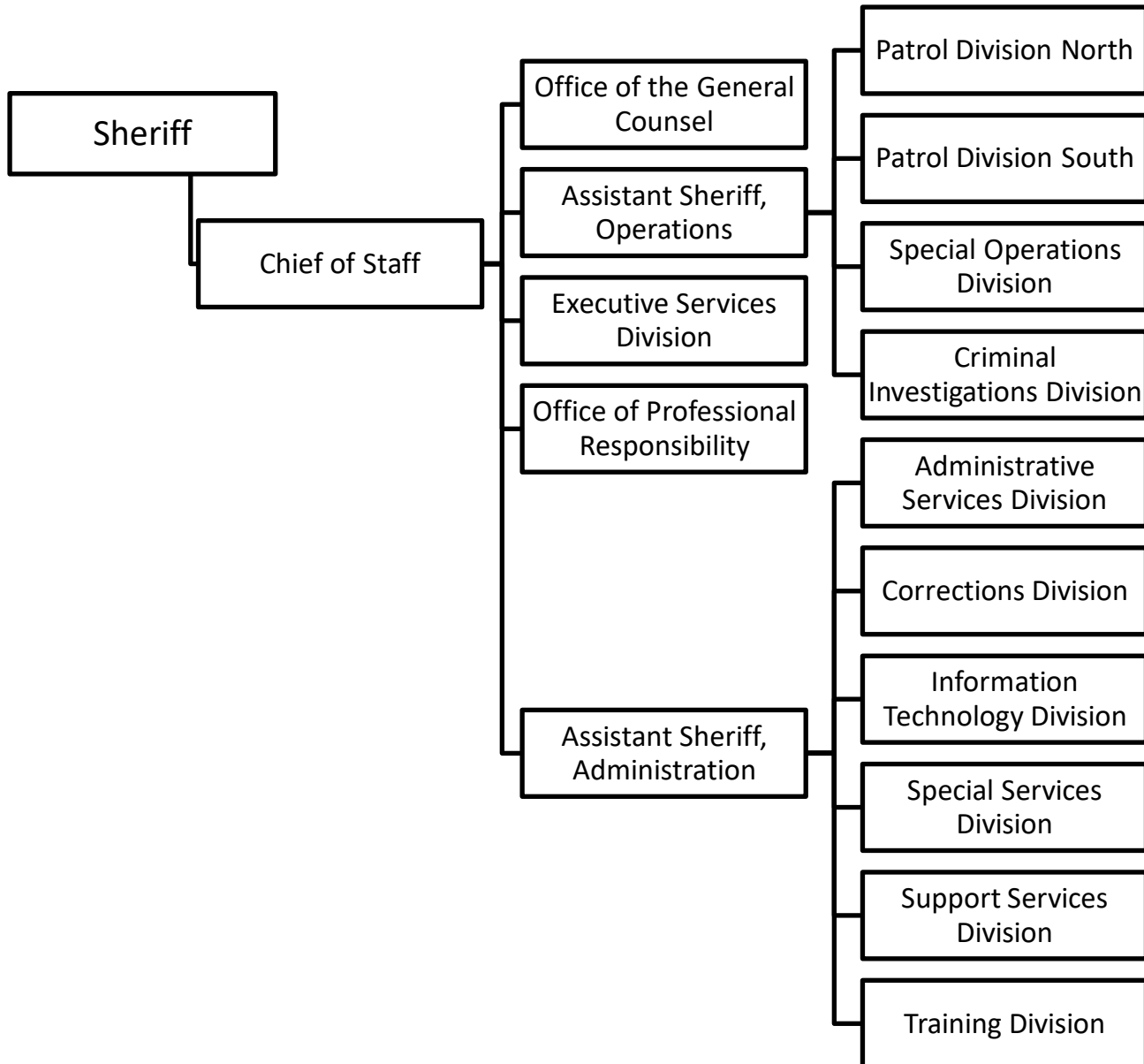





2-200.2 ORGANIZATIONAL CHART - OFFICE OF THE SHERIFF

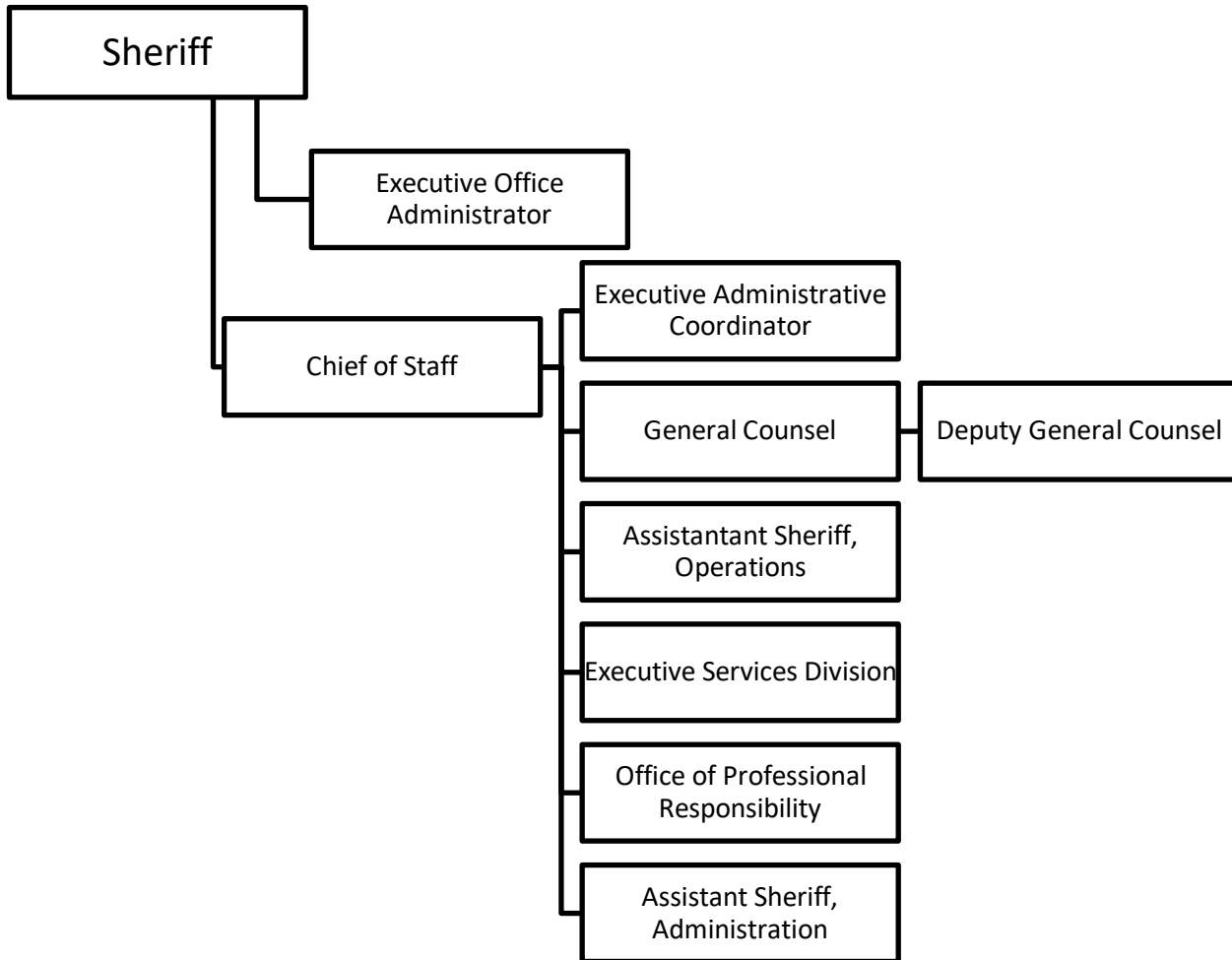



Administrative and Operational Manual

September 12, 2022

2-200.3 ORGANIZATIONAL CHART - PATROL OPERATIONS

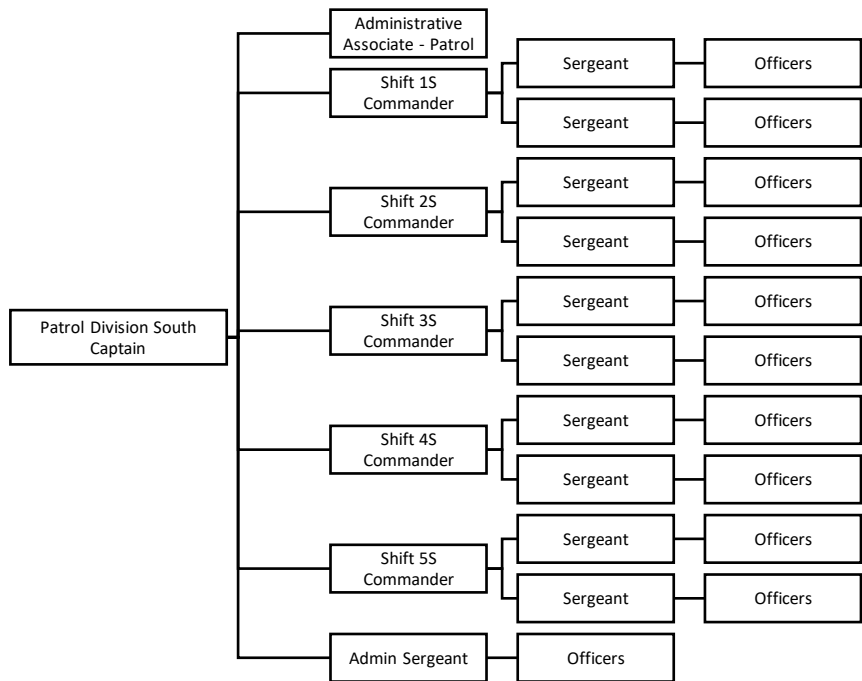
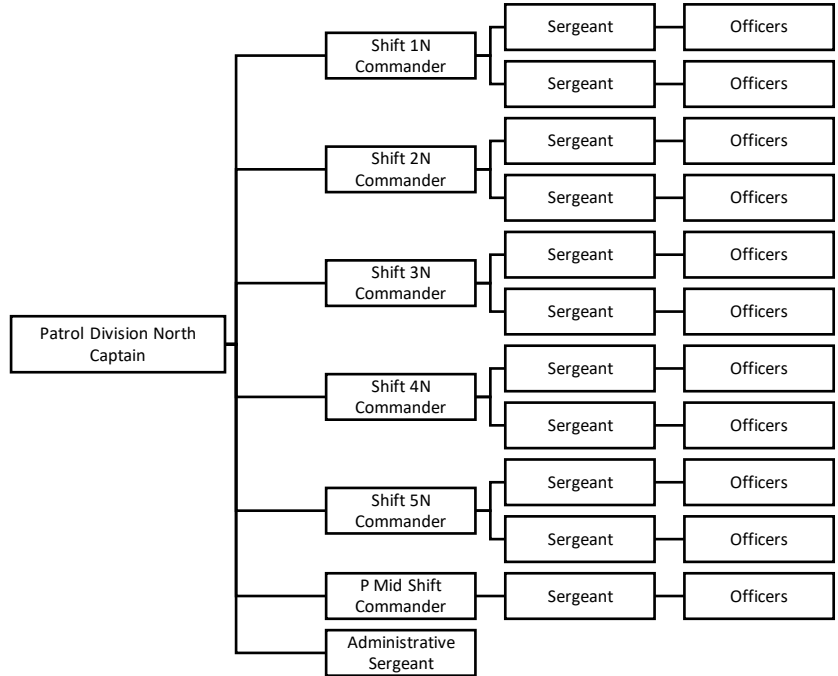



Administrative and Operational Manual

September 12, 2022

2-200.4 ORGANIZATIONAL CHART - SPECIAL OPERATIONS DIVISION

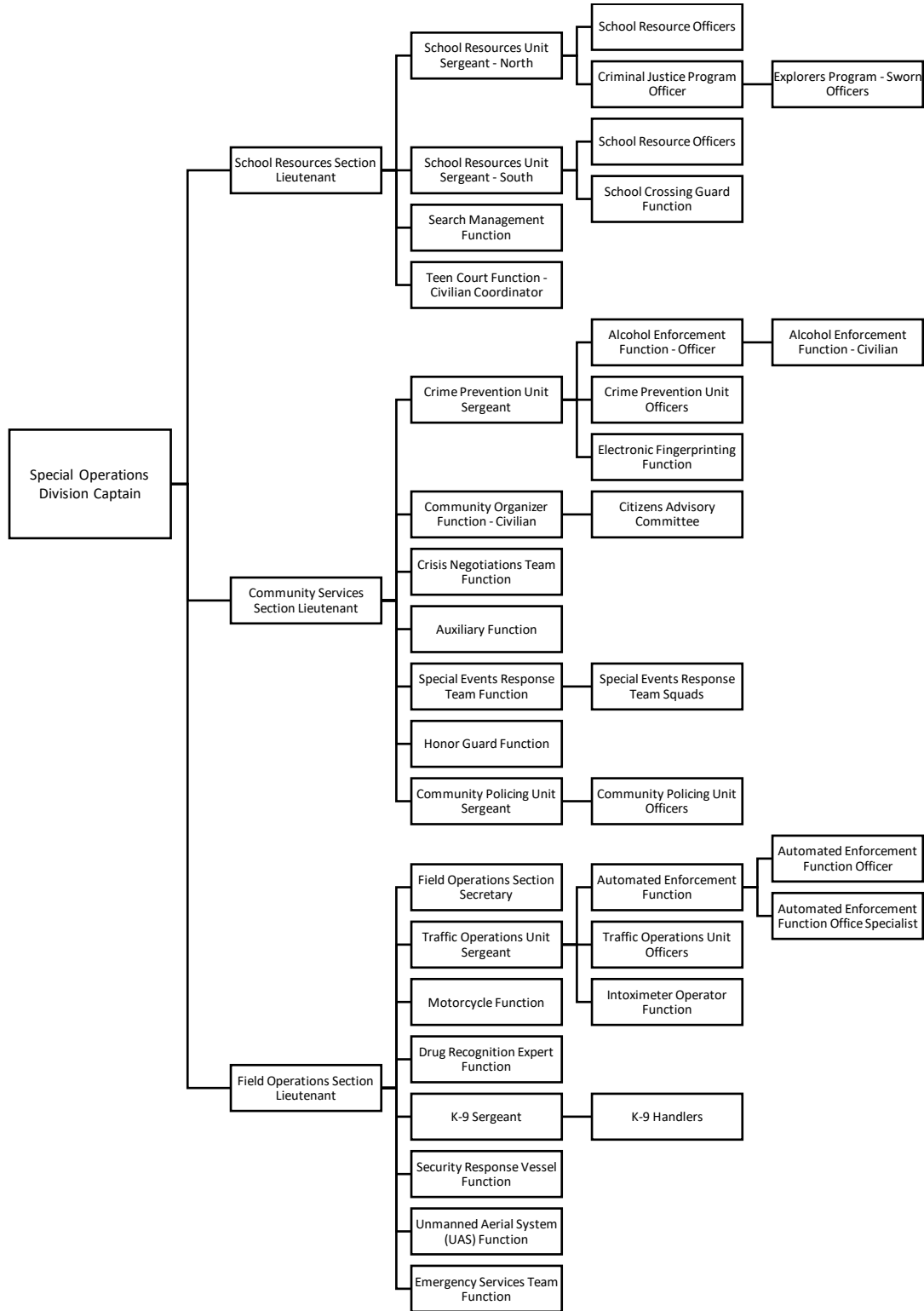



Administrative and Operational Manual

September 12, 2022

2-200.5 ORGANIZATIONAL CHART - CRIMINAL INVESTIGATIONS DIVISION

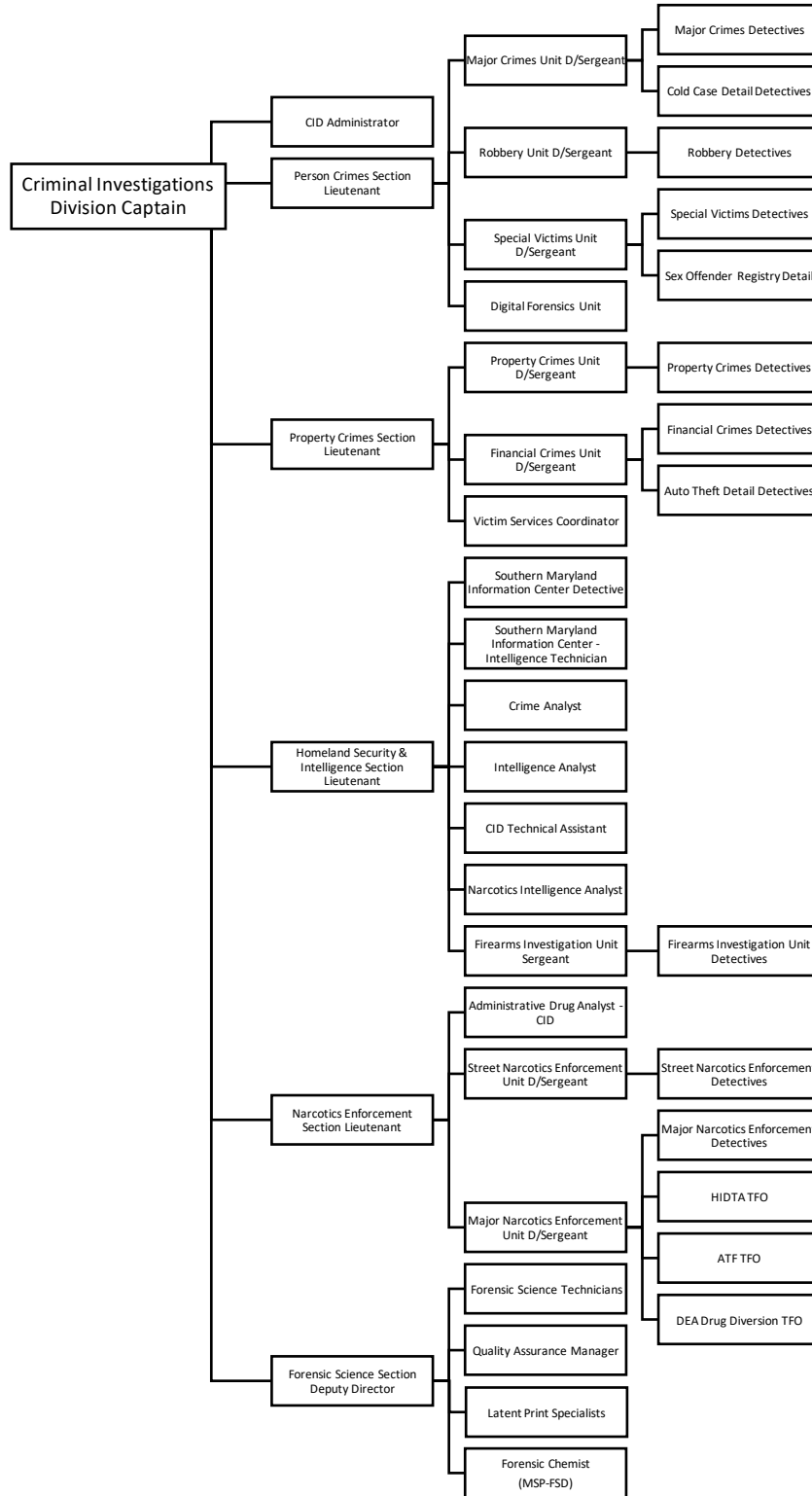



Administrative and Operational Manual

September 12, 2022

2-200.6 ORGANIZATIONAL CHART - CORRECTIONS DIVISION

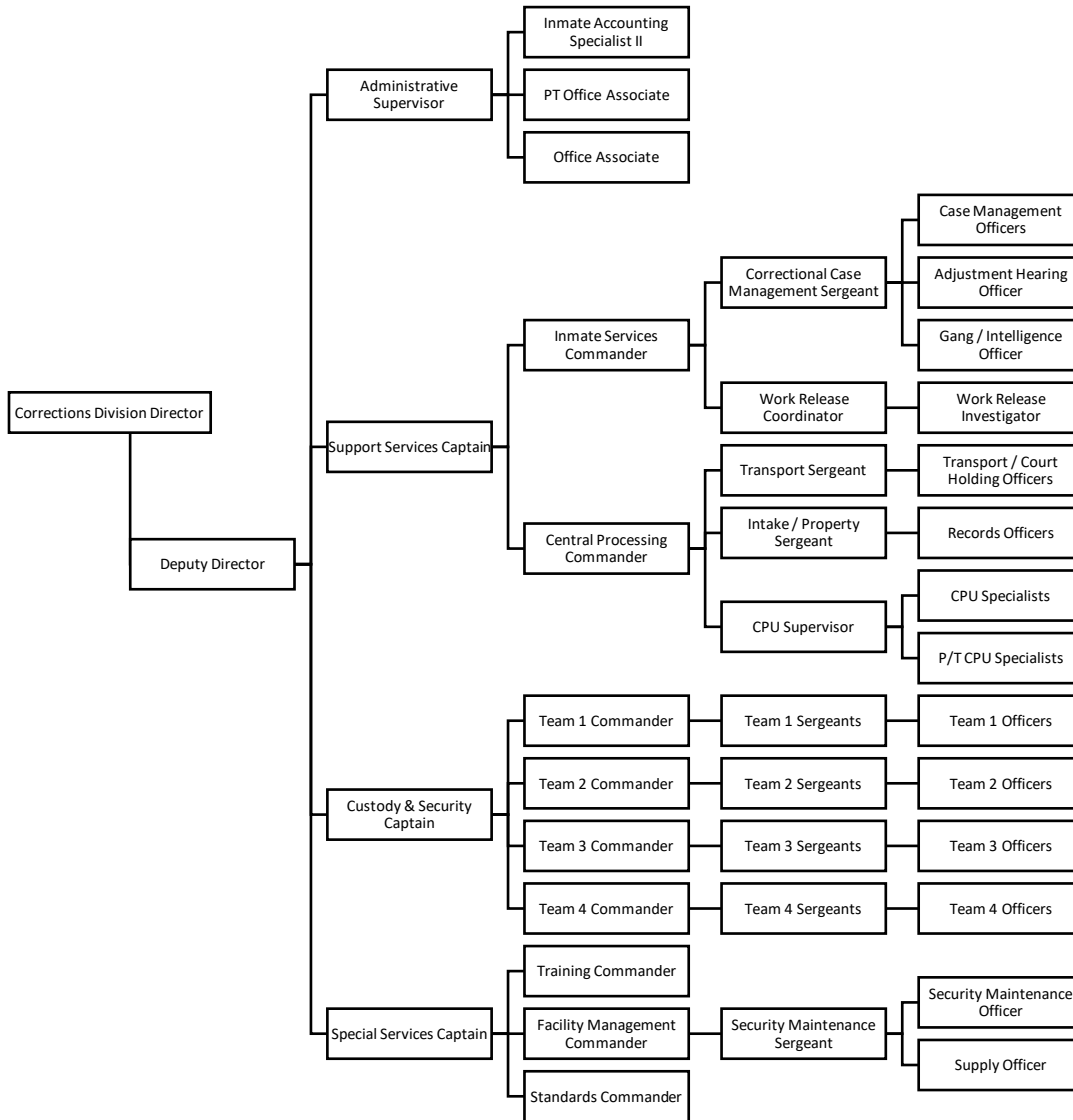



Administrative and Operational Manual

September 12, 2022

2-200.7 ORGANIZATIONAL CHART - SPECIAL SERVICES DIVISION

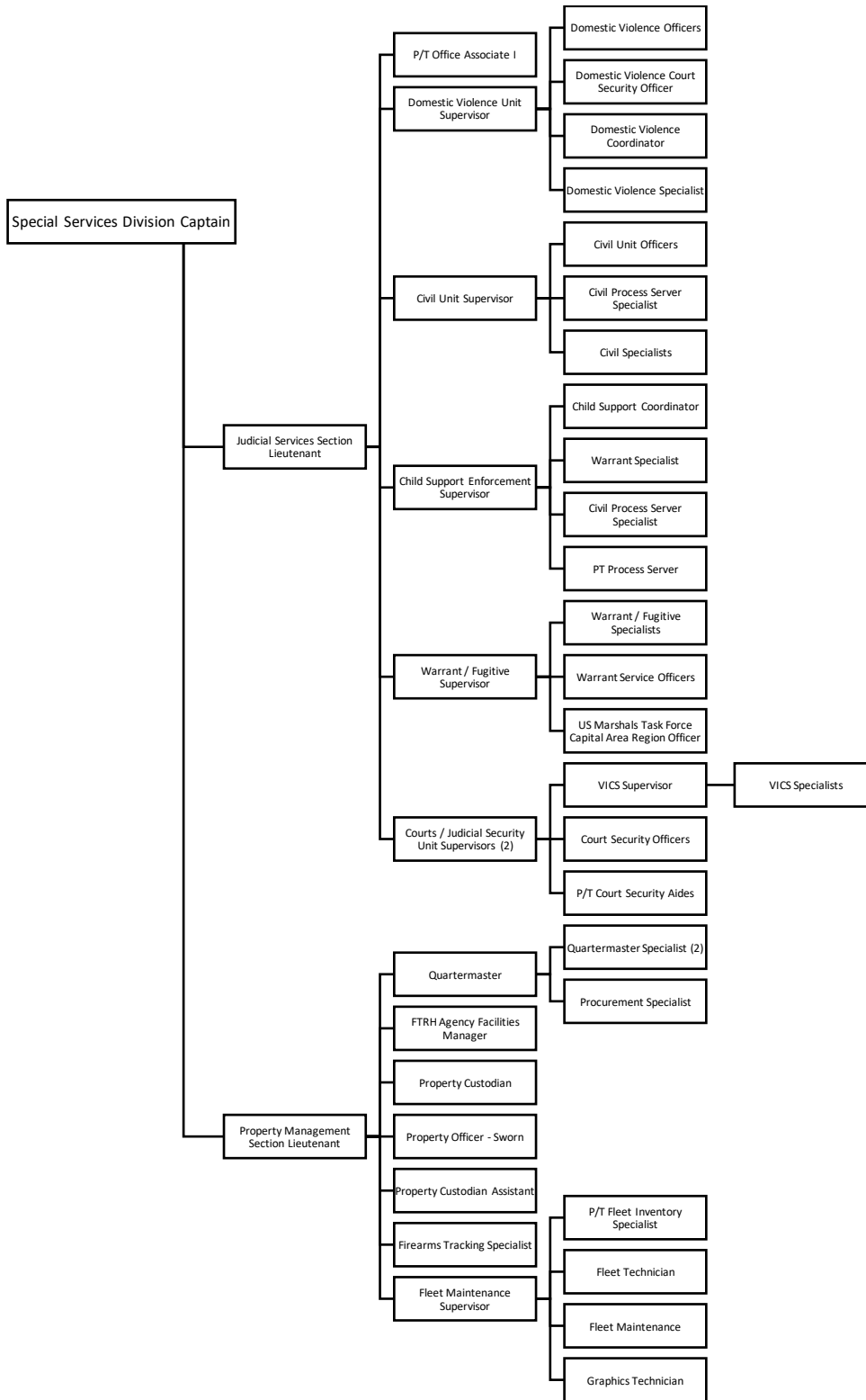



2-200.8 ORGANIZATIONAL CHART – SUPPORT SERVICES DIVISION

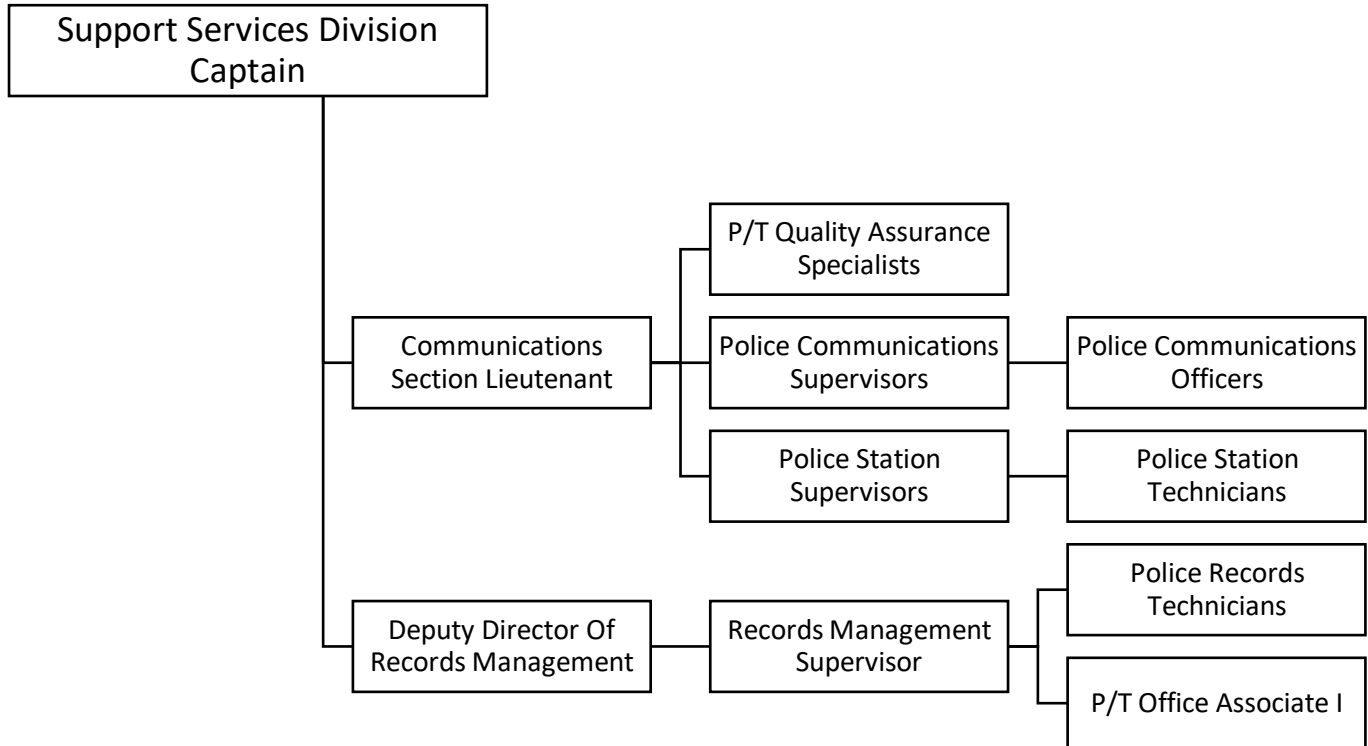



2-200.9 ORGANIZATIONAL CHART - EXECUTIVE SERVICES DIVISION

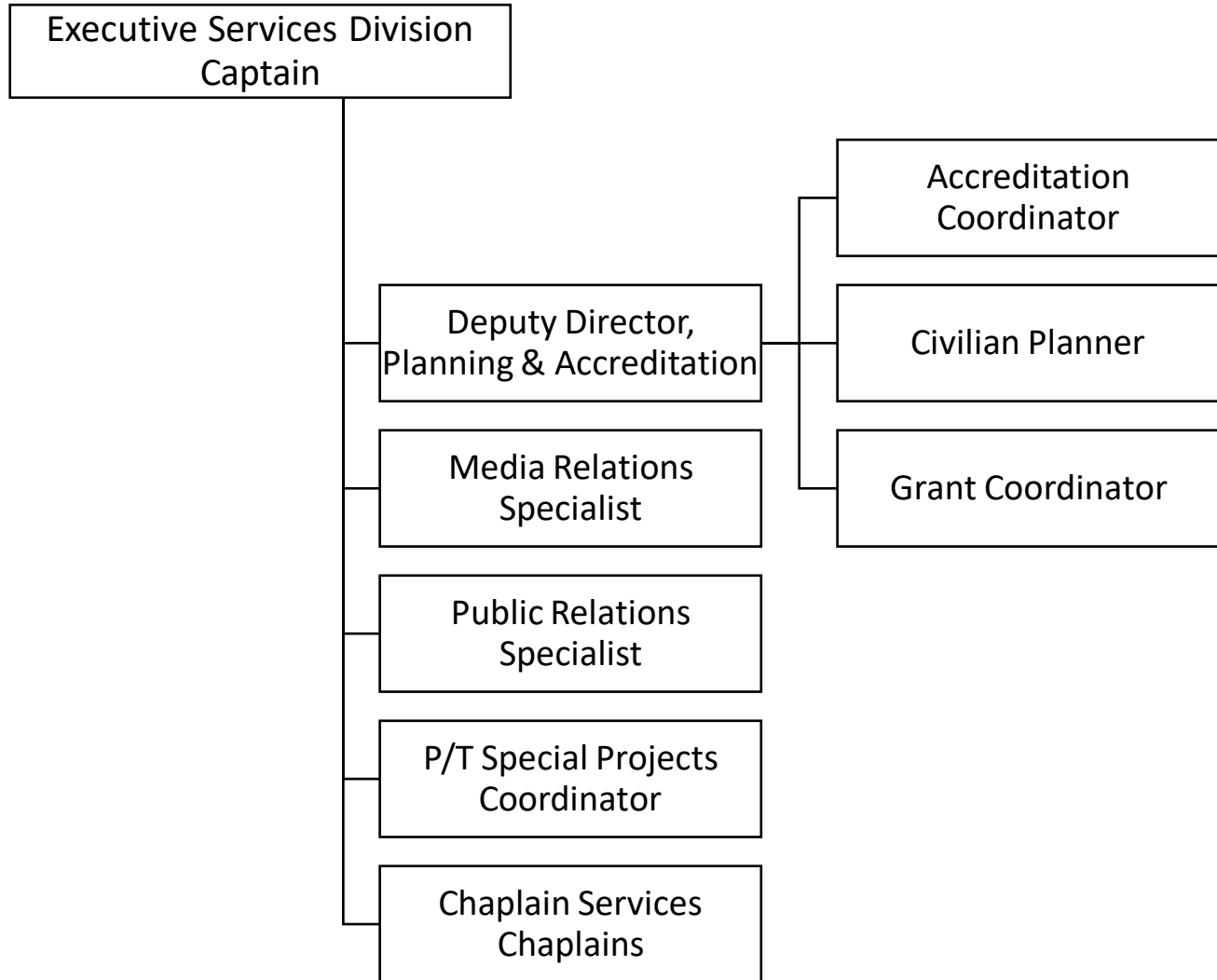





2-200.10 ORGANIZATIONAL CHART - TRAINING DIVISION

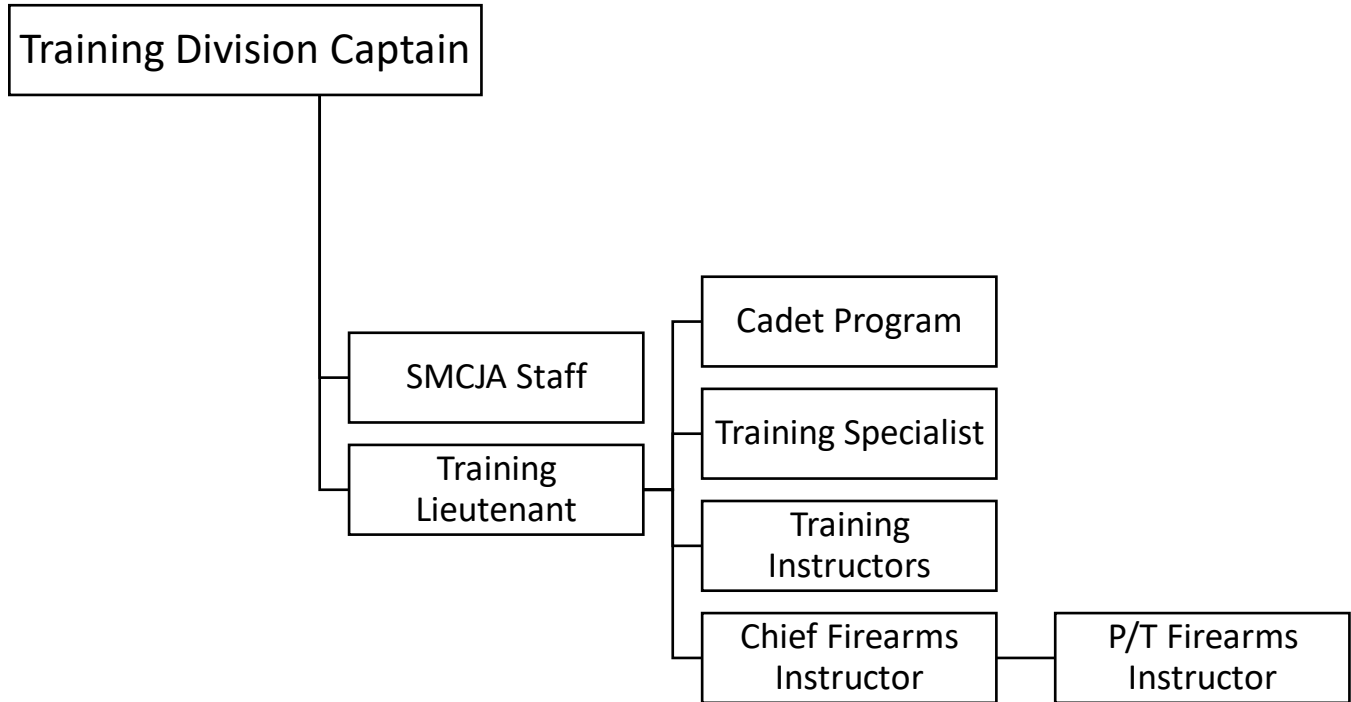



Administrative and Operational Manual

September 12, 2022

2-200.11 ORGANIZATIONAL CHART - ADMINISTRATIVE SERVICES DIVISION

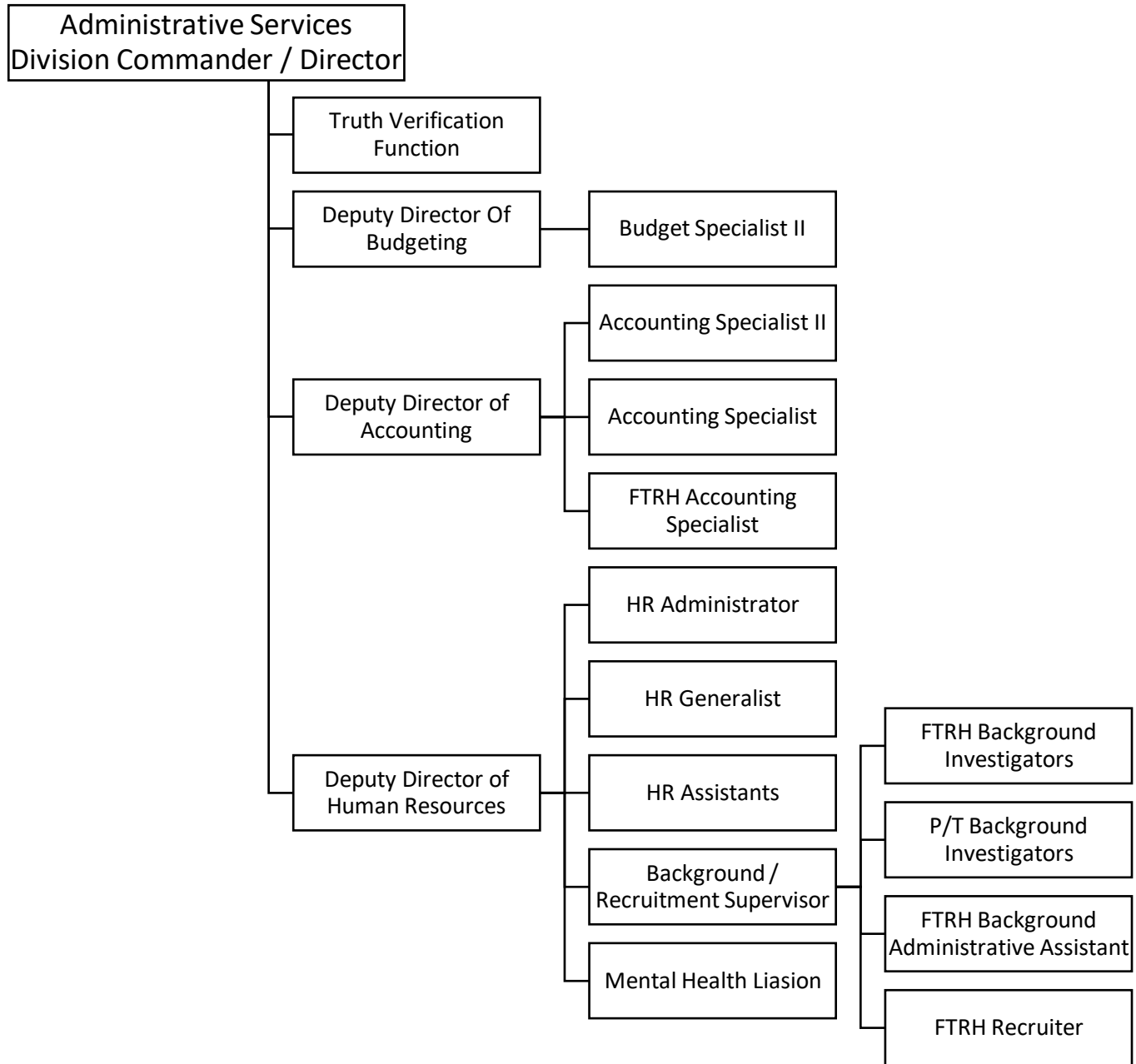



2-200.12 ORGANIZATIONAL CHART - INFORMATION TECHNOLOGY DIVISION

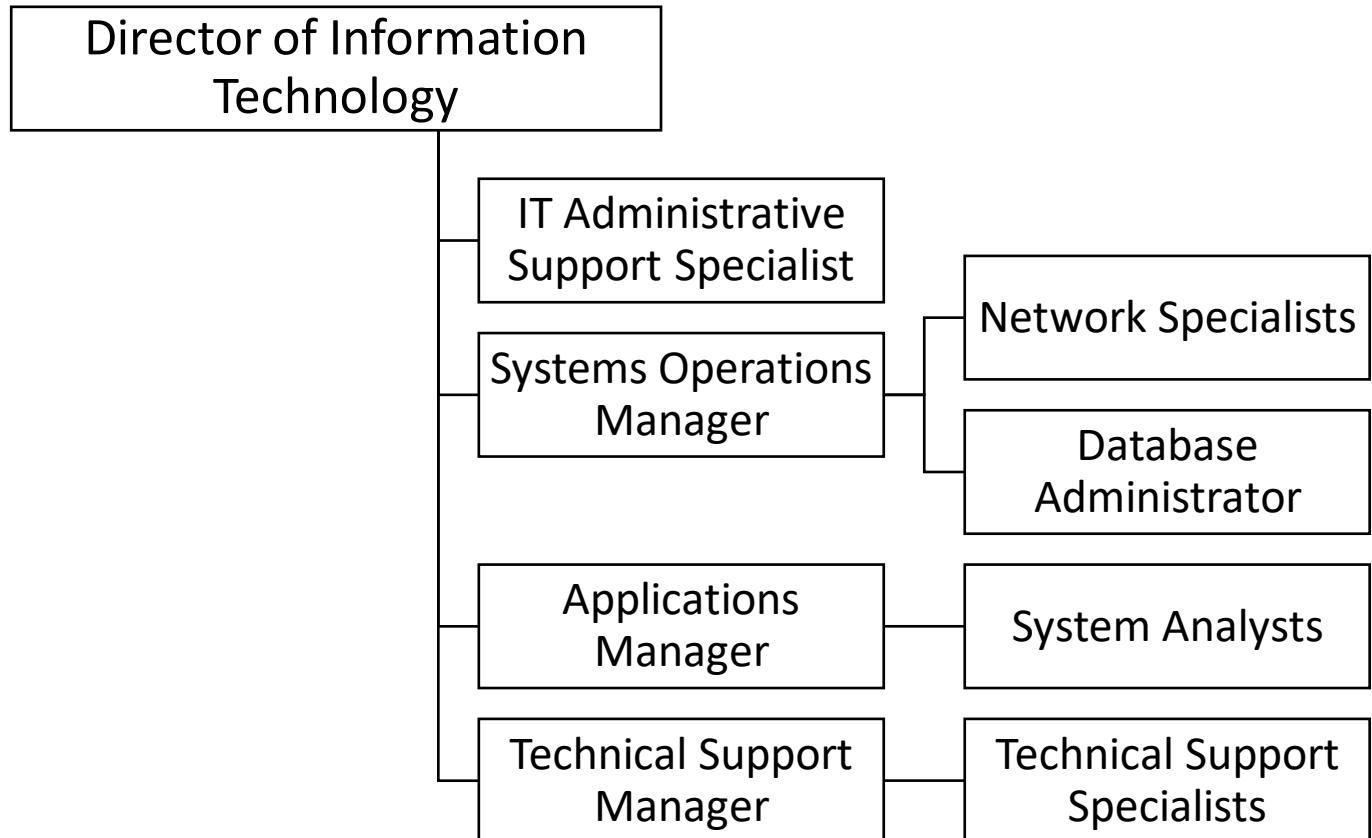



2-200.13 ORGANIZATIONAL CHART – OFFICE OF PROFESSIONAL RESPONSIBILITY

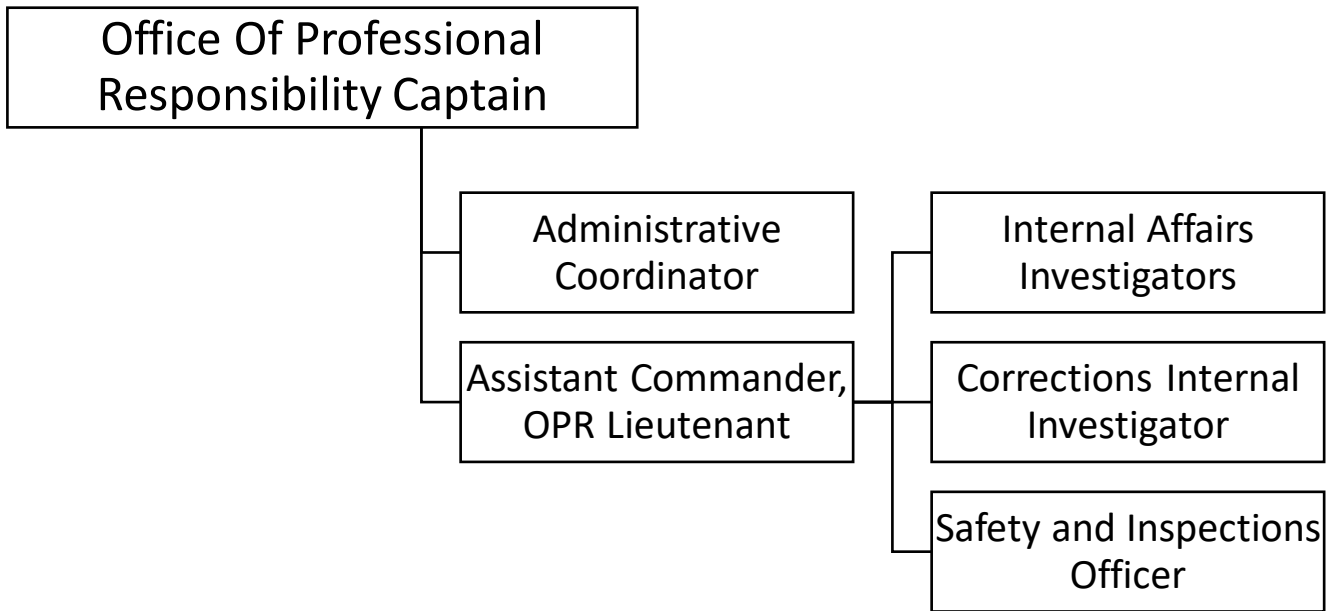



Administrative and Operational Manual

September 12, 2022

## 2-250 OFFICE OF THE SHERIFF

The Office of the Sheriff is comprised of the Sheriff, the Chief of Staff, Assistant Sheriffs, the Office of Professional Responsibility, the Office of the General Counsel, and the Executive Office Administrator. The functions and duties of these components are outlined and explained in the following sections. The organizational chart for the Office of the Sheriff is found at Chapter 2, Section 200.2.

### 2-250.1 DUTIES AND RESPONSIBILITIES OF THE SHERIFF

The Sheriff is an elected State Official who has duties and responsibilities assigned by the Maryland State Constitution, the Common Law and Statutory Law of the State of Maryland. Some of the duties and responsibilities of the Sheriff are found in the following list. This list is for informational purposes and places no additional duty or responsibility upon the Sheriff, not already found in law.

The Sheriff:

- is the final authority for all matters of policy, operations, and discipline;
- establishes orders, rules, and regulations for the administration of the Agency;
- is the final approval authority for all additions, deletions, or changes to the AOM;
- is the authority for all planning, direction, coordinating, controlling, and staffing activities of the Agency;
- is architect and approval authority for the Agency's organizational structure;
- provides for the oversight of the efficiency and effectiveness of all Agency operations and functions;
- provides direction to maintain all Agency functions and operations within the framework provided by law;
- provides for the maintenance of cordial and effective relationships between the Agency, other government agencies, political entities, the business community, civic organizations, and the citizens;
- provides for Agency staffing by presenting requests for funding to the Charles County Commissioners and through such other avenues of revenues as may be appropriately available for this purpose;
- administers funds to accomplish the Agency's goals and objectives;
- provides for the establishment and maintenance of goals and objectives for the Agency;
- establishes standards of performance and moral character for the Agency's employees;
- establishes the various duties and responsibilities for components of the Agency and its employees;
- provides training and leadership to employees in order to accomplish the goals and objectives of the Agency.

Per the Courts and Judicial Proceedings Article (CJ §2-309) of the Annotated Code of Maryland, the Sheriff will designate in writing his Second in Command, who will, on the death, disqualification, or resignation of the Sheriff or in the event the Sheriff is convicted of a felony, shall succeed to the powers, duties, responsibilities, and obligations of the Sheriff until a successor is appointed by the Governor.



**Administrative and Operational Manual**

**September 12, 2022**

**2-251 CHIEF OF STAFF**

The Chief of Staff position within Charles County Sheriff's Office can be filled by a sworn officer the rank of Lieutenant Colonel or a civilian. It is the highest responsible senior administrative and supervisory authority of all employees of the Agency. The Chief of Staff will have duties, assignments, and authority as prescribed by the Sheriff. Each division of the Agency shall report to their assigned Assistant Sheriff, who in turn will report directly to the Chief of Staff, who reports directly to the Sheriff. The Commander, Office of Professional Responsibility, the Commander, Executive Services Division and General Counsel report directly to the Chief of Staff.

**2-252 ASSISTANT SHERIFFS**

Two Assistant Sheriffs are responsible for the day-to-day operations of the Agency. The Assistant Sheriff of Operations is a sworn officer, appointed to the rank of Major, and is responsible for Patrol Operations, the Special Operations Division, and the Criminal Investigations Division. The Assistant Sheriff of Administration is a sworn officer appointed to the rank of Major or a civilian employee appointed to the Assistant Sheriff position. He is responsible for the Corrections Division, Special Services Division, Support Services Division, Information Technology Division, Training Division, and Administrative Services Division.

In addition to, and/or as enumerated by, the position description for his position, each Assistant Sheriff will have the following duties and responsibilities:

- provide direct supervision of the division commanders / directors and other personnel who report immediately to them;
- provide the Sheriff with timely and complete information concerning all the activities under their direct control and any information received having a significant impact upon the Agency, its areas of responsibility, or its operations;
- continually monitor the functions and personnel under the command and control of their positions in order to determine proper functioning;
- make recommendations to the Sheriff for improvements in policies and procedures in order to enhance the effectiveness and efficiency of the Agency;
- coordinate efforts in response to unusual occurrences, marshaling the resources of the Agency and acting as advisor to the Sheriff (specifically the Assistant Sheriff of Operations will be responsible for the All Hazards Plan and planning for unusual occurrences);
- authorize policy documents for inclusion in the Agency Manual on behalf of the Sheriff;
- assure the Agency's compliance with CALEA Standards by working with the Deputy Director, Planning & Accreditation in order to integrate these Standards into the Agency culture; and
- make recommendations to the Sheriff for development of both long- and short-term goals establishment.

In addition to the duties and responsibilities outlined in this section of policy, during the day-to-day operation of the Agency, the order of rank precedence of sworn personnel as defined in Chapter Two of the AOM shall be followed.

**2-252.1 EXECUTIVE ADMINISTRATIVE COORDINATOR**

The Executive Administrative Coordinator reports directly to the Lieutenant Colonel/Chief of Staff. This position provides administrative clerical support to the Assistant Sheriffs, the Captains, and such other duties as may be



Administrative and Operational Manual

September 12, 2022

assigned by the Lieutenant Colonel/Chief of Staff.

## 2-260 OFFICE OF PROFESSIONAL RESPONSIBILITY

The Commander, Office of Professional Responsibility (OPR) is a sworn officer the rank of Captain. The Commander reports directly to the Chief of Staff. In addition to, and/or as enumerated by, the position description for this position, the Commander will assume all responsibilities for tasks assigned to the Office of Professional Responsibility and its various components. Many of those tasks are outlined in this Manual; however, others may be assigned by the Chief of Staff.

The Assistant Commander, Office of Professional Responsibility, is a sworn officer the rank of Lieutenant. The Assistant Commander reports directly to the Commander, OPR. In addition to, and/or as enumerated by, the position description for this position, the Assistant Commander provides direct supervision to the Internal Affairs and Standards and Inspections sections of the OPR.

In addition to responsibilities outlined elsewhere in the Manual, the Office of Professional Responsibility will:

- Inspect and ensure adequate control of the storage and destruction of seized drugs, weapons, and contraband;
- Inspect and ensure adequate control of Agency cash funds;
- Establish procedures for, and when necessary, conduct, integrity checks;
- Maintain all Agency records of complaints against the Agency or its employees, internal investigations, and Use of Force reports, keeping these records in secure and confidential files;
- Maintain statistical data regarding disciplinary actions and assist division commanders and the Assistant Sheriffs to ensure the even and fair administration of the disciplinary process;
- Coordinate and provide support for all administrative hearing boards; and
- Complete and submit the Officer Discipline and Serious Officer Incident reports (ODSOI) to the Maryland Police Training and Standards Commission by January 31 each year, in accordance with Maryland Public Safety Article §3-207(b)(1).

## 2-261 INTERNAL AFFAIRS SECTION

The Internal Affairs Section is staffed by one sworn and one correctional officer who report directly to the Assistant Commander, Office of Professional Responsibility. The Section shall be responsible for the following:

- Administer the investigation and resolution of all complaints of alleged misconduct by the Agency or Agency personnel;
- Coordinate and provide support for all emergency suspension hearings; and
- Conduct or review an investigation into each use of force incident where a person is seriously injured or death occurs.

## 2-262 RECEIVING COMPLAINTS

A **complaint** is defined as any allegation of misconduct. Allegations against the Agency or its employees which, if



Administrative and Operational Manual

September 12, 2022

true, do not rise to the level of misconduct, are not considered complaints. Additionally, lawsuits against the Agency or its employees, in and of themselves, are not considered complaints, but may be investigated by the OPR if deemed necessary.

Anyone receiving a complaint either internally or externally that cannot be resolved during the initial contact with the complainant, shall document the complaint on a Complaint Form #145. If preferred or requested by the complainant, they may be referred to the location of the Complaint Form #145 on the Charles County Sheriff's Office internet site at [www.ccsso.us](http://www.ccsso.us) – “Contact Us” – “Complaints and Commendations” or a copy may be printed and provided to them. The Commander, OPR, will be responsible for the design and availability of complaint forms.

If submitted by an Agency employee, the completed form shall be sent to the OPR through the employee's chain of command. In cases where immediate attention is required, the Commander, OPR, or his designee may be contacted directly.

If submitted by a civilian complainant, the completed form may be delivered to the OPR in person, sent to the OPR via U.S. Postal Service, or emailed directly to [OPR@ccso.us](mailto:OPR@ccso.us).

Based on the allegations, the desire of the complainant, or the need for further investigation, complaints may be handled in a formal or informal manner. The Commander/Assistant Commander, OPR, and/or the employee's Division Commander shall make that determination.

The OPR maintains a flow chart to aid each Division Commander with the complaint handling process, including receiving complaints, the investigative process and the final discipline involving allegations of employee misconduct. A copy of the flow chart is also located on the Agency intranet site under the “Resources” drop down menu titled “Initial Complaint Handling Process.”

The Internal Affairs Section shall make available to the public, through the media or the Agency's community relations programs, information regarding the method for making a complaint and ensure forms are available for this purpose. This information will also be disseminated to all Agency personnel.

All complaints will be reviewed by a Division Commander and/or OPR. All complaints requiring investigation will be screened by the Commander, OPR, or designee, and assigned for investigation by an Internal Affairs investigator, or directed to a Division Commander for assignment to a division investigator. The Internal Affairs Section will retain staff supervision of all investigations and will monitor their progress.

The Commander, OPR will report the receipt of all complaints to the Chief of Staff and Assistant Sheriffs who will make appropriate notifications to the Sheriff. If necessary, due to the sensitivity of the complaint, notifications of the receipt of the complaint may be limited.

The Commander, OPR will ensure each person submitting a complaint against the Agency or Agency personnel is contacted acknowledging receipt of the complaint. The Commander will also ensure the complainant is provided periodic progress reports of the investigation status and a notification of the results of the investigation upon its conclusion.

## 2-262.1 DOCUMENTATION OF COMPLAINTS

The Commander, OPR or a designee will ensure that all complaints concerning this Agency or members of this Agency are documented, regardless of origin. Documentation will consist of maintaining an active investigative file, and master file. The master file is kept electronically in the IA Pro Internal Affairs tracking software program. The active investigative file will be maintained by the investigating detective, and filed in the secure file room located in the OPR once the investigation is finished and the administrative process is complete.

In addition to other statistical information entered and tracked in the IA Pro program, the OPR documents and maintains files on two types of complaints. They are as follows:





**Administrative and Operational Manual**

**September 12, 2022**

- IA – cases assigned for investigation to an OPR investigator or to an investigator in the field; and
- M – miscellaneous complaints received and reviewed by the OPR and determined to contain no policy violation. In miscellaneous cases, a representative of the OPR will contact the complainant, explain the disposition, and answer any questions they may have.

**2-262.2 AVAILABILITY OF OPR PERSONNEL**

Internal Affairs Section personnel will be available 24 hours per day, 7 days per week. The Commander, OPR or his designee shall be contacted when OPR assistance is required.

**2-265 STANDARDS, INSPECTIONS, AND SAFETY OFFICER**

The Standards and Inspections / Safety Officer reports to the Assistant Commander, OPR. This position manages special projects of the Agency as provided in the position description or assigned by the Assistant Commander, OPR. The position assumes all the duties and responsibilities outlined in Chapter 6 of this Manual and those rules and regulations of the Maryland Occupational Safety and Health Administration (MOSHA) and the Occupational Safety and Health Act (OSHA). In the AOM, this position may alternately be referred to as the Safety Officer.

Safety audits will be conducted in accordance with MOSHA / OSHA specifications and notifications made to Division Commanders, documenting findings. All required reports are generated under the supervision of the Assistant Commander, OPR. The Commander, OPR will report any significant issues to the Assistant Sheriff of Administration.

In addition to the previously described duties and responsibilities, the Standards and Inspections / Safety Officer will conduct comprehensive reviews of the following:

- Reportable Use of Force Incidents
- High Speed Pursuits

Upon completion of the review, a detailed memorandum will be written and forwarded to the Assistant Commander, OPR for final review. If Agency policy violations are discovered during the review, the Division Commander of the involved employee will be notified to handle appropriately within their division. On occasion, the Commander, OPR or his designee may assign the violation an Internal Affairs tracking number to be investigated by the Internal Affairs Section or assigned as a Field Investigation.

**2-270 OFFICE OF THE GENERAL COUNSEL**

The Office of the General Counsel is assigned to represent the Office of the Sheriff. In accordance with Maryland law, the Attorney General's Office is primarily responsible for representing and advising the Sheriff for Charles County, Maryland, in matters of traditional constitutional duties of the office of the Sheriff. However, to ensure prompt, thorough, and consistent legal advice, the Sheriff, the County, and the Attorney General have mutually agreed that an Attorney shall act as a General Counsel to the Sheriff's Office and is responsible for:

- providing legal advice regarding the daily operations of the Agency; and
- serving as a liaison between the County Attorney's Office and the Agency; and
- serving as a liaison between the Attorney General's Office and the Agency; and
- coordinating responses in civil suits against the Sheriff, the Agency, and its personnel with the County Attorney and the Attorney General; and



**Administrative and Operational Manual**

**September 12, 2022**

- 
- providing legal representation in various courts for the Sheriff, the Agency, and its personnel either at the direction of the Sheriff or at the request of the County Attorney; and
  - examining rules, policies, and procedures of the Agency for legal sufficiency and form; and
  - representing the Agency, when requested, during Administrative Hearing Boards, both internally and externally; and
  - providing on-going information and training regarding current legal issues which may impact the Agency; and
  - serving as the Agency's legislative liaison with the various legislative bodies at the local, state, and national level.

The legal staff assigned to the Office of General Counsel is responsible for providing administrative and clerical support to the General Counsel to the Sheriff.

**2-280 EXECUTIVE SERVICES DIVISION**

The Executive Services Division is responsible for and supports functions in the Agency relating to policy in the Administrative and Operational Manual, division and section SOPs, Agency forms, the Grants Function, and the Accreditation process. The division is also responsible for the activities which are related to the Media Relations Office and Chaplain Services.

**2-281 EXECUTIVE SERVICES COMMANDER**

The Executive Services Division Commander, a sworn position, is directly responsible to the Chief of Staff. The Commander is responsible for the direct supervision of subordinate personnel and the performance of administrative duties pertaining to the daily operation of the division. He is responsible for the performance of all personnel assigned to his command.

The Commander is responsible for ensuring employee(s) assigned to the function of Accreditation Manager shall receive specialized Accreditation Manager training within one year of being appointed to this function. At a minimum, the training should include information on the essential components of the process, the standards manual, file maintenance, and on-site assessment procedures.

The Executive Services Division Commander shall inspect the personnel, equipment, facilities, and other resources assigned to his command on a regular basis. He shall be responsible for maintaining these elements of his command in compliance with the policies set forth in this Manual and in other official directives of the Agency.

**2-282 PLANNING & ACCREDITATION**

Planning & Accreditation is administered by a civilian Deputy Director. The Deputy Director shall have access to all components and resources of the Agency in order to fulfill the responsibilities of the dual role of Planning & Accreditation. The Deputy Director reports to the Executive Services Commander.

Planning & Accreditation has a policy development function responsible for (at the direction of, and with the approval of, the Sheriff or Assistant Sheriffs) the creation, revision, and deletion of Agency policy contained in the Agency Manual. This function also creates, edits, revises, and publishes SOP Manuals, with the approval of, and for, the various component commanders. Planning & Accreditation is responsible for the maintenance of the accreditation files and the oversight of the process of accreditation, as well as the securing and management of grants through the Grant Coordinator.



**Administrative and Operational Manual**

**September 12, 2022**

This section may be comprised of sworn and/or civilian planners and civilian support staff. The Deputy Director oversees all the planning and accreditation activities of the Agency. These include, but are not limited to:

- management of the Agency AOM;
- assistance to various Agency Commanders in the development of section and unit SOPs;
- evaluation of new technologies and products applicable to the Agency's activities;
- development of Agency mission statements, goals and objectives, to include an Agency Strategic Management Plan;
- refinement of the Agency organizational structure;
- development of plans for improvement of operations and processes;
- evaluation of training technologies and recommendations for improvement;
- assistance to Agency personnel in developing presentation and publishing techniques;
- creation and maintenance of all Agency forms for general and component use;
- coordination of the Agency SMP as outlined in Chapter 1, Section 001.3;
- implementation and completion of the Agency's formal accreditation, and, after acquisition, maintenance of accreditation with CALEA;
- application for and securing of grants for Agency programs and capital improvements.

**2-283      MANUAL MAINTENANCE / POLICY DEVELOPMENT FUNCTION**

The policy development Planner receives general supervision from and reports to the Deputy Director, Planning & Accreditation. He is responsible for analyzing information from many sources and determining from that information the need for changes in Agency policy and procedures. This employee will complete tasks associated with the creation and publication of documents, including the Agency AOM and SOPs, creation and maintenance of files and file systems, and be responsible for other duties as assigned. He shall maintain an awareness of technological advancements in the field of law enforcement and evaluate their applicability to the Agency.

**2-284      ACCREDITATION COORDINATOR**

The Accreditation Coordinator receives general supervision from and reports to the Deputy Director, Planning & Accreditation. The Coordinator is responsible for acquiring materials from each division pertaining to the accreditation process and entering them into the accreditation files, as well as maintaining and updating them as necessary. He is responsible for ensuring that written policy conforms to the CALEA standards.

In addition, the Accreditation Coordinator will create, revise, and maintain all Agency forms for general and component use. He will be responsible for maintaining and updating the Agency Forms section on the Agency's Intranet. He will be responsible for all other duties as assigned. Final authority of all forms maintenance will be the responsibility of the Deputy Director, Planning & Accreditation.

**2-286      GRANT COORDINATOR**

The Grant Coordinator is responsible for seeking sources of funding for Agency programs and capital items which are not funded, or are inadequately funded, by the Agency budget process. In this regard, the Grant Coordinator will maintain liaison with state and federal offices and personnel who are responsible for administering grant funding for law enforcement and correctional programs. Additionally, the Grant Coordinator will continually search to find private sources of funding, so long as such funding will not create a conflict of interest with the Agency's mission and goals.

**2-287      CHAPLAIN SERVICES**



**Administrative and Operational Manual**

**September 12, 2022**

Chaplain Services is composed of various members of the community who are experienced representatives of their particular denominational group. Chaplain Services reports to the Executive Services Commander. Their purpose is to minister to the members of this Agency in times of personal need and strife. They will be responsible to conform to the policies defined in the Chaplain Services SOP Manual and to fulfill the duties defined therein; and they will minister to employees, their families, and the Agency as follows:

- assist in the notification of families of employees who have been seriously injured or who have died; and
- comfort and aid injured and sick employees or other members of the police family who may be in our community; and
- provide comfort and aid to employees who have suffered a loss of a family member or who are caring for a seriously ill or injured family member; and
- aid employees who must make death notifications within the community as a result of the performance of their duties; and
- provide moral and spiritual guidance to employees and their families; and
- act as a liaison for the Sheriff and the Agency between the various religious leaders and their congregations, and the Agency in matters of mutual concern.

**2-288 MEDIA RELATIONS OFFICE**

The Media Relations Office is responsible for developing, coordinating, directing, and administering policies relating to all phases of public relations in accordance with the mission, objectives, directives, and policies of the Sheriff's Office. The Media Relations Office is responsible for establishing and maintaining a close working relationship with employees of the Agency, elected officials, the press, the general public, and peer groups.

The relationships maintained between the Media Relations Office and the news media will be developed and maintained to promote a harmonious symbiotic effort. To this end, whenever there is an apparent need to change or develop new policies regarding the Media Relations Office, the news media will be involved in that process. Their comments and interests will be evaluated in the final decision making.

**2-289 MEDIA RELATIONS SPECIALIST**

The employee in this critical position will be the Media Relations spokesperson for the Sheriff's Office, directing the communications strategy for all matters of public policy and crisis communication. The Media Relations Specialist will make descriptions of crimes and other recent incidents that required a police response available to the media through the completion and distribution of regular incident briefings. Incident briefings must be approved by the Commander, Executive Services, prior to distribution to the media. The employee receives supervision from, and reports directly to, the Commander, Executive Services Division.

**2-290 PUBLIC RELATIONS SPECIALIST**

The employee in this critical position is responsible for participating in the creation, development, coordination, and direction of, as well as the administration of, policies related to all phases of public relations. This position works closely with the Media Relations Specialist in providing internal communication with staff as well as external communication with the public and the media. The employee must establish a working relationship with staff members, elected officials, the press, the general public, and other peer groups. The employee receives supervision from, and reports directly to, the Commander, Executive Services Division.



Administrative and Operational Manual

September 12, 2022

## 2-291 SPECIAL PROJECTS COORDINATOR

The employee in this part-time position performs a variety of technical and administrative duties for the Executive Services Division and the Agency in general. He assists the Media Relations Office with photographing Agency events and creating brochures and flyers. He assists the Planning & Accreditation Section with creating Agency forms. He also plans special events, works on community projects, and coordinates and/or attends meetings as assigned. The employee receives supervision from, and reports directly to, the Commander, Executive Services Division.

## 2-300 PATROL OPERATIONS

Patrol Operations is that component of the Agency which has as its primary responsibility providing the immediate police services required of the CCSO. Patrol Operations must provide preventive patrol in order to deter criminal activity, and discover such activity while it is in progress, if it cannot be prevented. Officers of this component must continually provide for the public safety by regulating the movement of vehicular and pedestrian traffic. They must also find hazardous conditions; i.e., fallen trees, power lines down, hazardous pavement conditions, traffic signals out, high water, unsafe hazardous materials handling, unsecured valuables, health hazards, and any other condition detrimental to the public welfare. Patrol Operations has, as a primary goal, the development and maintenance of a safe and orderly environment for the people who exist within the geographical boundaries of its area of responsibility.

### 2-300.1 ORGANIZATION OF PATROL OPERATIONS

Patrol Operations is comprised of two divisions. The Northern Patrol Division is made up of Districts 3 and 4 in Waldorf. The Southern Patrol Division encompasses District 1 (La Plata) and District 2 (Bryans Road). Each division is under the command of a Captain; and a Lieutenant is assigned to each patrol shift in each division, managing the work of their assigned patrol squads. Patrol Operations consists of the various shifts of officers and their supervisors, who work rotating shifts in order to provide the immediate, 24-hour-a-day, 7-day-a-week, uniformed response to public calls for service. These officers also provide the patrol deterrent to criminal activity and the routine watch for conditions which pose a public danger.

### 2-301 PATROL DIVISION COMMANDERS

Each Patrol Division Commander is a sworn Captain who shall be responsible directly to the Assistant Sheriff of Operations. He is responsible for the direct supervision of subordinate commanders and the performance of administrative duties pertaining to the daily operation of the Division. He is responsible for the performance of all personnel assigned to his command.

Each Patrol Division Commander shall be responsible for:

- initial response to all calls for service which are directed to the Division;
- patrol of all areas of the County with the purpose of crime prevention and detection;
- detection of conditions which present a hazard to the citizens of the County; and
- removal of hazards and/or warning of citizens of such hazards if it is within his ability to do so using the available resources of the Agency and County.

Each Patrol Division Commander shall ensure the inspection of the personnel, equipment, facilities and other resources assigned to his command on a regular basis. He shall be responsible to maintain these elements of his command in compliance with the policies set forth in this Manual and in other official directives of the Agency.



**Administrative and Operational Manual**

**September 12, 2022**

**2-302.1 ADMINISTRATIVE SERGEANTS**

The Administrative Sergeants shall assist the division commanders in fulfilling the responsibilities associated with the supervision within the Patrol Division. The Administrative Sergeants will fill in for a Patrol Supervisor during a temporary absence. In addition to, or as enumerated by, the position description for his position, the Administrative Sergeants shall have the following specific duties and responsibilities:

- present all requested Patrol Division generated criminal cases to the Grand Jury;
- provide assistance to the Charles County State's Attorney's Office with investigative needs relating to those cases;
- supervise and manage the Field Training Officer Program within the Patrol Divisions;
- fulfill such other administrative duties as may be required to facilitate and assist the division commanders.

**2-302.2 ADMINISTRATIVE ASSOCIATE - PATROL**

This position performs a variety of clerical and administrative duties relative to the operation of the Patrol Divisions and provides direct support to the division commanders and shift commanders of Patrol Operations. Assignments are carried out in accordance with general work instructions and established office practices and procedures. The employee receives supervision from, and reports directly to, the Commander, South Patrol Division.

**2-303 SHIFT COMMANDERS**

Shift commanders are sworn officers of the rank of Lieutenant. Shift commanders manage the affairs of the Agency dealing with Patrol Operations during their designated shift schedule. These commanders are also tasked with duties as assigned by their Division command. They are available to make operational decisions which require an immediate response in order to deal with an ongoing or rapidly developing situation. Shift commanders report directly to their Patrol Division Commander. During their assigned duty hours, including standby hours, shift commanders have the responsibility and authority to act for the division commanders unless relieved by a superior officer.

**2-303.1 HOURS OF WORK**

Division commanders will work such hours as are necessary to fulfill the responsibilities of their position and will ensure Patrol has command coverage on a 24/7 basis. Specifically, division commanders must be available from 0600 to 1600, Monday through Friday, or provide for a qualified employee to act in their behalf during these hours. They will make known which shift commander is on duty at any given time. Shift commanders work 10-hour shifts; permanent midnight commanders have set hours, with a 10-hour work day.

**2-303.2 GENERAL RESPONSIBILITIES**

A primary concern of the division commander shall be the relative level of community satisfaction with services rendered by the personnel assigned to the commander's division. The division commander shall also be concerned with all the services provided by the Agency and should take steps to improve these by sharing information with various other component commanders. Division commanders are required to attend community functions in the evenings or weekends, in order to maintain contacts and relationships with the community and its leaders. They should adjust their schedules in order to attend to these matters. Division commanders will, from time to time, be on patrol within their respective districts at night, in the early hours of the morning and at various times on the weekends. They will personally observe their personnel in the performance of their duties at such intervals as



**Administrative and Operational Manual**

**September 12, 2022**

needed, to determine that these duties are being properly carried out. Division commanders will respond to requests from their subordinate supervisors, regardless of the time of day or day of week, if there is a need for the commander's advice or presence. Shift commanders will be delegated tasks when necessary. Likewise, division commanders will respond to direction from their superiors regarding needs to attend to a particular assignment or function.

**2-303.3 COORDINATION WITH OTHER AGENCY COMPONENTS**

The Patrol Division Commanders, although not directly responsible for Criminal Investigations, DARE, Traffic Operations, Community Oriented Policing, or other components of the Agency, are nonetheless responsible for the coordination of all Agency services provided to the businesses, communities, and citizens within the district under their command. Each division commander will, therefore, maintain a close working relationship with the commanders of these other components of the Agency. The commanders of all components of the Agency are required to keep division commanders informed as to operations of their command which occur, or will occur, within a division commander's district. Any operation which could potentially create a conflict or hazardous condition, should the personnel of a district be unaware of its existence, will be revealed to the division commander, or the senior sworn officer on duty if time is short before the operation is to commence, as far in advance as is practical given the nature or sensitivity of the operation. Shift commanders will be delegated tasks when necessary.

In order to foster close working relationships, the division commander will meet with all component commanders whose personnel operate within the commander's district, as often as is necessary. These meetings will occur at least quarterly and will be documented with meeting notes to be filed in each command's files for a period of at least one year. Meeting notes will be shared within each command to the fullest extent possible, except for information which might jeopardize a sensitive operation.

**2-303.4 BUDGET AND RESOURCE MANAGEMENT**

Division commanders will be responsible for determining the manpower, equipment, capital improvements, facilities, supplies and other budgetary needs of their command. In this regard, they will monitor the changes in their communities and adjust annual requests for funding in accordance with these changes.

**2-304.2 SHIFT COMMANDERS' RESPONSIBILITIES**

Shift commanders should, sometime during each tour of duty each day, personally visit each of their Patrol Division's facilities and inspect for security and proper operations. They will report, in writing, any discrepancies to the commander who is responsible for the facility. In addition, they will notify any on-duty supervisor or other employee of conditions which require attention of that employee. If there are no on-duty employees available and the condition warrants immediate attention, the shift commander will cause notification to be made to the responsible off-duty personnel.

Likewise, shift commanders will meet with shift supervisors as necessary during each tour of duty, each day, in order to maintain a close working relationship and personally communicate such directions as may be appropriate. Shift commanders will, on a rotating basis, attend the roll calls of operational components. Shift commanders will observe the inspection of, or personally inspect the personnel assigned to, these operational units. The shift commander will personally report the results of these inspections or will certify the inspection report of the supervisor conducting the inspection. Any discrepancies will be corrected and made part of the report which is to be forwarded to the respective Patrol Division Commander.

**2-304.3 REPORTING AND NOTIFICATION RESPONSIBILITIES**

Shift commanders will report any unusual condition or event which may be of interest to their respective division commander or other component commander. These events may not be otherwise reportable under the policies of



**Administrative and Operational Manual**

**September 12, 2022**

this Manual, but are in the nature of a courtesy report to the component commander notified. Additionally, operational notifications and reports required by this Manual will be the ultimate responsibility of the shift commander. The commander may require the notifications or reports be made by other Agency personnel, but the responsibility for their completeness, accuracy, and timeliness remains with the shift commander. Any report which is specifically required to be completed by the shift commander will remain a personal responsibility and shall not be delegated.

**2-305 SECTOR SUPERVISORS**

The sector supervisors shall be assigned to a shift and shall be under the direct supervision of the shift commander. The sector supervisor will report to the on-duty shift commander or, in rare instances, the on-call shift commander. The sector supervisor will be responsible for a squad of patrol officers and the patrol sector to which the supervisor and the squad are assigned.

The sector supervisor shall work closely with the officers under his control and will direct and assist them with their assignments. Within the assigned patrol sector, the sector supervisor will be responsible for providing police patrol services required of sworn officers of this Agency. They shall be aware of and perform the essential functions of a sworn officer and supervise the officers under their control in the performance of the same.

Sector supervisors will work closely with the other sector supervisors assigned to the same patrol sector. The sector supervisors assigned to the same sector will be jointly responsible for providing the best possible police services to the citizens who live or work within the geographical boundaries of the patrol sector.

Sector supervisors will assist the shift commander in fulfilling the responsibilities of the commander's position. When the shift commander is absent from the County, a sector supervisor may be assigned to act for the shift commander in the commander's absence. Therefore, sector supervisors will learn the responsibilities of the commander in order to fulfill these duties.

**2-306 PATROL DIVISION OFFICERS**

In addition to, or as enumerated by, the position description for their position, Patrol Division officers will have the following duties and responsibilities:

- patrol the County;
- seek to prevent crime;
- apprehend and process violators of the law;
- enforce motor vehicle laws and promote highway safety;
- investigate vehicle crashes;
- serve criminal and civil processes;
- render assistance to persons where health or property may be in jeopardy;
- conduct preliminary investigations of all cases where CID does not respond, to include:
  - observing all conditions, events, and remarks;
  - identifying, locating, and interviewing the complainant / victim and all witnesses;
  - maintaining, protecting, processing, or arranging for the processing of the crime scene and the collection of evidence;
  - maintaining records; and
  - preparing reports.

**2-307 TELEPHONE REPORTING FUNCTION**

The Telephone Reporting Function will be activated at the discretion of the Sheriff or his designee and will be assigned to the Commander, South Patrol Division. When activated, the function will be staffed by sworn





**Administrative and Operational Manual**

**September 12, 2022**

---

personnel on modified duty or temporarily assigned to the function. They will have the responsibility to answer calls for service by telephone for qualifying incidents. Specific procedures for officers working in this function can be located elsewhere in this manual.

## **2-350 SPECIAL OPERATIONS DIVISION (SOD)**

The Special Operations Division is that component of the Agency which provides specialized uniform police services. Special Operations Division personnel make specific law enforcement tasks their primary duty, implementing advanced training, skills, and equipment to accomplish specific Agency missions and goals.

### **2-350.1 ORGANIZATION OF THE SPECIAL OPERATIONS DIVISION**

The Special Operations Division is commanded by a sworn Captain. This Captain is responsible for all the personnel, equipment, and facilities dedicated to his command. The Division is made up of three components: Community Services Section, School Resources Section, and Field Operations Section.

### **2-351 COMMANDER, SPECIAL OPERATIONS DIVISION**

The Commander, Special Operations Division is a sworn position which shall be responsible directly to the Assistant Sheriff of Operations. He is responsible for the direct supervision of subordinate commanders and the performance of administrative duties pertaining to the daily operation of the Division. He is responsible for the performance of all personnel assigned to his command.

The Commander, Special Operations Division shall ensure the inspection of the personnel, equipment, facilities and other resources assigned to his command on a regular basis. He shall be responsible to maintain these elements of his command in compliance with the policies set forth in this Manual and in other directives of the Agency.

### **2-352 SPECIAL OPERATIONS DIVISION SECRETARY**

The Special Operations Division Secretary is a non-sworn, part-time position within the Division which reports to the Commander, Field Operations Section. The Special Operations Division Secretary's duties include administrative and clerical functions for the various sections of the Division.

### **2-360 COMMANDER, COMMUNITY SERVICES SECTION**

The Commander, Community Services Section is a sworn Lieutenant who shall be responsible to the Commander, Special Operations Division. The Commander, Community Services Section shall be responsible for the supervision and performance of the various specialized functions under his command. This component is comprised of the Community Policing (COPS) Unit, Crime Prevention Unit, Alcohol Enforcement Function, Electronic Fingerprinting Function, Community Organizer Function, Citizen Advisory Committee, Crisis Negotiations Team (CNT) Function, Special Events Response Team (SERT) Function, the Auxiliary Function and the Honor Guard Function.

### **2-361 COMMUNITY POLICING (COPS) UNIT**



**Administrative and Operational Manual**

**September 12, 2022**

The Supervisor of the Community Policing (COPS) Unit is a Sergeant who oversees the operation of the Unit and supervise the officers in performing the functions outlined in the following section. The Supervisor will report directly to the Commander, Community Services Section.

The officers assigned to the Community Policing Unit will perform specialized uniform patrol duties with an emphasis on a specific segment of the community. They will attempt to become an integral part of their assigned communities, gaining the respect and confidence of the citizens to a greater degree than may be possible in the traditional patrol officer framework.

Officers assigned to the Unit will sometimes perform non-traditional roles in solving community problems by acting as a government facilitator. Specifically, they may call upon various other components of government and the community to provide the services necessary to solve a problem which, although not strictly a law enforcement problem, may contribute to circumstances which generate criminal activities.

In general, the officers in this function will fight crime in a more comprehensive fashion because they are assigned a specific area of responsibility; provided with additional training, equipment, and resources; and are less confined in terms of their day-to-day need to respond to calls for service.

## **2-362 CRIME PREVENTION UNIT**

The Supervisor of the Crime Prevention Unit is a Sergeant who oversees the operation of the Unit and supervises the officers and civilians in performing the functions outlined in the following section. The Supervisor reports directly to the Commander, Community Services Section. The Crime Prevention Unit is comprised of sworn officers who perform the duties surrounding crime prevention, the Alcohol Enforcement Function, and the Electronic Fingerprinting Function.

The officers assigned to the Crime Prevention Unit perform specialized uniform duties with an emphasis on preventing crime through proactive engagement and education within the community.

The Crime Prevention Unit responsibilities and duties include, but are not limited to, the following:

- establishing and maintaining close relationships with leaders of the community, civic groups, religious groups, businesses, and the public in regards to preventive measures to improve the quality of life and strengthen partnerships;
- conducting meetings and presentations with said groups for the betterment of their respective situations;
- working in conjunction with the Charles County Health Department in enforcing Tobacco Laws and Health Laws;
- working in conjunction with the Board of Licensed Commissioners (BOLC) and enforcing laws, rules, and regulations, pertaining to alcohol enforcement of alcohol licensed establishments; and
- providing electronic fingerprinting services to the public regarding employment applications, background checks, etc.

### **2-362.1 ALCOHOL ENFORCEMENT FUNCTION**

The Alcohol Enforcement Function shall conduct routine alcohol inspections of all licensed liquor establishments to ensure their compliance with all federal, state, and local laws. The Alcohol Enforcement Function is a component of the Crime Prevention Unit and reports to the Supervisor, Crime Prevention Unit. The Function is comprised of a Sworn Alcohol Enforcement Officer and a civilian, part-time Alcohol Enforcement Specialist. The Function conducts investigations for alcohol and tobacco violations and submits written reports to various Agency components based on their needs.



Administrative and Operational Manual

September 12, 2022

The Alcohol Enforcement Function shall maintain liaison between the Agency and the Charles County Board of Licensed Commissioners (BOLC) and attend their meetings, in addition to attending alcohol and tobacco related citizen group meetings on behalf of the Sheriff as directed. The Function is responsible for any alcohol-related educational programs in which the CCSO may participate. The Alcohol Enforcement Function shall maintain reports, records, and monthly statistics, and perform other related duties as may be required.

## 2-362.2 ELECTRONIC FINGERPRINTING FUNCTION

The Electronic Fingerprinting Function shall be comprised of specially trained civilian personnel, who shall conduct both electronic and ink-type (rolled) fingerprinting services to customers who are members of the general public and on occasion for those employees within this Agency whose fingerprints are required for an official Agency purpose. The fingerprinting services are for the purpose of obtaining civilian based “applicant type” background checks through the Criminal Justice Information System (CJIS). In addition, the ink-type (rolled) fingerprinting services are for those persons seeking background checks for other states, or federal agencies outside the Maryland Criminal Justice Information System. These various services will be paid for by the customers either by cash, money order, debit or credit card when the appropriate mechanisms are available. The civilian personnel assigned to this Function shall be known as Electronic Fingerprint Technicians. The Technicians are either full-time or part-time and report directly to the Supervisor, Crime Prevention Unit. The location for this unit is the Charles County Sheriff’s Office Fingerprinting Center, located in the St. Charles Towne Center Mall on the second floor.

## 2-363 COMMUNITY ORGANIZER FUNCTION

The Community Organizer is a civilian employee who is responsible to the Commander, Community Services Section. This employee shall seek to enhance the Agency’s crime fighting efforts by encouraging and enabling the community of Charles County residents in their efforts to discourage, prevent, and suppress criminal activities through their own efforts and cooperation with the Agency. The Community Organizer shall work to liaison with local community organizations, businesses, places of worship, and other components of the Agency to educate, encourage, and support anti-crime efforts. This position provides a communications link between the Agency and the community.

The Community Organizer is responsible for the following:

- to regularly attend community meetings and report community concerns and suggestions for improving Agency training and practices bearing on police-community interactions to the Commander, Community Services Section;
- publication and distribution of the Watchworks Newsletter to help publicize Agency programs, objectives, problems, and successes;
- organizing the annual Agency Crime Watch Kick-off;
- organizing the annual Charles County National Night Out program;
- organizing the Citizen’s Advisory Committee meetings; and
- establishment of neighborhood Crime Watch programs.

### 2-363.1 CITIZENS ADVISORY COMMITTEE

The Commander, Community Services will establish a Citizens Advisory Committee for the purpose of distributing information to, and obtaining feedback from, the community. The Commander, Community Services and Command Staff members will represent the Agency at these meetings. The Committee itself will be made up of people from throughout the County who can speak on behalf of the various segments of the community. Members may include, but not be limited to:



**Administrative and Operational Manual**

**September 12, 2022**

- business leaders;
- church leaders;
- neighborhood watch leaders;
- representatives of civic organizations or clubs, such as Moose, Elk, Rotary, Lions, etc.;
- representatives of groups like Mothers Against Drunk Drivers, NAACP, AAA Potomac Region Driving Club, etc.;
- home owners association officers; and
- veterans groups like the American Legion, Veterans of Foreign Wars, etc.

The Commander, Community Services will make every attempt to bring together a group which generally represents the entire community, without being weighted toward a specific or limited segments of the community. As a result of the creation of, and biannual meetings with this committee, the Commander, Community Services shall be able to determine the expectations of the various constituents which make up the County, regarding Sheriff's Office services. Intelligence concerning upcoming community events will be gathered, as well as information concerning criminal activities and such other information noted by community members, which might be relevant to Agency operations.

The relative level of community satisfaction with services rendered should be a key concern of the Agency. Information gathered as a result of Citizens Advisory Committee meetings will be organized and reported in writing by the Commander, Community Services. These reports will be forwarded through the chain of command to the Sheriff. Copies of these reports, which may be of value to other components of the Agency, will be shared with these components. A copy will also be sent to the Deputy Director, Planning & Accreditation.

## **2-364 CRISIS NEGOTIATIONS TEAM (CNT) FUNCTION**

Closely related to the Emergency Services Team (EST) mission, is the Crisis Negotiations Team (CNT) Function. The CNT Coordinator for the CNT Function shall be designated by the Commander, Community Services Section. The designated Coordinator is responsible for selecting sworn personnel who meet the following minimum qualifications to be crisis negotiators:

- rank of Sergeant and below;
- three years sworn experience;
- possess excellent communication skills;
- have demonstrated maturity and good judgment under stress; and
- availability for 24-hour call-out and reasonable response time.

Personnel so selected will receive specialized training that prepares them to perform their responsibilities and will participate, with EST and other elements of the Agency, in mock training exercises designed to hone their skills as negotiators. All training for negotiators will be scheduled by the designated Coordinator.

Crisis negotiators will have regular assignments throughout the Agency, but will respond to situations requiring their talents and training when the need is present. They will also participate in scheduled training as necessary. When training with EST, or working a real event, they will be under the command of the Commander, Community Services Section or the on-scene commander for the situation or event requiring a response.

In all cases, except when fulfilling their function as crisis negotiators, or when performing in a scheduled training exercise, these employees will be responsible to their assigned chain of command. With regard to their actual response to events, or participation in scheduled training exercises, they will be responsible to the Commander, Community Services Section. The Commander, Community Services Section or Coordinator will provide as much advance notice as possible to the employee's normally assigned chain of command of the need for the employee to respond to an event. In the case of scheduled training exercises, at least two weeks' notice will be provided. The normal chain of command of crisis negotiators will cooperate fully with the Commander, Community Services



Administrative and Operational Manual

September 12, 2022

Section and Coordinator in supporting these employees to provide crisis negotiation services for the Agency.

## 2-365 SPECIAL EVENT RESPONSE TEAM (SERT) FUNCTION

The Commander, Community Services Section is designated as the Special Event Response Team Commander and shall command and direct all SERT related activities. The Special Event Response Team provides the Charles County Sheriff's Office with the capability to appropriately respond to large public gatherings, demonstrations, disturbances, or other public safety activities, such as search and rescue missions and executive protection details. The trained personnel can ensure a highly organized, disciplined response to any spontaneous incident or unusual occurrence that places undue demand on patrol officers within their respective districts. The SERT will be composed of officers with various regular assignments within the Charles County Sheriff's Office. The officers will be broken down into operational squads, a logistical squad, and relief officers. Each squad is supervised by a Sergeant.

## 2-366 AUXILIARY FUNCTION

The Auxiliary Volunteer Program provides voluntary personnel who have successfully completed the Citizen's Police Academy, under the authority of the Sheriff, an opportunity to apply their training to augment public safety community outreach efforts.

Volunteers offer their services to assist the Agency in law enforcement-related community service functions, and perform specific duties without any financial compensation from the County. They are permitted to perform only specifically authorized duties.

To be considered for service as an Auxiliary Volunteer, the candidate must successfully complete the Charles County Sheriff's Office Citizen's Police Academy and be endorsed by the Commander, Community Services Section. Auxiliary Volunteers are required to complete a background check and remain in good standing with the Charles County Sheriff's Office.

Auxiliary members are not sworn police personnel and do not have arrest powers, nor will they be assigned to duties requiring sworn police officer status. Members will not be allowed to operate Agency vehicles. Unless specifically authorized by the Sheriff, they will not carry weapons of any type.

Volunteers will be issued a polo style shirt of a design authorized by the Sheriff that clearly designates the volunteer as such. For the safety of the volunteers, a police style uniform will not be issued.

Auxiliary members serve at the pleasure of the Sheriff, but report directly to the Commander, Community Services Section.

## 2-367 HONOR GUARD FUNCTION

The Honor Guard Function is a function of the Special Operations Division; however, both sworn and correctional officers within the Agency may be assigned to the Function. The Honor Guard Commander is a duty assigned to the Commander, Community Services Section, who will select a Sergeant as Honor Guard Coordinator to assist in Honor Guard operations. The Honor Guard function is to assist families of fallen officers at funerals when requested and serve as a community relations link by performing at various events in and out of Charles County in accordance with policy found elsewhere in this Manual.



Administrative and Operational Manual

September 12, 2022

## **2-370 SCHOOL RESOURCES SECTION COMMANDER**

The Commander, School Resources Section is a sworn Lieutenant who shall be responsible to the Commander, Special Operations Division. The Commander shall be responsible for the supervision and performance of the various specialized functions under his command. This component is comprised of the School Resources Units, the Criminal Justice Program Function, the School Crossing Guard Function, the Explorer's Post #1658 Program, the Teen Court Function and the Search Management Function.

## **2-371 SCHOOL RESOURCES UNITS**

The School Resources Units, each supervised by a Sergeant, will develop comprehensive strategies and associated programs designed to reduce juvenile crime and delinquency. In conjunction with this primary goal, the Units will foster activities, which are aimed at supporting target youth populations who have been determined to have a propensity for becoming involved in criminal or antisocial behavior, and may eventually make them subjects of Agency enforcement activities. Although this policy provides specific guidelines for the School Resources Units, the responsibility for participating in or supporting the Agency's juvenile operations will continue to be shared by all components and employees of the Agency.

These Units will create and nurture working relationships with other components and employees of this Agency, as well as relationships with citizen groups, schools and other juvenile justice agencies, in order to accomplish its mission and goals. These Units will develop lines of communication with youth groups and organizations in order to better understand their needs and problems. These Units will become a clearinghouse for knowledge of what works and what does not work in the support of youth toward a life of productive citizenship within the community. These Units will use this knowledge to marshal the resources of the community and the Agency to prevent juvenile crime and delinquency.

Members of these Units will present school-based prevention programs that include "Safe Schools," "Truth and Consequences," and D.A.R.E. (Drug Abuse Resistance Education).

These Units will gather and use statistical data in order to evaluate their performance and success or failure. This cooperative effort will continually refine the data to make it more meaningful in pursuing the mission and goals of the Units.

These Units will share information gathered with other components of the Agency, both on a regular basis and through the development of training programs designed to allow other component personnel to benefit from the specialized interaction of these Units and the youth community. To the degree possible, without compromising the Agency's mission, information will be shared with the community at large and the youth community, in order to further the purpose of supporting youth in their efforts to remain crime and delinquency free.

### **2-371.1 CRIMINAL JUSTICE PROGRAM FUNCTION**

The Criminal Justice Program is a cooperative effort of the Charles County Sheriff's Office and the Charles County Public School System. This program is designed to allow high school students the opportunity to become familiar with the Criminal Justice System and the Charles County Sheriff's Office operation specifically. As a result of this program, the student may be in a better position to decide to enter a career as a Charles County Sheriff's Office employee or enter some other component of the Criminal Justice System. The Criminal Justice Program is coordinated by the Criminal Justice Program Instructor.

#### **2-371.1.1 EXPLORER POST #1658 PROGRAM**

Explorer Post #1658, a subsidiary of the Boy Scouts of America (BSA) organization, is sponsored by the Charles County Sheriff's Office, and is overseen by the Commander, School Resources Section. The Commander, School



**Administrative and Operational Manual**

**September 12, 2022**

Resources Section shall appoint members of the Agency to act as the Explorer Post Advisor and Assistant Explorer Post Advisor(s). The Advisor and Assistant Advisor have the responsibility to oversee the daily operations of the Post. The Post is made up of young men and women ranging in age from 14 to 21 years old who have an interest in the law enforcement profession.

Explorers assigned to Post #1658 are volunteers and are in no way considered employees of the Charles County Sheriff's Office. Explorers must meet minimum standards and abide by the Constitution and By-Laws of the Post to remain in the Post.

**2-371.2 SCHOOL CROSSING GUARDS FUNCTION**

School Crossing Guards are part-time, non-sworn positions. The School Crossing Guards shall assist school children across the highway at designated school crossings and assist school buses entering or leaving the highway at designated locations. School Crossing Guards are directly responsible to the Supervisors, School Resources Units.

**2-372 TEEN COURT FUNCTION**

Teen Court is designed to reduce the number of youthful offenders and educate community youth in a realistic court environment. Teen Court is a juvenile justice diversion program offering first-time offenders, ages 7-17, the opportunity to accept accountability for their minor crimes without having to incur a criminal record. Teen Court is a voluntary program that allows juvenile respondents to be judged by a jury of their peers. Teen Court is conducted in an actual court-like setting in pre-established community-based locations with the teens acting as prosecutors, defense attorneys and jury members in each case. The sanctions consist of community service projects, enrollment in applicable education programs, and mandatory jury duty in other Teen Court cases. This mission is carried out by sworn officers and civilians staff, by conducting Teen Court in a community setting and through cooperative efforts of the juvenile justice administration, school administrators, community leaders, volunteers and the Agency.

**2-373 SEARCH MANAGEMENT FUNCTION**

The Search Management Function provides highly trained supervisors and administrators to manage the planning and operations of critical missing person and manhunt searches. These individuals, using Lost Person Theory as the basis for their decision-making process, will provide incident commanders with the information necessary to guide field operations in cases where the search for an individual is critically needed to save life or protect the public from a fleeing suspect.

**2-380 COMMANDER, FIELD OPERATIONS SECTION**

The Commander, Field Operations Section is a sworn Lieutenant who shall be responsible to the Commander, Special Operations Division. The Commander, Field Operations Section shall be responsible for the supervision and performance of the various specialized functions under his command. This component is comprised of the Traffic Operations Unit, Automated Enforcement Function, Intoximeter Operator Function, Emergency Services Team Function, K-9 Function, Security Response Vessel Function, Unmanned Aerial System Function, Drug Recognition Expert Function, and the Motorcycle Function.

**2-381 TRAFFIC OPERATIONS UNIT**



**Administrative and Operational Manual**

**September 12, 2022**

The Supervisor of Traffic Operations is a Sergeant who shall report directly to the Commander, Field Operations Section. He shall be responsible primarily for specialized patrol which is aimed at the improvement of highway safety and crash prevention. The Traffic Operations Supervisor shall have responsibility for the everyday operation of the Unit, which consists of other Traffic Operations officers.

Additionally, the Traffic Operations Supervisor shall be responsible for the following:

- motorcycle component;
- supervising the investigation of fatal and serious injury crashes;
- supervising the investigation of school bus crashes;
- the administration and supervision of the Agency Commercial Vehicle Enforcement component;
- Automated Enforcement Function;
- Charles County Tow Permit Program;
- Charles County Sheriff's Office Authorized Tow Services Program (ATSP);
- Charles County Sheriff's Office Intoximeter Program;
- the coordination of all grants provided to the Charles County Sheriff's Office for traffic enforcement or related programs;
- the coordination of all funeral escort services; and
- supervising the response to traffic complaints and speed analysis requests.

The Supervisor shall prepare reports, maintain records, conduct investigations, and perform other related work as may be required.

**2-381.1 AUTOMATED ENFORCEMENT FUNCTION**

The Automated Enforcement Function (AEF) is comprised of civilian Automated Enforcement Unit Office Specialists and one sworn Automated Enforcement Officer with arrest powers limited by the Sheriff, Charles County. Employees of the Function report to the Supervisor, Traffic Operations Unit.

The AEF is responsible for the processing of automated citations generated by speed cameras and red light cameras placed throughout Charles County by contracted vendors. Additionally, employees of the AEF field customer service telephone calls, process court paper work, research vehicle information and testify in court proceedings relative to the citations issued by automated camera systems within Charles County.

**2-381.2 INTOXIMETER OPERATOR FUNCTION**

The Intoximeter Operators are assigned to the Patrol Division. Each operator shall maintain at his assigned station an Intoximeter Operator's Log (MSP Form 36A).

All tests conducted by that operator (defendant tests and simulator tests) shall be recorded in the log as soon as practical. These tests must also be recorded in the appropriate Log of Tests for Alcohol Influence Arrests (MSP Form 36B).

Each operator is required to run a minimum of one (1) test per month, either subject test or simulation; four (4) subject tests are also required per year. These will be listed on the Operator's log. Special exceptions to this regulation will be allowed because of sick and safe leave, annual vacation, temporary assignment outside of the area, or the absence of the instrument due to repairs. The reason for failing to perform the required tests will be entered on the Intoximeter Operator's log.

The Operator's log will be maintained by the operator for the purposes of establishing a permanent record of his testing experience in court.





Administrative and Operational Manual

September 12, 2022

---

## 2-382 EMERGENCY SERVICES TEAM (EST) FUNCTION

The various duties and functions of the Emergency Services Team (EST) shall be coordinated by the Commander, Field Operations Section who is designated as the Commander, Emergency Services Team. The duties and functions of the Emergency Services Team include:

- handling high-risk situations, including hostage incidents, barricaded persons incidents, sniper situations, or other similar situations;
- assisting in the execution of search and seizure warrants and certain arrest warrants in which the presence of the Emergency Services Team is considered to be appropriate;
- performing selected assignments and stakeout operations in situations in which there may be an inherent danger of armed confrontations calling for the use of specialized weapons or tactics;
- maintaining the required level of readiness through the implementation of extensive training programs of physical fitness, marksmanship, rappelling, and other skills related to the EST mission; and
- maintaining a dialog with Patrol, Criminal Investigations and other operational components concerning the interaction of EST and these components, both during an incident and by their involvement in training exercises.

## 2-383 K-9 FUNCTION

The K-9 Function shall be coordinated by the Commander, Field Operations Section.

K-9 officers will be assigned to a daily shift with other patrol officers. While they are working a normal tour of duty, they will be under the operational supervision of the district supervisors of the squad to which they are assigned. The K-9 officer shall perform in the capacity of a public safety officer with the primary responsibility of K-9 patrol. K-9 officers will utilize their police K-9s for suspect apprehension, narcotics detection, humanitarian and criminal searches, explosives detection and firearms detection. K-9 officers will attend formal K-9 training and maintain all necessary certifications.

K-9 officers assigned to the Patrol Division as a patrol officer should not normally be utilized for calls for service requiring advanced or extended investigations, traffic crashes, and criminal arrests requiring the transport and processing of prisoners, or on prolonged incidents.

## 2-384 SECURITY RESPONSE VESSEL (SRV) FUNCTION

The SRV Function shall be coordinated by the Commander, Field Operations Section. The primary function of the SRV is to provide waterway security patrols during times of heightened terrorism threat levels as assigned by the U.S. Department of Homeland Security, provide law enforcement in a marine environment, and other duties as deemed appropriate and authorized by the Commander, Field Operations Section. Officers assigned to the SRV Function may be assigned to other divisions from the Agency; however, they will respond when the deployment of the vessel is necessary. The duties of officers and purpose of this function are found in the SRV Standard Operating Procedures (SOP).

## 2-385 UNMANNED AERIAL SYSTEMS (UAS) FUNCTION

The Unmanned Aerial Systems (UAS) Function shall be coordinated by the Commander, Field Operations Section. The UAS Function is responsible for piloted or autonomous unmanned aircraft flights for the Charles County Sheriff's Office. Unmanned aircraft, commonly called "drones," are used to accomplish an aerial law enforcement purpose for the Agency. The UAS Function consists of sworn police officers, correctional officers,



Administrative and Operational Manual

September 12, 2022

and identified civilian Agency employees who have completed the necessary training, and achieved the necessary Federal Aviation Administration (FAA) certifications to operate as a commercial drone pilot. The UAS Function utilizes unmanned aircraft for aerial photography, surveillance, suspect identification, search and rescue, or other similar law enforcement purposes. The UAS Function may be deployed as a visible deterrent in high crime areas or in a first-responder function. The use of the unmanned aircraft, and additional requirements of the pilots, is governed by the UAS SOP.

A UAS Coordinator, appointed by the Commander, Field Operations, is responsible for the training of new pilots, maintenance of agency UAS equipment, the coordination and documentation of continuing pilot training and the overall functions of the Function. The UAS Coordinator, when acting in such a capacity, will report to the Commander, Field Operations Section.

### **2-386 DRUG RECOGNITION EXPERT (DRE) FUNCTION**

The Drug Recognition Expert (DRE) Function falls under the Commander, Field Operations Section. A DRE is a sworn police officer, who is certified to administer a Drug Influence Evaluation on a subject suspected to be under the influence and/or impaired by drug(s). This is typically done, but not limited to, when a subject has been arrested for DUI, and alcohol impairment has been ruled out. A DRE must be Standardized Field Sobriety Tests (SFST) and Advanced Roadside Impaired Driving Enforcement (ARIDE) certified. A DRE is trained, certified, and endorsed through the Maryland Highway Safety Office, the Maryland State Police (MSP), the International Association of Chiefs of Police (IACP), and the National Highway Traffic Safety Administration (NHTSA). The Drug Recognition Expert (DRE) Agency Coordinator reports to the Commander, Field Operations and the MSP DRE State Coordinator. The DRE Agency Coordinator must be certified as a DRE Instructor and sanctioned by the Maryland State Police (MSP) DRE State Coordinator and Commander, Field Operations as such. The DRE Agency Coordinator is responsible for the integrity of the DRE Program for the Charles County Sheriff's Office (CCSO) and the La Plata Police Department (LPPD). The DRE Agency Coordinator supervises DRE's for CCSO and LPPD, and maintains records of DRE evaluations, certifications, trainings, and policy within the DRE SOP.

### **2-387 MOTORCYCLE FUNCTION**

The Supervisor, Traffic Operations Unit shall coordinate the use of Agency motorcycles. Only those officers who have completed the Basic Motor Officer Certification course, or who are training under the supervision of an instructor, will operate Agency motorcycles. Officers assigned to the Traffic Operations Unit who have completed the Basic Motor Officer Certification Course will be assigned an Agency motorcycle during their tenure in the Unit. Officers who are assigned to the Motorcycle Function as a collateral duty will not be assigned an Agency motorcycle. Rather, the Supervisor, Traffic Operations will ensure a fleet of motorcycles is available for use by collateral motor officers. Agency motorcycle officers will adhere to the policies and procedures as outlined in the Motorcycle Function SOP. Agency motorcycles will be used for traffic enforcement, crash investigation and the escort of funeral processions for other motor vehicle(s). Unless specifically directed by the Supervisor, Traffic Operations, the Agency motorcycle may be utilized for operations throughout Charles County without limitation.

### **2-400 CRIMINAL INVESTIGATIONS DIVISION (CID)**

The Criminal Investigations Division (CID) is organized to handle complex investigations which require significant time, technical investigative expertise, investigative resource networks, flexible manpower assignment, or a combination of these factors. Certain cases will almost always fulfill these requirements and are, therefore, made the responsibility of CID. Other cases are sometimes easily handled by other Agency personnel and are, therefore, optionally the responsibility of CID.

CID may act in a support role in criminal investigations handled by other components of the Agency, by providing crime scene processing, assistance with interviews and interrogations, and by providing help with other technical



**Administrative and Operational Manual**

**September 12, 2022**

matters or sources of information. The determination to assume responsibility of an investigation in those cases where there is an option, is generally made by a CID detective in response to a request for assistance. In some cases, when an initial report written by another component of the Agency is reviewed by a CID supervisor, the supervisor may decide the case warrants assignment to a CID detective.

CID will have the responsibility to investigate the crimes listed in Chapter 2, Section 400.1. However, this does not imply detectives will be responsible for initial reports, responding to all crime scenes, or calls for service to these crimes. Whenever practical, detectives will respond to scenes of these crimes to assist until the case is formally assigned. In some cases, detectives will write initial reports, even though other officers have initially responded to the scene. Nothing in this policy prohibits members of any other division from conducting investigations into, or from making arrests for, the enumerated crimes prior to the assumption of an investigation by Criminal Investigations Division personnel.

Sworn positions within CID have the same rank, title, and salary schedule as equivalent sworn positions throughout the Agency.

Criminal Investigations is divided into five sections: Persons Crimes, Property Crimes, Homeland Security, Forensic Science and Narcotics Enforcement. Each section has responsibilities and duties based on the scope and types of crimes they investigate.

## **2-401 CRIMES INVESTIGATED BY CID**

- deaths (unless natural);
- shootings (unless accidental);
- officer-involved critical incidents resulting in death or serious physical injury;
- felony assault (life threatening or severe injuries);
- rape;
- sexual offense (except fourth degree);
- robbery;
- kidnapping / abduction;
- child abuse;
- elderly abuse;
- critical missing persons;
- burglary;
- forgery and related crimes;
- credit card fraud;
- CDS;
- violations of narcotics and vice laws;
- terrorism;
- threats of mass violence;
- criminal gang activity;
- follow-up investigations of reports by officers as approved / assigned;
- cold case incidents;
- special investigations assigned by the Sheriff or Assistant Sheriff.

## **2-402 COMMANDER, CRIMINAL INVESTIGATIONS DIVISION**

The Commander shall be responsible directly to the Assistant Sheriff of Operations for all matters pertaining to the Criminal Investigations Division. The Commander is responsible for the administration of all the personnel assigned to the command. The Commander shall:

- develop programs and policies which foster close cooperation between CID personnel and other personnel within the CCSO; and



**Administrative and Operational Manual**

**September 12, 2022**

- develop policies to ensure criminal investigations are conducted properly and prepared for presentation before the courts; and
- provide personnel and resources assigned to CID for response to crime scenes and requests for assistance; and
- assist other law enforcement agencies with ongoing criminal investigations; and
- provide methods for the exchange of information between the CCSO and other law enforcement agencies in matters of mutual interest; and
- evaluate the methods of operation of CID and make recommendations for its improvement; and
- train subordinate personnel in the operation and management of CID; and
- inspect or cause to be inspected all personnel and equipment under his command on a periodic basis.

**2-403 UNIT SUPERVISOR'S RESPONSIBILITIES**

Unit Supervisors within CID will have the following general responsibilities:

- fulfillment of all Unit responsibilities;
- supervision of Unit personnel;
- ensuring maintenance of all equipment and office space assigned to the Unit;
- inspection of personnel, equipment, uniforms, office and storage space, and vehicles assigned to the Unit or its personnel;
- maintaining a general knowledge of the other units' responsibilities, investigations, and personnel;
- assumption of the role of Section Commander in the absence of the Commander, in accordance with the roster developed by the Commander for this purpose;
- reviewing all Unit search and seizure warrant applications prior to submission to the State's Attorney's Office, if appropriate;
- review and approval of operational plans for all Unit special operations and search warrants;
- such other duties as may be specifically assigned by the Commander.

**2-404 DETECTIVES' RESPONSIBILITIES**

Detectives assigned to CID shall investigate crimes, examine evidence, apprehend violators of the law, maintain records, prepare reports, and perform other work-related duties as assigned or required. They shall maintain a level of expertise in the field of investigations which is generally above that of the other sworn members of the Agency not assigned to an investigative function.

In this regard, they will read and know the criminal law which applies to the various cases which they are charged to investigate. They will be aware of current case law as it pertains to their cases. They will read text books and



**Administrative and Operational Manual**

**September 12, 2022**

periodicals which apply to their chosen field of investigations. They will become expert as investigators in order that they may be recognized and testify as such in court.

Detectives shall provide such assistance and support as may be needed to the patrol units of the Agency. They will strive to maintain a working relationship with the patrol function to the benefit of CID, Patrol, and the Agency. They will attend patrol roll calls, when possible, and share information with patrol officers in support of the patrol and investigations functions.

## **2-405      COMMANDER, PERSONS CRIMES SECTION**

The Commander, Persons Crimes Section is a sworn Lieutenant who reports directly to the Commander, CID. This Commander is responsible for the administration and operation of the Section, which includes the following units:

- Major Crimes Unit (MCU);
- Special Victims Unit (SVU);
- Robbery Unit (RU);
- Digital Forensics Unit (DFU).

The Commander shall ensure that all the responsibilities of the various units comprising this section are handled in the most efficient and effective manner possible. The Commander will ensure that the various functions are manned in a manner which provides support to the Agency patrol function while providing for the necessary investigation of the cases currently active within the Persons Crimes Section.

The Commander will maintain an awareness of the current workloads of the various units within his section and adjust assignments to compensate for uneven workloads. The Commander will be aware of any major investigations currently under way within his units and ensure that the Commander, Criminal Investigations Division is kept apprised of the status and progress of such cases.

The Commander, Persons Crimes Section will keep himself informed with regard to all the functions of the Criminal Investigations Division through close cooperation with the Commander, Property Crimes Section; Commander, Narcotics Enforcement Section; the Commander, Homeland Security Section; and the Division Commander. The Commander, Persons Crimes Section will assume the responsibilities of the Division Commander in his absence.

### **2-405.1      MAJOR CRIMES UNIT**

The Major Crimes Unit shall have the responsibility for the investigation of cases involving:

- deaths (unless attended natural);
- shootings (except accidental);
- felony assault with life threatening or severe injuries;
- critical missing person;
- kidnapping / abduction;
- cold case incidents;
- officer involved shootings / critical incidents;
- any case specifically assigned.

The Unit will conduct missing persons investigations, providing immediate response, at the request of the Patrol operations commander / shift commander / sector supervisor, to the scene of a critical missing person. The Unit will conduct an investigation of non-critical missing persons if the person has been reported missing for more than ten (10) days. All missing persons investigations will comply with the provisions of other applicable sections of the AOM.



Administrative and Operational Manual

September 12, 2022

## 2-405.2 SPECIAL VICTIMS UNIT

The Special Victims Unit shall be responsible for the investigation of the following crimes and incidents:

- physical / sexual child abuse;
- child deaths;
- vulnerable adult abuse;
- rape;
- sexual offenses (except fourth degree);
- maintaining Sex Offender Registry list for Charles County; and
- other cases as assigned.

Personnel of this Unit will be familiar with and conduct investigations consistent with the policy found in Chapter 4, Sections 704-705 of the AOM. The Unit will act in cooperation with the Department of Social Services and Protective Services in the conduct of the Unit's investigative responsibilities.

### 2-405.2.1 COMFORT CANINE FUNCTION

The Comfort Canine Program was established to assist the Sheriff's Office in providing comfort to victims and witnesses of various crimes. The primary goal of this program is to assist detectives during forensic interviews with child victims and additionally to assist these victims when testifying in criminal court cases. Secondly this program can assist both sworn and civilian employees with stress relief.

The CID Special Victims Unit (SVU) Supervisor will be responsible for the direct supervision of the Comfort Canine Program. The SVU Supervisor will maintain a training and veterinary log for any canine in the program. Individual handlers will be responsible for monthly submissions of any training received or programs/events attended. See the Comfort Canine SOP for the full details of this program.

## 2-405.3 ROBBERY UNIT

The Robbery Unit shall be responsible for the investigation of serious robbery cases. This shall include but is not limited to:

- Commercial Armed Robberies
- Citizen Armed Robberies
- Carjackings
- Other Cases as assigned

## 2-405.4 DIGITAL FORENSICS UNIT

The Digital Forensics Unit (DFU) is a highly technical and specialized group with diverse functions and responsibilities. The Unit's primary mission is the identification, recovery and analysis of digital evidence leading to the professional processing, documentation and subsequent court presentation of findings. The DFU provides the Sheriff's Office with a resource for the identification and recovery of digital evidence from hardware, media and devices containing digital evidence by conducting objective forensic analysis consistent with the Charles County Sheriff's Office policies and Maryland State and Federal Laws.

See the Digital Forensic Unit SOP for the full details of this program.



Administrative and Operational Manual

September 12, 2022

---

## 2-406 PROPERTY CRIMES SECTION

The Commander, Property Crimes Section is a sworn Lieutenant who reports directly to the Commander, CID. This Commander is responsible for the administration and operation of the Section, which includes the following units:

- Property Crimes Unit
- Financial Crimes Unit
- Victim/Witness Services Function

The Commander shall ensure that all the responsibilities of the various units comprising this section are handled in the most efficient and effective manner possible. The Commander will ensure that the various functions are staffed in a manner which provides support to the Agency patrol function while providing for the necessary investigation of the cases currently active within the Property Crimes Section.

The Commander will maintain an awareness of the current workloads of the various units within his section and adjust assignments to compensate for uneven workloads. The Commander will be aware of any major investigations currently under way within his units and ensure that the Commander, Criminal Investigations Division is kept apprised of the status and progress of such cases.

The Commander, Property Crimes Section will keep himself informed with regard to all the functions of the Criminal Investigations Division through close cooperation with the Commander, Persons Crimes Section; Commander, Narcotics Enforcement Section; the Commander, Homeland Security Section; and the Division Commander.

### 2-406.1 PROPERTY CRIMES UNIT

The Property Crimes Unit shall have the responsibility for the investigation of cases involving:

- commercial burglaries;
- residential burglaries;
- some felony thefts; and
- any case specifically assigned.

### 2-406.2 FINANCIAL CRIMES UNIT

The Financial Crimes Unit shall have the responsibility for the investigation of cases involving:

- identity theft;
- forgery and related crimes;
- credit card fraud;
- pawn violations;
- auto theft;
- continuing criminal fraud/embezzlement schemes; and
- any case specifically assigned.

Detectives will be assigned to the Auto Theft Detail of this Unit based on their particular expertise and training in the investigation of these types of crimes. The detectives will specialize and concentrate their efforts in the investigation of auto thefts as well as coordinating their efforts with investigators of surrounding jurisdictions who have a similar specialized investigative function.

The auto theft investigators shall provide assistance to Agency personnel in identifying vehicles with missing, altered, damaged, or obliterated identification numbers. These investigators will also aid in the identification of vehicle parts which have altered, missing, damaged, or obliterated identification numbers.



Administrative and Operational Manual

September 12, 2022

Sworn officers of this Agency may verify vehicle identification numbers (VINs) only if there is no evidence of the number having been tampered with. If there is any question about the validity of a VIN, the matter shall be referred to an Auto Theft detective. Certificates of authority to dispose of abandoned vehicles will be issued by the Traffic Operations Unit.

The auto theft investigators shall maintain specialized files regarding auto theft trends and statistics and concentrate their efforts based upon the information gained from these files. They will maintain liaison with the various insurance companies and lending institutions which have an interest in auto theft. Auto Theft investigators will be responsible for educating the public regarding ways to reduce and/or prevent the theft of motor vehicles.

### 2-406.3 VICTIM / WITNESS SERVICES FUNCTION

The Victim / Witness Services Function is tasked with providing support to victims / witnesses of crimes through the use of available support programs. In this regard, the Function will be fully aware of all federal, state, and privately funded programs aimed at the support of victims / witnesses of crime. The Function will maintain a supply of documents created by these entities for distribution to victims / witnesses. The Function will maintain telephone numbers, addresses, and names of contact persons for all of these available resources, as well as awareness of available online resources for victims and witnesses.

The Function will make contact with victims of Part One crimes to determine their satisfaction with the Agency response to the crime of which they were a victim. The Function will bring to the attention of appropriate Agency management personnel any legitimate shortfall in Agency service to victims / witnesses. Agency managers and administrators will be responsible for rectifying these discrepancies in service, if possible.

In addition to coordinating the level of satisfaction the victim / witness has with Agency service, the Function will attempt to provide referrals to available services which may mitigate the impact of crime upon the victim / witness. These services may include, but are not limited to:

- housing;
- support groups;
- counseling;
- financial or other restitution;
- legal aid;
- medical treatment; and
- explanation and guidance through the criminal justice system process through coordination with the Victim/Witness Unit of the State's Attorney's Office, or other allied Agencies.
- explanation of Crime Victim's Rights.

### 2-407 COMMANDER, NARCOTICS ENFORCEMENT SECTION

The Commander, Narcotics Enforcement Section is a sworn Lieutenant who reports directly to the Commander, Criminal Investigations Division. The Narcotics Enforcement Commander is responsible for the administration and operation of the Section, which includes the following units:

- Street Narcotics Enforcement
- Major Narcotics
- Administrative Drug Analyst

The Commander shall ensure that all the responsibilities of the various units comprising this section are handled in the most efficient and effective manner possible. The Commander will ensure that the units under his command are adequately staffed to provide support to the Agency patrol function while providing for the necessary investigation of the cases currently active within this Section. The Commander will maintain an awareness of the





**Administrative and Operational Manual**

**September 12, 2022**

current workloads of the various units within the section and adjust assignments as needed to compensate for uneven workloads. The Commander will be aware of all current major investigations within the section and ensure that the Commander, Criminal Investigations Division is kept apprised of the status and progress of such cases.

The Commander, Narcotics Enforcement Section will, through close cooperation with the Commander, Persons Crimes Section; the Commander, Property Crimes Section; the Commander, Homeland Security Section; and the Division Commander, keep himself informed with regard to all the functions of the Criminal Investigations Division.

**2-407.1 STREET NARCOTICS ENFORCEMENT UNIT**

The Street Narcotics Enforcement Unit will conduct initial and follow-up investigations of cases involving:

- Narcotics violations;
- Vice laws;
- Gambling laws; and
- Other cases as assigned.

Detectives assigned to this Unit will provide assistance to other Agency officers in handling cases requiring the expertise of the Unit's investigators.

**2-407.2 MAJOR NARCOTICS UNIT**

The Major Narcotics Unit will be responsible for the investigation and dismantling of the highest level drug trafficking organizations. This may include drug conspiracy cases and cases involving participation with or high-level interaction with state and federal agencies. In general, these cases, by their nature, are of a longer duration and will require greater expertise and technical investigative methods, including conducting in-depth financial analysis. Asset seizure and tax fraud are often a major part of these investigations. This Unit will also be responsible for any cases presented to or brought from other agencies involving conspiracy investigations.

**2-407.3 HIGH INTENSITY DRUG TRAFFICKING AREA - HIDTA**

The Narcotics Enforcement Section will assign a detective to the Washington / Baltimore HIDTA group. The detective will coordinate investigations with HIDTA and the Charles County Sheriff's Office. The detective shall adhere to the rules and regulations of HIDTA and the Charles County Sheriff's Office. The Charles County Sheriff's Office Major Narcotics Unit Supervisor shall have the responsibility of evaluating the detective, with input from the HIDTA supervisor.

**2-407.4 ADMINISTRATIVE DRUG ANALYST**

The Narcotics Enforcement Section will have a full-time civilian Administrative Drug Analyst who will perform a variety of administrative and clerical duties relative to the operation of the CID Narcotics Enforcement Section, and associated details/functions. This position also performs specialized tasks in developing case specific intelligence and information in the identification of person(s) involved in drug trafficking organizations. The Administrative Drug Analyst also utilizes various in-house databases and external database sources to create, manage, and organize comprehensive analytical reports and/or investigative assistance to the Narcotics Enforcement Section. Additionally, the Administrative Drug Analyst will be trained in the extraction of data from cell phones and other electronic devices to assist sworn officers from all divisions with drug investigations involving those devices. The employee receives general supervision from, and reports directly to, the Commander, Narcotics Enforcement Section.

**2-408 HOMELAND SECURITY AND INTELLIGENCE SECTION**

The Section is commanded by a sworn Lieutenant who is directly responsible to the Commander, Criminal



**Administrative and Operational Manual**

**September 12, 2022**

Investigations Division. The Section Commander is responsible for the administration and operation of the Section, which includes the following units:

- Firearms Investigation Unit (FIU)
- Crime Analysis Function

Because of the critical nature of information gathered and managed by this command, the Section Commander will develop and manage methods of communication with all entities associated with this Command's responsibilities. Information of a nature which might require immediate action on the part of the Agency will be relayed to the Commander, Criminal Investigations Division as soon as it is received; and in the absence of the Commander, Criminal Investigations Division, to the Assistant Sheriff of Operations or the Sheriff, directly. In the event the Commander, Homeland Security and Intelligence Section may be temporarily unavailable to receive and transmit critical information (leave, out-of-town training, etc.), he will develop arrangements to provide a temporary link for information to flow up the chain of command during his absence.

This Section gathers intelligence information through the cooperative efforts of Agency personnel and partner agencies at the local, state, and federal level. Partner agencies can cover a wide variety of disciplines, as the nature of the work in the Homeland Security and Intelligence Section is embedded in the disciplines of intelligence gathering, emergency management, criminal investigations, homeland security preparedness, and, data mining, and crime analytics.

The Section maintains liaison with counterpart components of other agencies as necessary to gather such intelligence information as may be available through such sources for the benefit of the Agency and the citizens of Charles County. The Section shall make such reports as are necessary to keep the Sheriff informed concerning organized crime, hate groups, outlaw motorcycle gangs, youth gangs, terrorist organizations, and any other organized effort of an illegal nature or which poses a significant danger to the safety and well-being of the citizens of Charles County. No less than once each year, an annual summation of the activities of all identified groups which are the proper subject of the Section's activities, and any isolated incidents not associated with a particular group, will be compiled and presented to the Sheriff. This report will be closely protected from unauthorized disclosure and is for the exclusive use of the Sheriff. Within this document, recommendations will be made concerning the strategies for defending against the continuing future activities which are the subject of the report. The Sheriff will use this document in determining resource allocation to combat the subject activities. The report will be due January 31 of each year and will cover the previous calendar year's activities.

The Section maintains intelligence information that is limited to criminal conduct or to activities that present a threat to the community, and which is of a confidential and sensitive nature, and which could not otherwise be maintained within the general or investigative files of the Agency. All files, records, and documents maintained by the Homeland Security Section are stored and managed in full compliance with Code of Federal Regulations 28 (CFR28).

All intelligence files will be maintained in a secure fashion, separate from any other Agency files. These files will be accessed only on a need-to-know basis with access strictly controlled, monitored, and documented in a manner designed to protect against unauthorized disclosure or destruction of the information contained within them. This Section will be utilized in their special capacity, either acting exclusive of other components of the Agency on specialized investigations or projects of an extremely sensitive nature or in concert with other components of the Agency when specialized equipment or techniques are not available within the other components supported.

The personnel in the Homeland Security and Intelligence Section will be drawn from Agency members and local representatives of other law enforcement agencies. The local representatives will serve as "liaison officers" to their respective agencies. The officers will answer directly to the Commander, Homeland Security and Intelligence Section.

## **2-408.1 EMERGENCY MANAGEMENT AND HOMELAND SECURITY**

The Commander, Homeland Security and Intelligence Section acts as the Agency's Emergency Manager. This



Administrative and Operational Manual

September 12, 2022

employee will obtain and maintain the necessary federal security clearances needed to access any information required and maintained in regard to their position.

The Commander, Homeland Security and Intelligence Section will be responsible for interaction with allied law enforcement and all other agencies who share this Agency's responsibility for Homeland Security and Emergency Management. These agencies include the:

- Department of Homeland Security (state and federal), i.e., FEMA & MEMA;
- Charles County Department of Emergency Management;
- Local Emergency Planning Center;
- Maryland Coordination and Analysis Center - MCAC;
- Joint Terrorism Task Force - JTTF;
- Federal Bureau of Investigation - FBI;
- County Emergency Operations Center (during a declared state of emergency).

The Commander, Homeland Security and Intelligence Section will be responsible for securing Agency staffing for any named agencies and/or task forces. This will be accomplished using personnel assigned to the Commander for this purpose. Any additional personnel needs will require the approval of the Sheriff or Assistant Sheriff. Notification of use of personnel from other components will be made with as much advanced notice to the affected division commander as possible.

The Commander, Homeland Security and Intelligence Section will cause the Agency Emergency Management Manual to be reviewed at least annually and updated as may be required by changing circumstances. The Commander will likewise cause changes in the Manual as a result of after action critique results.

[REDACTED]

[REDACTED]

[REDACTED]

[REDACTED]

[REDACTED]

- [REDACTED]
- [REDACTED]
- [REDACTED]
- [REDACTED]
- [REDACTED]
- [REDACTED]
- [REDACTED]
- [REDACTED]
- [REDACTED]
- [REDACTED]
- [REDACTED]

[REDACTED]

[REDACTED]

[REDACTED]

- [REDACTED]
- [REDACTED]



Administrative and Operational Manual

September 12, 2022



**2-408.3 FIREARMS INVESTIGATION UNIT (FIU)**

The Firearms Investigation Unit (FIU) will conduct initial and follow-up investigations into firearms-related criminal offenses. This may include cases involving:

- Illegal manufacture, sale, or distribution of firearms or firearm equipment or paraphernalia;
- Large-scale firearm thefts, or thefts from Federal Firearms Licensees (FFL);
- Possession of firearms by prohibited persons;
- Assaults or reckless endangerment cases involving firearms; and
- Follow up investigation of NIBIN leads;
- Other investigations as assigned.

Detectives assigned to this Unit will provide assistance to other Agency members in handling cases requiring the expertise of the Unit's investigators.

**2-408.4 CRIME ANALYSIS FUNCTION**

The Crime Analysis Function is responsible for the collection and presentation of data regarding criminal activity in a manner which allows operational components of the Agency to more intelligently deploy resources to prevent crime and apprehend criminals. Additionally, this Function gathers data regarding operational workload distribution of the various components and organizes that data in a manner which allows its use to make staffing decisions.

This Function gathers data from the Agency Computer-Aided Dispatch System and the Agency Records Management System in order to develop crime analysis reports. The data should be analyzed and any sources verified, so that obviously erroneous information is excluded from the reports. This data is then organized in a manner which presents the occurrence of crimes according to geographical location, time of day, day of week, and any notable annual or seasonal groupings. The reports generated as a result of this process are distributed to the Criminal Investigations Division and Patrol Operations with accompanying maps as needed to explain complex patterns. A regular feedback analysis of users of the data is completed each six months in order to make presentations and data analysis more valuable to these users. A quarterly briefing is prepared by this Function for presentation to the Sheriff by the Commander, Criminal Investigations Division.

The regular crime analysis reports previously described will be distributed weekly, unless unusual events suggest a need for interim reports. The geographical data will at least segregate data to the beat level. In cases where circumstances warrant, the data may be for a neighborhood or for a specific location. The data concerning time of day will at least be as specific as to specify one of the three different patrol shifts of days, nights, and midnights and particular days of the week. When available, victim descriptors, suspect descriptors, and vehicle descriptors will be supplied for identified suspects. When available, modus operandi and physical evidence likely to be found in connection with a particular suspect or series of crimes will be explained. Any identified strategies for combating particular criminal activities will be included in these reports. These reports are confidential documents, internal to this Agency, and the report or the information contained therein will not be distributed beyond Agency personnel without the approval of the Sheriff.



## Administrative and Operational Manual

September 12, 2022

## **2-409 THREATS OF MASS VIOLENCE OR THREATS TO HARM OFFICIALS (OTHER THAN LAW ENFORCEMENT OFFICERS) OR ATTACK GOVERNMENT FACILITIES**

Recent history has shown in many cases individuals voice frustration against potential targets leading up to or during the planning phases of an attack. Threats come to light in many forms but most commonly are discovered through friends / family members, conversation (direct or overheard) or written (letter, email, or social media). No matter how a threat comes to light, it is imperative law enforcement investigate any threat of mass violence, or violence targeted at government institutions / officials. Employees who become aware of any type of threat falling under this policy shall, at minimum, cause a report to be written immediately. All pertinent facts of the threat shall be reported to the Commander, Homeland Security and Intelligence Section as expeditiously as possible. The Homeland Security and Intelligence Section will conduct a threat assessment using all known information and will assist in determining the next steps in the investigative process.

## **2-410 OFFICER SAFETY ALERTS**

Employees receiving information from sources outside the Agency, relating to officer safety or threats against law enforcement and/or government, shall forward the information to the Homeland Security and Intelligence Section of the Criminal Investigations Division for verification and dissemination. In cases where the information is critical to law enforcement operations or includes a serious officer safety threat, the employee shall immediately contact the Homeland Security and Intelligence Section. An officer assigned to the Section will review and investigate the information for possible dissemination.

In instances where an officer from the Homeland Security and Intelligence Section cannot be reached, and the threat or concern is of a critical nature, the information will be sent to the SMIC for vetting and distribution.

Employees are prohibited from the routine dissemination (electronic, written, etc.) of officer safety issues, threats against law enforcement and/or the government, or trends in law enforcement.

### **2-410.1 DISSEMINATION**

Routine officer safety bulletins will be produced by the Homeland Security and Intelligence Section when needed concerning issues in law enforcement trends, gang activities, Homeland Security issues or concerns with officer safety. Immediate dissemination of critical officer safety issues will be distributed electronically on the Agency email system and in some cases broadcast on the Agency radio system.

## **2-411 DISSEMINATION OF PHOTOGRAPHS AND CREATION OF CRIME BULLETINS**

Employees who need to disseminate photographs of wanted suspects, photographs of suspects who need to be identified, or other surveillance type photos, should forward all information to the Homeland Security and Intelligence Section via email at [intel@ccso.us](mailto:intel@ccso.us). If the product requested is of a critical nature and requires immediate attention and HSI is unavailable, officers should contact the Southern Maryland Information Center (SMIC) for dissemination. SMIC will ensure swift dissemination and ensure that large files are reduced to be compatible with the email system. This will be done in such a manner that the image's value to the investigation is preserved. Where requested, HSI or SMIC will analyze the information in accordance with the needs of the investigation. Due to the file size of most photographs and surveillance images, and the limited distribution of the intra-Agency email system, employees should refrain from personally distributing photos via the Agency email system.

## **2-412 FORENSIC SCIENCE SECTION**

The Forensic Science Section is primarily a support section for the investigators of CID. The Section is staffed by



**Administrative and Operational Manual**

**September 12, 2022**

the Deputy Director FSS, Quality Assurance Manager, Forensic Science Technicians, Latent Print Specialists, and a Forensic Chemist. The Section is responsible for:

- processing the scenes of major criminal events to locate, identify, collect, preserve, and examine physical evidence;
- lifting latent fingerprints;
- evaluating and comparing latent fingerprints;
- taking specialized photographs;
- examining, enhancing, copying, and formatting evidence captured on video;
- developing and preparing specialized drawings and diagrams necessary for the prosecution of a particular case;
- coordinating the Test Shot Program and the acquisition of ballistic evidence into the National Integrated Ballistic Information Network (NIBIN);
- analyzing Controlled Dangerous Substances (CDS) at the Maryland State Police Forensic Sciences Division in Pikesville;
- providing expert testimony in court;
- providing support to the other components of the Agency in their area of expertise as directed by the Investigations Section Commander; and
- such other duties as may be assigned.

## **2-450 CORRECTIONS DIVISION**

The Corrections Division is responsible for the incarceration of locally sentenced inmates, for a period of up to 18 months, as well as detention of prisoners who are awaiting trial. The division is comprised of three facilities: the Detention Center, the Annex (which houses work-release inmates, women, and weekenders), and Court Holding. The Center also holds “safekeepers” from the State and other local jurisdictions.

### **2-450.1 ORGANIZATION**

The Corrections Division is managed by the Commander / Director of the Charles County Detention Center. The Commander / Director is directly supported by the Deputy Director and a staff consisting of a Standards and Accreditation Commander; Support Services Commander; Custody and Security Commander; Commander, Custody and Security / Annex; and an Administrative Supervisor.

### **2-451 COMMANDER / DIRECTOR, CORRECTIONS DIVISION**

The Commander / Director, Corrections Division is a correctional officer with analogous credentials and leadership abilities. The Commander / Director shall be responsible directly to the Assistant Sheriff of Administration for all matters pertaining to the responsibilities and elements of the command. The Commander / Director is responsible for the supervision of subordinates and the performance of administrative duties pertaining to the daily operation of the division. The Commander / Director is responsible for the performance of all personnel assigned to this command.

The Commander / Director shall inspect the personnel, equipment, facilities, and other resources assigned to this command on a regular basis. The Commander / Director shall be responsible to maintain these elements of command in compliance with the policies set forth in this Manual and in other official directives of the Agency. The Commander / Director shall maintain and operate the Detention Center so that it is in compliance with all applicable state and federal requirements for such facilities.

In addition to, or as enumerated by, the position description for this position, the Commander / Director will have the following duties and responsibilities:

- ensure that CCDC is kept in a clean and orderly state and that it is at all times ready for the task of housing and securing the various inmates assigned to its keeping;



**Administrative and Operational Manual**

**September 12, 2022**

- ensure adequate staffing at all times and in all places within the Corrections Division, within the framework of the personnel assigned to this command, to maintain security and order and to respond to emergencies;
- check personnel and equipment for their state of readiness to perform their designated duties;
- evaluate the methods of operation of this command and make recommendations for their improvement;
- administer all responsibilities assigned, within the framework of that portion of the Agency budget committed to the current fiscal year; and
- plan for future events and conditions and provide a budget request each year outlining the requirements of the division for the coming fiscal year.

**2-451.1 INTERNAL INVESTIGATOR**

The Internal Investigator function is staffed by a Correctional Lieutenant, who reports directly to the CCSO Office of Professional Responsibility (OPR) Commander. This function is responsible for the following:

- Administer the investigation and resolution of all cases of alleged misconduct by Agency Corrections personnel;
- Maintain records of complaints against Corrections employees;
- Maintain data regarding discipline actions;
- Provide support for administrative hearings; and
- Other duties as directed by the OPR Commander.

**2-452 DEPUTY DIRECTOR**

The Deputy Director shall be responsible directly to the Commander / Director, Corrections Division. The Deputy Director is responsible for the direct supervision of the commanders of the Custody and Security, Custody and Security / Annex, and Support Services Sections. Additionally, the Deputy Director will supervise the Administrative Supervisor. The Deputy Director will assist the Commander / Director in fulfilling the requirements set forth in Section 2-451 of this chapter and will act on behalf of the Commander / Director, in the Commander's / Director's absence.

The Deputy Director will aid in establishing operational procedures, including rules and regulations, security procedures, and supervision techniques.

**2-453 STANDARDS AND ACCREDITATION COMMANDER**

The Standards and Accreditation Commander is a Corrections Lieutenant who shall be directly responsible to the Commander, Support Services. The Standards and Accreditation Commander shall continually audit the facilities, processes, procedures, and performance of personnel to determine that standards established by the Maryland Commission of Correctional Standards are met or exceeded. The Standards and Accreditation Commander will immediately advise the Commander, Support Services of any deficiencies identified and make recommendations for their correction. Specifically, the Standards and Accreditation Commander shall:

- write specific policy to ensure that standards are met or exceeded;
- maintain, refine, update, and improve the Standard Operating Procedures (SOP) Manual and Policy and Procedure Manual of the Corrections Division;



**Administrative and Operational Manual**

**September 12, 2022**

- 
- ensure the compatibility of the materials contained in the Corrections Policy and Procedure Manual with that contained in the Agency AOM;
  - coordinate efforts with Planning & Accreditation of the Agency in order to prevent duplication of effort and ensure Agency continuity of policy;
  - maintain division inspection and control of assigned SOP and AOM documents to ensure accuracy of content and the accountability for receipt of these materials;
  - assist with training in regard to SOP and AOM materials to new and in-service personnel; and
  - at least annually conduct a comprehensive review of Corrections Division and Agency policy and ensure revisions, additions, or deletions as may be found necessary by such review;
  - conduct audits of all areas of the facilities, to include contractors;
  - ensure compliance with all applicable standards of the Maryland Commission on Correctional Standards which fall under the tasks and circumstances of his command.

**2-454 ADMINISTRATIVE SUPERVISOR**

The Administrative Supervisor is directly responsible to, and supervised by, the Deputy Director. The Administrative Supervisor supervises the clerical staff of the division. The duties of this position include:

- composing and typing correspondence, forms, and reports;
- managing administrative records;
- managing payroll and time and attendance reports;
- maintaining statistical information and preparing statistical reports;
- assisting with budget management and preparation; and
- other associated duties.

Civilian clerical staff assigned as receptionists and part-time front desk support will be responsible to the Administrative Supervisor. They will receive visitors to the facility; perform routine clerical functions, and other duties as assigned.

**2-460 CUSTODY AND SECURITY SECTION**

The Custody and Security Section is commanded by a Corrections Captain who is directly responsible to the Deputy Director. The Commander, Custody and Security Section is responsible for the overall security of the CCDC facility and for the security of all inmates confined therein. He is responsible for the supervision of all personnel assigned to his command. In addition to, or as enumerated by, the position description for his position, the commander will have the following duties and responsibilities:

- ensure the facility is impervious to outside forces which may be foreseen to attempt to infiltrate or penetrate the security of the facility;
- ensure that the facility is safe from internal schemes or attempts to escape or move contraband into or from the facility;
- formulate plans, develop and revise policies and procedures in order to assure the safety and security of the facility;
- ensure that the duties and responsibilities of all personnel under his supervision are clear and appropriate to the particular task assigned and are communicated to the individual employee in a manner necessary to





**Administrative and Operational Manual**

**September 12, 2022**

avoid confusion;

- provide for the necessary training of personnel to ensure they are prepared for their assigned tasks;
- ensure compliance with all applicable standards of the Maryland Commission on Correctional Standards which fall under the tasks and circumstances of his command;
- ensure the preparation and response of the Emergency Response Team to events requiring their services; and
- inspect the facility on a weekly basis for cleanliness, safety, and security;
- establish operational procedures, including rules and regulations, security procedures, and supervision techniques.

**2-461 ASSISTANT COMMANDER, CUSTODY AND SECURITY**

The Assistant Commander, Custody and Security, is a Lieutenant responsible to the Commander, Custody and Security. This position is responsible for ensuring all officers are current with mandatory training and capitalizes on training opportunities for officers as well as civilian staff. The Assistant Commander will assist the Commander, Custody and Security in fulfilling the requirements set forth in Section 2-460 of this chapter and will act on behalf of the Commander, Custody and Security in the Commander's absence. The Assistant Commander will provide training with regard to SOPs, policy and procedure, and the AOM materials to new and in-service personnel. He will also create annual staff awareness training and testing and maintain training records for MPTSC accreditation.

**2-462 SHIFT COMMANDER**

Each shift commander, a Lieutenant, shall be responsible to the Commander, Custody and Security for the performance of the shift in fulfilling the requirements of the Custody and Security Section during the shift's tour of duty. The Annex Lieutenant is responsible to the Commander of the Annex and fulfills the requirements set forth by the Commander of the Annex in his absence.

**2-463 SHIFT SUPERVISOR**

Each shift supervisor, a Sergeant, is responsible to his shift commander for the performance of officers assigned to his shift. The shift supervisor may also act as the shift commander at the direction of, and in the absence of, the shift commander.

**2-463.1 ASSISTANT SHIFT SUPERVISOR**

Each assistant shift supervisor, a Corporal, shall assist the shift supervisor in carrying out the shift supervisor's responsibilities and act as shift supervisor in the shift supervisor's absence.

**2-470 SUPPORT SERVICES SECTION**

The Support Services Section of the division is commanded by a Corrections Captain who is responsible to the Deputy Director. The Support Services Section is comprised of the Central Processing Unit and the Inmate Programs and Services Unit. In addition to oversight of these two units, the Support Services Section is responsible for:



**Administrative and Operational Manual**

**September 12, 2022**

- 
- ensuring that the facility is safe from internal schemes or attempts to escape or move contraband into or from the facility;
  - formulating plans, developing and revising policies and procedures in order to assure the safety and security of the facility;
  - ensuring that the duties and responsibilities of all personnel under his supervision are clear and appropriate to the particular task assigned and are communicated to the individual employee in a manner necessary to avoid confusion;
  - providing for the necessary training of personnel to ensure they are prepared for their assigned tasks;
  - ensure compliance with all applicable standards of the Maryland Commission on Correctional Standards which fall under the tasks and circumstances of his command;
  - inmate property control;
  - purchasing of supplies;
  - inventory maintenance and control;
  - hazardous materials control; and
  - management of the Detention Center library.

**2-471 CENTRAL PROCESSING UNIT**

The Central Processing Unit is commanded by a Corrections Lieutenant who is directly responsible to the Commander, Support Services Section. The Commander, Central Processing will supervise and direct Prisoner Transport, Court Holding, Intake & Discharge, Central Processing, and Security Maintenance. In addition to, or as enumerated by, the position description for his position, the Commander will have the following duties and responsibilities:

- oversee and control the daily operation of the components and personnel assigned to his command;
- audit and inspect the operation of the components of his command to determine the efficiency and effectiveness of that operation;
- implement changes as needed to correct for discovered discrepancies in the operation of the components of his command;
- when the resources under his control are found to be inadequate for the responsibilities assigned or it is anticipated that they will become so in the future, notify the Commander, Support Services with estimates of the scope of needed resources;
- ensure the completeness, accuracy, and security of records regarding individuals detained at the CCDC;
- maintain liaison with the court systems and other corrections and police agencies with which the CCDC is required to interact;
- control the transport process to ensure that it is timely and that schedules are met.

**2-472 INTAKE**



**Administrative and Operational Manual**

**September 12, 2022**

---

The Intake Function is supervised by a Corrections Sergeant responsible to the Commander, Central Processing. In addition to intake, this component is responsible for inmate property control.

**2-473 TRANSPORT**

The Transport Function is supervised by a Corrections Sergeant responsible to the Commander, Central Processing. This component is responsible for transports and the court holding facility.

**2-474 CENTRAL PROCESSING**

The Central Processing function of the Central Processing Unit is overseen by a civilian Central Processing Supervisor responsible to the Commander, Central Processing Unit. This component is comprised of civilian support staff, and is tasked with all duties associated with inmate processing.

**2-475 INMATE PROGRAMS AND SERVICES UNIT**

The Inmate Programs and Services Unit is commanded by a Corrections Lieutenant who is directly responsible to the Commander, Support Services. The Commander, Inmate Services Unit is responsible for the services provided to or for inmates which are outside the basic functions of housing and security. Some examples are work release, classification and treatment, commissary services, gang unit, and security maintenance. The Commander is responsible for the supervision of all personnel assigned to his command. In addition to, or as enumerated by, the position description for his position, the Commander will have the following duties and responsibilities:

- formulate plans, develop and revise policies and procedures in order to assure the proper operation of the functions within his command;
- ensure that the duties and responsibilities of all personnel under his supervision are clear and appropriate to the particular task assigned and are communicated to the individual employee in a manner necessary to avoid confusion;
- provide for the necessary training of personnel to ensure they are prepared for their assigned tasks; and
- ensure compliance with all applicable standards of the Maryland Commission on Correctional Standards which fall under the tasks and circumstances of his command.

**2-476 CLASSIFICATION**

The classification function is supervised by a Corrections Case Management Supervisor responsible to the Commander, Inmate Services. This component is tasked with all duties related to inmate classification and administrative hearings.

**2-476.1 INTELLIGENCE OFFICER**

The Intelligence Officer is responsible to the Correctional Case Management Supervisor. This officer is tasked with gathering intelligence and information from suspected and known gang members for the purpose of information sharing with appropriate entities.

**2-476.2 SECURITY MAINTENANCE SERGEANT**

The Security Maintenance Sergeant is supervised by the Commander of Inmate Services. This component is



**Administrative and Operational Manual**

**September 12, 2022**

responsible for all non-County maintenance within the Detention Center, Annex, and Court Holding, to include scheduling and meeting with maintenance vendors, proper operation of doors, cameras, and all locking devices. This Sergeant works hand in hand with County Maintenance and outside vendors in the repairs of all equipment inside the detention center complex.

**2-480 CCDC ANNEX**

The CCDC Annex is commanded by a Corrections Captain who is directly responsible to the Deputy Director. The Section is responsible for the overall security of the CCDC Annex and for the security of all inmates confined therein, to include work release, women, weekenders, inmates with less than 60 days, and Accounting. He is responsible for the supervision of all personnel assigned to his command. In addition to, and as enumerated by, the position description for this position, the Commander will have the following duties and responsibilities:

- ensure the facility is impervious to outside forces which may be foreseen to attempt to infiltrate or penetrate the security of the facility;
- ensure the facility is safe from internal schemes or attempts to escape or move contraband into or from the facility;
- formulate plans, develop and revise policies and procedures in order to assure the safety and security of the facility;
- ensure the duties and responsibilities of all personnel under his supervision are clear and appropriate to the particular task assigned and are communicated to the individual employee in a manner necessary to avoid confusion;
- ensure compliance with all applicable standards of the Maryland Commission on Correctional Standards which fall under the tasks and circumstances of his command;
- inspect the facility on a weekly basis for cleanliness, safety, and security;
- formulate plans, develop and revise policies and procedures in order to assure the safety and security of the facility.

**2-481 ASSISTANT COMMANDER, ANNEX**

The Assistant Commander of the Annex is a Lieutenant who is directly responsible to the Commander of the Annex. The Assistant Commander will assist the Commander of the Annex in fulfilling the requirements set forth in Section 2-480 of this chapter and will act on behalf of the Commander of the Annex in the Commander's absence.

**2-482 WORK RELEASE**

The Work Release Coordinator is a civilian who is directly responsible to the Annex Lieutenant. The position involves the planning, assigning, supervising, and appraising the work of subordinate officers. The Coordinator is tasked with all duties related to inmates assigned to the work release program. Responsibilities include:

- Working closely with District and Circuit courts;
- Establishing operational procedures, including rules and regulations, security procedures, and supervision techniques;



**Administrative and Operational Manual**

**September 12, 2022**

- Evaluating methods of work release operation and making recommendations for improvement;
- formulating plans, developing and revising policies and procedures in order to assure the safety and security of the facility.

### **2-482.1 WORK RELEASE ASSISTANT**

The Work Release Assistant is a corrections officer, responsible to the Work Release Coordinator. This position is responsible for all collection, testing, and documentation of urinalysis specimens. The Assistant assists with interviewing and processing inmates into the work release program.

### **2-482.2 WORK RELEASE INVESTIGATOR**

This position is staffed by a correctional officer responsible to the Work Release Coordinator. The function of this position is to process eligible inmates into the Work Release Program, to include the following:

- Conduct on-site visits to employers;
- Verify inmates' attendance at work sites;
- Assist the Work Release Assistant to ensure compliance with standards established by the Maryland Commission on Correctional Standards.

### **2-482.3 INMATE ACCOUNTING SPECIALIST**

The Accounting function of the division is staffed by a civilian responsible to the Work Release Coordinator, who is responsible to the Lieutenant of the Annex. This component is tasked with all matters relative to internal inmate financial accounts, inmate visiting, and federal, state, and juvenile accounts and billing.

## **2-500 SPECIAL SERVICES DIVISION**

The Special Services Division is that component of the Agency which has the primary responsibility for the activities of the Sheriff which are related to the courts and the judicial process. Additionally, this division handles the supply functions and the maintenance of property which has been found, seized, or recovered. Among the various specific functions of this division are found:

- enforcement of child support orders of the courts;
- enforcement of orders of the court with regards to domestic violence;
- the protection of judicial officers and various courtrooms;
- the service of civil papers;
- the detection and arrest of fugitives;
- the acquisition, storage, and distribution of uniforms and equipment used by Agency personnel;
- the storage and disposal of the property held by the Agency because it was found, recovered after being stolen, is evidence, or was confiscated as contraband;
- Agency risk management; and
- Agency owned, leased, or loaned facilities (except detention facilities).

### **2-500.1 ORGANIZATION OF SPECIAL SERVICES DIVISION**

The Special Services Division is comprised of two sections: Judicial Services Section and Property Management Section. The Judicial Services Section contains the Volunteers In Community Service (VICS), Child Support Enforcement Unit, the Warrant / Fugitive Unit, the Domestic Violence Unit, the Civil Unit, and the Courts / Judicial Security Unit. The Property Management Section contains the Quartermaster Section, the Property Custodian, the Procurement Specialist, Firearms Tracking Specialist, and Fleet.



Administrative and Operational Manual

September 12, 2022

## 2-501 SPECIAL SERVICES DIVISION COMMANDER

The Special Services Division Commander is a sworn officer who shall be responsible directly to the Assistant Sheriff of Administration. He is responsible for the direct supervision of subordinates and the performance of administrative duties pertaining to the daily operation of the Division. He is responsible for the performance of all personnel assigned to his command.

The Special Services Division Commander shall be responsible for maintaining the relationships between the CCSSO and the various judicial officials with whom the Agency deals. The Commander shall inspect the various courtrooms for which he is responsible and provide for their security, making recommendations to the Sheriff and the various judicial officials as may be appropriate. He will develop measures for the overall security of the Charles County Courthouse.

The Special Services Division Commander is responsible for the availability and maintenance of all supplies and equipment used by Agency personnel in the performance of their duties. This includes the Agency fleet of vehicles, their fuel, equipment, insurance, maintenance, and repair. The Commander is responsible for overall fleet safety and shall monitor collision and damage reports as well as injury reports, where the cause of injury is a fleet collision. The Commander shall maintain such statistical information in this regard that he may make recommendations to the Commander, Training Division, the Assistant Sheriffs and the Sheriff's "Safe Driving Programs," driver training, Collision Free Driving awards, and budget information.

The Special Services Division Commander is responsible for the secure and efficient storage and disposition of all property which may come into the keeping of the Agency as a result of its daily law enforcement and public safety activities. This would include evidence, contraband, recovered stolen property, found property, etc. The Commander shall develop and implement such policies as will allow for the proper chain of custody of evidence and for the availability of the evidence for presentation in court. He will provide for the disposition of all property which has been held past its usefulness as evidence or which has gone unclaimed for a period required by law. He will see that such funds as may be derived from the sale of property and any cash held, which may be legally converted to the use of the Sheriff's Office or government activities, is deposited in the proper government accounts.

The Special Services Division Commander shall require members of his command to support the efforts of the courts to:

- curb domestic violence;
- transport fugitives outside the State of Maryland as well as capture fugitives in Charles County wanted by other states and coordinate extradition between the State's Attorney's Office and other agencies.
- facilitate such civil matters as may come under the jurisdiction of the Office of the Sheriff.

The Special Services Division Commander shall inspect the personnel, equipment, facilities, and other resources assigned to his command on a regular basis. He shall be responsible to maintain these elements of his command in compliance with the policies set forth in this Manual and in other official directives of the Agency.

## 2-502 JUDICIAL SERVICES SECTION

The Judicial Services Section is responsible to:

- maintain a safe court environment;
- provide support of the court in the arrest of persons for whom the court has issued warrants;
- serve such civil processes as may be issued by the court; and
- provide support of the court in areas pertaining to domestic violence.



Administrative and Operational Manual

September 12, 2022

## 2-502.1 ORGANIZATION

Judicial Services Section is comprised of the following six units:

- Volunteers In Community Service (VICS);
- Domestic Violence;
- Warrant / Fugitive;
- Civil;
- Courts / Judicial Security; and
- Child Support Enforcement.

## 2-510 COMMANDER, JUDICIAL SERVICES SECTION

The Commander, Judicial Services Section reports to, and is responsible to, the Commander, Special Services Division. The Commander, Judicial Services Section will ensure that the responsibilities of the Judicial Services Section are faithfully carried out and that personnel within his command:

- are knowledgeable in their respective areas of responsibility;
- are aware of all rules, laws, and procedures which affect the performance of their duties;
- are properly equipped and prepared for the tasks which they are required to complete;
- attend to their duties and responsibilities in a timely and expeditious manner;
- execute their daily activities consistent with the essential functions established for their specific position and within the framework of the Manual of this Agency and any Standard Operating Procedures established for the Judicial Services Section; and
- faithfully discharge their lawfully assigned tasks and duties.

## 2-515 DOMESTIC VIOLENCE UNIT

Personnel assigned to Domestic Violence receive and serve interim / temporary / final / modified protective orders, interim / temporary / final / modified peace orders, arrest warrants, criminal summonses, and other civil and criminal process. Sworn officers assigned to this Unit will respond to domestic violence calls for service, take initial reports, apply for warrants when appropriate, and make on-scene arrests when appropriate. These officers will give guidance to victims and coordinate efforts with community groups and services for domestic violence.

### 2-515.1 SUPERVISOR'S RESPONSIBILITIES

The Domestic Violence Unit Supervisor is a sworn officer who is responsible for the daily operation of the Unit. The Supervisor will maintain a close working relationship with the courts, concerned agencies, and domestic violence volunteer groups. The Supervisor will maintain monthly and yearly statistics for reporting purposes. The Unit Supervisor will assist the Judicial Services Section Commander, learning that position in order that he may fill that role as required in the Commander's absence.

### 2-515.2 DUTIES OF OFFICERS ASSIGNED TO DOMESTIC VIOLENCE

Officers assigned to this function shall receive and serve domestic violence processes, including ex-parte orders, protective orders, peace orders, modification orders, and show cause orders. They will serve criminal processes related to domestic violence cases. They will maintain close working relationships with various citizens' groups concerned with the area of domestic violence prevention and intervention. They will also respond to associated calls and make on-scene arrests as may be indicated. These officers shall maintain a working relationship with the judges, magistrates, and court personnel who are associated with the domestic violence area of the law.

**Administrative and Operational Manual****September 12, 2022****2-515.3 DOMESTIC VIOLENCE SPECIALIST**

The Domestic Violence Specialist is a civilian who is responsible to the Domestic Violence Unit Supervisor. The Specialist will be responsible for data entry of civil and criminal warrants / processes. The Specialist will enter, modify, clear, cancel, etc., civil and criminal warrants / processes and all peace orders in the Agency computer system, METERS, and NCIC as necessary. The Specialist is responsible for entry of all ex-parte and protective orders into the METERS system. The Specialist will prepare papers for entry by conducting inquiries of subjects (i.e., local computer, MVA computer, Maryland raps, etc.). The Specialist will send and receive teletypes to and from allied agencies. The Specialist will maintain a close working relationship with the courts, concerned agencies, and domestic violence volunteer groups. The Specialist will assist the Unit Supervisor with monthly and yearly statistics for reporting purposes. The Domestic Violence Specialist will be responsible for other duties as assigned.

**2-520 WARRANT / FUGITIVE UNIT**

This Unit acts as the Agency fugitive squad and handles the extradition of persons captured out of state for crimes committed within Charles County and arranges for their return to stand trial. Sworn officers are responsible for prisoner transports including long-distance extraditions and duties as may be assigned. Personnel assigned to the Warrant / Fugitive Unit receive and serve arrest warrants, attachments, criminal summonses, summons / indictments, and criminal information. Officers will assist the Unit Supervisor and will be responsible for other duties as assigned.

**2-520.1 SUPERVISOR'S RESPONSIBILITIES**

The Warrant / Fugitive Unit Supervisor is a sworn officer responsible for the daily operation of the Unit. The Supervisor will maintain a close working relationship with the courts and other concerned agencies, including U.S. Marshals. The Supervisor will maintain monthly and yearly statistics for reporting purposes. The Unit Supervisor will assist the Judicial Services Section Commander, learning that position in order that he may fill that role as required in the Commander's absence.

**2-520.2 DUTIES OF OFFICERS ASSIGNED TO WARRANT SERVICE**

Sworn officers assigned to warrant service are responsible for the service of arrest warrants, attachments, criminal summonses, summons / indictments, and criminal information. Sworn officers are responsible for prisoner transports including long-distance extraditions and duties as may be assigned by supervisory personnel. Officers will assist the Unit Supervisor and will be responsible for other duties as assigned.

**2-520.3 WARRANT / FUGITIVE SPECIALIST**

The Warrant / Fugitive Specialist is a civilian who is responsible to the Warrant / Fugitive Unit Supervisor. The Specialist will be responsible for data entry of civil and criminal warrants / processes. The Specialist will enter, modify, clear, cancel, etc., civil and criminal warrants / processes in the Agency computer system, METERS and NCIC. The Specialist will prepare papers for entry by conducting inquiries of subjects (i.e., local computer, MVA computer, Maryland raps, etc.). The Specialist will send and receive teletypes to and from allied agencies. The Specialist will assist the Unit Supervisor with monthly and yearly statistics for reporting purposes. The Warrant / Fugitive Specialist will be responsible for other duties as assigned.

**2-530 CIVIL UNIT**

This Unit provides for the service of civil processes, including, but not limited to, subpoenas, summonses, evictions, and juvenile court papers. It is also responsible for the seizure, and in some cases, the seizure and sale, of personal and/or real properties as required by court order.

The Unit is responsible for the service of warrants of restitution without partiality to either the landlord or tenant. It





**Administrative and Operational Manual**

**September 12, 2022**

conducts sales and attaches property. Its personnel may at any time be required to assist wherever needed within the organization.

The Unit is staffed with both sworn officers and civilian Civil Process Server Specialists. Sworn officers are required to perform all of the duties of this section. Civilian Civil Process Server Specialists are required to perform only the duties which do not require the power of arrest or the use of force.

### **2-530.1 CIVIL UNIT SUPERVISOR**

The Supervisor of this Unit will oversee Sheriff's sales, evictions, writs of execution, and all other civil process. The Supervisor will maintain monthly and yearly statistics for reporting purposes. The Civil Unit Supervisor will maintain a close working relationship with the courts and other law enforcement agencies. The Unit Supervisor will assist the Judicial Services Section Commander, learning that position in order that he may fill that role as required in the Commander's absence.

### **2-530.2 CIVILIAN CIVIL PROCESS SERVER SPECIALISTS**

Employees who occupy the position of Civil Process Server Specialist are not sworn law enforcement officers. They have no power of arrest, and are not expected to, or empowered to, use any level of force in the performance of their duties. These employees are, however, agents of the Sheriff of Charles County, Maryland, for the purpose of providing the service of civil process on behalf of the Sheriff.

Employees in this position are not issued impact weapons, firearms or any other type of weapon with the exception of a K-9, taser and spray, which may be issued to ward off attacking animals. The Sheriff does not expect or anticipate that weapons will be needed or used by the individuals who perform the duties of civilian Civil Process Server Specialist; however, weapons may be carried under the provisions of HR-218.

This position requires civilian Civil Process Server Specialists to deliver original court documents to individuals who are named in those documents. Delivery will be accomplished without the use of force, and the civilian Civil Process Server Specialist will retreat from any threatening or hostile situation which develops during the attempted service of these papers.

Civilian Civil Process Server Specialists will not participate in the service of any document which requires arrest powers. They may serve papers which notify a witness / defendant / petitioner / respondent of the date, time, and place of an appearance or required action in a criminal or civil trial / hearing / matter. Civilian Civil Process Server Specialists may assist sworn officers in the handling of certain scenes, such as an eviction scene, only after sworn officers have made that scene secure and removed any persons who may pose a threat.

Civil Process Server Specialists have the rights and privileges granted to ordinary citizens, and as such are not prohibited to take such action as could an ordinary citizen. This would include the right to defend themselves from attack to the degree that any citizen would be able to defend themselves or others.

### **2-530.3 DUTIES OF CIVILIAN CIVIL PROCESS SERVER SPECIALISTS**

Civil Process Server Specialists will locate the addresses of individuals to be served civil process by the use of the Motor Vehicle Administration computers, telephone directories, road maps, and such other information sources as may be legally available. They will examine those civil documents which come into their possession to ensure correctness and completeness before attempting to serve them. They will communicate with the supervisor of the Civil Unit concerning any discrepancies in these documents and take the action necessary to have the discrepancies corrected.

Civil Process Server Specialists will be familiar with the rules and procedures established in law and by court rulings concerning the service of civil processes. They will follow and abide by these rules of procedure in the course of



**Administrative and Operational Manual**

**September 12, 2022**

their work, as well as any non-conflicting SOP's. They will make accurate and timely returns to the court of the action taken on each document.

The Civil Process Server Specialist operates vehicles of the Sheriff's Office in the course of his duties. Such operation will be in accordance with the rules and policies of the Agency and within the laws of the State of Maryland.

The Civil Process Server Specialist may assist in the service of writs of execution, writs of possession, writs of replevin, warrants of restitution, and the sale of various real and personal properties. Civil Process Server Specialists will perform such other duties as are appropriate to this class of work, to include service of civil process outside of Charles County as may be assigned from time to time by supervisory personnel. Civilian Civil Process Server Specialists will not execute evictions, writs of possession, landlord / tenant warrants of restitution, writs of execution, sheriff's sales, criminal process, or any other process that requires service by a sworn officer.

Civil process shall not be served on any inmate who is in the temporary custody of the Sheriff of Charles County, being housed under the Interstate Agreement on Detainers (IAD).

### **2-530.4 DUTIES OF OFFICERS ASSIGNED TO SERVE CIVIL PROCESS**

Sworn officers of the Civil Unit who are assigned to civil process duties are responsible for service of civil and criminal process, including but not limited to: subpoenas, summonses, seizure and sale of all personal or real properties as required by the court, writs of execution, writs of possession, landlord / tenant warrants of restitution, Sheriff's sales, and all other process which cannot be served by the civilian process server.

Sworn officers are required to assist courthouse security as may be assigned. Sworn officers will assist the Unit Supervisor as needed and will be responsible for other duties as assigned.

### **2-530.5 CIVIL SPECIALISTS**

Civilian civil specialists are responsible for data entry of all civil process received by this Agency. Specialists will enter, modify, clear, cancel, etc., civil and criminal process in the Agency computer system. Specialists will prepare papers for entry by conducting inquiries of subjects named (i.e., local computer). Specialists will keep in close contact with the courts. Specialists will send and receive facsimiles to and from other agencies. Specialists will assist the Unit Supervisor as needed and will be responsible for other duties as assigned.

### **2-535 COURTS / JUDICIAL SECURITY UNIT**

This Unit shall be responsible for the physical security of the courthouse and for maintenance of courtroom security. Judicial Security is comprised of full-time sworn officers, sworn full-time reduced hours officers, sworn part-time officers, correctional officers, and part-time security aides. Employees will operate metal detectors to screen visitors to the courthouse in an effort to maintain a safe environment for employees and the general public. Employees will work shifts so as to open and close the courthouse and assure that the building is secure upon closing. Officers working courtroom security will assist the sitting judge and will carry out instructions from the judge in a courteous and expeditious manner. Officers will transport prisoners between court holding and the courtrooms as needed and maintain order within their courtrooms. Employees will assist the Unit Supervisor as needed and will be responsible for other duties as assigned.

#### **2-535.1 COURTS / JUDICIAL SECURITY UNIT SUPERVISORS**

The Courts / Judicial Security Supervisor is a sworn officer who is responsible for the daily operation of the Unit. The Supervisor will:

- ensure there is available adequate personnel each day to provide the necessary security for the Courthouse and any courtrooms in use; and



**Administrative and Operational Manual**

**September 12, 2022**

- coordinate courtroom security assignments and courthouse security assignments as well as prisoner transports between court holding and the courtrooms; and
- be responsible for the issuance and security of any and all passes used to control admittance to the Courthouse; and
- maintain accurate records concerning these passes and any door keys controlling access at the Courthouse; and
- assist Public Facilities in overseeing the maintenance of the alarm system installed at the Courthouse; and
- attempt to identify the cause of any false alarm generated by the system; and
- work within the supervisory structure of the CCSO and the entities using the Courthouse in order to eliminate false alarms through system and security awareness training; and
- maintain monthly and yearly statistics for reporting purposes; and
- assist the Judicial Services Section Commander, learning that position in order that he may fill that role as required in the Commander's absence.

## **2-536 VOLUNTEERS IN COMMUNITY SERVICE (VICS)**

The Volunteers In Community Service function is supervised by a civilian VICS Supervisor responsible to the Court Security Supervisor. This component is comprised of civilian support staff and is tasked with all duties associated with alternative sentencing programs.

### **2-536.1 COURT SECURITY OFFICER**

This position is staffed by a special class of sworn officers hired and assigned specifically to provide courthouse, courtroom, and general judicial security. These officers are sworn deputy sheriffs with all associated powers. The powers of these officers are limited, however, by the Sheriff, to be used only during those times when the officer is actually assigned to perform judicial security work or in traveling directly to and from work. At all other times, these officers are prohibited from carrying Agency firearms or firearms in any capacity not available to ordinary citizens, and using their powers of arrest, or acting in any other official capacity.

Court Security Officers are prohibited from wearing their uniforms during non-duty hours, except when traveling directly from their residences to their assigned duties and returning directly to their residences upon completion of their assigned duties. Court Security Officers are prohibited from working in any capacity other than for the Sheriff while wearing their Charles County Sheriff's Office uniforms. Court Security Officers may not work for any employer, other than the Charles County Sheriff, where their sworn powers are to be used or could reasonably be expected to be used.

Court Security Officers are civilian employees for the purpose of pay, retirement, disability, or any other benefit matter. Court Security Officers working part-time are not entitled to any benefit other than those provided for part-time civilian employees. Part-time Court Security Officers work at will per the assignment of the Judicial Security Unit Supervisor or Coordinator and have no guaranteed minimum number of work hours.

#### **2-536.1.1 COURT SECURITY OFFICER FIELD TRAINING PROGRAM**

The successful completion of the Field Training Officer (FTO) Program is required of every new hire/lateral officer.



**Administrative and Operational Manual**

**September 12, 2022**

The Field Training Officer Program is based on the essential functions of a Court Security Officer and is meant to ensure each officer will have received the necessary training, supervision and guidance under actual working conditions to meet the high standards of the Agency.

**2-536.1.2 COURT SECURITY FTO PROGRAM RESPONSIBILITY**

The Court Security FTO Coordinator will be selected by the Commander, Judicial Services and will usually be a sergeant assigned to the Court and Judicial Security Unit. The FTO Coordinator is responsible for the overall daily operation and administration of this program. Specific responsibilities of the FTO Coordinator include maintaining all necessary records, ensuring current curriculum, providing for specified training and acting as a liaison with the Training Division. The FTO Coordinator will also be responsible for the selection and training of FTOs for this program. Details of this program can be found in the Courts and Judicial Security Unit SOP.

**2-536.1.3 COURT SECURITY FTO PROGRAM DESCRIPTION**

The Court Security FTO Program requires systematic and organized activities that educate and train newly hired/lateral officers. The program consists of on-the-job training, instructional training and numerous evaluation throughout the process. The program is designed to replicate those conditions a Court Security Officer will be presented with when performing in a solo status.

Court Security Officers are required to successfully complete a minimum number of hours based upon the police certification. Lateral officers, previously certified in Maryland must complete a minimum of 80 hours in a certified FTO Program. Comparative Compliance officers must complete a minimum of 160 hours in a certified FTO Program. Additional hours may be required to successfully complete the FTO program but no training program should exceed 240 hours.

**2-536.2 COURTHOUSE SECURITY AIDE**

The courthouse security aide is a part-time civilian position. The security aide is unarmed, poses no custodial authority, and does not have powers of arrest. The position is assigned to the courthouse to assist the sworn courthouse security officers with the day-to-day security operations of the courthouse. The security aide wears Agency issued civilian attire as described in this Manual.

**2-536.3 DUTIES OF COURTHOUSE SECURITY AIDE**

The courthouse security aide assists sworn officers with the process of screening visitors and searching property that is being brought into the courthouse (i.e., purses, briefcases, document binders, etc.). The aide will be responsible to check individuals who bypass the metal detection by making sure each individual has a valid pass to enter the courthouse. The aide will also assist with other duties as assigned by the courthouse security detail. The courthouse security aide will assist officers working in a courtroom that is in session. The aide will collect and distribute Agency mail throughout the courthouse at the discretion of the supervisor or courthouse coordinator. The aide will work a maximum of 24 hours a week and in some cases might not work the maximum hours if not needed.

**2-540 CHILD SUPPORT ENFORCEMENT UNIT**

Sworn officers assigned to Child Support Enforcement are responsible for the service of arrest warrants, attachments, summons, and other process relating to child support. They will provide security for the Domestic Relations court when it sits on child support matters. Sworn officers will assist the Unit Supervisor as needed and will be responsible for other duties as assigned.



**Administrative and Operational Manual**

**September 12, 2022**

**2-540.1 CHILD SUPPORT ENFORCEMENT UNIT SUPERVISOR**

The Child Support Enforcement Unit Supervisor is a sworn officer responsible for the daily operation of the Unit. The Supervisor will maintain monthly and yearly statistics for reporting purposes. The Supervisor will also maintain a close working relationship with the State Department of Human Resources Child Support Enforcement Administration, the local Department of Social Services, the Circuit Court for Charles County, the Master for Domestic Relations, and agencies and volunteer groups associated with child support enforcement. The Unit Supervisor will assist the Judicial Services Section Commander, learning that position in order that he may fill that role as required in the Commander's absence.

**2-540.2 CHILD SUPPORT ENFORCEMENT UNIT COORDINATOR**

The Child Support Enforcement Unit Coordinator is a civilian who is responsible to the Unit Supervisor. The Coordinator is responsible for data entry of all civil and criminal warrants / process received by this Agency that are child support related.

The Coordinator will enter, modify, clear, cancel, etc., civil and criminal warrants / process in the Agency computer system, METERS and NCIC. The Coordinator will prepare papers for entry by conducting inquiries of subjects named (i.e., local computer, MVA, Maryland raps, etc.). The Coordinator will maintain a close working relationship with the courts, the State Department of Human Resources Child Support Enforcement Administration, local Department of Social Services, and allied agencies, volunteer groups, and law enforcement agencies. The Coordinator will assist the Unit Supervisor with monthly and yearly statistics for reporting purposes, and as otherwise needed.

**2-540.3 CHILD SUPPORT ENFORCEMENT UNIT WARRANT SPECIALIST**

The Child Support Enforcement Unit Warrant Specialist is a civilian responsible to the Unit Supervisor. The Specialist will enter, clear, cancel, or otherwise update civil and criminal warrants / process in the Agency computer system, METERS, and NCIC. The Specialist will prepare papers for entry by conducting inquiries of subjects named (i.e., local computer, MVA, Maryland raps, etc.). The Specialist will maintain a close working relationship with the courts, the State Department of Human Resources Child Support Enforcement Administration, local Department of Social Services, and allied agencies, volunteer groups, and law enforcement agencies.

**2-540.4 CHILD SUPPORT ENFORCEMENT UNIT CIVIL PROCESS SERVER SPECIALIST**

The Child Support Enforcement Unit Civil Process Server Specialist is a civilian responsible to the Unit Supervisor. The Process Server Specialist will have the primary responsibility for the service of all child support related summonses. The Process Server Specialist will receive the process from the Child Support Enforcement Unit Warrant Specialist and using all available resources and established investigative techniques, attempt to serve this process. The Process Server Specialist will keep appropriate records of all activities related to the attempted service and service of summonses and make appropriate returns before returning the process to the courts. The Process Server Specialist will attempt to re-locate an individual who has moved and cause updating of all information relative to child support enforcement. The Process Server Specialist will not participate in the service of any document which requires arrest powers. Civilian Process Server Specialists have the rights and privileges granted to ordinary citizens, and as such are not prohibited to take such action as could any ordinary citizen. This would include the right to defend themselves from attack to the degree that any citizen would be able to defend themselves or another. The carrying of weapons is authorized only as stated in HR-218.

**2-540.5 CHILD SUPPORT COURT OFFICER**



**Administrative and Operational Manual**

**September 12, 2022**

The Child Support Court Officer is a sworn officer who is primarily responsible to provide security within the Charles County Courthouse relating to child support matters. The duties of this position include:

- assisting with the transportation of prisoners to and from the Court Holding Facility just outside the courthouse for court hearing; and
- checking for any weapons or other illegal items normally prohibited from the courtroom such as knives, scissors, drugs, tape recorders, etc.; and
- handling all the necessary paperwork which follows each prisoner; and
- escorting prisoners to offices as needed to sign necessary paperwork; and
- working warrants and writs of attachment; and
- participating with other child support officers in attempting to locate individuals wanted in child support matters.

Child Support Officers are grant-funded and serve child support papers only.

## **2-550      COMMANDER, PROPERTY MANAGEMENT**

The Commander, Property Management Section is responsible for the management of the Agency's fleet of vehicles and facilities (except Detention Center buildings). Vehicles shall include any and all motorized conveyances and/or vessels, operated by Agency personnel, any associated trailers or equipment related to those vehicles or vessels, and Agency bicycles. The Commander is responsible for all vehicles seized by the Agency in reference to CDS arrests. He manages the impound lot and the release of seized vehicles. In this regard, the Commander shall provide for:

- vehicle procurement, including any vehicle procured through any funding source;
- vehicle disposition;
- vehicle insurance;
- vehicle maintenance and repairs;
- the handling of administrative functions regarding vehicle crashes; and
- the coordination of repair of collision damage to Agency vehicles.

In the case of special vehicles and/or those procured through grants or any funding source, the Commander may assign the task of acquisition to the Fleet Manager, or work in conjunction with another designated person who may have the necessary technical knowledge and expertise related to a special vehicle.

The Commander of Property Management will work with the requesting division representative to ensure all needs are met in the acquisition. At a minimum, the funding source, type of vehicle, and necessary options need to be identified. Ample lead time must be given to acquire the vehicle in order to research and meet the requirements given.

Once the vehicle has been acquired, it will remain under the control of the Commander of Property Management until it is titled, tagged, and insured prior to the vehicle being issued. The Commander of Property Management will also ensure any specialized training or license certification relating to the specialized vehicle has been accomplished prior to the issuance of the vehicle.

The Commander of Property Management shall also be responsible for:

- arranging and coordinating with vendors, Charles County Public Facilities personnel and Agency employees for all repairs, renovations and/or additions to Agency owned or operated facilities;



**Administrative and Operational Manual**

**September 12, 2022**

- managing Agency alarm systems, coordinating installation and removal of alarm systems, and keeping Charles County's False Alarm Reduction Unit (FARU) informational requests and renewals current;
- providing certificates of liability insurance to any person or entity making such a request as a result of the Agency's use of that individual's or entity's property or facility; and
- managing all current and new locking systems as well as maintaining a central repository for all Agency door / alarm keys and codes.

Additionally, the Commander shall manage the supply functions of the Agency and the security and disposition of the property held by the Agency by his supervision of the Quartermaster and Property Custodians. The Commander must maintain all the records and files associated with these functions and ensure that the Agency is supplied in a timely fashion, having most items on hand when they are needed. The Commander should have ready supply channels for those items which are not stocked and be able to obtain them in short order. The Commander must maintain the security of all property recovered or stored by the Agency in the course of its operations. He must provide for the proper disposal of items as is appropriate and lawful. The Commander further has responsibility for administering Agency facility security policies, Agency keys, passes, and alarms (exclusive of CDC and court holding).

## **2-551 PROPERTY HELD OFFICER**

The Property Held Officer is a sworn officer responsible to the Commander, Property Management and will coordinate with the Civilian Property Held Custodian for the receipt, storage, security and disposal of property recovered, found, confiscated or held as a result of the activities of the Agency. This property includes controlled dangerous substances seized in connection with CDS / gambling / vice investigations. The property which is the object of the Property Held Officer's activities is that of outside persons or entities which has come under the control of the Agency as a result of its legitimate activities.

The Property Held Officer will be responsible to transport CDS from the Agency vault to the laboratory approved for analysis of such evidence if out of County or release CDS to Agency personnel for analysis. The Property Held Officer is assigned to assist in the retrieval of such analyzed CDS, and its return to the Agency drug vault.

The Property Held Officer must secure and inventory property in such a manner as to maintain not only the safety of that property from loss, but to the degree that the chain of custody of items is maintained as necessary for production as evidence in court hearings. The Property Held Officer shall maintain records which will allow him to determine when an item is no longer needed for evidence purposes.

The Property Held Officer shall dispose of CDS held on a regular basis in a manner consistent with law and/or Agency policy and coordinate all other disposals with the Property Held Custodian. The Property Held Officer shall ensure that no property is kept beyond the length of time required by law or beyond the time for which it is needed as evidence.

The Property Held Officer shall provide a complete inventory of all CDS within his custody each January and July, and coordinate with the Property Held Custodian for a complete inventory of all other property. The report of the inventories is due and shall be forwarded to the Commander, Special Services Division, by January 31 and July 31 respectively.

### **2-551.1 PROPERTY HELD CUSTODIAN**

The Property Held Custodian is a civilian responsible to the Commander, Property Management and will oversee the receipt, storage, security, and disposal of property recovered, found, confiscated, or held as a result of the activities of the Agency. This property does not include controlled dangerous substances seized in connection with CDS / gambling / vice cases or the supplies, equipment, and the like which are under ownership of the Agency.



**Administrative and Operational Manual**

**September 12, 2022**

The property which is the object of the Property Held Custodian's activities is that of outside persons or entities which has come under the control of the Agency as a result of its legitimate activities.

The Property Held Custodian may be assigned to assist in the transportation of CDS from the Agency vault to the laboratory approved for analysis of such evidence. The Property Held Custodian may also be assigned to assist in the retrieval of such analyzed CDS and its return to the Agency drug vault.

The Property Held Custodian must secure and inventory property in such a manner as to maintain not only the safety of that property from loss, but to the degree that the chain of custody of items is maintained as necessary for production as evidence in court hearings. The Property Held Custodian shall maintain records which will allow him to determine when an item is no longer needed for evidence purposes.

The Property Held Custodian shall dispose of property held on a regular basis in a manner consistent with law and/or Agency policy and deposit such monies as may be received from that disposition in accounts as required by law and/or Agency Policy. The Property Held Custodian shall ensure that property is not kept beyond the length of time required by law or beyond the time for which it is needed as evidence.

The Property Held Custodian shall conduct a complete inventory of all property within his custody each January and July. The report of that inventory is due and shall be forwarded to the Commander, Special Services Division, by January 31 and July 31 respectively.

**2-552 FIREARMS TRACKING SPECIALIST**

The Firearms Tracking Specialist is a civilian responsible to the Commander, Property Management, and will oversee the receipt, security, and disposal of firearms recovered, found, held for safekeeping, or held as a result of other activities of this Agency. The firearms which are the object of the Firearms Tracking Specialist's assignment are those of outside persons or entities which have come under the control of the Charles County Sheriff's Office as a result of its legitimate activities, and may also include firearms which have been placed into lawful service of the Agency and used as training aids related to the handling, identification, and packaging of recovered firearms.

The Firearms Tracking Specialist must secure and inventory in such a manner as to maintain not only the safety of the firearms from loss, but to the degree that the chain of custody of items is maintained as necessary for production as evidence in court hearings. The Firearms Tracking Specialist shall maintain records which will allow him to determine when an item is no longer needed for evidentiary purposes.

The Firearms Tracking Specialist shall dispose of firearms on a regular basis in a manner consistent with law and/or Agency policy.

The Firearms Tracking Specialist shall ensure firearms are not kept beyond the length of time required by law or for which they may be needed as evidence.

The Firearms Tracking Specialist shall conduct a complete inventory of all firearms within his custody during January and July of each year. A report of those inventories is due and shall be forwarded to the Commander, Special Services Division through the Commander, Property Management no later than January 31 and July 31, respectively.

**2-553 QUARTERMASTER**

The Quartermaster is responsible for the supply of Agency authorized uniforms, equipment, and supplies. The Quartermaster will requisition, store, and inventory all uniforms and associated items used by Agency personnel. He shall control the distribution and disposal of these items in a manner consistent with Agency policy.

The Quartermaster shall requisition and inventory all supplies and equipment used by components of the Agency where it is necessary to have stocks on hand or when there is a significant saving involved in bulk purchases. The Quartermaster shall control and distribute these items in accordance with Agency policy with the assistance of the





Administrative and Operational Manual

September 12, 2022

Quartermaster Specialists and Procurement Specialist. The Quartermaster, with the assistance of the Quartermaster Inventory Specialist, shall prepare and cause to be distributed to, Deputy Director, Accounting monthly inventory reports.

### 2-553.1 QUARtermaster INVENTORY SPECIALIST

The Quartermaster Inventory Specialist performs work relative to the office receipt and/or disbursement of items purchased through the Fleet purchasing system, entering data into the various computer systems, compiling monthly and yearly inventory reports, answering the telephone, updating and maintaining files, records, reports, and providing clerical support. The employee receives supervision from, and reports directly to, the Quartermaster.

### 2-554 PROCUREMENT SPECIALIST

The Procurement Specialist is a civilian responsible to the Quartermaster. The employee receives supervision from, and reports directly to, the Quartermaster. The Procurement Specialist is to assist the Quartermaster with the purchasing process and procure high quality goods and services for the best value. Most purchases are done through a comprehensive system of specifications and competitive bidding. The Procurement Specialist will communicate with vendors, contractors, and consulting firms regarding bids and RFPs for materials, equipment, supplies, and services required.

### 2-555 FLEET MANAGER

The Fleet Manager is the primary contact for vendors concerning all issues relating to vehicle management and repair or service. If the Fleet Manager is not readily available, the Commander, Property Management shall be contacted.

The Agency Fleet Manager is responsible for management of vehicles and, in addition to other duties specified in his position description, and elsewhere, will:

- conduct an ongoing inventory and advise the Commander, Property Management of vehicles to be replaced, and number of vehicles to be purchased;
- prepare bids;
- coordinate all title and insurance work;
- monitor care and maintenance of vehicles;
- coordinate repairs of damaged vehicles;
- coordinate the purchase and installation of all related vehicle equipment;
- approve invoices related to vehicle services for payment, prepare requisitions as needed, and coordinate with the Fleet Inventory Specialist to ensure proper accounting;
- coordinate the distribution of gasoline credit cards;
- monitor the use and condition of vehicles;
- maintain a computer database to record and track required information necessary for effective fleet management;
- make reports to the Commander, Property Management concerning any activities which may jeopardize



**Administrative and Operational Manual**

**September 12, 2022**

the investment represented by a vehicle, which is not being properly maintained, serviced or cared for;

- complete such other duties as may impact directly on the efficient operation of the Agency fleet;
- ensure compliance with VEIP inspections for all Agency vehicles; and
- ensure the completion of the required 80,000-mile Maryland State Inspection of all vehicles which are in service when reaching 80,000 miles.

### **2-555.1 FLEET SERVICES TECHNICIAN SPECIALIST**

The employee in this position will oversee, assemble, troubleshoot, and repair all Agency installed vehicle equipment. He is responsible for the complete building of emergency police vehicles and is the primary repair source for any electronic components installed by the Agency. The Technician Specialist is the senior employee in this area and may delegate work, address safety problems, and will be responsible for all work performed at this location. He will also inspect and may reject work performed by contracted vendors that fail to meet appropriate quality standards. The employee receives supervision from, and reports directly to, the Commander, Property Management.

### **2-555.2 FLEET INVENTORY SPECIALIST**

The Fleet Inventory Specialist performs work relative to the office receipt and/or disbursement of items purchased through the Fleet purchasing system, entering data into the various computer systems, compiling monthly and yearly inventory reports, answering the telephone, updating and maintaining files, records, reports, and providing clerical support. The employee receives supervision from, and reports directly to, the Commander, Property Management.

### **2-555.3 FLEET SERVICES TECHNICIAN**

This employee serves as an assistant to the Technician Specialist and generally performs routine repair work as needed. He will perform vehicle disassembly to vehicles that have been removed from service, assist in preparatory work with new vehicle assembly, and perform minor mechanical repairs. Technical electronic repairs or installs are permitted under the direction and guidance of the Technician specialist. The employee receives supervision from, and reports directly to, the Commander, Property Management.

### **2-556 AGENCY FACILITIES MANAGER**

The Agency Facilities Manager is responsible for the maintenance and daily operations of the Agency's building facilities / physical plants, and equipment; exceptions will be the CCDDC, Detention Center Annex, and Court Holding facility. The employee is responsible for all maintenance and building management issues at assigned facilities, as well as the lease agreements for all satellite facilities that require service. The employee receives supervision from, and reports directly to, the Commander, Property Management Section.

### **2-600 SUPPORT SERVICES DIVISION**

Support Services Division is the information management segment of the Agency. This division is responsible for the management of information processing regarding:

- requests for services;
- how calls are handled and cleared;
- investigations;



**Administrative and Operational Manual**

**September 12, 2022**

- complainants, victims, suspects, persons arrested; and
- other law enforcement agency activities, etc.

This responsibility encompasses all procedures, hardware, and software used by the other divisions of the Agency, including computer, voice communication, and data transmission systems. The Support Services Division provides critical support to all other divisions in the proper handling of the information used to track Agency response to the needs of the community at large. This includes data entry, storage, and retrieval.

- other law enforcement agency activities, etc.

This responsibility encompasses all procedures, hardware, and software used by the other divisions of the Agency, including computer, voice communication, and data transmission systems. The Support Services Division provides critical support to all other divisions in the proper handling of the information used to track Agency response to the needs of the community at large. This includes data entry, storage, and retrieval.

## **2-600.1 ORGANIZATION OF THE DIVISION**

The Support Services Division is comprised of the Communications Section and the Records Management Section.

### **2-601 SUPPORT SERVICES DIVISION COMMANDER**

The Support Services Division Commander is a sworn officer who is directly responsible to the Assistant Sheriff of Administration. The Commander is responsible for the direct supervision of subordinate commanders and the performance of administrative duties pertaining to the daily operation of the division. He is responsible for the performance of all personnel assigned to his command.

The Support Services Division Commander shall be responsible for maintaining Agency information and records systems, Agency communications systems, and the equipment associated with that function.

The Support Services Division Commander shall inspect the personnel, equipment, facilities, and other resources assigned to his command on a regular basis. He shall be responsible for maintaining these elements of his command in compliance with the policies set forth in this Manual and in other official directives of the Agency.

### **2-610 COMMUNICATIONS SECTION**

The Communications Section Commander is a sworn officer who is responsible to the Support Services Division Commander. The Commander, Communications Section is responsible for direct supervision of the Police Station Supervisors and the Police Communications Supervisors. The Commander is responsible for all radio and other communications devices used by the Agency, with the exception of specialized devices used in vice / intelligence operations.

### **2-611 COMMUNICATIONS SECRETARY**

This non-critical position provides a variety of clerical and administrative support services relative to the operation of the Communications Section. Assignments are carried out in accordance with general work instructions and established office practices and procedures. The employee receives supervision from, and reports directly to, the Commander, Communications Section. Work is evaluated through observations, conferences, and reports.

### **2-613 POLICE COMMUNICATIONS OFFICER (PCO) SUPERVISOR**

The Police Communications Officer Supervisor, a first-line supervisory position, is responsible for the day-to-day



Administrative and Operational Manual

September 12, 2022

operation of a particular shift of Police Communications Officers (PCOs). The PCO Supervisor must ensure that his particular shift is staffed to properly handle the anticipated work load. The PCO Supervisor must ensure that all calls for service are received and routed in an efficient manner. The supervisor must approve / disapprove leave requests, train and evaluate subordinates, and interact with other components of the Agency. The PCO Supervisor is responsible to the Communications Section Commander.

### 2-613.1 POLICE COMMUNICATIONS OFFICER (PCO)

The Police Communications Officer (PCO), a civilian, is responsible for the reception and proper handling of all calls for service. The PCO must use the radio, computer, telephone, and data communications devices of the Agency to provide support of other Agency personnel. They shall have access through various printed materials and Agency computers to directories of community services, duty rosters, and contact information for all Agency personnel. The PCO must be calm under the intense pressure of handling urgent situations and be able to handle the task of radio and telephone communications, while at the same time operating computer entry and retrieval devices. This position requires 24 hours per day, 7 days per week shift work. The PCO must maintain geographical and situational awareness of all assets available to respond to or participate in activities of the Agency.

### 2-614 POLICE STATION SUPERVISOR

The Police Station Supervisor is a civilian directly responsible to the Commander, Communications. The Police Station Supervisor, a first-line supervisory position, is responsible for the day-to-day operations of a particular shift of police station technicians, to include scheduling, performance ratings, and duties as described in the position description maintained in the Agency's Human Resources Section.

#### 2-614.1 POLICE STATION TECHNICIANS

The Police Station Technician position is non-sworn. This position requires 24 hours per day, 7 days per week shift work. The technicians shall be knowledgeable in the use of standard office equipment, machines, and the CAD and METERS systems. They shall have access through various printed materials and Agency computers to directories of community services, duty rosters, and contact information for all Agency personnel. Police Station Technicians shall also:

- serve as receptionists for callers and visitors;
- serve as call takers for non-emergency calls for service and for overflow emergency calls;
- obtain all pertinent and relevant information and enter appropriate information in the Agency CAD system;
- treat all callers with respect, courtesy, and sensitivity;
- be especially responsive to the needs of crime victims / witnesses and monitor victim / witness calls carefully to ensure that the response is appropriate to the circumstances;
- carefully assess calls requesting information about victim / witness assistance to ensure that there is no emergency, and if an emergency response is necessary, indicate in the CAD system that an officer shall be dispatched;
- provide referral information to victims / witnesses in need of medical attention, counseling, and emergency financial assistance;
- perform METERS functions;



**Administrative and Operational Manual**

**September 12, 2022**

- prepare daily transmittal of citations; and
- perform other duties as assigned by the Commander, Communications.

## **2-620 RECORDS MANAGEMENT SECTION**

The Deputy Director, Records Management Section is directly responsible to the Commander, Support Services Division. The Deputy Director is the "Custodian of Records." The Deputy Director shall be responsible for oversight and management of all record-keeping functions, and evaluates and counsels the Records Supervisor, and disciplines subordinates.

This includes the gathering and storage of information concerning calls for service, investigations, persons, photographs, administrative files, etc. At a minimum, the Deputy Director will maintain records of service calls and crimes by type and location, and will maintain records of all stolen, found, recovered, and evidentiary property. In some cases, the physical storage of information may be handled by another component of the Agency. In these cases, the Deputy Director shall institute policies and procedures through the AOM or by the creation of an Agency Records Manual which controls the process of gathering, storing, handling, retention, and disposal of that information.

The Deputy Director, Records Management Section shall be the authority for the disposal of any record or files and will establish time tables for the retention and disposal of various types of records and files. The Deputy Director, Records Management Section is responsible for the lawful expungement of records.

## **2-621 RECORDS MANAGEMENT SUPERVISOR**

The civilian Records Management Supervisor coordinates the daily operations of the Records Management Section by dissemination of daily assignments to each data entry clerk. The Records Section reviews each offense / incident report generated by each officer to assure proper classification and coding for uniform crime reporting. He gathers all statistics from the police records technicians and prepares the final report form and forwards them to the Maryland Department of State Police. The supervisor trains, evaluates, counsels, and disciplines the assigned personnel in accordance with Agency policy and procedures. He performs other related work and special assignments as directed by the Deputy Director, Records Management Section.

## **2-622 POLICE RECORDS TECHNICIANS**

Civilian Police Records Technicians assigned to the Records Management Section are responsible for the processing of all materials entering the section. This includes:

- processing all reports as instructed in the Records SOP;
- filing;
- computer data entry and generation of computer copies;
- faxing;
- copying;
- coordination and preparation of files for various law enforcement agencies and other criminal justice agencies;
- maintenance and tracking reports received;
- coding and classification of reports for UCR reporting;
- records checks;
- HIT responses and METERS entries; and
- preparing the Agency U.S. mail for pickup.

Police records technicians perform other related work and special assignments delegated by the Records



Administrative and Operational Manual

September 12, 2022

Supervisor and/or the Deputy Director as needed.

## 2-623 OFFICE ASSOCIATE

The part-time Office Associate position is held by a civilian. This position is responsible to the Records Management Supervisor or Deputy Director. Personnel assigned to this position will perform various clerical duties to include:

- filing;
- answering telephones and taking messages;
- answering Agency related questions;
- receiving and routing Agency mail;
- walk-in records checks;
- logging in, faxing reports, and distributing all faxes;
- handling expungements;
- computer data entry; and
- other duties as assigned by the Records Management Supervisor.

## 2-700 INFORMATION TECHNOLOGY DIVISION (ITD)

The ITD is commanded by a civilian director, who reports directly to the Assistant Sheriff of Administration. The Director of ITD is responsible for ensuring the ITD is responsive to the needs of the Agency and the overall management of the ITD.

### 2-731 DIRECTOR, ITD

The Director, ITD, is a civilian who reports to the Assistant Sheriff, Administration and is responsible for all hardware, software, network communications links, and the processing of information within the Agency and, in certain areas, the processing of information outside the Agency. This responsibility includes:

- acquisition and maintenance of hardware and software systems;
- continued review of applicability of existing information systems;
- exploration of new technologies that would enhance the efficiency of Agency information systems;
- oversight of the use of all information systems within the Agency;
- creation of user manuals or acquisition of existing manuals;
- maintenance of all hardware and software systems either through ITD personnel or outside contractors;
- maintenance of all data communication links and network hardware and software;
- creation and/or modification of software used within the Agency;
- satisfaction of requests for statistical data;
- upkeep of the Agency website and development and use of an in-house Intranet site; and
- response to user calls for service and technical problem resolution on a 24-hour, 7-day basis.

### 2-732 SYSTEMS OPERATIONS MANAGER

The position of Systems Operations Manager is held by a civilian tasked with supervision of the Systems Operations Section and all of the critical network and server hardware and software systems within the Agency.

### 2-733 SYSTEMS OPERATIONS UNIT

The Systems Operations Section consists of the civilian positions of Network Specialist, Database Administrator, and Network Applications Specialist. These positions report to the Systems Operations Manager. This Unit is



**Administrative and Operational Manual**

**September 12, 2022**

responsible for all network hardware and software applications, to include:

- oversight of the network LAN and WAN connections;
- administration of the network software;
- administration of the network user population;
- maintenance of the network devices;
- establishment of new network connections;
- monitoring network use and identification of bottlenecks;
- maintenance and support of the UNIX servers;
- evaluation of new technologies; and
- administration of network backup systems.

**2-733.1 NETWORK SPECIALIST**

The position of Network Specialist is held by a civilian tasked with, in coordination with the Systems Operations Manager, supervision of the critical network infrastructure within the Agency.

**2-733.2 DATABASE ADMINISTRATOR**

The Database Administrator, a civilian, is responsible for the maintenance of all database applications used by the Agency other than the CAD / RMS databases. This position is responsible for the creation, ongoing maintenance, and support of all applications using the databases. This position is also responsible for the ongoing maintenance of the Agency's Intranet and internet sites.

**2-734 APPLICATIONS MANAGER**

The Applications Manager is a civilian tasked with supervision of the Applications Section with responsibility for:

- interaction with the software vendor concerning problems and enhancements;
- interaction with system users including resolution of problems, training, and documentation;
- development of ad-hoc reports;
- continued assessment and audit of system security issues; and
- evaluation of upgrades and/or new software products that would benefit the Agency.

**2-735 APPLICATIONS SECTION**

The Applications Section is responsible for the maintenance of the software used by the Agency and other allied agencies with respect to our computerized records for police calls and reports. This Unit works closely with personnel who utilize this software in the following areas:

- Police communications and the County 911 Fire and EMS in Computer Aided Dispatch;
- Police Station Technicians at the district stations in calls for service start up and tracking;
- Records, Narcotics, and CID in Records Management;
- Civil and warrant units in civil process and warrant tracking;
- Child Support Enforcement Unit;
- the Detention Center in arrest processing and jail intake and inmate tracking;
- Patrol operations and community policing; and
- the PC-based office software used throughout the Agency.

**2-735.1 SYSTEMS ANALYST**

The position of Systems Analyst is held by a civilian responsible to the Applications Section. The Analyst will perform



**Administrative and Operational Manual**

**September 12, 2022**

duties as indicated in the position description maintained in the Agency's Human Resources Section and other duties as assigned.

## **2-737 TECHNICAL SUPPORT MANAGER**

The position of Technical Support Manager is held by a civilian tasked with supervision of the Technical Support Section with responsibility for:

- establishment of PC operational procedures;
- all PC installations and movements within the Agency;
- keeping abreast of all improvements in hardware and software;
- interaction with the software and hardware vendors concerning problems and technology enhancements;
- interaction with PC users including resolution of problems, training and documentation;
- PC software and hardware inventory; and
- continued assessment and audit of system security issues.

## **2-738 TECHNICAL SUPPORT SECTION**

The Technical Support Section is overseen by the Technical Support Manager. The Technical Support Section is responsible for all PC hardware, software, and related peripherals such as printers, scanners, etc.

## **2-739 TECHNICAL SUPPORT SPECIALIST**

The Technical Support Specialists are responsible to the Technical Support Manager. The Technical Support Specialists will perform duties as indicated in the position description maintained in the Agency's Human Resources Section and other duties as assigned.

### **2-740.1 IT ADMINISTRATIVE SUPPORT SPECIALIST**

The position of IT Administrative Support Specialist is held by a civilian reporting directly to the Director, ITD, and providing support to all the units within ITD in the following areas:

- administration of the ITD Help Desk;
- coordination of the work order responses to the user population;
- assistance with creation of documentation; and
- tracking of requisitions and purchase orders used by ITD.

## **2-800 TRAINING DIVISION**

The Training Division has direct responsibility for the overall management of all Agency training, even though some training programs are sponsored, conducted, or administered by other entities.

### **2-800.1 ORGANIZATION OF TRAINING DIVISION**

The Commander, Training Division manages this division. The component is comprised of sworn Agency training personnel, the Training Specialist, Agency personnel assigned to the Southern Maryland Criminal Justice Academy (SMCJA), the Cadet program, and the Firearms Instruction Detail.

### **2-801 TRAINING DIVISION COMMANDER**





**Administrative and Operational Manual**

**September 12, 2022**

---

The Training Division is commanded by a sworn Captain who reports directly to the Assistant Sheriff of Administration. The Commander is responsible for the direct supervision of subordinate commanders and the performance of administrative duties pertaining to the daily operation of the division. He is responsible for the performance of all personnel assigned to this command. The Training Division Commander shall inspect the personnel, equipment, facilities, and other resources assigned to his command on a regular basis. He shall be responsible for maintaining these elements of his command in compliance with the policies set forth in this Manual and in other official directives of the Agency.



Administrative and Operational Manual

September 12, 2022

## **2-805 SOUTHERN MARYLAND CRIMINAL JUSTICE ACADEMY**

The Southern Maryland Criminal Justice Academy (SMCJA) is an institution supported by the Agency through monetary payments and dedication of personnel. It is the institution of choice for mandated sworn and correctional officer entry level training.

The Commander of the SMCJA is responsible to the Sheriffs of Charles, St. Mary's, and Calvert counties collectively for the operation of this institution. However, the personnel assigned from the Charles County Sheriff's Office to staff the institution are assigned to the Training Division.

The Assistant Sheriff of Administration will monitor the activities of the personnel assigned to the SMCJA and determine that their job performance is to the credit of the Agency. He will assist the Sheriff in maintaining an awareness of the programs and operations of the SMCJA.

### **2-805.1 TRAINING COORDINATOR**

The Training Coordinator is a civilian responsible to the Commander SMCJA with responsibility for:

- Instructing annual in-service training, as well as entrance level training for both correctional and law enforcement officer programs;
- Developing and conducting training programs to certify and qualify employees as mandated by the MPTSC.

### **2-805.2 TRAINING INSTRUCTOR**

Training instructors are sworn and part-time civilian positions responsible to the Commander, SMCJA with responsibility to:

- Instruct annual in-service training and entrance level training for both correctional and law enforcement officer programs;
- Develop and conduct training programs to certify and qualify employees as mandated by the MPTSC;
- Prepare teaching materials for new training programs; review, evaluate, and modify existing and proposed programs and recommend appropriate changes.

## **2-810 TRAINING SECTION**

The Commander, Training Section is a sworn Lieutenant who reports directly to the Commander, Training Division. The Commander, Training Section is charged with the responsibility of the continual evaluation of the Agency employee levels of knowledge, skills, and abilities (KSA) in relationship to the performance of tasks required of the employee as a result of the employee's position within the Agency. In this regard, the Commander must provide training opportunities which close any gap between KSA needed and those actually possessed.

### **2-810.1 SPECIFIC RESPONSIBILITIES**

Following is a list of some of the specific tasks assigned to the Training Section. The Commander will see that these and other associated responsibilities are managed to the benefit of the Agency and the citizens of Charles County.

- Training files will be maintained for each employee of the Agency, to include a record of each training program attended.



**Administrative and Operational Manual**

**September 12, 2022**

- 
- A record of each training program conducted by the Agency shall be maintained. This record will contain, at least, the course content (lesson plan), the names of attendees, and their association if they are from outside the Agency, and the performance of each attendee as measured by tests (if administered).
  - A record will be kept and an analysis made of funds expended to accomplish training in order to gain the greatest benefit-to-cost ratio.
  - There will be a monitoring process to determine that all required or mandated training is being accomplished.
  - There will be a continual search for the best training programs, methods, and techniques available to accomplish Agency training.
  - Support will be provided for the Agency Training Committee, and the Committee's recommendations will guide the Commander in choosing subject material for Agency training.
  - A master lesson plan file will be maintained for all training conducted by the Agency or at the direction of the Agency in any on-going format. This file will retain lesson plans for programs which have been discontinued or changed, maintaining the outdated plans for support of any future litigation regarding training. These lesson plans will contain at least:
    - a statement of performance and job-related objectives;
    - the content of the training and specifications of the appropriate instructional techniques;
    - a statement authorizing that the lesson plan is approved for a particular training purpose under the authority granted the Commander, Training Section; and
    - identification of any tests used in the training process and the acceptable score for receiving credit for successful completion of the program.
  - A remedial training policy is established and administered which is designed to ensure that any deficiencies noted in training or in actual performance of Agency tasks are identified and corrected.
  - Each new employee will be provided a training program concerning Agency policy, procedures, rules and regulations, to include testing of the employee's knowledge of the same.
  - Oversight will be maintained of new employee on-the-job training and in-service training, to include specialized training for all employees who may be promoted to new positions or duties.
  - Oversight of training necessary to assure compliance with the Agency's EEOC Plan will be maintained.

## **2-811 TRAINING PROGRAMS**

Employees are required to attend training programs which they are scheduled, or directed, to attend. All employees will be trained as required by any law or Agency directive regarding minimum training for their position. All levels of supervision are required to provide for employee training, at least to the minimum levels required by law, regulation, or policy of the Agency. This requirement is deemed to have been met by a supervisor if a Request for Training Form #181 has been forwarded to the Training Commander.

Supervisors and administrators will provide an immense contribution toward the career development of their subordinates. As required by MPTSC, newly promoted supervisors / administrators will attend an approved training course within a year's time frame of their date of promotion. Supervisors will also receive training in career counseling and career development. This training will increase their knowledge of techniques used in managing, counseling, and assessing their subordinates' skill levels, knowledge, and abilities.



**Administrative and Operational Manual**

**September 12, 2022**

Each employee who is responsible for conducting a training program, and the Training Commander, will develop for each program a method of dealing with excused absences of attendees at training programs. These methods could take the form of make-up classes, individual instruction, reading assignments, or such other methods as may qualify the employee to the levels required of attendees to the program. Employees who are scheduled to attend any program must notify the Training Commander, or the designated leader of the particular training program, as far in advance as possible, of any need to be absent from a training program or any portion thereof.

All levels of supervision will identify advanced training, beyond that required at entrance level, in order to enhance the performance of their subordinates. Recommendations for such training will be forwarded to the Training Commander for consideration. Division commanders will coordinate with the Training Commander any use of funds at the division level expended for training. Likewise, any training accomplished at the division level or below, both accomplished in-house, or received gratis from outside sources, will be reported. The Agency Form #182, Report of Training, will be used for this purpose.

**2-812. TRAINING ADVISORY COUNCIL**

The Charles County Sheriff's Office has established a standing committee within the Agency known as the Training Advisory Council. The Training Advisory Council is responsible, through the Training Commander, for identifying training priorities for the Agency and for the oversight of all training throughout the Agency, including the review of training related policies. The Council, in identifying training needs, shall take into consideration any information or suggestions obtained from citizen complaints, community meetings, citizen advisory committee meetings, personnel involved in internal investigations, and supervisory or command personnel.

The Council is composed of the Training Commander and one representative from each of the Agency divisions and the Office of General Counsel. The division representatives will be appointed by their respective division commanders or directors. If that selected representative is not available to attend a particular Training Advisory Council meeting because of an excused absence, the respective division commander should send a substitute to represent the division.

The Training Advisory Council will meet in a manner and/ or location as designated by the Training Commander. The Training Commander will send out notifications of dates and times of these meetings to the division commanders/ directors. Training personnel will ensure that these meetings occur at least biannually, with records of attendance and minutes of each meeting maintained and recorded in writing. A copy of the minutes for each meeting will be forwarded to all members of the Executive Staff.

During the first scheduled meeting each year, the Training Advisory Council will conduct a review of policy and training needs pertaining to active threats. The results of the annual active threat review will be documented in the meeting minutes. In conjunction with the regularly scheduled meetings of the Training Advisory Council, the Office of General Counsel; Commander, OPR; and the Training Commander shall meet to review incidences of use of force to determine any necessary changes in Agency training or policy.

**2-813 TRAINING SPECIALIST**

This civilian position involves a variety of clerical and administrative duties relative to the operation of the Training Division, specifically the Training Section. This employee serves as the receptionist for the Section, and handles all requests for training, registration, travel, expenses, and other related items. Specialized Agency training programs conducted or organized by the Agency are coordinated through this office. This position also serves as the Systems Administrator for the Agency online training website.

**2-814 FIREARMS INSTRUCTION DETAIL**

This Detail includes the firearms instructors, including the Agency Chief Firearms Instructor, who provide training to all personnel. This component is responsible to provide initial training, in-service training, and specialized training



**Administrative and Operational Manual**

**September 12, 2022**

to entry level, in-service level, and even retired level personnel. Instruction in handguns, rifles, shotguns, and special use weapons is required. The Chief Firearms Instructor will make sure that all requirements for Agency personnel to use firearms, both in policy and law, are complied with insofar as the administration of training can accomplish this.

## **2-815 CADET PROGRAM**

The Cadet Program is designed to provide qualified high school seniors and college students with the opportunity to serve in a uniformed auxiliary capacity. After serving a minimum of one year, they may be appointed as correctional or sworn officers. This program is under the direct supervision of the Training Commander.

Cadets may serve in any component of the Agency in order to gain knowledge and experience of as much of the Agency's operations as possible. During such assignments, they may report daily to a commander who is responsible for the component to which they are assigned. The overall responsibility for their performance, development, and evaluation remains with the Training Commander.

## **2-900 ADMINISTRATIVE SERVICES DIVISION**

The Administrative Services Division is managed by a sworn commander or civilian director who reports directly to the Assistant Sheriff of Administration. The Commander / Director, Administrative Services Division is responsible for overseeing the Agency's Budgeting and Accounting Sections and the Human Resources Section. The Commander / Director represents these sections during meetings with the Command Staff and the Sheriff. The Commander / Director is designated as the Agency's EEO Coordinator. The Commander / Director, in addition to the duties listed in the position description, is responsible for:

- providing guidance and assistance to the Deputy Directors within the division on various issues;
- overseeing the hiring process in order to hire and retain the best possible candidates to staff the various positions throughout the Agency;
- managing and overseeing the Agency's budget development, approval, and implementation;
- reviewing and approving the processes of background investigations, ensuring all legal requirements have been met;
- researching alternative methods of testing applicants, ensuring the Agency is current in its processes;
- acting as liaison between the Sheriff and Human Resources in order to assist the Sheriff with hiring decisions concerning police officers, corrections officers and higher level civilian positions;
- overseeing the process of promotion by forming committees, chairing meetings, and otherwise ensuring the validity of the entire process;
- controlling the re-evaluation of positions and their placement on pay scales;
- evaluating and researching the Agency's rate of pay for the various positions within the Agency's classification plan;
- developing and submitting the Division budget and controlling the use of the approved budget.

## **2-901 ACCOUNTING SECTION**



**Administrative and Operational Manual**

**September 12, 2022**

The Accounting Section is administered by a civilian Deputy Director, who reports to the Commander / Director, Administrative Services Division. In the absence of the Deputy Director, Budgeting Section, the Deputy Director, Accounting Section acts as the Sheriff's liaison with County Government finance personnel and outside auditors. Accounting is composed of four major areas: Accounts Payable, General Accounting, Payroll, and Inmate Accounting.

**2-902 PAYROLL**

The Accounting Section is responsible for processing the biweekly Payroll Change Notices and biweekly additional pay data entries received from the Agency timekeepers in accordance with the Charles County Government's Payroll office. This section also prepares and distributes the Agency Holiday and Paycheck schedules.

**2-903 CASH FUNDS**

The Accounting Section, in conjunction with division commanders and the Office of Professional Responsibility, is responsible for overseeing the maintenance of Agency cash fund accounts. Accounting shall maintain a record of all components or personnel who are authorized by the Sheriff to receive, maintain, or disburse cash.

**2-904 INMATE ACCOUNTING**

The Accounting Section is responsible for the review of the inmates' accounts and the related financial records and reports. This Section also prepares the bank reconciliations and related reports for both checking accounts at the Detention Center. In addition, the Accounting Section:

- reviews the inmates' accounts and the related financial records and reports;
- maintains and prepares revenues and expense spreadsheets for the special fund account;
- reviews expense accounts and reconciles accounts at the end of the month, requests check disbursements;
- reviews and reconciles the daily inmate count sheets, prepares and maintains the County spreadsheets;
- prepares monthly letters regarding unclaimed money and stale dated checks;
- prepares monthly bank account reconciliations and reports for the two bank accounts at the Detention Center;
- Audits deposits made by Administrative and Intake and verifies amounts with banking records; and
- prepares purchase orders from approved requisitions, for the special fund account.

Personnel assigned to the Accounting Section will be responsible to the Deputy Director, Accounting Section. Section personnel will be responsible for duties as indicated in the Position Description maintained by the Agency Human Resources Section and other duties as assigned.

**2-905 GRANT ACCOUNTING**

Grant Accounting prepares monthly and quarterly financial reports of federal, state, and local grant programs and projects, submits reports and documents to state and local granting agencies for reimbursement. Personnel attend meetings to review the fiscal request on the grants with the granting agencies, to provide additional explanation of our funding requests.



**Administrative and Operational Manual**

**September 12, 2022**

All original grant awards and copies of monthly, quarterly, or annual progress reports will be maintained within the Accounting master file, along with all financial information relating to a particular grant award. A complete file must be maintained within Accounting for yearly audit and inspection purposes.

## **2-910 BUDGETING SECTION**

The Budgeting Section is administered by a civilian Deputy Director, who reports to the Commander / Director, Administrative Services Division. The Deputy Director, Budgeting Section, acts as the Sheriff's liaison with County Government finance personnel and outside auditors.

The Budgeting Section is responsible for the management of the Agency budget process and the final budget preparation. All divisions within the Agency shall prepare and submit written budget recommendations to the Budgeting Section annually.

The Budgeting Section:

- administers the Agency's annual operating and capital budgets, including local and federal grants, and the financial analysis of the Agency's fiscal operations;
- provides the County with information regarding the Sheriff's Office capital improvement program and lease / purchase program;
- prepares monthly and quarterly management and budget reports;
- provides technical assistance to other Agency components to ensure the availability of funds and compliance with the Agency's accounting procedures;
- provides approved requisitions for purchase orders to be completed and distributed to appropriate individuals for ordering;
- prepares yearly projected expense and revenue budgets and meets with County Government personnel for annual budget requests;
- manages the development, implementation, and monitoring of the Agency's annual budget;
- provides timely and accurate financial analysis of the Agency's fiscal operations;
- maintains the monthly expenses and revenues for the Asset Forfeiture accounts following written guidelines;
- prepares monthly expense and revenue reports for SMCJA;
- prepares and maintains the master position control listing for the Agency;
- prepares and distributes the Agency pay scales;
- reviews all requests for financial appropriation from all operating units within the Agency;
- Reviews contracts and leases for financial appropriations.

## **2-911 ACCOUNTING SYSTEM**

The Agency's accounting system provides for computer records to be maintained of each account and the approval



**Administrative and Operational Manual**

**September 12, 2022**

of expenditures from those accounts. The Deputy Director, Budgeting Section will publish a quarterly status report to the Sheriff that includes:

- Initial appropriation for each account or program;
- Balances at the commencement of the monthly period;
- Expenditures and encumbrances made during the period; and
- Unencumbered balance.

**2-920 HUMAN RESOURCES SECTION**

The Deputy Director, Human Resources, is responsible to the Commander / Director, Administrative Services Division, and plans, organizes, and controls all activities of the Human Resources Section, including the Pre-Employment / Recruitment Unit. The Deputy Director is designated as the Agency Assistant Equal Employment Opportunity Coordinator (EEOC).

Personnel assigned to Human Resources will be responsible to the Deputy Director. Section personnel will be responsible for duties as indicated in the position description maintained by this Section, and other duties as assigned.

**2-921 PERSONNEL FUNCTIONS**

- Establishing and maintaining personnel records;
- Monitoring the accuracy of the employee personnel files;
- Monitoring the performance evaluation programs;
- Administering the Agency's grievance process;
- Administering classification programs, including the classifying and reclassifying of positions, and development and maintenance of a position description for each position within the personnel structure of the Agency, such position description to include:
  - a full explanation of the essential functions of the position;
  - a description of any pre-service and/or in-service training requirements for the position;
  - a method to certify that pre-service training requirements are met prior to the employee's assumption of the position; and
  - a method to ensure that documentation of all training requirements are placed in the personnel files of the employee.
- Providing information to the Accounting and Budgeting Sections concerning employment, terminations, and compensation;
- Administering time and attendance functions for the majority of Sheriff's Office employees;
- Monitoring benefits programs for all employment groups;
- Coordinating various educational benefit programs;
- Maintaining the computerized personnel program by entering and updating employee information;
- Scheduling and administering internal administrative tests for position upgrades and/or employee transfers;
- Producing and advertising all external job announcements;
- Receiving and filing employment applications;
- Entering applicant information into the Agency computerized personnel program;
- Reviewing all applications to determine eligibility;
- Organizing and scheduling various appropriate testing for all external candidates;
- Organizing the interview process for all internal and external candidates;
- Maintaining lists of eligible candidates for all positions;
- Maintaining contact with the applicant from the time the application is submitted to the final disposition of the application;





Administrative and Operational Manual

September 12, 2022

- Forwarding files of those applicants selected to continue in the process to Pre-Employment / Recruitment Unit;
- Notifying, by letter, those applicants not chosen and reason;
- Notifying applicants selected for employment and establishing the orientation date;
- Acting as the clearinghouse for all external inquiries regarding current and former employees;
- Acting as a liaison between employees and the insurance carrier for workers' compensation claims;
- Administering and coordinating employees' Family Medical Leave;
- Overseeing the Agency orientation and exit interview process, to include:
  - issuing to each new employee, upon their appointment, a current Agency Manual on a computer thumb-drive;
  - reviewing with each new employee the Agency's role, purpose, goals, policies, and procedures;
  - defining working conditions and regulations; and
  - explaining the responsibilities and rights of employees.
- Preparing EEOC annual reports and maintaining other records, reports, and logs to conform to EEOC regulations;
- Providing recommendations to Agency supervisors on various Human Resource related issues;
- Coordinating officers' certifications through the Maryland Police Training and Standards Commission;
- Acting as the liaison to the Maryland Police Training and Standards Commission; and
- Coordinating internal position testing.

## 2-922 PRE-EMPLOYMENT / RECRUITMENT

This unit is supervised by a civilian Background Supervisor and staffed by civilian background investigators who have prior police and human resources experience.

The unit's mission is to ensure that only the applicants with the highest level of integrity are awarded positions within the Agency. The objective of the recruitment plan shall be directed toward the goal of hiring the best available candidates, while achieving a work force that is representative of the demographic composition of the County. Pre-Employment / Recruitment personnel will regularly attend job fairs and career nights at schools, universities, and other locations, both in and out of the jurisdiction, in order to accomplish its goal of reaching out to as diverse a group of candidates as possible.

The pre-employment investigations process for Sworn and Corrections is conducted in accordance with mandated guidelines established by the Maryland Police Training and Standards Commission (MPTSC). All investigations are subject to Agency review on a continuing basis to ensure compliance and are also subject to external audit by state authorities at any time.

Those required elements of a background investigation include:

- a comprehensive investigation to determine that the applicant:
  - is of good moral character and reputation;
  - is emotionally stable; and
  - displays the behavior necessary to perform the duties of a police or correctional officer.
- a check of military records, when applicable, including obtaining a complete copy of the discharge document;
- a report from a credit agency regarding the applicant's current and past credit history;
- an examination of school records or interviews with school officials if the applicant attended school within



Administrative and Operational Manual

September 12, 2022

- 
- the last five years;
  - interviews of:
    - personal references furnished by the applicant;
    - neighbors at places of the applicant's residence within the past five years;
    - current and past employers within the last five years; and
    - coworkers within the last five years.
  - an investigation of the prior use of controlled dangerous substances by the applicant as specified by Regulation .19 of the MPTSC standards.

The background investigation is to determine whether the applicant is a loyal United States citizen and appears to be mentally, physically, and emotionally fit to perform law enforcement or corrections duties. Interviews may be conducted:

- In person;
- By telephone;
- By completion of an Agency form and questionnaire by the interviewer or person interviewed; and/or
- Using other methods designed to elicit useful information from a person to predict future job performance.
- Criminal record checks and fingerprints;
  - The Unit shall fingerprint the applicant and submit these records to the appropriate local, state, and national agencies for a search of criminal justice files;
  - A search may be performed through the National Criminal Information Center (NCIC) files in lieu of a local fingerprint check;
  - The Unit shall maintain records indicating the results of a record check.
- Driver's license and driver's history;
  - The applicant shall possess a valid driver's license;
  - Perform a check of the applicant's driving record and maintain a copy of the results.

The unit shall coordinate:

- Physical Examinations: A licensed physician shall perform a physical examination to determine whether the applicant is physically fit to perform the duties of a police or correctional officer;
- Mental Health Examinations: A licensed mental health care professional shall perform an examination to determine whether the candidate is emotionally and mentally fit for the duties of a police or correctional officer as determined by the Charles County Sheriff's Office;
- Drug Screening:
  - An applicant shall receive a drug screening to test for controlled substances;
  - The Agency shall maintain a record of the drug screening results.
- provide to the Commander / Director, Administrative Services recommendations concerning the applicants;
- maintain lists of applicants under investigation to include the disposition of each applicant;
- ensure the background investigation files are properly prepared for review by the Commander / Director, Administrative Services Division and for final approval by the Sheriff or his designee; and



Administrative and Operational Manual

September 12, 2022

- assist in the presentation of candidates for hire to the Sheriff.

## 2-923 RECRUITING PROCESS

The objective of the CCSO's recruitment plan shall be directed toward the goal of hiring the best available candidates while achieving a work force that is representative of the demographic composition of the County. In working toward this goal, the Commander / Director, Administrative Services shall, on a yearly basis, review statistics on the composition of the work force in the County. The Commander / Director shall maintain liaison and post job announcements with a diverse group of minority organizations that may assist in recruiting members of their groups for sworn positions within the Agency.

In addition, Pre-Employment / Recruitment personnel will regularly attend job fairs and career nights at schools, universities, and other locations, both in and out of the jurisdiction, in order to accomplish its goal of reaching out to as diverse a group of candidates as possible.

The Supervisor, Pre-employment / Recruitment will utilize both male and female minority officers to assist in recruiting efforts. Minority officers may attend recruiting functions to demonstrate the Agency's commitment to hire qualified minority applicants.

Personnel assigned to assist the Pre-employment / Recruitment Unit will assist Human Resources with the responsibility to provide for job announcements and recruitment notices for all available positions that provide an accurate job description and outline of duties, responsibilities, skills, educational levels, and other qualifications. Job announcements for sworn personnel will be posted with community service organizations, and the Agency will actively seek the cooperation of community organization leaders in recruiting qualified applicants.

Entry level job vacancies will be advertised in local newspapers and/or posted on various websites and media outlets by the Administrative Services Division. All announcements and advertisements will list the Agency as an equal opportunity employer and will provide for application deadlines.

## 2-924 ANALYSIS

The Commander / Director will periodically review work force composition statistics and applications for sworn positions to assess the effectiveness of the recruiting process. The Commander / Director will evaluate and revise the Agency's recruitment plan annually to better meet objectives.

# CHAPTER 3 – AGENCY ADMINISTRATION, UNIFORMS, AND APPEARANCE

## 3-100 AGENCY PERSONNEL SUBJECT TO SUMMONS OR SUBPOENA

### 3-100.1 DEFINITIONS

**Summons** – A summons is a command to appear in court directed to a defendant. Refer to AOM 3-658 for procedures relating to the receipt of a summons for civil litigation.

**Subpoena** – A subpoena is a command to appear in court to provide testimony, records, or both.

**Subpoena testificandum** – a subpoena to testify



Administrative and Operational Manual

September 12, 2022

**Subpoena duces tecum** – a subpoena to produce records. “Records” can include physical items such as evidence collected during an investigation.

### 3-100.2 SUBPOENAS

A subpoena can be served by a person over the age of 18 who is not a party to the case.

Unless a judge orders otherwise, a subpoena cannot command the production of records before a scheduled court hearing. Often, though, a subpoena will say that appearance at a hearing may be excused if the requested records are provided before the hearing. This is a courtesy for both sides; the party with the subpoena does not have to wait for the records, and the person in the subpoena does not have to go to court.

Any questions about a subpoena should be referred to the Office of General Counsel. The Office of General Counsel should be contacted about any subpoena that requests confidential or privileged material such as information contained in a personnel file or relating to a disciplinary investigation conducted by the Office of Professional Responsibility.

Employees, whether on- or off-duty, will accept any subpoena or other legal court or civil process which is served on them personally unless such service directly interferes with an immediate police operation or task. Employees are encouraged to make arrangements to receive service when service will not interfere with the employee’s duties. Supervisors will not take officers out of service to enable attorneys or process servers to serve civil subpoenas.

A District Court subpoena may be served by first class mail. All other subpoenas must be physically handed to the person named in the subpoena or a person authorized to accept service. No employee, other than an attorney with the Office of General Counsel, is authorized to accept service of a subpoena on behalf of another employee. The Office of General Counsel may accept service after consultation with the employee named in the subpoena on a case by case basis.

### 3-100.3 STATE’S ATTORNEY’S OFFICE – COURT NOTIFICATION PROGRAM (“eSubpoena”)

Agency personnel needed to testify for the State in a criminal proceeding will receive notice of court dates through the State’s Attorney’s Office’s court notification program, “eSubpoena.” Agency employees are expected to comply with e-Subpoena notifications from the State’s Attorney’s Office as if served with a subpoena.

The program is accessible from the Sheriff’s Office Intranet page, under the Tools heading on the Toolbar. The administrator of the program is a representative of the State’s Attorney’s Office ([adminunit@charlescountymd.gov](mailto:adminunit@charlescountymd.gov)) and is the contact to have passwords reset or for any problems with the system. Questions about court cases should be directed as follows:

- Circuit: Contact the assigned attorney on the case. This can be viewed on the detail link in eSubpoena.
- Juvenile: ([juvenile@charlescountymd.gov](mailto:juvenile@charlescountymd.gov))
- District: ([Dist\\_Ct\\_Group@charlescountymd.gov](mailto:Dist_Ct_Group@charlescountymd.gov))

The eSubpoena Program contains all court cases scheduled for officers in both District Court (jailable traffic and any related charges, criminal cases) and Circuit Court. The officer will be able to view all pertinent information for each of his cases, including the subpoena for the case. The program does not include information for subpoenas issued from defense attorneys or attorneys in civil lawsuits.

Officers should receive notifications of new subpoenas awaiting their acceptance and updates on cases by way of email. Officers are directed to check their email each work day for any new subpoenas or status updates such as the case being canceled or called off. Officers shall also log into the eSubpoena system weekly to ensure they are

**Administrative and Operational Manual****September 12, 2022**

aware of any outstanding subpoenas and status updates. The attorney assigned to the case may also be in contact with the officer directly via email. Officers need to appear in court unless they have been called off or canceled. The State's Attorney's Office no longer utilizes the "on call" feature.

Supervisors will have the ability to check their subordinates' court cases and determine whether they have opened / viewed their subpoenas and on what date. They can also view the status of each case as well as the subpoenas for the case. Supervisors and commanders should log into the eSubpoena system periodically to ensure their staff is keeping current with accepting any outstanding subpoenas.

**3-100.4 DISTRICT COURT - PAYABLE TRAFFIC DOCKETS**

Officers will receive notification of all District Court dates from the District Court via the Administrative Associate – Patrol. The District Court notices include criminal cases, "must appear" traffic offenses, and payable traffic offenses. All employees are expected to appear in District Court for payable citations when notified of a date by the Court. Court appearances for criminal and "must appear" traffic offenses are controlled by the State's Attorney's Office's eSubpoena program.

**3-100.5 UNAVAILABILITY FOR COURT; SAO AND DISTRICT COURT NOTIFICATIONS**

When an officer knows in advance he will be unavailable for court due to approved leave, training, or other circumstances, the officer shall submit a Court Notifications Form #528, at least 30 days in advance, to his supervisor. Forms will be reviewed and signed by the officer's supervisor and commander. The commander will ensure the proper notations are made to the State's Attorney's eSubpoena program with the appropriate leave and days the officer will be unavailable. The form will then be forwarded to:

- Administrative Associate – Patrol (all divisions outside of CID);
- CID Administrator (CID).

The coordinator in each division will be responsible for preparing and sending an email to the District court and the State's Attorney's Office. A copy of the email and all forms will be kept on file for a period of three years. Officers should check their calendars routinely to ensure their leave was posted correctly.

The Agency cannot excuse an officer who has received a summons or subpoena from attending court. When an officer receives a summons from the courts (excluding payable traffic court), either prior to or after submitting a Court Notifications Form to the State's Attorney's Office, it is the officer's responsibility to contact the State's Attorney's Office. Payable traffic court cannot be rescheduled.

District Court dates for criminal and traffic proceedings are published for the calendar year in advance. Scheduled leave requests should not interfere with those dates.

When an officer on approved sick and safe leave is unable to appear in response to a State's Attorney notification, he will make a personal notification to the State's Attorney's Office and make note of the date and time and the person to whom the notification was made.

**3-100.6 SUBPOENAS FOR NON-RECORDS MANAGEMENT EMPLOYEES**

An employee who has been served with a subpoena to appear in court should comply with the subpoena except as described below:

- Unavailable on the scheduled hearing date: notify supervisor and the Office of General Counsel.
- The subpoena seeks productions of records not under the employee's control: forward the subpoena to Records Management with a copy to the Office of General Counsel.



Administrative and Operational Manual

September 12, 2022

- Disclosure of records would be contrary to the Agency's interests (for example, disclosure of information about a confidential informant): notify the Office of General Counsel.
- Employees need to appear in court unless they have been called off or canceled by the party who issued the subpoena.

### 3-100.7 SUBPOENAS – RECORDS MANAGEMENT

Records Management has the primary responsibility to respond to subpoenas duces tecum. Unless directed otherwise by the Office of General Counsel, records disclosed pursuant to a subpoena will be redacted in the same manner as records requests received under the Maryland Public Information Act.

#### ***Criminal Cases***

Upon receipt of a subpoena for a criminal case, Records Management will forward a copy of the subpoena to the State's Attorney's Office. District Court subpoenas are to be forwarded to the State's Attorney's Office District Court coordinator. Circuit Court subpoenas are to be forwarded to the State's Attorney's Office Circuit Court coordinator. Records Management will inform the State's Attorney's Office that the Sheriff's Office intends to comply with the subpoena unless asked to do otherwise within a period not to exceed 3 days.

- If there is no response from the State's Attorney's Office: Records Management will comply with the subpoena and send a copy of records disclosed to the State's Attorney's Office.
- If the State's Attorney's Office has already provided the requested records: Records Management will contact the attorney who issued the subpoena to determine if the material is still being requested from the Sheriff's Office.
- If the State's Attorney's Office will file a motion to quash the subpoena: Records Management will notify the Office of General Counsel. Records Management will not comply with the subpoena until directed to do so by the Office of General Counsel.

#### ***Civil Cases***

Upon receipt of a subpoena for a civil case, Records Management will determine if the subpoena requests records relating to an open investigation. If the records relate to an open investigation, Records Management will contact the investigating officer. If the investigating officer believes disclosure will interfere in the investigation, Records Management will contact the Office of General Counsel.

### 3-100.8 SUBPOENAS – DETENTION CENTER

The Custodian of Records for the Detention Center has primary responsibility to respond to subpoenas duces tecum for Detention Center records.

Upon receipt of a subpoena, the Custodian will assemble the records sought. The Custodian will forward the records and the subpoena to the Office of General Counsel. The Office of General Counsel will review the material prior to providing it to the requesting party. In criminal cases, the Office of General Counsel will send a copy of the subpoena and records to the State's Attorney's Office unless the request is for an inmate's medical records or other records protected by privilege.

If the subpoena requests records relating to an inmate other than the defendant, the Custodian will forward the subpoena to the Office of General Counsel prior to assembling the requested records. The Office of General Counsel may contact the attorney for the affected inmate. The Office of General Counsel will then advise the Custodian as to the appropriate response to the subpoena.



Administrative and Operational Manual

September 12, 2022

### **3-101 ATTENDING COURT**

Upon arriving for a court appearance, regardless of duty status, employees will swipe their key card against the log-in panel located near the security desk of the courthouse they are attending. This action verifies the employee's attendance for the case(s) they are appearing for. Employees will also swipe out at the log-out panel located near the main exit door when the employee leaves the courthouse after being released. If the employee has to return to the courthouse for other cases, the employee will swipe in again to verify their attendance for those cases and swipe out after being released.

Employees will submit and document overtime on their timesheets as required. Audits of this process will be conducted.

### **3-104 EMPLOYEES AS LITIGANTS - PROHIBITIONS**

Employees, while appearing in any court for a personal case not related to official Agency business, shall not wear the Agency uniform or other items of identification which make it apparent they are employees of the Charles County Sheriff's Office. Examples of such cases include:

- Defendant in a criminal proceeding;
- Litigant in a civil proceeding;
- Party to an action;
- Witness in a case not related to official duties;
- Juror.

In all the above cases, with the exception of jury duty, the employee's personally earned and accrued leave must be used to cover work time which the employee misses. Sick and safe leave will not be granted in these cases except as provided in AOM 3-609. As stated elsewhere in policy, employees who serve on jury duty will be permitted to be absent from their duties, as needed, without loss of pay or a charge against any leave.

### **3-105 OFFICERS AS WITNESSES**

An officer summoned or requested to testify on behalf of a defendant in a criminal case shall, as soon as possible after having been summoned or requested, notify the appropriate prosecutor prior to the trial

**Administrative and Operational Manual****September 12, 2022****3-106 AGENCY MAIL HANDLING**

It is the responsibility of the commander, director, or manager of each Agency component to ensure that mail, to and from the component, is expeditiously handled. This means that components which work a 24 / 7 schedule will move mail at least once in each period of the day (evenings, nights, and days); and all other components will move mail at least once for each day of the week for which any of the component's personnel work.

To facilitate this process, the Headquarters Mail Room is the focal point for all pick-up and deliveries. Mail will be dropped-off and picked-up at the Headquarters Mail Room as required by the previous paragraph, and as amplified by the following paragraph.

Mail for delivery by the US Postal Service will be processed through the La Plata Post Office (Zip Code 20646). Transport of US Mail between the La Plata Post Office and Headquarters will be the responsibility of the Commander, Corrections Division, who shall utilize Corrections Transport Officers to fulfill this function. US Mail coming into the Agency will be delivered to the Records Section for sorting and distribution.

**3-106.1 MAIL REQUIRING SIGNATURES**

When there is mail to be picked up at the Post Office which requires a signature, the Corrections Transport Officer will sign for that mail. Any such mail received will be bundled and delivered to the Assistant Sheriff of Operations' Administrative Coordinator. The Administrative Coordinator will see that this mail is delivered through the chain of command to the addressee. Any notice of mail to be signed for at the Post Office will be handled in like manner.

**3-106.2 CADET MAIL DELIVERY**

There are regularly scheduled mail runs which are staffed by Agency cadet personnel. There are occasions and sometimes periods when there are no cadet personnel available to staff these mail runs. When these runs do take place, they relieve the various commanders of the responsibility for mail pick-up and delivery. The schedule for these runs is:

- Monday through Friday:
  - 0900 to 1100, and
  - 1600 to 1800; then
- Saturday and Sunday:
  - 1200 to 1400 hours.

If these mail-runs do not occur during the scheduled hours, the various commanders will ensure the mail is moved as previously required by this policy.

**3-106.3 MAIL NEEDING US POSTAGE**

Whenever mail to be sent via the US Postal Service needs postage applied to the envelope or package, it can be brought to the Records Section Office at Headquarters where postage will be applied. This applies only to official Agency correspondence. Once mail has been weighed and franked, it may be left at Records for delivery to the US Post Office on the next scheduled mail-run, or it may be carried to the Post Office by the Agency person needing the item mailed. Outgoing Mail Codes Form #756 will be attached to all envelopes or packages with the proper Agency account circled.

**3-107 RIDE-ALONG PROGRAM**





Administrative and Operational Manual

September 12, 2022

The ride-along program is designed to provide a vehicle for persons who have an interest in the operations of the Agency, to acquire first-hand knowledge of these operations. The expected benefit is a more knowledgeable community regarding the operations of the Agency, and therefore a community more supportive of the Agency. This program is the responsibility of Patrol operations commanders. The Patrol Commanders will administer the program; however, with approval of other component commanders, a ride-along may take place within any facet of the Agency.

This policy sets forth guidelines regarding the Agency's ride-along program. Specifically, the policy defines that persons who demonstrate a legitimate interest in the operations of the Agency may request permission for a ride-along. Persons who may present a liability to the operations of the Agency may be excluded from participation. Participation is limited, in any event, to a level needed to accomplish the purpose of the program. Generally, several ride-along sessions will suffice. However, the Patrol operations commanders, or other commanders, in the case where the ride-along is to take place within their component, may approve additional ride-along sessions to accomplish a specific purpose or goal. All ride-along participants will be subject to a criminal records check. Ride-alongs are permitted during day and evening shifts only and will not be authorized for the midnight shift.

Employees of the Agency, who are designated by their supervisory authority to ride-along during their work hours for familiarization, and Agency Chaplains are not considered a part of this program. They are not required to complete the ride-along application or waiver. They must, however, complete and have approved the Ride-Along Authorization Form #38.1B. This form provides a means of tracking ride-along activity of all participants. Employees and Chaplains are required to conform to the Guidelines For Ride-Along Participants Form #38.1A during their participation in the program.

Employees of the Agency, the Charles County Government, and Agency Chaplains, who wish, on their own time, to participate in the program, are required to complete the Ride-Along Program Authorization Form #38.1B. These requests will generally be honored unless they become an obstacle to normal operations of the Agency. Due to the Agency Chaplains' duties and responsibilities, requests made on short notice will be accommodated.

Members of the Charles County Sheriff's Explorer's Post #1658 are required to conform to all requirements of the Agency's Explorer Program (see Section 3-107.5). Adherence to this policy is essential for the efficient operation of the Charles County Sheriff's Office, as well as for the protection of Agency members and the community.

**3-107.1 GENERAL**

- Participants must be at least 15 years of age.
- Participants must complete Ride-along applications and Release of Liability Forms, prior to the commencement of any ride-along. Juvenile participants must have a parent or guardian sign these documents.
- Participation may be limited by commanders when they believe such limitation is in the best operational interests of their command.
- Participants will generally be assigned to a one-officer unit and will never accompany a Field Training Officer (FTO) training a recruit officer.
- Participants must be properly attired and observe proper personal hygiene habits.
- All requests must be made at least three days in advance (the affected division commander may waive this requirement at the division commander's discretion).
- All participants shall be subject to a criminal records check.



Administrative and Operational Manual

September 12, 2022

- A supervisor shall instruct the ride-along participants concerning the following:
  - participants must follow directions of the officer they are accompanying; and
  - participants may be required to appear as a witness in a court; and
  - participants may end the ride whenever the participants wish; and
  - a review of the guidelines will be conducted with the ride-along participant and any participant questions answered.

**3-107.1.1 SPECIFIC GUIDELINES**

Persons may request to participate in the ride-along program for a number of reasons and may come from any area of our society. From students completing an educational project, to sworn officers from other agencies considering employment with the Charles County Sheriff's Office, to friends and relatives of current officers and government officials seeking a better understanding of the responsibilities and duties of a police officer, to assessors examining the Agency for compliance with CALEA standards, many individuals have legitimate reason to request a ride-along. It therefore becomes important to differentiate between these persons and what they may and may not participate in to better ensure their safety and the integrity of the Agency's investigations and other activities.

Generally, persons participating in a ride-along who are not employees of this Agency shall not be permitted to enter:

- the private property of any victim, complainant, witness, suspect, or accused;
- the secure areas of any detention facility, to include the Charles County Detention Center;
- the secure areas of any State facility; i.e., Boys' Village at Cheltenham;
- the restricted areas of any facility; i.e., hospital morgues; and
- any other place to which the general public would not otherwise have access.

Officers encountering these situations during a ride-along will deliver the participant to an Agency district station or, if impractical, have the participant remain in the car or an area of public access. An exception may be made for Explorers (in uniform), Criminal Justice Students (in uniform) and Cadets (in uniform) with prior approval from a participant's parent as well as the facility or property owner in question. Officers must consider not all facilities will allow civilian personnel to enter, no matter what their affiliation.

**3-107.2 RIDE-ALONG PROCEDURES**

All ride-along applications are to be submitted to the police station technicians. They will review the application for completeness and conduct a record check of the applicant, to include Local, MILES, and NCIC. A copy of the result of the record check will be attached to the application package, and it will be forwarded to the Administrative Associate – Patrol.

Upon receipt of the application package, the Administrative Associate – Patrol will review the package to determine eligibility. Once the applicant is determined to be eligible to participate, the applicant information will be logged into the database and the package will be forwarded to the appropriate Patrol Division Commander for dissemination to the designated shift commander.

The shift commander will contact the applicant to schedule the ride-along. Once the ride-along is completed, the shift commander shall ensure the comments section of the application is completed and will forward the packet back to the Administrative Associate - Patrol to be filed.

**3-107.3 RESPONSIBILITIES OF THE OFFICER**

The officer directly accompanying the ride-along participant shall:

- refrain from engaging the participant in dangerous situations whenever possible;

**Administrative and Operational Manual****September 12, 2022**

- know and understand the Guidelines for the Ride-Along Participants Form #38.1A;
- return the participant to the point of origin in any incident of objectionable behavior or interference. Should this occur, such action shall be documented by memorandum and forwarded through the chain of command to the employee's division commander, or designee;
- complete, at the end of the program or tour of duty, the Ride-Along Program Authorization Form #38.1B and forward same to the employee's division commander via the commander approving the ride-along.

**3-107.4 EXPLORER'S POST #1658 RIDE-ALONGS**

The Charles County Sheriff's Office is the sponsoring Agency for Explorer Post #1658. As a requirement of the Explorer's advancement in the Post, they must participate in the Agency's ride-along program. While participating in this program, the Explorer is considered an observer and is not given any authority to act as a law enforcement officer. Explorers shall be treated as any other civilian participating in the program.

Training, expected conduct, qualifying requirements, and regulations are detailed in the Explorer Post #1658 SOP Manual.

**3-107.4.1 OFFICER GUIDELINES**

- Supervising officers with whom the Explorer is scheduled to ride should be thoroughly familiar with the objectives of the BSA Law Enforcement Explorer Program generally, the CCSO Ride-Along Program specifically, and willingly accept the Explorer for the ride-along;
- The supervising officer will be approved by the affected Shift/Section Commander, District Supervisor, and the Post Advisor;
- As determined by the Shift/Section Commander, District Supervisor, and Post Advisor, the officer will have no compromising disciplinary action on file;
- The supervising officer will be furnished with a copy of the Ride-Along Program Guidelines;
- The supervising officer will complete an Explorers Evaluation Form #38E after the Explorer's ride-along, which will be forwarded to the Post Advisor through the district supervisor;
- Approval for the supervising officer participation in this program will be at the discretion of the Post Advisor;
- In the event a supervising officer has a problem with an Explorer in the program, the officer will submit a typed letter stating the problem to the Shift/Section Commander, through the chain of command, for relay to the Post Advisor.

**3-107.4.2 HIGH RISK CALL/SITUATIONS**

If, during the course of the ride-along, the supervising officer determines that further participation by the Explorer could or would place the Explorer in a high-risk situation, the supervising officer will disengage the Explorer by one of the below-described methods. Any introduction of an Explorer into an emergency or service call will be consistent with established Agency policy and procedures.

Option A

**Administrative and Operational Manual****September 12, 2022**

- The explorer will remain in the vehicle and observe;
- In the event of an emergency, should the officer be unable to request assistance, the Explorer will transmit a call for back-up or medical assistance;
- The Explorer will remain in the vehicle until the supervising officer has determined the situation is safe and under control. Only upon direct verbal authority from the supervising officer will the Explorer be permitted to exit the vehicle.

**Option B**

Upon receiving a possible high-risk call, the supervising officer will discharge the Explorer from the vehicle at the first safe and secure convenient location and transmit the Explorer's location so that another unit can effect a pick up while the dispatched officer proceeds to the call.

In selecting a suitable locale for discharging the Explorer, the supervising officer will consider the factors of lighting, shelter, safe environment, weather conditions, availability of telephones, and ease of discovery by responding pick up units, in conjunction with the exigencies of the circumstances of the call prompting this action.

**3-108 REVIEW/ RELEASE OF A PERSONNEL FILE**

Employees wishing to inspect their Personnel File must contact the Human Resources Section to make an appointment. Within five working days of receiving the employee's request, the Human Resources Section will schedule an appointment during which the employee can review their file.

All appointments are scheduled during regular business hours. The inspection of the Personnel File will take place in the offices of the Human Resources Section, in the presence of a Human Resources employee.

Employees may make notes, but may not remove or add materials to their Personnel File.

Employees are limited to one review of their Personnel File within a 12-month period. The Commander / Director Administrative Services Division may authorize an exception to this limit upon written request of an employee.

An employee who reviews their Personnel File shall sign the Personnel File Log Book, which is maintained in the offices of the Human Resources Section. The employee shall also sign the Internal Personnel File Log Sheet, which remains a permanent part of the Personnel File.

**3-108.1 REVIEW BY SUPERVISORY AUTHORITY**

As allowed by Maryland Law (Md. General Provisions Code Ann. §4-311), officials who supervise the work of an employee may inspect the Personnel File of that employee. Supervisory personnel may review files for such purposes as:

- familiarization by new supervisors with those employees within his responsibility; and
- employment review for Agency recognition, such as:
  - retirement; and
  - "Officer of the Year" award; and
  - Agency Awards Banquet; and
- Command Staff Review; for promotion/ transfer consideration.

Any commander, manager, supervisor, or other authorized supervisory authority who reviews an employee Personnel File shall sign, date, and indicate the reason for review in the Personnel File Log Book, which is



**Administrative and Operational Manual**

**September 12, 2022**

maintained in the offices of the Human Resources Section. The internal Personnel File Log Sheet will be completed in the same manner and will remain a permanent part of the employee's Personnel File.

**3-108.2 PERSONNEL RECORDS WHICH ARE SUBJECT TO REVIEW**

The following records, which comprise an employee's Personnel File, are subject to review:

- Performance Ratings/ Evaluations;
- Job Descriptions;
- Payroll Change Notices;
- Transfers/ Promotions/ Upgrades;
- Conference Forms/ Disciplinary Actions;
- Commendations/ Awards; and
- Certificates of Training.

**3-109 NOTIFICATION OF EMPLOYEE'S VITAL INFORMATION CHANGE**

Employees must maintain a telephone, either cellular or landline. Telephone, address, and emergency notification information will be maintained by the Information Technology Division.

Employees will submit change of name, address, telephone and emergency notification information to the Human Resources Section within three days of the change. The Human Resources Section will ensure changes are made to the appropriate records and notify the appropriate sections of the Agency.

**3-110 RELEASE OF TELEPHONE OR ADDRESS INFORMATION**

The telephone number or address of a current employee will not be released to anyone who is not employed by the Sheriff's Office. If it appears necessary that the member / employee be contacted immediately, an Agency employee will attempt to telephone that person and request that he call the concerned party. Otherwise, the inquiring party will be advised to either contact the employee during his next tour of duty or leave a message

The Patrol Division Administrator Coordinator will notify the Clerk of Charles County Circuit Court in writing of a sworn employee's departure in order that sworn members may be removed from the rolls of police officers of the County. The notification also allows the Circuit and District Courts, as well as the State's Attorney's Office, to properly address summonses necessary to require the appearance of prior employees.

**3-111 SOLICITATION OF MEMBERS/ EMPLOYEES WHILE WORKING**

Organizations will not be permitted to solicit the support of members / employees of this Agency during their on-duty time. No solicitation or distribution of literature shall be permitted where the orderly operation of the Agency would be impaired.

Individuals may be permitted to solicit support or distribute literature in public areas, such as parking lots and public entrances to buildings, but will not be permitted to interfere with any member / employee who is on duty.

**3-113 FLAG PROTOCOL AND GESTURES OF RESPECT – GENERALLY**

The Charles County Sheriff's Office is a paramilitary organization and as such, it is incumbent upon employees to observe and abide by some basic rules of military protocol. These include, but are not limited to:

- proper display and handling of the various flags utilized by the Agency;
- appropriate gestures of respect during the playing of the National Anthem;
- appropriate conduct during the passage of the U.S. Flag; and



Administrative and Operational Manual

September 12, 2022

- appropriate gestures of respect when reporting to or greeting a uniformed, commissioned officer or member of a formal board.

This section of policy is intended to give guidance to all employees of the Charles County Sheriff's Office in these matters as they pertain to Agency operations.

### 3-113.1 FLAGS

This Agency maintains and displays a number of flags both inside and outside its various facilities. Flags authorized for display, in strict hierarchal order, are:

- Flag of the United States;
- Flag of the State of Maryland;
- Flag of Charles County;
- Flag of the Charles County Sheriff's Office; and
- Flag of The National League of Families POW / MIA.

The Federal Flag Code and Maryland State law require certain protocol be observed when displaying and handling flags. Further, military protocol requires certain conduct when in the presence of the United States flag.

The Commander, Property Management shall designate a person responsible for the flags at Charles County Sheriff's Office Headquarters. District commanders shall designate a person responsible for flags at each district station. For all other Agency facilities, the ranking commander / director assigned to that facility shall designate a responsible person. These persons shall see to it that all flags are displayed in accordance with this policy, to include:

- ensuring all flags being displayed are falling free, not damaged, and do not show excessive wear;
- ensuring flags are never allowed to touch the ground or floor while being displayed, raised, or lowered;
- ensuring all appropriate flags are lowered to half-staff at 0001 hours and raised again at 2400 hours in observance of the following:
  - Peace Officers Memorial Day - May 15<sup>th</sup> of each year, unless it conflicts with Armed Forces Day, in which case it will be observed on May 16<sup>th</sup>;
  - Memorial Day - the last Monday in May of each year, (half-staff until 1200 hours only);
  - National Pearl Harbor Remembrance Day - December 7<sup>th</sup> of each year; and
- any other time in response to official directive:
  - the U.S. flag may be lowered to half-staff by order of the President of the United States only;
  - the Maryland flag may be lowered to half-staff by order of the Governor of Maryland only;
  - the Charles County flag may be lowered to half-staff by order of the Charles County Commissioners only; and
  - the Charles County Sheriff's Office flag may be lowered to half-staff by order of the Sheriff of Charles County only.
- the Commander, Property Management shall be immediately notified whenever an official directive is received, and provided with its details;
- ensuring whenever any flag is flown at half-staff, each subordinate flag is appropriately lowered; i.e., the U.S. flag shall be the first flag raised and the last lowered in any display or ceremony;
- ensuring no flag is displayed in a position of higher honor than the U.S. flag, which is any of the following:



Administrative and Operational Manual

September 12, 2022

- at the center of a group of flags on separate flagstuffs, and the central staff is the highest point;
- at the highest point if on the same flagstaff; or
- on the flagstaff to the observer's extreme left if displayed with other flags on separate flagstuffs of equal height.
- ensuring proper (direct) illumination of flags displayed during hours of darkness; and
- ensuring no other flag displayed is larger than the U.S. flag displayed in the same forum.

The U.S. flag shall always be displayed with the field of union stars in the uppermost left position as viewed by the observer.

The Maryland flag is most easily described as being divided into quadrants with the first and fourth quadrants consisting of alternating gold and black bands, and the second and third quadrants consisting of the cross bottony on fields of red and white. The flag is to be displayed with the black stripe of the first quadrant in the uppermost left position as viewed by the observer, regardless of the method of display (see following illustration).



The Maryland flag shall occupy the position of highest honor subordinate to the U.S. flag, or the flag of another nation if displayed. This would be:

- to the immediate right of the U.S. flag if on flagstuffs of equal height, as viewed by the observer;
- immediately below the U.S. flag if on the same flagstaff; or
- to the extreme left of the U.S. flag if the U.S. flag is displayed at the center point of a group of flags.

If the U.S. and Maryland flags are displayed in the same forum on separate crossed staffs of equal height, the U.S. flag should be on the left as viewed by the observer, and its staff should be in front of the staff of the Maryland flag.

If the U.S. and Maryland flags are displayed on staffs on a speaker's platform or at floor level in a public auditorium, the U.S. flag should be on the speaker's right as the speaker faces the audience, and the Maryland flag should be on the speaker's left. Alternately, both flags can be placed on the speaker's right.

The Charles County flag and the Charles County Sheriff's Office flag shall always be displayed in such a manner as to permit the observer to read the wording on the flag:

- upright if displayed horizontally;



**Administrative and Operational Manual**

**September 12, 2022**

- with the top of the flag to the observer's left if displayed vertically;
- the Charles County Sheriff's Office flag shall be displayed below the Charles County flag if on the same flagstaff; and
- the Charles County Sheriff's Office flag shall be displayed to the right of the Charles County flag as viewed by the observer, if on separate flagstaffs.

It shall be the prerogative of the Sheriff of Charles County to present to any person he deems appropriate, a replica of the Charles County Sheriff's Office flag. The replica may be of any size, style, or material as determined by the Sheriff.

The Charles County Sheriff's Office flag and its design are the property of the Charles County Sheriff's Office, and may not be duplicated, displayed, bartered, traded, or sold without the permission of the Sheriff or his designee.

The finials or ornaments to be displayed at the top of flagstaffs shall be:

- U.S. flag - Eagle;
- Maryland flag - Gold Cross Bottony, (see illustration);
- Charles County flag - Ball on affixed flagstaffs, and Fancy Spear Point on movable or room flagstaffs; and
- Charles County Sheriff's Office flag - Ball on affixed flagstaffs, and Round Spear Point on movable or room flagstaffs.

### **3-113.1.1 POW / MIA FLAG**

The National League of Families POW / MIA flag shall be flown every day of the year in memory of all prisoners of war and Americans missing in action. It shall be smaller than the U.S. flag as dictated by U.S. Flag protocol.

When flying the U.S. flag, the National League of Families POW / MIA flag, and the State flag from two poles, the POW / MIA flag should be flown from the same pole as the U.S. flag, beneath the U.S. flag, with the State flag flying from the pole to the left.

### **3-113.2 GESTURES OF RESPECT**

When in uniform, officers will salute uniformed commissioned officers, who will return the salute. Indoors, only the Sheriff or the Chairman of a formal board (e.g., Hearing Board or Promotion Interview Board) will be saluted.

When reporting to a formal board in uniform, an officer will face and salute the highest ranking member of the board. If the officer is wearing a hat, the officer will remove it prior to being seated.

When the National Anthem is being played or sung, uniformed officers will stand at attention facing the flag and salute if wearing the hat. If the hat is not being worn, uniformed officers and employees in civilian attire will stand at attention facing the flag, and place their right hands over their hearts. If no flag is displayed, all employees will face toward the music and follow the same procedures as if the flag were present.

When the U.S. flag passes by, uniformed officers wearing hats will stand at attention facing the flag and salute until it passes. If the hat is not being worn, uniformed officers and employees in civilian attire will stand at attention, facing the flag with their right hands over their hearts until it passes.

Officers of this Agency are often called upon to assist with traffic direction at intersections for funeral processions. This is the final service police officers can perform for that person. Additionally, it may be the only opportunity the deceased's family has to form an impression of the Agency and its members.

As a gesture of respect to the deceased and support for the family, officers will stand at a funeral procession traffic post, coming to the position of attention and saluting as the hearse and car(s) of the immediate family pass the officer's position.



**Administrative and Operational Manual****September 12, 2022**

Officers must continually be aware, however, of all traffic movement occurring during a funeral procession, and take appropriate action to ensure both the officer's safety and that of the public.

**3-114 EMPLOYMENT TERMINATION**

All employees who terminate, or are involuntarily terminated from their position with the Sheriff's Office, will comply with the following employment clearance procedures. The procedures are designed to provide for an orderly departure and to ensure that uniforms, equipment, vehicles, supplies, money, and obligations owed to the Sheriff's Office, or other government entities, are paid and/or fulfilled. The procedures are also designed to provide that the employee will receive all compensation, benefits, or other obligations owed to the employee by the Sheriff's Office or other government entities. It is in the best interests of all concerned to ensure that it is carried to a complete and correct conclusion. Nothing in this procedure will preclude the Sheriff's Office from instituting criminal and/or civil action as may be indicated by the circumstances of a particular employee's actions or activities.

**3-114.1 EMPLOYEE RESIGNATION**

Employees who wish to resign their position with the Sheriff's Office shall submit a letter of resignation to the Sheriff through their chain of command. The letter will contain the date the employee plans to leave and will be submitted at least two weeks in advance of that date. Upon the acceptance of this letter by the Sheriff, a copy will be sent to Human Resources by the Sheriff's Executive Office Administrator.

With proper advanced notice, the departure of the employee can be handled in an efficient manner to the benefit of the employee and the Sheriff's Office. If circumstances require, the employee may request, or the Sheriff may require, that all or part of the two week period be waived.

Employees who return to employment with the Agency within three (3) years of their resignation will be issued the same employee identification number, if they return to the same Agency segment. If the employee returns to a different segment of the Agency, they will be issued a new employee identification number.

Employees shall not be absent from their place of employment nor abandon their duties without leave to do so. Any employee who does so will be considered to have abandoned his employment with the Office of the Sheriff, Charles County, Maryland.

Failure of the employee to comply with this section will result in a notation of these circumstances in the employee's personnel file.

**3-114.2 RETIREMENT PROCEDURES**

Eligible employees who wish to retire must notify the Sheriff in writing through their chain of command at least thirty (30) days in advance of their intended retirement date.

Sworn and Correctional officers should notify the Sheriff through their chain of command at least sixty (60) days in advance of their intended retirement date. This will allow for the ordering of the personalized retirement badge and other administrative functions such as notification to the courts, State's Attorney's Office, applications for handgun permits, etc.

Upon receipt of the retirement notification, the Sheriff's Executive Office Administrator will forward the original to Human Resources for filing in employee's personnel file.

Human Resources will forward an Agency official notification of this personnel action to:

- the County Government Benefits Administrator;
- the County Government Payroll Manager;
- Accounting Section - Charles County Sheriff's Office;



## Administrative and Operational Manual

September 12, 2022

- the Agency Quartermaster - Charles County Sheriff's Office (ordering of retirement badge);
- the Clerk of Circuit Court (sworn);
- the Clerk of District Court (sworn);
- the State's Attorney's Office (sworn);
- the Assistant Sheriffs; and
- the Employee's division commander.

### 3-114.3 NOTICE OF INVOLUNTARY TERMINATION OF EMPLOYMENT

Whenever an employee is involuntarily separated from employment with the Agency, Human Resources shall provide the employee with documentation outlining the action. The documentation will contain the following information:

- the reason for the termination of employment;
- the effective date of the termination of employment;
- a point of contact within the Accounting Section for receiving information about obtaining a final payroll check distribution;
- a point of contact within the County Government Office of Personnel for obtaining information about the status of any fringe or retirement benefits available after the termination of employment.

### 3-114.4 EMPLOYMENT CLEARANCE FORM

When an employee leaves the Agency they are required to make arrangements to return all Agency owned/issued property and equipment. This will be accomplished by utilizing the Employment Clearance Form #240, which may be obtained under the forms section on the intranet or by contacting the Human Resources Section. Supervisors must provide each employee ample time to return all equipment and complete Form #240.

All Agency owned/issued property and equipment will be returned to the section/division in which it was obtained. When returning these items, the employee will provide the Employment Clearance Form #240 to an authorized representative of each required section/division listed on the form to be signed and to list any property which was not returned and its value.

In the event some obligation is not satisfied, the obligation shall be noted on the form. If value cannot be determined, leave that area blank and return the signed form to the employee. In no instance will the form be held hostage until all obligations are discharged.

**Division / Section** - The section or division commander shall review the provision of this section (Chapter 3, Section 114) with the employee and the contents of the Form #240.

If any special property or equipment is issued at the section or division level, that property shall be recovered by the section / division commander. If any property is not recovered, it shall be listed in the space provided. The total cost of the unrecovered item(s) (the price the Agency originally paid for the item(s)) shall be listed in the space provided.

The employee's division commander shall sign the form (if the employee works in the Office of the Sheriff, an Assistant Sheriff will sign in the division commander space).

**Employee's Division Commander** - The employee's division commander shall recover any special uniform(s), equipment item(s) or weapon(s) issued outside the Quartermaster issue system, except those issued by the Chief Firearms Instructor. The property would have been issued as a result of the employee's participation in some special Patrol Operations Function. Item(s) issued through the Chief Firearms Instructor are not included in this



## Administrative and Operational Manual

September 12, 2022

section of the form since there is a section specifically for the Chief Firearms Instructor. The employee's division commander shall sign the form.

**Information Technology Division** – All Agency-owned electronic or related equipment issued to the employee will be returned to this division. The IT Division Commander shall sign the Employment Clearance Form #240.

**Chief Firearms Instructor** - The Chief Firearms Instructor shall recover any special weapons or associated ammunition and equipment which were issued to an employee through the Chief Firearms Instructor. The Chief Firearms Instructor shall sign the form.

**NOTE:** Any weapon or special equipment not issued by the Quartermaster may be recovered by the Quartermaster if the responsibility for that item has, subsequent to the issue of the weapon or special equipment, been transferred to the Quartermaster. In these cases, the Quartermaster shall notify the issuing authority in order that the issuing authority's records may be cleared. Any adjustments necessary to notations previously made on the Employment Clearance Form #240 shall be initialed (initials and ID number) by the Quartermaster and the issuing authority.

**Quartermaster** - The Quartermaster shall retrieve all uniforms and other items the employee signed for on the Sheriff's Equipment Agreement Form #241. In addition, the Quartermaster shall retrieve any items which may have been issued by another Agency entity, but have since been assigned to the Quartermaster's responsibilities. The Quartermaster shall sign the Employment Clearance Form #240.

**Fleet Services** – Agency-owned vehicle and related equipment will be returned to this function. The Commander, Property Management Section shall sign the Employment Clearance Form #240.

**Communications Section** – Agency-owned radio and related equipment will be returned to this section. The Commander, Communications Section shall sign the Employment Clearance Form #240.

**Accounting Section** – If a Vehicle Certification form and/or Tuition Funding Obligations need to be reconciled, they will be done by contacting the Accounting Section. Employees should refer to AOM 3-620.6 "Service Commitment" regarding tuition funding reimbursement obligations to the Agency for further details. The Deputy Director, Accounting Section shall sign the Employment Clearance Form #240.

**Human Resources** - Human Resources shall retrieve the employee's issued identification cards. There shall be generated an Employee Action Notification announcing the end of the employee's employment with the Agency. The employee's personnel file shall be placed with the inactive personnel files of the Agency. The Deputy Director, Human Resources shall sign and date the Form #240.

When the Employment Clearance Form #240 has been completed through the Employee Certification section, the employee will deliver the form to the Commander / Director, Administrative Services Division. If all obligations of the employee have been satisfied, the Commander / Director shall check the proper boxes in the final section of the form, sign the form and forward it to Human Resources for filing in the employee's personnel file.

### 3-114.4.1 FAILURE TO COMPLETE FORM AND/ OR RETURN AGENCY PROPERTY

In the event that an employee leaves employment without completing the Employment Clearance Form, the Commander/ Director, Administrative Services shall have this segment of the process brought to completion. If upon completion of the Form #240, Agency property is not accounted for, the Commander/ Director will make every effort to contact the employee to reconcile this issue. If the issue cannot be reconciled and the financial obligation is of a significant amount to warrant Agency action, the Commander/ Director shall forward all pertinent reports and documents to General Counsel.

When further action is warranted by General Counsel, the Commander, Office of Professional Responsibility shall be responsible for the internal investigation. Should criminal charges be necessary, the Commander, Office of Professional Responsibility shall cause such charges to be brought by the Internal Affairs investigator assigned to the case. If civil process is warranted, General Counsel will be responsible for the drafting and filing of the necessary



**Administrative and Operational Manual**

**September 12, 2022**

documents.

The Commander, Office of Professional Responsibility shall be responsible for following the criminal case to completion and shall coordinate the marshaling of witnesses and evidence for trial. General Counsel shall bear this responsibility in the civil case. Internal Affairs shall assist General Counsel with any investigation or coordination of witnesses.

Return of Agency property is not an option. The employee may not choose to keep Agency property by paying for that property. Payment for property is for those cases where the employee's negligence has caused the property to be lost, stolen or destroyed.

**3-114.5 FINANCIAL AGREEMENT**

For clearance procedures to be complete, all uniforms, equipment, identification cards, vehicles, gas cards, keys, and any other property belonging to the Sheriff's Office will have been returned. Any damaged or lost items will have been reported in accordance with Sheriff's Office procedures and paid for, unless payment is not required per direction of the Sheriff. Additionally, any outstanding obligations, such as advanced leave, educational funding obligation, disciplinary fines, training service agreement, and so forth, will be satisfied.

In cases where the employee is not in a position to satisfy a financial obligation, a promissory note option will be made available. In this manner, the financial obligation may be satisfied without initiating civil or criminal action.

**3-114.6 CLERK OF THE COURT NOTIFICATION**

It shall be the responsibility of the Administrative Coordinator, Patrol Division, to advise the Clerk of the Charles County Circuit Court of the departure of sworn police officers and other employees as necessary. The notification will be in writing and will contain the departing employee's full name, ID number, and the last work date of the employee.

For sworn members, this notification is necessary in order that they may be removed from the rolls of police officers of the County. The notification also allows the Circuit and District Courts, as well as the State's Attorney's Office, to properly address summonses necessary to require the appearance of prior employees.

A copy of the notification letter will be placed with other departure documents in the employee's personnel file.

**3-114.7 EXIT INTERVIEWS**

The Commander/ Director, Administrative Services, will be responsible for exit interviews for all departing employees. The employee shall contact Human Resources to schedule the interview. These interviews will be conducted as near to the last day of employment as is practical, in order that the information obtained be as candid as possible. The employee is under no compulsion to provide any particular information, but is required to attend the interview. Exception: no employee who is involuntarily terminated is required to complete this interview.

The purpose of the interview is to obtain the employee's perspective of the organization. The Departing Employee Questionnaire Form #242 is used for this purpose. The employee may consider answers to the questions provided on the form before the actual interview and in fact have the form completed upon arrival at the interview. The interview is still necessary in order that clarification may be sought on items which may be unclear.

The actual interview documents will be kept segregated with other confidential documents within the employee's personnel file. Human Resources will maintain the security of these files.

**3-116 EMPLOYEE ASSISTANCE PROGRAM (EAP)**

The Charles County Government provides an Employee Assistance Program (EAP) that is available to all



**Administrative and Operational Manual**

**September 12, 2022**

employees of the Charles County Sheriff's Office. This program can serve as a valuable resource to employees and their immediate family members.

The EAP functions to help employees and their family members with problems that can affect job performance. Problems such as marital issues, job stress, grief, financial concerns, abuse, depression, and chemical dependency can take their toll and often lead to fatigue, poor health, and impaired job performance. The EAP can assist with individual intervention services, seminars, and workshops.

An EAP professional staff member can be reached by phone 24 hours a day, seven days a week to assist with any needs. Initial assessments are free. If additional services are needed, an appropriate referral will be made. The EAP representative will provide guidance and advice to help arrange for the most cost effective services available.

All records of contacts with the EAP and its representatives are strictly confidential and are filed by a case number rather than by name. Information from these files can only be released with written permission of the employee or family member. The only exception to maintaining confidentiality is if an individual poses a clear and immediate danger to themselves, to others, or if the individual has been requested by the Agency to contact the EAP for an Agency mandated evaluation.

EAP brochures with contact information and an outline of the program are available from either the Sheriff's Office or County's Human Resources offices.

### **3-117 DEATH AND FUNERAL PROCEDURES**

#### **3-117.1 INTRODUCTION TO FUNERAL PROCEDURES**

The purpose of this policy is to guide the Agency through the difficult period of mourning after the loss of a member of the CCSO family. Listed are the honors which will be generally afforded each category of personnel that make up the organization. While not every situation can be accounted for, this policy describes the situations that will most often be faced by the Agency when it comes to honoring the passing of members of the CCSO. The final discretion on the implementation of this policy on any given occasion lies with the Sheriff or his designee.

#### **3-117.2 NOTIFICATION OF DEATH OF A MEMBER OF THE CCSO FAMILY**

With the advent of social media, the number one concern for police agencies in regards to the passing of Agency members and those associated with CCSO is the timely and proper notification of those parties identified by the Agency as needing an official notification. With the ability for news to be spread quickly, both accurately and inaccurately, it is imperative that all members of CCSO follow the listed steps in reference to a death notification:

- Any supervisory member learning of the death or grave injury to a member of the CCSO family shall immediately notify their Section Commander by phone. This verbal communication should include the member or members involved in the incident, their current conditions, and their current physical location. If the member is being transported to a medical facility, that information should be passed on as well. If the member is injured or killed on duty, Communications will be responsible to notify the Communications Section Commander to fulfill this section.
- The Section Commander receiving this notification will be responsible for contacting their Division Commander for pass through of the information in the Chain of Command to the Sheriff. After his Division Commander is notified, the Section Commander will immediately notify the supervising employee of the injured or deceased member if they are not aware or it is not known if they are aware.
- The Division Commander receiving notification shall immediately contact their Assistant Sheriff and provide the known information. The Assistant Sheriff receiving the notification will immediately contact the Sheriff



## Administrative and Operational Manual

September 12, 2022

and Chief of Staff and enact the Crisis Response Team (CRT) Protocol if the passing was an unforeseen emergency situation. The Crisis Response Team is responsible for immediate planning and communications at the Executive Command Staff level during the first 12-24 hours of an unforeseen emergency event.

- The members of the Crisis Response Team will respond to the 3<sup>rd</sup> floor of HQ to provide the Agency logistical and communications support during the initial crisis period. There may be specific cases that members of the Crisis Response Team are unable to respond to due to obligations to the Agency which supersede the CRT; (i.e. CID Commander leading Crime Scene Investigations, SOD Commander leading traffic crash investigation, etc). Those members not present should not be assigned tasks related to the CRT function until they are available and present in the CRT room. The CRT should be separate from the command structure at the scene of the incident. There should be a designated communications officer on scene responsible for the passing of information to the CRT. The on-scene commander should not attempt to manage the tasks that are the responsibility of the CRT from the scene. These must be mutually exclusive tasks that share information one way, from scene to CRT. The on-scene commanders will become part of the planning process once the CRT is disbanded and replaced by the planning committee, or ICS command structure that will follow.
- The CRT will decide on the notification team, which should include a Command Staff member and an Agency Chaplain at the minimum. Information from the officer's Agency honor's information sheet should be used to determine the type of chaplain needed for a particular notification to best serve the needs of the family. The Victim Services Coordinator should also be considered for inclusion into this notification group.
- If the notification team is not practical because of distance, i.e., the emergency notification lives out of state, the CRT will determine the appropriate manner of notification. Significant thought should be given to using a local police agency with capabilities similar to CCSO in regards to victim services, chaplains, and supporting staff. The briefing of any such outside team will need to be significant and an Agency liaison should be assigned to provide immediate direct contact to the notification team, ensuring they have the latest information and all questions are answered.

The CRT, once the notification team has been assembled and is on task, begins the process of notification of personnel essential to the agency in the handling of the events surrounding the passing of the employee. This group will include the Honor Guard Commander, the Media Relations Office, the Agency Facilities Manager, Fleet Manager, and any other personnel that are deemed necessary to accomplish immediate tasks. Those personnel should respond to the CRT HQ to provide valuable insight to the CRT and help prioritize those tasks which have to be accomplished in the first 12-24 hours. Anything outside that time frame should be identified and documented for further action once the CRT is disbanded and replaced by the planning committee.

### 3-117.2.1 MEMBERS OF THE CRISIS RESPONSE TEAM (CRT)

The members of the Crisis Response Team will be:

- The Executive Command Staff, and
- Media Relations Specialist.

### 3-117.2.2 PURPOSE OF THE NOTIFICATION TEAM

The purpose of the initial notification team is to tell the emergency contact designated by the employee about the passing or serious injury of the employee. This should be accomplished in a manner which shows respect for the employee and gives the family the reassurance that the Agency cares for their welfare and well-being in the aftermath of their loss. Items the notification team should cover:

- The condition of the employee. If the employee is alive, they should provide transportation to the medical facility treating the employee. The notification team should reassure the employee's family that everything



## Administrative and Operational Manual

September 12, 2022

is being done to help the employee but should never deceive the person being notified about the condition of the employee. If the employee has passed, that should be conveyed in as sensitive of a manner as possible.

- A description of the police process surrounding the situation which led to the employee being gravely injured or killed. If there is a criminal, traffic, or internal investigation being conducted, an explanation should be given generally about what it entails. The notification team should be careful to avoid timetables or conclusive statements about cause or disposition.
- Provide the family with the Agency documented information related to the employee's wishes and determine the amount of assistance that the family wishes to receive from the Agency in regards to funeral planning. No specifics should be discussed with the family; they should be made aware that the Honor Guard Commander will contact them to discuss specifics of any Agency honors that would be given. There is no pressing reason for honors determination in the CRT timeframe with rare exceptions. The notification team should render all of the emotional support possible to the family during the initial visit.
- Depending on the type of the notification, the notification team may be with the family a significant amount of time during the initial notification. This time should be used for the Agency Chaplain, victim services, and administrators to support the family's emotional needs and facilitate additional notifications if necessary. The notification team should be in regular contact with the CRT to update them on what has been done for documentation purposes.

### 3-117.3 TASKS FOR CRT TO ACCOMPLISH

While there is an in-depth checklist associated with the process of honoring an employee that has passed in an emergency circumstance, it should be the objective of the CRT to accomplish the following in the timeframe in which the CRT exists:

- Notify the family of the employee;
- Provide information to the entire CCSO family concerning the passing or grave injury;
- Monitor social and traditional media for any unauthorized release of information by CCSO employees in contradiction to Agency policy or for public information which may be damaging or detrimental to Agency members or the public;
- Issue an initial public statement / media release concerning the passing or grave injury;
- Make a decision / notification on the wearing of the mourning band (Guidelines for the wearing of the mourning band in Section 3-553);
- Order flags to half-staff (Guidelines for the lowering of flags in Section 3-113.1);
- Initiate employee support response by grief counselors / chaplains / etc. and designate a time and place for their availability;
- Assign a liaison officer. The notification team should do reconnaissance with the family to determine who they feel closest to within the Agency. That information should be relayed to the CRT to incorporate into the decision making process. Some factors to consider in determining a liaison officer:
  - The employee's relationship with the family of the Agency employee;
  - The employee's experience including time on job, rank, previous critical incident management, etc.;
  - The effect of the incident on the employee;
- Provide for an initial teletype to be sent via NCIC in reference to a line of duty death. The first teletype should include:
  - Name / Rank or Title of deceased;
  - Date / time of death;
  - Circumstances of death (minimal);
  - Time with Agency;
  - Statement of funeral arrangements to follow;
- Determine the type of death and if the death is in the line of duty, immediately begin the HR process for the line of duty death;
- Have the Honor Guard Commander, based on the death determination, brief the CRT on the protocol that has been determined in this policy based on the status of the employee and how they were killed or died;
- Notify the Chairperson for the Planning Committee for the type of Agency death that the situation dictates



## Administrative and Operational Manual

September 12, 2022

and establish the first Committee meeting date, time and location. The Chairperson of the Planning Committee is designated elsewhere in this policy based on the type of death.

Note: The employee requested by the family for the liaison officer position may not be completely capable of handling the intense nature of the assignment, and in those cases another officer more qualified to handle the assignment may be suggested to the family, incorporating the requested officer as part of a liaison team. There is a tremendous amount of responsibility and tact required in the family liaison position as sometimes requests made are either impossible to provide or conflict with another family request. Each of these requests or issues must be handled delicately and in concert with the preparations being made by CCSO. Therefore, a great deal of consideration should be given to this selection. Once a member of the Agency is designated as a family liaison, they shall have no other assigned tasks throughout the funeral process (i.e., a family liaison cannot act as an Honor Guard member the day of the funeral).

### 3-117.4 PLANNING COMMITTEE MAKEUP

The Planning Committee for an Agency related death should encompass all of the persons who will have a command or supervisory responsibility during the execution of a funeral plan with CCSO. The Incident Command Structure, which is the execution group for the Planning Committee, will often mirror this group with the exception of aspects only used the day of the funeral. The Planning Committee's function is to plan the ceremonies and activities associated with the event. From the pre-funeral planning to the wake, all aspects have to be considered and accounted for whenever possible. The size and scope of this committee will change based on the type of death, the employee's position within the Agency, and the relationship of the death to their work assignment.

A line of duty death committee will be a much larger and more encompassing group than a committee for a retired officer's funeral. The listed members of the Planning Committee for each type of funeral only delineate Agency personnel. More often than not, members of allied agencies such as Department of Emergency Services, Charles County Government, etc., may be named as members of the Planning Committee. A Planning Committee should be enacted whenever honors are given by the Agency to an employee / former employee. The Chairperson of the Committee is responsible for setting the meeting schedule for their Committee and for the documentation of the event being completed and submitted to the Planning and Accreditation Section for filing under CALEA requirements.

The Planning Committee for the services surrounding the death of an **Immediate Family Member of a CCSO Employee**:

- Special Operations Division Commander (**Chair**)
- Division Commander of employee affected
- Section Commander of employee affected
- Honor Guard Commander
- Honor Guard Coordinator
- Field Operations Section Commander
- Traffic Operations Supervisor

This Committee may only meet the minimum of one time to ensure all of the action items related to this type of funeral are covered.

The Planning Committee for the services surrounding the death of an **Active Member of a Southern Maryland Law Enforcement Agency or Regional Department Head**:

- Special Operations Division Commander (**Chair**)
- Field Operations Section Commander
- Honor Guard Commander
- Honor Guard Coordinator
- Traffic Operations Supervisor





**Administrative and Operational Manual**

**September 12, 2022**

---

This Committee may only meet the minimum of one time to ensure all of the action items related to this type of funeral are covered.

The Planning Committee for the services surrounding the death in the **Line of Duty of an Outside Law Enforcement Agency**:

- Special Operations Division Commander (**Chair**)
- Field Operations Section Commander
- Honor Guard Commander
- Honor Guard Coordinator
- Traffic Operations Supervisor

This Committee may only meet the minimum of one time to ensure all of the action items related to this type of funeral are covered.

The Planning Committee for the services surrounding the death of an **Active Uniformed Member by Suicide**:

- Chief of Staff / Lieutenant Colonel (**Chair**)
- Assistant Sheriff of Operations
- Assistant Sheriff of Administration
- Administrative Services Division Commander / Director
- Special Operations Division Commander
- Field Operations Section Commander
- Honor Guard Commander
- Honor Guard Coordinator
- Traffic Operations Supervisor
- Commander of the affected employee's Division
- Commander of the affected employee's Section
- Media Relations Representative

The Committee will be responsible for providing Honor Services to the employee in a manner which shows respect for their time of service and empathy for the manner in which they departed. There is a stigma that is associated with suicide which often causes police agencies to wrongfully neglect the family of a uniformed employee who has committed suicide but served the Agency and community honorably. CCSO will thereby provide honors which demonstrate compassion and appreciation for the employee commensurate with their service to the Agency.

The Planning Committee for the services surrounding the **Death of an Active / Retired Member in Questionable or Poor Standing**:

- Assistant Sheriff of Administration (**Chair**)
- Assistant Sheriff of Operations (if employee is currently under their command)
- Administrative Services Division Commander / Director
- Special Operations Division Commander
- Field Operations Section Commander
- Honor Guard Commander
- Honor Guard Coordinator
- Traffic Operations Supervisor
- Commander of the affected employee's Division
- Commander of the affected employee's Section

The Chairman will evaluate the personnel file of the employee in question. If the subject is no longer employed by the Agency, the Chairmen, in consultation with the Sheriff, will decide if honors will be given. If an employee was



## Administrative and Operational Manual

September 12, 2022

terminated, no honors are rendered. If an employee was facing termination at the time of his death, the Sheriff shall determine if the findings of the personnel process would coincide with a termination and no honors shall be rendered. If a review of the personnel file shows that the employee left in poor standing but was not terminated, the Sheriff shall determine, based on the employee's contribution to the Agency and the community, whether or not the employee shall have limited honors bestowed. If the employee was under scrutiny at the time of their death, but no absolute determination can be made prior to the employee's burial, the employee shall receive limited honors as determined by the Planning Committee evaluation of the honors available in Section 3-117.5 and under the direction of the Sheriff or his designee. It is recognized that investigations and inquires can often have unexpected outcomes and it is impossible to provide honors to a subject post internment.

The Planning Committee for the services for a **Retired Civilian Member**:

- Assistant Sheriff of Administration (**Chair**)
- Commander of Division employee retired from (last assignment)
- Administrative Services Division Commander / Director
- Special Operations Division Commander
- Field Operations Section Commander
- Honor Guard Commander
- Honor Guard Coordinator
- Traffic Operations Supervisor
- Media Relations Representative

If the Retired Civilian Member is having services outside of Charles County, a two-member honor detail, at minimum, should be sent to represent CCSO. If the services are within a reasonable distance and the Planning Committee chooses, they may elect to send up to the contingent determined for a Retired Civilian Member within Charles County.

The Planning Committee for the services of **Retired Uniformed Member**:

- Assistant Sheriff of Administration (**Chair**)
- Commander of Division employee retired from (last assignment)
- Administrative Services Division Commander / Director
- Special Operations Division Commander
- Field Operations Section Commander
- Honor Guard Commander
- Honor Guard Coordinator
- Traffic Operations Supervisor
- Media Relations Representative

The Planning Committee will provide full services to a Retired Uniformed Member within the State of Maryland, Virginia, Delaware, Pennsylvania and West Virginia, and in the District of Columbia. Outside of that area, the Agency should send at a minimum, a two-member honor detail to represent CCSO at the funeral of a Retired Uniformed Member.

The Planning Committee for the services of an **Active Civilian Member in Good Standing**:

- Chief of Staff / Lieutenant Colonel (**Chair**)
- Assistant Sheriff of the employee's Division
- Commander of the employee's Division
- Commander of the employee's Section
- Administrative Services Division Commander / Director
- Special Operations Division Commander
- Field Operations Section Commander



Administrative and Operational Manual

September 12, 2022

- Honor Guard Commander
- Honor Guard Coordinator
- Traffic Operations Supervisor
- Media Relations Representative

The Planning Committee for the services of an **Active Uniformed Member in Good Standing**:

- Chief of Staff / Lieutenant Colonel (**Chair**)
- Assistant Sheriff of Operations
- Assistant Sheriff of Administration
- Commander of the employee's Division
- Commander of the employee's Section
- Administrative Services Division Commander / Director
- Special Operations Division Commander
- Field Operations Section Commander
- Honor Guard Commander
- Honor Guard Coordinator
- Traffic Operations Supervisor
- Media Relations Representative

The Planning Committee for the services of a **Civilian that is Killed or Dies in the Line of Duty**:

- Chief of Staff / Lieutenant Colonel (**Chair**)
- Assistant Sheriff of Operations
- Assistant Sheriff of Administration
- Commander of the employee's Division
- Commander of the employee's Section
- Administrative Services Division Commander / Director
- Special Operations Division Commander
- Field Operations Section Commander
- Honor Guard Commander
- Honor Guard Coordinator
- Traffic Operations Supervisor
- Media Relations Representative

The Planning Committee for the services for a **Uniformed Officer that is Killed or Dies in the Line of Duty**:

- Chief of Staff / Lieutenant Colonel (Chair)
- Assistant Sheriff of Operations
- Assistant Sheriff of Administration
- Administrative Services Division Commander / Director
- Special Operations Division Commander
- Field Operations Section Commander
- Honor Guard Commander
- Honor Guard Coordinator
- Traffic Operations Supervisor
- Media Relations Representative
- Commander, Support Services
- Commander, Patrol Division
- Executive Command Staff Members not specifically named
- Executive Command Staff of Corrections if the employee is from the Corrections Division

All Planning Committees will be responsible for ensuring the Agency properly shows respect to the family of the



## Administrative and Operational Manual

September 12, 2022

lost member while documenting and monitoring such issues as cost, manpower, and affect to our response capability, etc. The Planning Committee's goal should be to foresee problems and issues and prepare for them so that on the day of the funeral such issues are minimized, mitigated, or avoided all together.

### 3-117.5 HONORS GUIDELINES FOR EACH TYPE OF AGENCY FUNERAL

Below, listed in the same order as the planning committees, is stated the type of honors that CCSO will provide to each type of Agency related funeral. The honors provided in each group type demonstrate a deep regard to each employee's / retiree's contributions and the Agency's desire to show respect and appreciation for their family. They keep in the best traditions of police agencies from all over the country.

- **Death of a Member of CCSO Uniformed Officer's Immediate Family**
  - Casket Team
  - Honor Platoon
  - Procession Support
  
- **Death of Active Member of Southern Maryland Law Enforcement Agency or Regional Department Head**
  - Color Team
  - Honor Platoon
  - Procession Support
  
- **Death in the Line of Duty of a Member of Another Law Enforcement Agency**
  - Color Team
  - Honor Platoon
  - Procession Support
  
- **Death of an Active Uniformed Member by Suicide**
  - Taps
  - 3 Volley Salute
  - Casket Team
  - Color Team
  - Flag Fold
  - Agency Flag Presentation
  - Honor Platoon
  - Traffic Support
  
- **Death of an Active Member / Retired Member in Questionable / Poor Standing**
  - Casket Team
  - Flag Fold
  - Traffic Support
  
- **Death of a Retired Civilian Member**
  - Casket Team
  - Flag Fold (if flag draped)
  - Agency Flag Presentation
  - Honor Platoon
  - Procession
  
- **Death of a Retired Uniformed Member**
  - Taps
  - 3 Volley Salute
  - Casket Team



Administrative and Operational Manual

September 12, 2022

- 
- Color Team
  - Modified Death Watch
  - Flag Fold
  - Agency Flag Presentation
  - Honor Platoon
  - Procession
  
  - **Death of an Active Civilian Member in Good Standing**
    - Casket Team
    - Color Team (if flag draped)
    - Flag Fold (if flag draped)
    - Modified Death Watch
    - Agency Flag
    - Honor Platoon
    - Procession
  
  - **Death of an Active Uniformed Member in Good Standing**
    - Taps
    - 3 Volley Salute
    - Bagpipes
    - Casket Team
    - Color Team
    - Last Call
    - Modified Death Watch
    - Flag Fold
    - Agency Flag Presentation
    - Honor Platoon
    - Procession
  
  - **Death in the Line of Duty of a Civilian Member**
    - Casket Team
    - Color Team
    - Full Death Watch
    - Flag Fold
    - Agency Flag Presentation
    - Bunting
    - Honor Platoon
    - Procession
  
  - **Death in the Line of Duty of Uniformed Member**
    - Taps
    - 21 Round Volley Salute
    - Bagpipes
    - Memorial Car
    - Bunting
    - Casket Team
    - Color Team
    - Last Call
    - Full Death Watch
    - Flag Fold
    - Agency Flag Presentation
    - Caisson
    - Outside Agency Participation request
    - Flyover
    - Honor Platoon



## Administrative and Operational Manual

September 12, 2022

- Procession

Detailed definitions explaining each one of the listed honors is available in the Honor Guard SOP in the Special Operations Division.

The responsibility for the production of each of these honors is listed as follows:

## Honor Guard Commander

- Taps
- 3 Volley Salute
- Bagpipes
- Casket Team
- Color Team
- Death Watch
- Flag Fold
- Agency Flag Presentation
- Honor Platoon

## Field Operations Section Commander

- Procession
- Flyover
- Caisson

## Commander of Officer's Section

- Memorial Car

## Communications Section Commander

- Last Call
- Outside Agency Participation request

## Facility Commanders

- Bunting

### 3-117.6 PLANNING COMMITTEE TASKS

The Planning Committee will be responsible for all aspects of the planning and preparation for an Agency funeral up to the day of the event(s). On that day, the Planning Committee shall turn over the event to the Incident Command Structure developed for the events surrounding the funeral. This Committee, and the corresponding ICS, can include members from outside the agency who are responsible for the monitoring or management of tasks during a funeral event. A complete checklist of tasks is included in the reporting section of the manual for each area of responsibility, but in general, shall include the following:

- Review Member's Honors Information Sheet
  - Determine wishes of member from previously submitted sheet
  - Provide that information to the family
  - Determine based on family / officer wishes, what honors and services are needed
- Benefits
  - Based on type of death, begin Human Resources processes related to the member
  - Apply for local, state, and federal benefits as they apply to the loss of member
  - Coordinate non-governmental benefits (i.e. C.O.P.S. and FOP) with family
- Communications
  - Send second nationwide teletype with complete death / funeral arrangement information
  - Send email communications to the following groups in reference to arrangements, as applicable:



Administrative and Operational Manual

September 12, 2022

- COG
  - Honor Guards
  - Motorcycle Units
  - K-9 Units
  - Fire / EMS associations
- 
- Family / Member's Personal Needs
    - Liaison Communications
    - Family Needs and Support
    - Transportation
  
  - Funeral Preparations
    - Honors determined – Honor Guard process detailed in Honor Guard SOP
    - Communications with religious officiate and locations of services for site plan and service order
    - Uniform retrieval and preparation, if applicable
    - Obituary assistance to family
    - Provide for policing coverage within the county if appropriate
  
  - Property / Quartermaster
    - Retrieval and inventory of all Agency property and vehicles
    - Process and submit all personal property to Property Held to be released to the Estate (no personal property should be returned to the family)
    - Prepare Memorial Car when applicable
  
  - Media Communications
    - Provide updated information on incident when applicable
    - Inform affected citizens about services and the implications on traffic, etc.
    - Determine with family how much media access, if any, will occur at services
    - Provide photographic and video services to memorialize the event for the Agency when applicable
  
  - Repass / Food
    - Determine how much, if any, Agency involvement will occur during the repass
    - Provide food for Honor Guard when possible and necessary during prolonged events such as the viewing and funeral
    - Assist in organizing and providing food to the family during the days after the loss of the employee when applicable
  
  - Outside Agency Liaison
    - Maintain roster of all departments who send condolences, plan on attending, or wish to participate in some fashion
    - Forward those wishing to participate to the proper Agency coordinator (honor guards to Honor Guard Coordinator, motorcycles to Traffic Operations, etc.)
    - Arrange for police coverage during funerals requiring all members be available to attend
  
  - Medical
    - Provide medical standby services throughout all of the scheduled events
    - Provide for the rehabilitation / maintenance of participating members physical / medical needs during events
  
  - Work Coverage
    - Reach out to neighboring agencies for backfilling of positions within CCSO to ensure adequate police services are rendered during a funeral event
  
  - Security for Event
    - Bomb Detection



## Administrative and Operational Manual

September 12, 2022

- 1<sup>st</sup> Amendment Preparation
- Executive Protection Coordination
  - Provide for identification, arrangements once on scene
  - List who is coming to which events

### 3-117.7 MEMORIAL CAR

The Memorial Car is an honor to be extended only to an officer who is killed or dies in the line of duty.

The Commander, Property Management will arrange for a marked cruiser to be used as a Memorial Car. It will be clean with no extra equipment in its interior. The Memorial Car shall have its light bar draped with black bunting and one stripe of black tape will be placed horizontally through each door shield at the center of the star. The Sheriff's decal on the cruiser's trunk shall have one stripe of black tape running horizontally through the center of each decal. The Memorial Car shall have the officer's ID number placed on each side and rear of the vehicle. The Memorial Car will be assigned to a member of the officer's squad / unit and will be the responsibility of the squad throughout the events leading up to and including the funeral.

### 3-117.8 DEATH BUNTING FOR CCSO FACILITY BUILDINGS

Death bunting will be draped on the front of the Headquarters building and all district stations. This may be obtained through local fire departments or neighboring law enforcement agencies. It shall be the responsibility of each facility commander to arrange for death bunting on their facility. The following facilities shall have death bunting displayed:

- CCSO Headquarters
- CCDC
- CCDC Annex
- CCSO Annex on Audie Lane
- District One
- District Two
- District Three

### 3-117.9 MOURNING BANDS

Mourning Bands will be worn as prescribed in Section 3-553 of the uniform policy. Mourning bands will be worn during the time periods delineated in that section unless the Sheriff or his designee alters the timeframes. Orders surrounding mourning bands will be communicated via the Planning Committee to the Agency.

### 3-120 FUNERALS FOR MEMBERS OF OTHER LAW ENFORCEMENT AGENCIES

In the event of the death of a member of another law enforcement agency within our region who has been killed in the line of duty or who died from injuries / wounds sustained in the line of duty, the extent of the Agency's participation shall be:

- The Honor Guard will participate in the services to the extent requested by the agency of loss and in accordance with this policy.

**NOTE:** For the purpose of this policy, our region consists of Charles, Prince George's, St. Mary's, Calvert, and Anne Arundel counties in Maryland; King George and Westmoreland counties in Virginia; any Maryland State Law Enforcement agency, which includes all Sheriff's offices; and any Law Enforcement agency in Washington, D.C.

### 3-121 REQUEST TO SERVE AS A PALLBEARER IN UNIFORM FOR SOMEONE





Administrative and Operational Manual

September 12, 2022

## OUTSIDE THE AGENCY

If a sworn member of this Office is asked to serve as a pallbearer in uniform for someone outside the Agency, the request shall be submitted in writing to the Sheriff. The Sheriff or his designee will approve or deny that request at their discretion.

### 3-122 PROCEDURAL VARIATION

The procedures outlined in this policy shall be followed in most cases. Any changes made necessary by shortage of manpower, the unusual size of the funeral, the type of service, the physical arrangement of the place of service or any other reason shall be made by the Sheriff or his designee.

Any additional honors to be accorded to the deceased employees of this organization or other law enforcement agencies shall be at the discretion of the Sheriff.

### 3-123 AGENCY SENTIMENTS OF SYMPATHY

It is appropriate that the Agency express sentiments of sympathy on the occasion of a personal loss experienced by one of its employees. A simple thoughtful act can be a great comfort and provide encouragement at a time when the employee has an emotional need for such encouragement. This Agency expects loyalty and great efforts from its employees in the performance of their tasks. Similarly, the Agency must support the employee when the occasion presents itself.

To this end, all supervisors, managers, commanders and directors are charged to be continually aware of the needs of their subordinates. Such knowledge comes from the efforts expended in getting to know the employee as a person, as well as a worker. Additionally, it should be understood by all employees they are expected to relay knowledge of the needs of fellow employees to supervisory personnel.

Whenever and by whatever means such knowledge comes to the attention of a director or commander, the director or commander shall contact the Assistant Sheriff of Operations, relaying information concerning an employee. If it is appropriate under this policy, the Assistant Sheriff shall cause to be sent in the name of the Agency and its employees, a gift of flowers, a plant, or a fruit basket. A note of expression of sympathy and/or support shall be created as appropriate.

#### 3-123.1 SOURCE OF FUNDING

Revenues generated within the Charles County Sheriff's Office from the sales of various vending machines have been designated to be used for the benefit of employees.

All vending machines and vending operations located within Agency facilities or on Agency property will receive the approval of the Assistant Sheriff of Operations or his designee prior to installation.

#### 3-123.2 LEVELS OF EXPENDITURES AND DELIVERIES

In general, the Assistant Sheriff of Operations will ensure that the level of funds expended is uniform from employee to employee. The amount expended for a flower arrangement, plant or fruit basket, including delivery, should not exceed \$75.00 per item. If the delivery is to be made within a reasonable distance and it would be appropriate for an Agency member to personally deliver the item, the saved delivery fee can become part of the item expense. It is generally more desirable to deliver an item in person and this responsibility should be accepted by the employee's supervisor or commander. If the affected employee has a close personal friend who is an employee, it may be more appropriate for that employee to deliver the item, at the commander's discretion.

**Administrative and Operational Manual****September 12, 2022****3-123.3 APPLICABILITY**

This policy is applicable to all cases where an employee experiences the death of a spouse, parent, child, stepchild, brother, sister, or grandparent. It also applies to grave illness or injury to the employee and hospitalization of the employee. The policy may be extended to other circumstances at the discretion of the Sheriff or Assistant Sheriff of Operations.

**3-123.4 RECORD KEEPING**

The Assistant Sheriff of Operations shall cause a record to be made of each item purchased under this policy. That record shall include:

- the nature of the item purchased;
- the date of the purchase;
- the vendor from whom item was purchased;
- the amount of the expenditure;
- the name of the employee and, if a relative of the employee was the reason for the purchase, the name of the relative;
- the date and place the item was delivered; and
- the method of delivery, or in the case the item was delivered by an employee, the name of the employee.

In addition, the Assistant Sheriff shall cause to be written a brief description of the circumstances surrounding each event.

In January of each year, the Assistant Sheriff of Operations shall cause to be made a summary of the expenses of this program, including the number of events experienced. To the extent possible, an estimate of the needs for the upcoming calendar year's known events will be developed and presented.

**3-123.5 INTERAGENCY ANNOUNCEMENT OF DEATHS - AGENCY PERSONNEL FAMILY MEMBERS, PROMINENT CITIZENS, AND PUBLIC OFFICIALS**

The death of Agency personnel family members, prominent citizens, or public officials shall require certain notifications be made. In this regard, the following requirements will be met:

- Any time an employee learns of a death meeting the above criteria, that information shall be immediately relayed to the employee's Division Commander. The Division Commander, or the commander's designee, will then provide that information to the Chief of Staff through the Chain of Command. This information will be distributed by the most effective means, to include the use of telephone or cell phone contact, if other methods do not allow for timely notification.
- If funeral arrangements are not initially provided, the information, when obtained, will be forwarded to the Office of the Sheriff personnel.
- Agency-wide official notification will then be prepared and distributed by the Office of the Sheriff, under the Sheriff's signature, announcing the arrangements.
- In all cases where there is less than two days' notice prior to the first viewing, telephone notifications will be made, as soon as practical, to the Sheriff and the Chief of Staff by the commander or a designee.



Administrative and Operational Manual

September 12, 2022

### 3-130 CRIMINAL JUSTICE AND SOCIAL SERVICE DIVERSION PROGRAMS

The Charles County Sheriff's Office recognizes there are criminal justice and social service diversion programs available which are sometimes better suited to handle distinct cases. Such cases may involve:

- alcohol and drug abuse problems;
- mental illness; and
- non-violent juvenile offenders.

It shall be the policy of the Charles County Sheriff's Office to cooperate, when appropriate, with criminal justice and social service diversion programs. In making the decision as to whether to use diversion programs, officers will rely on their training, experience, and the guidelines in the AOM. Examples of typical cases officers may be involved in include, but are not limited to:

- issuance of alcohol and juvenile citations;
- emergency psychiatric evaluations;
- referrals to Teen Court via Form #170; and
- referrals to social service agencies.

The Agency's role with regards to referrals to social service agencies is normally limited to non-criminal cases. Charles County social service agencies and some of the services they provide include:

- The County Department of Social Services:
  - family foster care;
  - emergency food resources; and
  - homelessness and emergency housing.
- The County Department of Health:
  - substance abuse treatment and prevention services;
  - assistance for disabled persons; and
  - mental illness.
- The County Department of Community Services:
  - senior care programs;
  - family care giver support;
  - emergency assistance for seniors for food, fuel and prescriptions;
  - meals-on-wheels;
  - legal services; and
  - senior housing options.

Communications shall maintain contact information for the above County departments, and information is also available on the Charles County Government's web page.

### 3-149 REQUESTS FOR LAW ENFORCEMENT ASSISTANCE

The overview of the Memoranda of Understanding, Cooperative Agreements, and Mutual Aid Agreements in the following sections of this Manual outlines procedures for responding to or requesting assistance from other jurisdictions. The guidelines outlined in the various agreements will be followed by members of the Charles County Sheriff's Office. Absent provision in the document, the Sheriff may direct the review of any agreement at his discretion.

**Administrative and Operational Manual****September 12, 2022**

Generally, only supervisory or command officers may authorize a request for, or response to, a request for assistance. Except in emergency situations where there exists the possibility of loss of life or serious injury, this procedure will be followed.

Requests for immediate assistance shall be made through the Communications Section. Unless an emergency, Communications will contact a patrol supervisor for approval before requesting or dispatching assistance. When assistance is requested from another jurisdiction, Communications will stay in continuous telephone contact with the Communications Section of the responding agency as necessary to ensure that needed information is relayed. Upon arrival, outside units should be teamed up with on-scene Agency personnel to aid in communications.

Pre-planned routine requests for assistance shall be forwarded up the chain of command to the Sheriff or his designee for consideration and approval.

### **3-150 MARYLAND STATE POLICE - COOPERATIVE AGREEMENT**

The Charles County Sheriff's Office and the Maryland State Police have signed a Memorandum of Understanding (MOU) to govern the interactions of the two Agencies. The MOU was created in order that the best possible service might be rendered to the citizens of Charles County by both Agencies. This can be done through the cooperative efforts of the two Agencies in coordinating the delivery of services.

This MOU provides that certain responsibilities will be primary for each Agency. The Agency which is not primary will provide supporting services to the other upon request. The MOU also provides for the sharing of information and reporting of activities in a manner which best serves the citizens of the County.

#### **3-150.1 RESPONSIBILITIES OF THE CHARLES COUNTY SHERIFF'S OFFICE**

The Charles County Sheriff's Office will have the primary responsibility for:

- requests for police services;
- all criminal investigations, except where an involved citizen specifically and adamantly requests the Maryland State Police investigate the incident;
- disaster and civil emergency response;
- the Charles County Courthouse;
- the Charles County Detention Center;
- the Charles County Work Release Facilities;
- any joint county / state facilities;
- the handling of a scene of a minor traffic incident occurring on a state or interstate route when the Charles County Officer is on the scene when the crash occurs, or immediately thereafter, unless committed to a higher priority;
- the investigation of traffic crashes involving Charles County owned vehicles, regardless of the location of the crash within Charles County;
- the investigation of all motor vehicle crashes involving County owned and privately owned school buses used for the transportation of students associated with the Charles County Board of Education, private



**Administrative and Operational Manual**

**September 12, 2022**

contractors, and related activities on all roadways in Charles County;

- traffic enforcement, traffic control, traffic crashes, roadway hazards, abandoned vehicles and the like on other than state and interstate highways in Charles County; and
- the investigation of all criminal and administrative incidents involving the use of deadly force or discharge of a weapon by a member of the Charles County Sheriff's Office.

**3-150.2 RESPONSIBILITIES OF THE MARYLAND STATE POLICE**

The Maryland State Police will have primary responsibility for:

- traffic enforcement, traffic control, traffic crashes, roadway hazards, abandoned vehicles and the like on state and interstate highways in Charles County;
- the handling of a scene of a minor traffic incident occurring on a County roadway when the State Police Officer is on the scene when the crash occurs, or immediately thereafter, unless committed to a higher priority;
- law enforcement activities (including criminal investigations) and response to rioting and civil unrest at state owned or operated facilities or institutions;
- the investigation of traffic crashes involving state owned vehicles regardless of the location of the crash within Charles County;
- the investigation of criminal matters when there is a specific request by a public official, law enforcement agency, or an involved citizen;
- the actions necessary to control and handle an in-progress crime when the State Police Officer is on the scene at the time of occurrence (follow-up investigation will be the responsibility of the primary designated agency); and
- the investigation of all criminal and administrative incidents involving the use of deadly force or discharge of a weapon by a member of the Maryland State Police.

In all cases of criminal investigations, with the exception of sensitive, covert, organized crime, criminal conspiracies, and intelligence gathering investigations, the Maryland State Police will consult with the Charles County Sheriff's criminal investigators, as soon as possible, and may, upon agreement of the Charles County Sheriff, relinquish the investigation to the Charles County Sheriff.

**3-150.3 CONCURRENT INVESTIGATIVE RESPONSIBILITIES**

The following criminal violations may be investigated by either Agency:

- Assaults - Other than Aggravated;
- Weapons Violations - Illegal Wear / Carry;
- Handgun Permit Violations;
- Drug Abuse Violations;
- Disorderly Conduct;
- Malicious Destruction of Property (witnessed with apprehension);
- Escapees (MSP to investigate those from state owned facilities only);
- Unauthorized Use of Motor Vehicles;
- Untaxed Cigarette Violations;



**Administrative and Operational Manual**

**September 12, 2022**

- Liquor Law Violations (witnessed violations only);
- Trespassing;
- Vagrancy; and
- Others / Miscellaneous, i.e., Computer / Environmental Crimes.

**3-150.4 MUTUAL ASSISTANCE**

The Charles County Sheriff's Office and the Maryland State Police have agreed to mutually assist each other, limited to the availability of resources of each Agency. Each Agency has also agreed to request the assistance of the other in cases where a timely response cannot be made because of lack of available resources, regardless who has the primary responsibility in the instant case. Coordination of these requests will be made through the dispatching operations of each Agency.

**3-150.5 WARRANT SERVICE**

The Charles County Sheriff's Office is primarily responsible for warrant service in Charles County. The Maryland State Police will handle only those warrants which are relative to State Police investigations or other state enforcement Agency investigations and inter-jurisdictional warrants received by the State Police.

**3-150.6 COOPERATIVE EFFORTS**

It is anticipated that the agreement between the Charles County Sheriff's Office and the Maryland State Police will further the cooperative efforts of both agencies in providing the best possible police services to the citizens of Charles County. All members of this Agency will continue to aid the State Police in all law enforcement activities of mutual concern given the limitations imposed by Agency resources. Members will continue to open channels of communications and set up operational cooperative efforts whenever possible.

**3-150.7 RESOLUTION OF OPERATIONAL QUESTIONS REGARDING MOU**

If a question arises regarding a specific area of responsibility of either Agency, the question should be addressed at the operational level of each Agency. If a resolution of the question cannot be developed at the operational level, the question will be resolved by the management of the Charles County Sheriff's Office and that of the Maryland State Police. A written discussion of the question should be addressed to the Sheriff, by the affected member, and directed through the chain of command. The Sheriff will meet with the Maryland State Police and provide a response to cover the question.

**3-151 MEMORANDUM OF UNDERSTANDING (MOU) - COLONIAL BEACH POLICE DEPARTMENT**

The Charles County Sheriff's Office and the Colonial Beach Police Department have entered into a Memorandum of Understanding concerning police services provided to that area of Charles County, which is immediately adjacent to the Town of Colonial Beach, Virginia. This section outlines the MOU and provides guidance to employees of the CCSO when they are called upon to respond to calls for service in this area.

The original MOU was signed on May 19, 1998. A copy of the MOU is filed in the Office of the Sheriff. The MOU remains in effect until canceled or revised by one of the Chief Executives of either Law Enforcement Agency.

The MOU essentially provides that the Colonial Beach Police may make an initial response to emergency needs for police services in those areas of Charles County adjacent to Colonial Beach. It further provides that the assistance and resources of each Agency may be requested and received, one from the other, at the discretion of the providing Agency. Follow-up investigations remain the responsibility of the Agency which has original jurisdiction.

**Administrative and Operational Manual****September 12, 2022**

“Emergency,” as used in the agreement, may consist of a misdemeanor committed in the presence of the officer, a felony, or any crime in progress.

**3-151.1 COLONIAL BEACH POLICE ACTIVITIES**

Colonial Beach Police who observe or are notified of emergencies or criminal activities immediately adjacent to their town, but within Charles County, will:

- notify the Communications Section of the CCSO;
- respond to the scene;
- take appropriate action to protect lives and property;
- apprehend violators;
- recover contraband and evidence;
- restore the peace; and
- secure the scene awaiting arrival of the responding CCSO officers.

**3-151.2 CCSO COMMUNICATIONS RESPONSIBILITIES**

When notified of a need for police services within the area of Charles County adjacent to Colonial Beach, Virginia, the Communications employee will relay the request to the appropriate commander / supervisor. The appropriate supervisor will be the senior of:

- the Commander, District I;
- the Shift commander;
- the Supervisor, District I.

This notification will be by the most expeditious means. The Communications employee shall request the commander / supervisor assign the specific units (or a number of units) and the response code for those units. Communications dispatchers shall provide detailed directions to Colonial Beach for any responding unit who is not familiar with the route.

Any event which necessitates a significant response from the CCSO will require an immediate notification from the Communications Section to the Patrol operations commanders, or if unavailable, the Assistant Sheriff of Operations. This notification is in addition to any other required by this section.

**3-151.3 COMMANDER / SUPERVISOR’S RESPONSIBILITIES**

The commander / supervisor who is contacted by Communications shall evaluate the request for police service in that area of Charles County adjacent to Colonial Beach, Virginia. The commander / supervisor will decide the need for Agency response. If response is indicated, the units needed to respond shall be decided as well as their response code.

If the response is to be for a continuing crime, or an event requiring a significant investigation, a supervisor shall respond with the necessary manpower to handle the event or crime. The commander / supervisor shall maintain contact with Communications Section and request additional resources as are found to be needed.

**3-151.4 RESPONSIBILITIES OF SENIOR OFFICER / SUPERVISOR ON THE SCENE**

It shall be the responsibility of the senior sworn officer / supervisor on the scene at Colonial Beach, to assume supervision of the event and see to the proper discharge of all requirements of this section. The supervisor will coordinate activities with the Colonial Beach Police for use of their resources as necessary.



Administrative and Operational Manual

September 12, 2022

Sufficient information shall be gathered to confirm that any person taken into custody, or issued a criminal or civil summons, in fact committed a prosecutable offense within Charles County, Maryland. If a person is to be returned to Charles County for processing, it shall be determined that the person was arrested in Charles County, Maryland. If the person was arrested in Virginia, extradition proceedings must be instituted in order to return the person to Maryland.

In addition to any other reports or forms necessary as a result of response to Colonial Beach, the senior sworn officer / supervisor shall cause to be completed a Commanders' Information Report. The senior sworn officer / supervisor shall cause the names, addresses and telephone numbers, and such other information as may be necessary to contact individuals, to be gathered for each person who may be a witness or police officer involved in any activity associated with the reason for Charles County Sheriff's Office response to Colonial Beach.

If a priority response is to be made to Colonial Beach from Charles County, the senior sworn officer or supervisor will have the Communications Section make a courtesy call to the Maryland Transportation Authority Police at the Nice Bridge. Communications will also be required to contact the King George County Sheriff's and Westmoreland County Sheriff's Offices and notify them of the priority response through their jurisdictions. In cases of non-priority response, the notification is optional as time permits.

If the activities on the scene result in a court case in Charles County, the senior sworn officer or supervisor on the scene will make every effort to provide information and assistance to Colonial Beach officers who may be required to appear as witnesses in a Charles County Court. These officers may not be familiar with our court routine and should be briefed and supported to the degree necessary to make them feel a part of our police team.

### 3-151.5 RESPONSIBILITIES OF OFFICERS

All personnel responding to events at Colonial Beach will be mindful that their response must be completed safely in order to accomplish any law enforcement purpose. The response distance is in excess of 30 miles. Even priority responses must be made with the realization that circumstances requiring the response may be concluded prior to the officer's arrival on the scene. The officer must be particularly mindful of the exposure to danger created by such a long priority response and keep safe driving tactics as a primary concern.

Charles County Sheriff's Officers will write any necessary reports concerning events occurring within Charles County. Additionally, they will take charge of any prisoners arrested in Charles County for offenses occurring in Charles County. These persons will be processed in the normal manner dependent upon their crimes and age. In the case of juvenile arrests, where the juvenile is to be released, the juvenile forms may be completed in Colonial Beach and the release completed at that location. A supply of forms shall be stocked at the Colonial Beach Police Department to facilitate this process.

Adults to be given citations may be given those citations and released on the scene. Any adult who is to be fingerprinted and photographed shall be returned to the Charles County Detention Center for such processing.

All evidence or property collected with regard to an event occurring within Charles County shall be gathered by the Charles County officers and handled in the usual manner. Any Colonial Beach officer who is a part of the chain of custody shall be formally included in that chain of custody, including a signature on the necessary documents.

Officers will prominently mark all reports resulting from incidents, in which Colonial Beach officers participated, with the words, "Copy to Colonial Beach P D." This will alert Records Section to send a copy to the Colonial Beach Police Department.

Officers who are in Colonial Beach as a result of a response under this section, are empowered to act as law enforcement officers within Colonial Beach. They may do so for in-progress crimes or in response to emergencies. Officers so engaged, have all the immunities from liability and exemption from laws, ordinances and regulations, and have all the pension, relief, disability, workers' compensation and other benefits within the jurisdictional limits





Administrative and Operational Manual

September 12, 2022

of the Charles County Sheriff's Office.

### 3-151.6 RECORDS SECTION RESPONSIBILITIES

The Deputy Director, Records Management Section will require any report, marked with the notation, "Copy to Colonial Beach P D," be copied and mailed to the Colonial Beach Police Department. Any copy of a report regarding an incident occurring within Charles County, which is written by Colonial Beach officers, received by Records Section, will be:

- copied and sent to the involved officer(s);
- copied and sent to the Commander, CID; and
- placed in the Records file with the original case report written by Charles County officers.

### 3-151.7 RESPONSIBILITIES OF COLONIAL BEACH POLICE

Colonial Beach officers are empowered to act in an emergency within Charles County adjacent to Colonial Beach. Arrests made or evidence and property recovered as a result of such activities shall be turned over to Charles County Sheriff's Officers. Colonial Beach officers will provide information as witnesses for reports and in court. The Colonial Beach Police Department will provide to the Charles County Sheriff's Records Section, copies of any reports they write in conjunction with their response to incidents within Charles County.

### 3-152 MEMORANDUM OF UNDERSTANDING (MOU) - KING GEORGE COUNTY, VA. SHERIFF'S OFFICE

The Charles County Sheriff's Office and the King George County, Virginia, Sheriff's Office have entered into a Memorandum of Understanding concerning police services provided to that area of Charles County, which is immediately adjacent to King George County, Virginia. This section outlines the MOU and provides guidance to employees of the CCSO when they are called upon to respond to calls for service in this area.

The original MOU was signed on July 8, 1999. A copy of the MOU is filed in the Office of the Sheriff. The MOU remains in effect until canceled or revised by one of the Chief Executives of either Law Enforcement Agency.

The MOU essentially provides that the King George County Sheriff's Office may make an initial response to emergency needs for police services in those areas of Charles County adjacent to King George County, Virginia. It further provides that the assistance and resources of each Agency may be requested and received, one from the other, at the discretion of the providing Agency. Follow-up investigations remain the responsibility of the Agency which has original jurisdiction.

"Emergency," as used in the agreement, may consist of a misdemeanor committed in the presence of the officer, a felony or any crime in progress.

#### 3-152.1 KING GEORGE COUNTY SHERIFF'S ACTIVITIES

King George County Sheriff's Officers who observe or are notified of emergencies or criminal activities immediately adjacent to their County, but within Charles County, will:

- notify the Communications Section of the CCSO;
- respond to the scene;
- take appropriate action to protect lives and property;
- apprehend violators;



**Administrative and Operational Manual**

**September 12, 2022**

- recover contraband and evidence;
- restore the peace; and
- secure the scene awaiting arrival of the responding CCSO officers.

**3-152.2 CCSO COMMUNICATIONS RESPONSIBILITIES**

When notified of a need for police services within the area of Charles County adjacent to King George County, Virginia, the Communications employee will relay the request to the appropriate commander / supervisor. The appropriate supervisor will be that which is available in descending order:

- the Commander, District I;
- the Shift commander;
- the Supervisor, District I.

This notification will be by the most expeditious means. The Communications employee shall request the commander / supervisor assign the specific units (or a number of units) and the response code for those units. Police Communications officers shall provide detailed directions to Fairview Beach or any other area in King George County, Virginia, for any responding unit which is not familiar with the route.

Any event which necessitates a significant response from the CCSO will require an immediate notification from the Communications Section to the Patrol operations commanders, or if unavailable, the Assistant Sheriff. This notification is in addition to any other required by this section.

**3-152.3 COMMANDER / SUPERVISOR'S RESPONSIBILITIES**

The commander / supervisor who is contacted by Communications shall evaluate the request for police service in that area of Charles County adjacent to King George County, Virginia. The commander / supervisor will decide the need for Agency response. If response is indicated, the units needed to respond shall be decided as well as their response code.

If the response is to be for a continuing crime, or an event requiring a significant investigation, a supervisor shall respond with the necessary manpower to handle the event or crime. The commander / supervisor shall maintain contact with the Communications Section and request additional resources as are found to be needed.

**3-152.4 RESPONSIBILITIES OF SENIOR OFFICER / SUPERVISOR ON THE SCENE**

It shall be the responsibility of the senior sworn officer / supervisor on the scene at Fairview Beach, or any other location adjacent to King George County, Virginia, to assume supervision of the event and see to the proper discharge of all requirements of this section. The supervisor will coordinate activities with the King George County Sheriff's Office for use of their resources as necessary.

Sufficient information shall be gathered to confirm that any person taken into custody, or issued a criminal or civil summons, in fact committed an offense which can be prosecuted within Charles County, Maryland. If a person is to be returned to Charles County for processing, it shall be determined that the person was arrested in Charles County, Maryland. If the person was arrested in Virginia, extradition proceedings must be instituted in order to return the person to Maryland.

In addition to any other reports or forms necessary as a result of response to King George County, Virginia, the senior sworn officer / supervisor shall cause to be completed a Commanders' Information Report. The senior sworn officer / supervisor shall cause the names, addresses and telephone numbers, and such other information as may be necessary to contact individuals, to be gathered for each person who may be a witness or police officer involved in any activity associated with the reason for Charles County Sheriff's Office response to King George County, Virginia.



Administrative and Operational Manual

September 12, 2022

If a priority response is to be made to King George County, Virginia, from Charles County, the senior sworn officer or supervisor will have the Communications Section make a courtesy call to the Maryland Transportation Authority Police at the Nice Bridge. In cases of non-priority response, the notification is optional as time permits.

If the activities on the scene result in a court case in Charles County, the senior sworn officer or supervisor on the scene will make every effort to provide information and assistance to King George County Sheriff's Officers who may be required to appear as witnesses in a Charles County Court. These officers may not be familiar with our court routine and should be briefed and supported to the degree necessary to make them feel a part of our police team.

### 3-152.5 RESPONSIBILITIES OF OFFICERS

All personnel responding to events in King George County will be mindful that their response must be completed safely in order to accomplish any law enforcement purpose. The response distance to Fairview Beach is in excess of 30 miles. Even priority responses must be made with the realization that circumstances requiring the response may be concluded prior to the officer's arrival on the scene. The officer must be particularly mindful of the exposure to danger created by such a long priority response and keep safe driving tactics as a primary concern.

Charles County Sheriff's Officers will write any necessary reports concerning events occurring within Charles County. Additionally, they will take charge of any prisoners arrested in Charles County for offenses occurring in Charles County. These persons will be processed in the normal manner dependent upon their crimes and age. In the case of juvenile arrests, where the juvenile is to be released, the juvenile forms may be completed either on the scene or at the King George County Sheriff's Office and the release completed at that location. A supply of forms shall be stocked at the King George County Sheriff's Office to facilitate this process.

Adults to be given citations may be given those citations and released on the scene. Any adult who is to be fingerprinted and photographed shall be returned to the Charles County Detention Center for such processing.

All evidence or property, collected with regard to an event occurring within Charles County shall be gathered by the Charles County officers and handled in the usual manner. Any King George County Sheriff's Officer who is a part of the chain of custody shall be formally included in that chain of custody, including a signature on the necessary documents.

CCSO officers will prominently mark all reports resulting from incidents, in which King George County Sheriff's Officers participated, with the words, "Copy to King George County, Virginia, Sheriff's Office." This will alert Records Section to send a copy to the King George County, Virginia, Sheriff's Office.

CCSO officers who are in King George County, Virginia, as a result of a response under this section, are empowered to act as law enforcement officers within King George County, Virginia. They may do so for in-progress crimes or in response to emergencies. Officers so engaged, have all the immunities from liability and exemption from laws, ordinances and regulations, and have all the pension, relief, disability, workers' compensation and other benefits as they would within the jurisdictional limits of the Charles County Sheriff's Office.

### 3-152.6 RECORDS SECTION RESPONSIBILITIES

The Deputy Director, Records Management Section will require any report, marked with the notation, "Copy to King George County, Virginia, Sheriff's Office" be copied and mailed to the King George County, Virginia, Sheriff's Office. Any copy of a report, regarding an incident, occurring within Charles County, which is written by King George County, Virginia, Sheriff's Officers, received by Records Section, will be:

- copied and sent to the involved officer(s);



**Administrative and Operational Manual**

**September 12, 2022**

- 
- copied and sent to the Commander, CID; and
  - placed in the Records file with the original case report written by Charles County Officers.

**3-152.7 RESPONSIBILITIES OF KING GEORGE COUNTY, VA. SHERIFF'S OFFICERS**

King George County, Virginia, Sheriff's Officers are empowered to act in an emergency within Charles County adjacent to King George County, Virginia. Arrests made or evidence and property recovered as a result of such activities shall be turned over to Charles County Sheriff's Officers. King George County, Virginia, Sheriff's Officers will provide information as witnesses for reports and in court. The King George County, Virginia, Sheriff's Office will provide to the Charles County Sheriff's Records Section, copies of any reports they write in conjunction with their response to incidents within Charles County.



Administrative and Operational Manual

September 12, 2022

### **3-155 MOU - CHARLES COUNTY BOARD OF EDUCATION**

The Sheriff has entered into an agreement with the Charles County Board of Education to empower the Sheriff to carry out the responsibilities of the Education Article (ED § 26-102). Under this section, the governing board of any public institution of elementary, secondary, or higher education may enter into an agreement with appropriate law enforcement agencies to carry out the responsibilities of the section when:

- The institution is closed; or
- None of the persons designated in Section 3-155.1 are present in the buildings or on the grounds of the institution.

#### **3-155.1 PERSONS WHO MAY DENY ACCESS TO SCHOOL GROUNDS**

The governing board, president, superintendent, or principal, of any public institution of elementary, secondary, or higher education, or a person designated in writing by the board or any of these persons, may deny access to the buildings or grounds of the institution if the conditions in Section 3-155.2 are met.

#### **3-155.2 DENYING ACCESS**

Sworn employees may deny access to the buildings or grounds, of the various institutions of the Charles County Board of Education, to any person who:

- Is not a bona fide, currently registered student, or staff or faculty member at the institution, and who does not have lawful business to pursue at the institution; or
- Is a bona fide, currently registered student at the institution and has been suspended or expelled from the institution, for the duration of the suspension or expulsion; or
- Acts in a manner that disrupts or disturbs the normal educational functions of the institution.

#### **3-155.3 PENALTIES**

Persons found guilty of violating the provisions of ED § 26-102 are guilty of a misdemeanor and on conviction are subject to a fine not exceeding \$1,000, imprisonment not exceeding 6 months, or both if the violator:

- Trespasses on the grounds of any public institution of elementary, secondary, or higher education;
- Fails or refuses to leave the grounds of any of these institutions after being requested to do so by an authorized employee of the institution;
- Willfully damages or defaces any building, furnishing, statue, monument, memorial, tree, shrub, grass, or flower on the grounds of any of these institutions.

#### **3-155.4 CAUTIONS**

Employees are cautioned that this section only empowers the Sheriff when there is no representative of the school present when the trespass occurs. In effect, the section empowers the Sheriff as the complainant (property owner) if the conditions of the section are met.



Administrative and Operational Manual

September 12, 2022

**3-156 MEMORANDUM OF UNDERSTANDING WITH THE LA PLATA POLICE DEPARTMENT**

The Charles County Sheriff's Office and the La Plata Police Department have signed a Memorandum of Understanding (MOU) to govern the interactions of the two Agencies. The MOU was created in order that the best possible service might be rendered to the citizens of Charles County and the Town of La Plata by both Agencies. This can be done through the cooperative efforts of the two Agencies in coordinating the delivery of services.

This MOU provides that certain responsibilities will be primary for each Agency. The Agency which is not primary will provide supporting services to the other upon request. The MOU also provides for the sharing of information and reporting of activities in a manner which best serves the citizens of the County and the Town of La Plata.

The La Plata Police Department and the Charles County Sheriff's Office have joint jurisdiction within the incorporated Town of La Plata. However, the La Plata Police Department shall have the primary responsibility for all requests for police services, enforcement of traffic laws, and investigation of all traffic accidents within the incorporated Town of La Plata except as enumerated within this MOU below:

**3-156.1 CALLS FOR SERVICE IN THE TOWN OF LA PLATA, MARYLAND**

**TRAFFIC INVESTIGATIONS**

The La Plata Police Department will have the primary responsibility for traffic related activities such as disabled vehicles, roadway hazards, and point of traffic control.

In the event a member of the Charles County Sheriff's Office or the La Plata Police Department witnesses or arrives at the scene of a minor traffic incident (i.e., disabled vehicle, traffic violation, property damage accident), that member will handle the incident unless committed to an assignment of a higher priority.

The La Plata Police Department will have primary responsibility for all non-criminal serious and fatal motor vehicle collisions occurring within the Town limits. The Charles County Sheriff's Traffic Operations Unit will provide assistance as requested and will take on the responsibility of the lead investigative unit upon the request of the La Plata Police Department.

The Charles County Sheriff's Office will be responsible for the investigation of all motor vehicle traffic accidents which involve county-owned vehicles within the incorporated Town of La Plata.

The La Plata Police Department will be responsible for the investigation of all motor vehicle traffic accidents which involve vehicles owned by the Town of La Plata within the incorporated Town of La Plata.

The Charles County Sheriff's Office will further be responsible for the investigation of all motor vehicle accidents involving county-owned and privately-owned school buses used for the transportation of students associated with the Charles County Board of Education, private contractors, and related activities on all roadways within the incorporated Town of la Plata.

There is nothing to prevent either agency upon request and agreement from yielding the investigation to the other.

**COMMUNICATIONS**

The Charles County Sheriff's Office shall provide communications capabilities to the la Plata Police Department. It is the responsibility of the La Plata Police Department to purchase and maintain portable and mobile radios for its officers and vehicles that are compatible with the specifications dictated by the Charles County Sheriff's Office.

**CRIMINAL INVESTIGATIONS**



Administrative and Operational Manual

September 12, 2022

The La Plata Police Department will have the primary responsibility for the investigation of criminal complaints within the incorporated Town of La Plata except as enumerated herein:

The Charles County Sheriff's Office will have the primary responsibility for the investigation of the following crimes:

- Deaths (unless natural);
- Shootings (unless accidental);
- Felony assaults, with life threatening injuries;
- Rape;
- Sexual offenses (except fourth degree);
- Commercial robbery;
- Kidnapping / abduction;
- Child abuse;
- Elderly abuse;
- Forgery and related crimes over \$50,000;
- Credit card fraud over \$50,000;
- Other crimes that are currently above the resources of the La Plata Police Department;
- Officer involved Use of Deadly Force.

The La Plata Police Department will be made aware of all of the crimes listed above that occur in the incorporated Town of la Plata, and its detective unit will assist with the investigation whenever feasible.

The La Plata town Police Department will have primary responsibility for responding to and the investigation of instances where a citizen reports a crime or requests police services other than those enumerated in paragraph (1) of this section. This does not preclude an officer from the Charles county Sheriff's Office from taking over the primary responsibility for any in-person request for service which requires immediate attention, for investigating a crime in which they are a witness, or when due to manpower, or in those instances where the La Plata Police Department are unavailable.

The Charles County Sheriff's Office will have the primary responsibility for the investigation of all criminal offenses committed on county-owned or county-managed property, including buildings housing the office of county agencies, and all county operated correctional facilities in the incorporated Town of La Plata.

The La Plata Police Department will advise and consult with the Charles County Sheriff's Office, Criminal Investigations Division, on all crimes that occur within the Town of La Plata where said crime has a nexus to crimes outside the La Plata Police Department jurisdiction being investigated by the Charles County Sheriff's Office. After the consultation, the La Plata Police Department investigation may be reassigned to the Charles County Sheriff's Office.

Response to in-progress criminal incidents may be provided by either agency.

**ORGANIZED CRIME, CRIMINAL CONSPIRACIES, AND INTELLIGENCE GATHERING**

The Charles County Sheriff's Office and the La Plata Police Department are both responsible for gathering information about organized criminal activity, criminal conspiracies, and all other criminal activity which may affect either Agency. The investigative components of the Charles County Sheriff's Office and the La Plata Police Department shall cooperate to the fullest extent possible in the gathering of information described in this paragraph.

**NATURAL AND MAN-MADE DISASTERS AND CIVIL DISTURBANCES**

**Administrative and Operational Manual****September 12, 2022**

Through the authority of the Federal Civil Defense Act of 1950, P.L. 81-290, Md. Pub. Safety Code Ann. § 14-101 *et seq.*, the Charles County Government has established an "Emergency Operations Plan." The plan establishes a comprehensive emergency management program to respond to natural disasters, man-made disasters, and civil emergencies and assigns functions and responsibilities to all government agencies, including law enforcement agencies, to support the coordinated management of said emergencies.

Under the terms of the Emergency Operations Plan, the Charles County Sheriff's Office is responsible for coordinating emergency law enforcement within the county during periods of disaster or civil unrest which originate or expand outside the incorporated Town of La Plata. The La Plata Police Department shall coordinate incidents within the incorporated Town of La Plata with assistance and support of the Charles County Sheriff's Office as per the Emergency Operations Plan for the incorporated Town of La Plata unless by request and acceptance, the incident shall be turned over to the Charles County Sheriff's Office.

**3-156.2 MUTUAL ASSISTANCE AND TIMELY RESPONSE**

The La Plata Police Department shall provide 24-hour police coverage within the incorporated Town of La Plata. Should a shortage of manpower exist and the La Plata Police Department is unable to provide coverage, the on-duty operational commander for the Charles County Sheriff's Office shall be notified and, if allowed by available resources, the Charles County Sheriff's Office shall assign a unit to work the Town of La Plata. If available resources limit this assignment, the Charles County Sheriff's Office shall still become the first responder to calls within the incorporated Town of La Plata.

The officers of the Town of La Plata Police Department, when requested by the Sheriff's Office, may respond in a mutual aid capacity outside the incorporated Town of La Plata but within Charles County. This authority will be limited to responses at the specific request of the Charles County Sheriff's Office, unless the officer is rendering assistance to another police officer in conformance with Annotated Code of Maryland, Criminal Procedure Article § 2-102(b)(3)(i).

In the event it becomes necessary for the Charles County Sheriff's Office or the La Plata Police Department to request the assistance of the other agency in fulfilling the responsibilities conferred in this Memorandum, or any other law enforcement responsibility, such assistance will be provided, subject to available resources.

Should either agency be unable to respond in a timely manner to any call for service in its primary areas of responsibility, the non-primary agency will be requested to respond.

**WARRANT SERVICE**

The Charles County Sheriff's Office will assume primary responsibility for the processing and service of warrants as issued through the District Court Commissioner unless specifically requested that the warrant be returned to an officer of the La Plata Police Department for service.

**FUGITIVE WARRANTS**

If a subject wanted on out-of-state charges is located by the La Plata Police Department and there are Charles County charges, the fugitive TTYs confirming the request for extradition will be obtained by the arresting officer and left with the detention center as a detainer. There will be no fugitive charges filed until the subject is released from custody on local charges.

If a subject wanted on out-of-state charges is located by the La Plata Police Department and there are no local charges, the subject will be turned over to the Charles County Sheriff's Office for charging as a fugitive.

**INTENT OF MEMORANDUM**

Nothing in this Memorandum shall be construed to limit the authority provided to either party under the Md. Crim.





**Administrative and Operational Manual**

**September 12, 2022**

Proc. Code Ann. § 2-202 or other applicable law.

**LIABILITY**

Each of the parties to this Memorandum agrees to indemnify and save harmless the other party against any and all claims by third parties for property damage or personal injury arising from each party's respective activities performed under this Memorandum and agrees to waive any and all claims against the other party which may arise out of the activities performed under this Memorandum. Each part shall remain liable for the acts or omissions of its own employees to the extent permitted by applicable law. Nothing in this Memorandum shall be construed to waive any immunities or privileges afforded by law.

**INTERPRETATION OF THIS MEMORANDUM**

Conflicts of interpretation of this Memorandum will be resolved at the operational levels of both agencies, where possible. Issues remaining unresolved at the operational level will be resolved by the managements of the Charles County Sheriff's office and the La Plata Police Department.

This Memorandum is intended to coordinate law enforcement efforts by the parties. It shall not be construed to alter or affect the jurisdiction or authority of either party to enforce all state and local laws within the incorporated Town of La Plata; nor shall it be construed to alter existing responsibilities of either party for the acts or omissions of its employees and agents.

**FINANCIAL AGREEMENT**

Both the Charles county Sheriff's Office and the la Plata Police Department will be responsible for associated costs of services, to include overtime, while providing mutual aid to the other agency.

**DOCUMENTATION OF MUTUAL AID**

Whenever significant mutual aid is provided by either the Charles County Sheriff's Office or the La Plata Police Department, an "assist other agency" report will be prepared when mutually agreed upon by both agencies' shift supervisors. The report will be forwarded to the agency providing the mutual aid.

**CONTROL OF PERSONNEL AND USE OF EQUIPMENT AND FACILITIES**

Unless agreed upon by the executive officers of both agencies or through another written agreement, both agencies will maintain control over the supervisor of their personnel under this memorandum. The use of equipment and facilities will be determined on a case-by-case basis by the on-scene supervisors or commanders of each event.

**RENEWAL AND MODIFICATION**

The Charles County Sheriff's Office and the La Plata Police Department agree to establish appropriate protocol and regulations necessary to implement this agreement.

**TERM OF AGREEMENT**

This Memorandum is self-renewing unless terminated by either party upon 30-days advance written notice to the chief law enforcement executive of the other party. Either party can request modifications or a review of the memorandum at any time. Review of the memorandum will occur on an as-needed basis as determined.



Administrative and Operational Manual

September 12, 2022

The Charles County Sheriff's Office (CCSO) and the Charles County Department of Emergency Services (DES) have signed a Memorandum of Understanding (MOU) to govern the interactions of the two Agencies. The MOU was created in order that the best possible service might be rendered to the citizens of Charles County by both Agencies during certain high risk events that occur in Charles County, Maryland.

**3-160.1 BACKGROUND AND PURPOSE**

The purpose of this MOU is to form a common understanding and agreement between the parties regarding requests for the use and collaborative support of response groups used during certain high risk events including but not limited to, events involving hazardous materials, weapons of mass destruction (WMD) and Chemical Biological Radiological Nuclear and Explosive (CBRNE) mitigation for homeland security missions and other emergency situations which require joint special operations.

The DES is an agency established by the county to provide emergency medical support and services to the citizens of Charles County, Maryland.

The CCSO is a full- service law enforcement agency responsible for preventing and investigating crimes within Charles County, Maryland.

The response groups that address the needs of both law enforcement and emergency response include but are not limited to, the Emergency Medical Services (EMS) non emergent stand-by response group, the tactical emergency medical service response group and the hazardous materials (HazMat) response group.

This MOU will outline each party's responsibilities in providing personnel, funding, program administration and other resources to support the collaborative effort.

**3-160.2 ROLES AND RESPONSIBILITIES**

**RESPONSE GROUPS/ PROGRAMS/ PERSONNEL-** Each agency will assign personnel from their agency as follows:

DES manages and maintains the following response groups and agrees to provide County personnel to support CCSO missions when requested:

- Tactical Emergency Medical Services (TEMS) – is comprised of tactical emergency medical technicians certified, trained, and equipped to provide emergency medical care and support to the CCSO Emergency Services Team (EST) during high risk missions including but not limited to warrants, counterterrorism, and events involving and CBRNE.
- Hazardous Materials (HazMat)- is comprised of hazardous material technicians, supervisors, and commanders certified, trained and equipped to respond to and mitigate hazardous material incidents including, but not limited to, clandestine chemistry (drug lab), WMD, and CBRNE events.
- Medical Standby- is comprised of emergency medical technicians licensed, certified, trained and equipped to provide medical care and support at the Southern Maryland Criminal Justice Academy or other locations.

CCSO agrees to provide personnel to actively participate in the following response groups:

- Hazardous Materials (HazMat)- CCSO will allow employees who are certified, trained and equipped to actively participate with members of the DES HazMat Team to mitigate hazardous material incidents, including but not limited to, clandestine chemistry (drug lab), WMD, and CBRNE events.

The Parties agree:



**Administrative and Operational Manual**

**September 12, 2022**

- To provide trained and credentialed personnel as well as all necessary apparatus, vehicles, and equipment to support each agency's respective mission, requests and training activities.
- DES will provide all appropriate training, equipment, and personal protective equipment to each agency's personnel actively engaged as members of the HazMat response group.
- CCSO will provide all appropriate training, equipment, and personal protective equipment to DES personnel actively engaged as members of the TEMS response group.
- To conduct all operations in compliance with the policies, standards operational procedures or guidelines of each agency and the standards and practices of the National Incident Management System (NIMS).
- To ensure that all personnel conduct operations in strict accordance with the adopted Standard Operational Guidelines applicable to their respective disciplines. To facilitate adherence to the Standard Operating Guidelines, DES shall provide CCSO with copies of the Standard Operation Guidelines for TEMS and HazMat; CCSO shall provide DES with copies of the Standard Operating Guidelines for EST.

**3-160.3 OPERATIONAL GUIDELINES**

This section designates the financial responsibilities of each Agency as it relates to this MOU.

**Uniforms and Personal Protective Equipment (PPE):**

- DES personnel actively engaged in TEMS support to EST missions or training activities will wear the prescribed duty uniform and equipment as supplied by CCSO.
- CCSO personnel actively engaged in HazMat missions or training activities will wear the prescribed duty uniform and equipment as supplied by DES.
- CCSO and CCDES will be individually responsible for ensuring that the uniforms and equipment provided to all response groups/ special operations personnel are compliant with OSHA/ MOSHA regulations, CCSO and DES adopted standards, and applicable NFPA Guidelines formally adopted by Charles County Government.

**Payroll of special team members:**

- All personnel expenses associated with DES personnel being actively engaged in TEMS missions, TEMS training activities and/ or Academy or marine unit medical standby at the request of CCSO, will be authorized and paid for from a CCSO payroll account.
- All personnel expenses associated with CCSO personnel being actively engaged in HazMat missions or training activities will be authorized and paid for from a DES payroll account.

**Operation and maintenance of Apparatus, Vehicles, and Equipment:**

- The head of each agency's Field Operations Section will act as the liaison for matters involving equipment, equipment maintenance, vehicle readiness, and operation/maintenance of vehicles.
- Each agency agrees that their employees participating in a response group will maintain the proper certifications and credentials required to participate in that response group.
- For the purpose of this MOU a "vehicle" shall include all motorized and non-motorized vehicles, including but not limited to, land and sea vessels, ATV's, motorcycles, motor scooters, mopeds, motorized minibikes, bicycles, scooters, skateboards, animals, trailers, semi-trailers, pole trailers, travel trailers, towed vehicles



Administrative and Operational Manual

September 12, 2022

and equipment, special mobile equipment, as well as emergency vehicles, motor vehicles, and vehicles generally, as defined in the Annotated Code of Maryland, Transportation Article, §11-118, §11-135 and §11-176.

- Each agency is responsible for maintaining all equipment that either agency issued to their personnel and for ensuring that all equipment is in good working order prior to each use.
- Prior to operating any equipment, vehicles or apparatus, the individual operator will be trained or appropriately licensed in accordance with Maryland Law and the standards set forth by the respective agency owner of the equipment. Records of training will be maintained for DES by the Assistant Chief of Special Operations and for CCSO by the fleet service coordinator.
- In the event of a vehicle crash or damage, the agency that owns the vehicle will notify the other agency of the incident and will provide reports, related documentation, and disposition to the County Risk Manager and Fleet Service Coordinator.
- In the event of a vehicle crash or damage, the Charles County Accident Review Committee and the CCSO Collision Committee shall coordinate and review the incident, prepare a report, and formulate recommendations. The report and recommendations will be provided to DES and CCSO, who will review the report and recommendations and each will determine whether disciplinary action will be made based on the individual department's policies and procedures. Casualty losses and repairs shall be paid by the agency owning the vehicle.

**Reporting/ Chain of Command:**

- CCSO personnel assigned to the HazMat response group will comply with the command and control structure as established in the DES HazMat Standard Operating Guidelines.
- DES personnel assigned to the TEMS response group will comply with the command and control structure as established in the CCSO Policy and Procedure Manual, as well as any EST Standard Operational Guidelines.
- Response Groups- During mission deployments both parties agree when employees are acting as part of a response group (i.e. sworn CCSO members are participating in a HazMat response or TEMS personnel on an EST incident) their primary responsibility will be duties related to that particular response group assignment.

**3-160.4 GENERAL TERMS**

**DURATION:** This MOU will become effective upon signature of all parties and may be terminated by either party without cause by providing sixty (60) days written notice.

**REVIEW AND AMENDMENT:** This MOU will be reviewed annually and may be amended from time to time with the mutual written agreement of the parties.

**POINTS OF CONTACT:** The following personnel will be the point of contact for their respective agency with regard to this Agreement:

DES:

Assistant Chief of Special Operations  
10425 Audie Lane  
La Plata, MD 20646

CCSO:

Special Operations Division Commander  
6915 Crain Hwy  
La Plata, MD 20646

**LIABILITY:** Each party shall remain liable for acts or omissions of its own employees within the limits of applicable law. Nothing in this Agreement shall be construed to waive any immunities or privileges afforded by law.





Administrative and Operational Manual

September 12, 2022

[Redacted text block]

[Redacted text block]

[Redacted text block]

[Redacted text block]

[Redacted text block]

[Redacted text block]

[Redacted text block]

[Redacted text block]

[Redacted text block]

[Redacted text block]

[Redacted text block]

[Redacted text block]

[Redacted text block]



Administrative and Operational Manual

September 12, 2022

[REDACTED]

[REDACTED]

- [REDACTED]
- [REDACTED]
- [REDACTED]
- [REDACTED]
- [REDACTED]
- [REDACTED]



Administrative and Operational Manual

September 12, 2022

[Redacted text block]

[Redacted text block]

[Redacted text block]

- [Redacted list item]
- [Redacted list item]
- [Redacted list item]

[Redacted text block]

- [Redacted list item]
- [Redacted list item]
- [Redacted list item]

[Redacted text block]





## Administrative and Operational Manual

September 12, 2022

### 3-162 MUTUAL AID AGREEMENTS - CALVERT COUNTY SHERIFF'S OFFICE AND ST. MARY'S COUNTY SHERIFF'S OFFICE

Recognizing it is in the public interest that law enforcement agencies throughout the State of Maryland cooperate to the greatest extent possible to provide prompt, effective, and professional law enforcement services, this Agency has entered into a mutual aid agreement with the listed counties' law enforcement agencies. This agreement allows us, in accordance with Criminal Procedure, § 2-105 of the Annotated Code of Maryland, to provide assistance to, and request assistance from, police agencies in neighboring jurisdictions and to enter into joint law enforcement initiatives to include task forces and regional multi-jurisdictional initiatives. This MOU may be immediately canceled at any time by any one of the Sheriffs of the respective Law Enforcement Agency.

#### 3-162.1 DEFINITIONS

The following definitions apply to this section of policy:

- The law enforcement officer who enters the jurisdiction of another party to this Agreement shall be the "Entering Officer";
- The jurisdiction into which a law enforcement officer enters under this agreement shall be the "Entered Jurisdiction";
- The law enforcement agency of the jurisdiction into which a law enforcement officer enters under this Agreement shall be the "Entered Agency".

**Exigent Circumstance** - Can include such incidents as criminal law violations that occur in the presence of an officer; incidents having an increased potential of health or safety hazard, such as observed actions requiring an emergency evaluation / commitment, reckless endangerment, or a serious traffic violation such as possible DWI; hit and runs or other moving violations which are classified as must appear offenses.

#### 3-162.2 GENERAL REQUIREMENTS

In all exigent circumstance of law enforcement action, peace officer action and judicial officer action, notification shall be made as soon as possible to CCSO Communications, which will immediately notify the "Entered Agency" for said jurisdiction. The Entered Agency shall have the authority to assume command of the incident. The CCSO officer should not complete any type of additional investigation or complete any charging documents until the "Entered Agency" has refused to assume command. In the event the "Entered Agency" does assume command, the CCSO officer shall cooperate fully with the investigation and shall assume the responsibility to appear in any court proceeding. Failing to appear in court may cause a body attachment to be issued by the courts for your immediate appearance. Unless such exigent circumstances dictate otherwise, the following guidelines will be adhered to:

- The Entering Officer may lawfully go or be sent beyond the boundaries of their own County's jurisdiction and may make arrests, conduct investigations, and otherwise enforce the laws of the State of Maryland without limitations as to jurisdiction and without the presence of a law enforcement officer from the Entered Jurisdiction, provided the Communications Section provides the Entered Jurisdiction:
  - notice when a Charles County officer enters the jurisdiction to conduct police activities;
  - the type and location of law enforcement activity;
  - whether any of the Entering Officers will be in plainclothes; and
  - an opportunity to be present during the law enforcement activity.
- The Entering Officer is authorized to act as a law enforcement officer in the Entered Jurisdiction, if the actions are in accordance with the policies and regulations of the employing agency.

It shall be the policy of the Charles County Sheriff's Office that officers shall not enforce common, routine traffic



**Administrative and Operational Manual**

**September 12, 2022**

violations in other jurisdictions. This policy shall not affect those instances pertaining to vehicle pursuits or the elements of fresh pursuit. In those cases, current Agency policy will be followed.

Parties to this agreement may enter into joint law enforcement initiatives to include task forces and regional multi-jurisdictional initiatives as considered necessary. Each such agreement shall spell out duties and responsibilities for the term of the task force or initiative and be approved by the affective Sheriff or his designee.

**3-162.3 RESPONSIBILITIES - COMMUNICATIONS**

Upon being contacted by a neighboring jurisdiction requesting assistance under this agreement, Charles County Sheriff's Office Communications Officers will:

- Determine the:
  - nature of the call;
  - number of officers being requested;
  - equipment needed, if any; and
  - name and location of the requesting Agency's supervisor to which CCSO officers will report.
- at once contact the district commander, shift commander or sector supervisor, whichever is immediately available for approval of the request;
- dispatch the needed units and equipment as determined by the appropriate commander / supervisor; and
- relay the response information, including estimated response time to the requesting Agency.

Upon being advised by a sector supervisor or district / shift commander of the need to request assistance from a neighboring jurisdiction, CCSO Communications officers will:

- immediately contact the Communications section of the assisting Agency and provide them with the following information:
  - the nature of the request;
  - the number of officers needed;
  - equipment needed, if any; and
  - the name and location of the CCSO supervisor / commander to which the assisting officers will report; and
- obtain the estimated response time from the assisting agency.

**3-162.4 RESPONSIBILITIES - COMMAND / SUPERVISION**

Upon determining the need for assistance from a neighboring jurisdiction, the appropriate commander / supervisor will contact CCSO Communications and direct the approved procedure for such requests be followed.

If the commander / supervisor receives a request for assistance from a neighboring jurisdiction, he will determine the availability of the manpower or equipment needed, and make all reasonable efforts to accommodate the request.

If an unusual or serious incident occurs involving a CCSO officer, the commander, / supervisor, as appropriate will respond to the scene of the incident.

The commander / supervisor will ensure that all necessary reports are completed and distributed as required elsewhere in this policy and Manual, and that all necessary notifications are made.



Administrative and Operational Manual

September 12, 2022

---

### 3-162.5 RESPONSIBILITIES - RESPONDING OFFICERS

In accordance with this policy, officers will only be dispatched into neighboring jurisdictions by command or supervisory authority, and will comply with this and all other CCSO policy and procedure.

Upon being released by the officer in charge, officers will immediately return to Charles County and advise Communications as such.

CCSO officers shall have authority to use deadly force only in defense of an attack that may result in death or serious bodily injury to the officer, other officers present, or innocent bystanders.

Prior to securing from duty, assisting officers will complete a Commanders' Information Report detailing the circumstances of the incident. Officers who are in a neighboring jurisdiction because of this agreement have all the immunities from liability and exemption from laws, ordinances and regulations, and have all pensions, relief, disability, workers' compensation and other benefits enjoyed within the jurisdictional limits of the Charles County Sheriff's Office.



## Administrative and Operational Manual

September 12, 2022

### 3-163 MEMORANDUM OF AGREEMENT FOR JOINT INVESTIGATIVE PROCEDURES OF CHILD PHYSICAL AND SEXUAL ABUSE

For the purpose of determining criminal issues, reducing trauma to victims, and decreasing the potential for physical harm to children, the Charles County Sheriff's Office (CCSO), Maryland State Police (MSP), Charles County Department of Social Services (DSS), Charles County Public Schools (CCPS), County Attorney's Office, State's Attorney's Office and the Maryland State Department of Education, Office of Child Care (MSDE, OCC) have entered into an agreement for conducting joint investigations, as mandated by law, into cases of alleged physical and sexual abuse of children.

The agreement outlines each agency's responsibilities during an investigation:

- The CCSO shall be responsible for all aspects of the criminal investigation.
- Child Protective Service Workers from the Department of Social Services shall be responsible for assessing safety of all children in a home or child care center and provision of needed services to the family.
- The Maryland State Department of Education, Office of Child Care (MSDE, OCC) is responsible for assessing the health and safety of children in care and shall determine when a registered family child care home or licensed child care center remains open.
- The Charles County Public Schools shall determine the appropriate personnel action to take with employees. CCPS will also make available a staff member during any interview with a child.
- The State's Attorney's Office shall review cases from a criminal aspect for possible prosecution.

While these are separate responsibilities and perspectives, it is critical to the successful resolution of both the legal and social ramifications of a case that investigations proceed jointly and with total cooperation.

Unique circumstances shall allow for one agency to proceed without the presence of a representative of the other agency. For example, if the alleged victim lives in another state and there are no other potential victims in the home, the CCSO could proceed with their investigation after proper notification to the DSS, Child Protective Services (CPS).

#### 3-163.1 DEFINITIONS

The following terms are defined as they may appear in the context of the Memorandum of Agreement and/or within this policy:

**Charles County School Personnel or Designee** - an individual employed by the Charles County Public School system who acts as a supportive advocate of a child during the interview process.

**Child Protective Service Worker** - a social worker / case manager employed by the Charles County Department of Social Services and assigned to the Child Protective Services Unit. These social workers / case managers have received specialized training in the issues concerning physically abusing, sexually abusing and/or neglecting families.

**Child Abuse Investigator / Detective** - a police investigator who has received special training in the field of child abuse. A police officer who is specially assigned to work child abuse cases to the exclusion of other criminal investigations.

**Child Care Regional Manager / Child Care Licensing Supervisor / Child Care Licensing Specialist** - an individual employed by the Maryland State Department of Education (MSDE), Office of Child Care, Region 10, who



## Administrative and Operational Manual

September 12, 2022

is responsible for the registration and licensing of family child care homes and child care centers respectively, and for ensuring the health, safety and welfare of children in their care.

**County Attorney** - the office of the County Attorney is responsible for all legal affairs, as required by Maryland Code, of the County Government, including the Department of Social Services and Charles County Sheriff's Office.

**Criminal Investigator / Detective** - an officer assigned to the criminal investigation division of a law enforcement agency.

**Police Officer** - a uniformed police officer assigned to general police work.

**State's Attorney** – an attorney who represents the citizens of Charles County in the circuit and district courts in all aspects of criminal prosecutions and in the collection of child support.

### 3-163.2 NOTIFICATIONS

Immediately upon receipt of a report or information concerning a suspected child abuse case, the Charles County Department of Social Services, Child Protective Services Unit shall contact the Charles County Sheriff's Office. The Child Protective Services (CPS) Unit shall attempt to reach the Criminal Investigations Division (CID) by phone and shall also fax a copy of the report to CID. If unable to reach a member of CID by phone, CPS shall telephone the main number of the Sheriff's Office and provide as much of the following information as is available at that time:

- name and age of the abused child;
- street address, directions to the address, and telephone number of the abused child;
- identity of the suspected abuser, street address and directions to the address of the suspected abuser;
- name, street address, directions to the address, and telephone number of the child's parents, guardians or custodians; and
- nature of the suspected abuse.

If the Charles County Sheriff's Office receives a report of suspected child abuse, the Agency shall immediately contact the CPS Unit. During non-business hours, contact will be made by way of a prepared schedule of extended-hour staff provided by the DSS. The Sheriff's Officer making the notification shall provide as much of the following information as is available at that time:

- name and age of the alleged abused child;
- street address, directions to the address, and telephone number of the alleged abused child;
- identity of the suspected abuser, street address and directions to the address of the suspected abuser;
- name, street address, directions to the address, and telephone number of the alleged abused child's parents, guardians or custodians; and
- nature of the suspected abuse.

Additionally, a Child Care Licensing Specialist or Board of Education Liaison shall be included in the notification process as appropriate.

### 3-163.3 INVESTIGATIVE PROCEDURES

Once notification procedures have been followed, a detective and the CPS worker shall make arrangements to meet. In all cases of child physical or sexual abuse, CCSO detectives shall be responsible for all aspects of the criminal investigation. The Child Protective Service worker shall not interfere in the criminal investigation. Neither shall the detective interfere in social work matters, such as child placement or removal. The CPS worker shall be responsible for determining risk and safety to the child, family service needs, and/or risk and safety to other children.

The detective and the CPS worker shall agree on a case-by-case basis who should be the primary interviewer. Whenever possible, the interview of an alleged victim shall be conducted in a familiar setting and out of the presence



Administrative and Operational Manual

September 12, 2022

of the alleged abuser. The determination as to the primary interviewer shall be made considering the following factors:

- individual agency representative's skill with a particular age group;
- assessment of the probable criminal aspect of the case based on the referral information; and
- assessment of any probable reoccurrence of allegations based on the referral information.

If there is disparity between the detective and the CPS worker over who should conduct the interview, the detective shall proceed first. However, the CPS worker shall be allowed to be present during the entire interview. If requested by the detective, the CPS worker shall not participate in the questioning during the initial phase of the interview. After the detective completes the initial phase, the CPS worker shall be permitted to ask additional questions. The detective shall be present during this follow-up interview.

During the initial interview with the alleged victim, as well as interviews with other children possibly involved, a precursory examination to determine if there are any physical injuries should be conducted.

If both the detective and the CPS worker deem it necessary, either agency's representative may agree to be excluded from an interview. If this occurs, immediately upon completion, the individual who conducted the interview shall inform the other of the substance of all statements made. Because of the need to coordinate investigations, exclusion of an agency's representative should rarely occur.

### **3-163.4 SPECIAL INVESTIGATIVE PROCEDURES - THE CHARLES COUNTY PUBLIC SCHOOLS**

If the interview of an alleged victim occurs at a school, school personnel shall be required to provide a private room in which to conduct interviews. Unless the detective and/or the CPS worker reason that it would be detrimental to the investigation, a school representative will be present during interviews in order to reduce the anxiety of the alleged victim. Only one school representative shall be allowed to be present during the interview. The representative will not take an active role in the investigation unless requested to do so.

If, after the initial investigation, the CPS worker deems it necessary to remove the alleged victim from school, the CPS worker will leave a document with the school administrator that includes the name of the alleged victim being removed, the date, time, and signature of the CPS worker.

Notification to the parent or legal guardian of any alleged victim removed from school shall be made by the CPS worker or the detective by the end of the normal school day.

A Charles County Public Schools (CCPS) designated representative will normally be present during the interview of an alleged victim when the alleged abuser is being accused in his / her professional capacity as a CCPS employee. In cases involving school personnel, the CCPS has a responsibility to provide services to the alleged victim or family separate from the criminal or child in danger determinations. Therefore, the substance of all pertinent information shall be shared with the school representative.

### **3-163.5 SPECIAL INVESTIGATION PROCEDURES - CHILD CARE HOMES / CENTERS**

Unless the alleged victim(s) are in immediate danger or team members (detective, CPS worker and the Child Care Licensing Specialist) are unavailable, when a report involves alleged abuse at a registered family child care home, licensed child care center, or a facility operating with a Letter of Compliance, a meeting of the team or a conference call shall occur prior to any action. If a team meeting or conference call does occur prior to the initial interview, the

team shall determine what information needs to be obtained. As appropriate, other issues to be addressed shall include:



Administrative and Operational Manual

September 12, 2022

- the process for interviewing other children who are attending or have attended the home / group child care center;
- notification of parents or legal guardians of children who are attending or have attended the home / group child care center;
- notification to the child care licensee that an investigation is underway;
- possible closure of the child care home / center;
- charging of a suspect or suspects;
- response to media; and
- interviewing of the child care home / center staff (past and present).

If in the course of any visit, the CPS worker or detective perceives that the children are in immediate danger, the CPS worker shall take the necessary actions to protect the children, including their immediate removal. The Office of Child Care, Regional Manager, as the head of the licensing agency, shall be notified of the danger immediately, and shall assist, as necessary, in making arrangements for return of the children to their parents or legal guardians. The day care licensee shall also be notified of any actions being taken to remove the children from danger. The CPS worker, according to the agreement by the team, shall make notifications.

If, as a result of the initial visit, the CPS worker or the detective finds children are not in immediate danger, the Child Care Licensing Supervisor or Regional Manager and the other members of the team shall be advised of that assessment.

If notification of the investigation has not been given to the child care licensee as part of an emergency removal of children, the team shall determine which member of the team will notify the child care licensee and when such notification can be made without interfering with any pending investigation. The parent of any alleged victim(s) may be notified prior to the notification of a licensee.

When the team determines it is necessary, a representative of the MSDE, Office of Child Care shall be permitted to observe the joint interview in an effort to decrease any trauma experienced by the alleged victim. Prior to the ending of an interview session, the interviewer shall allow the MSDE, OCC representative to address any questions not previously covered.

Members, as determined by the team, shall conduct interviews with the parents of the alleged victim, other children attending the child care home / center and child care staff jointly.

When investigators have determined the investigation will not be impeded, appropriate members of the MSDE, OCC licensing staff shall be allowed to make an inspection of the child care home / center to assess policies and actions which may have contributed to the alleged abuse.

The team shall take preventive action as necessary and appropriate. They shall document any violation of licensing regulations observed, prepare a plan to correct any irregularities and address potential disciplinary action. When an emergency suspension is warranted, the Office of Child Care will evoke any emergency section of Maryland Code necessary and subsequently notify the team.

In order to attempt to assess the extent and scope of the alleged abuse, when appropriate, a member of the investigative team will notify the parents of other children in the child care home / center the investigation is underway and may seek their assistance in any way deemed appropriate.

If the team determines the best approach to notifying parents is a general meeting, it shall be conducted and attended by appropriate members of the team. Only parents or legal guardians of children presently enrolled or previously enrolled at the home / center shall be allowed at the meeting. The purpose of a general meeting of parents shall be to:

- seek parental assistance in identifying other children who may have been abused;



**Administrative and Operational Manual**

**September 12, 2022**

---

- educate parents on the physical and behavioral indicators of child abuse;
- explain the procedures for investigating reports of suspected abuse; and
- inform parents of the procedures for contacting the appropriate team member if they believe a child has been abused or wish to provide information regarding the center.

Upon completion of the child abuse investigations and at other appropriate intervals determined by the team members, there shall be a case staff meeting. The participants shall discuss the findings of the investigation, follow-up actions to be taken by each of the agencies, and any corrective action to be taken on the part of the licensee.

### **3-163.6 DISPOSITION**

The Charles County Department of Social Services shall promptly provide the State's Attorney for Charles County with one copy of all disposition reports. They shall also forward one copy to the CCSO or other appropriate law enforcement agency.

The CCSO shall provide to the Charles County Department of Social Services a report on all alleged abuse cases within ten (10) hours of its initial investigation, and shall, upon request, provide a copy of all interim and final reports as they are completed.





## Administrative and Operational Manual

September 12, 2022

### 3-164 MEMORANDUM OF UNDERSTANDING - MARYLAND TRANSPORTATION AUTHORITY POLICE

A Memorandum of Understanding has been entered into between the Sheriff of Charles County and the Maryland Transportation Authority (MdTA) Police Force. The MOU outlines the authority and responsibilities of each agency regarding the provision of law enforcement services in Charles County Maryland. Nothing in the MOU shall be construed to limit the authority provided to either party under the Maryland Annotated Code or other applicable law.

#### 3-164.1 GENERAL REQUIREMENTS

The Charles County Sheriff's Office is responsible for providing law enforcement services for the preservation of the public peace, prevention of crime, protection of property and the rights of persons and enforcement of laws in Charles County.

MdTA Police Officers have all the powers granted to peace officers or police officers of this state, but may exercise those powers only on property owned, leased or operated by or under the control of the Maryland Transportation Authority, the Maryland Aviation Authority, the Maryland Port Authority and specifically at the Harry W. Nice Bridge located in Charles County.

MdTA Police Officers may not exercise police powers on any other property unless:

- engaged in fresh pursuit of a suspected offender;
- specifically requested or permitted to do so in a political subdivision by its chief executive officer or its chief police officer; or
- ordered to do so by the Governor.

#### 3-164.2 CALLS FOR SERVICE ON MARYLAND TRANSPORTATION AUTHORITY PROPERTIES

MdTA Police shall have primary responsibility for all requests for police services, enforcement of traffic laws, investigation of all traffic accidents and investigation of all crimes on all MdTA properties.

The MdTA Police is the primary agency responsible for conducting follow-up investigations of all incidents occurring on MdTA Police properties. Members of the Sheriff's Office agree to assist MdTA Police personnel in follow-up investigations upon request to the Sheriff's Office.

#### 3-164.3 CONCURRENT LAW ENFORCEMENT JURISDICTION

Under the MOU the MdTA Police are further authorized to exercise concurrent law enforcement jurisdiction in Charles County, specifically as follows:

- Route 301 from the Harry W. Nice Toll Plaza, M22 to Route 257, 1.4 miles north of the Bridge; and
- the property on which the Charles County Tourist Information Center (Crain Memorial Welcome Center) is located at 12480 Crain Highway, Newburg, Maryland 20644.

The MdTA Police agree to be responsible for routine patrol of and emergency response to the Tourist Information Center. Regarding this location they agree to:

- provide the first response to an incident;
- conduct a preliminary investigation; and
- secure the scene pending the arrival of the Sheriff's Office.



**Administrative and Operational Manual**

**September 12, 2022**

Understanding that emergencies at the Harry W. Nice Memorial Bridge take precedence, if the MdTA Police are unable to respond to an incident at the Tourist Center, they will immediately contact the Sheriff's Office which will assume responsibility for the Center and will be primary on follow-up investigations.

It is agreed that in the specified areas of concurrent jurisdiction that the first agency at the scene of any incident shall provide the law enforcement services necessary. However, the Sheriff's Office shall have primary authority to direct, control and coordinate the investigation of all Part I offenses, specifically:

- criminal homicide (murder, voluntary and involuntary manslaughter);
- vehicular manslaughter (except those cases that originate from traffic fatalities investigated by the MdTA Police);
- rape;
- robbery;
- aggravated assault;
- burglary;
- breaking and entering;
- theft;
- auto theft; and
- all other crimes of violence as cited in the Maryland Annotated Code.

The MdTA Police will immediately notify the Sheriff's Office if they are the first summoned to any such crime scene.

**3-164.4 POINT OF CONTACT**

The point of contact between the agencies shall be the Commander, South Patrol Division for the Sheriff's Office and the Commander at Harry W. Nice Bridge for the MdTA Police.

**3-164.5 LIABILITY**

Each of the parties to the MOU agrees to indemnify and save harmless the other party against any and all claims by third parties for property damage or personal injury arising from each party's respective activities performed under the MOU and agrees to waive any and all claims against the other party which may arise out of the activities performed under the MOU. Each party shall remain liable for the acts or omissions of its own employees to the extent permitted by applicable law. Nothing in the MOU shall be construed to waive any immunities or privileges afforded by law.



Administrative and Operational Manual

September 12, 2022

### 3-165 MEMORANDUM OF AGREEMENT - JOINT INVESTIGATIVE PROCEDURES OF VULNERABLE ADULTS

The Charles County Sheriff's Office (CCSO), Charles County Department of Social Services (DSS), the Area Agency on Aging, the Charles County State's Attorney's Office (SAO), and the Maryland State Police (MSP), have entered into an agreement for the purpose of enhancing and promoting a professional working relationship between the involved agencies to improve the quality of life of vulnerable adults in Charles County. This policy outlines the expectations and involvement of the Charles County Sheriff's Office and the Charles County Department of Social Services in accordance with this agreement as the two agencies primarily responsible for these investigations.

#### 3-165.1 DEFINITIONS

The following terms are defined as they may appear in the context of this policy:

**Abuse** - the sustaining of any physical pain or injury by a vulnerable adult as a result of cruel or inhumane treatment or as a result of a malicious act by a care giver, a parent or other person who has permanent or temporary care or custody or responsibility for the supervision of a vulnerable adult, or by any household or family member under circumstances that indicate that the vulnerable adult's health or welfare is harmed or threatened.

**Adult Protective Service Worker** - a social worker employed by the Charles County Department of Social Services and assigned to the Adult Service Unit.

**Adult** - a person eighteen years of age or older.

**Care giver** - a person under a duty to care for a vulnerable adult.

**Crime** - any act or omission that is in violation of public law which includes but is not limited to: assault, robbery, rape and related sex offenses, theft and embezzlement.

**Criminal Investigator** - an officer assigned to the Criminal Investigations Division of a law enforcement agency.

**Emergency** - conditions which present a substantial risk of death or immediate and serious physical harm to a person (self or others).

**Exploitation** - any action which involves the misuse of a vulnerable adult's funds, property or person.

**Law Enforcement Agency** - any state, county or municipal police department, bureau or agency.

**Local State's Attorney** - means the State's Attorney for the County, either:

- where the vulnerable adult lives; or
- where the abuse is alleged to have taken place.

**Neglect** - the willful deprivation of adequate food, clothing, essential medical treatment or rehabilitative therapy, shelter or supervision, to a vulnerable adult.

**Patrol Officer** - a uniformed police officer assigned to general police duties.

**Self-neglect** - the inability of a vulnerable adult to provide himself the services:

- necessary for his physical and mental health; and
- the absence of which impairs or threatens his well-being.

**Vulnerable Adult** - an adult who lacks the physical or mental capacity to provide for his daily needs.



Administrative and Operational Manual

September 12, 2022

### 3-165.2 RESPONSIBILITIES - CHARLES COUNTY SHERIFF'S OFFICE

Upon receiving a report that a vulnerable adult has been abused, neglected or exploited, the CCSO will at a minimum, document this on a Charles County Sheriff's Office Offense / Incident Report Form #20. Further, the DSS will be contacted by the most expeditious means available and provided with:

- the name, age and home address of the vulnerable adult;
- the name and home address of the person responsible for the care of the vulnerable adult;
- the whereabouts of the vulnerable adult;
- the nature of the vulnerable adult's incapacity;
- the nature and extent of the abuse, neglect or exploitation of the vulnerable adult including any available information regarding previous injuries resulting from abuse, neglect, self-neglect or exploitation; and
- any other information which would be helpful in determining:
  - the cause of the suspected abuse, neglect, self-neglect or exploitation; and
  - the identity of any individual responsible for the abuse, neglect, self-neglect or exploitation;
  - the urgency of the situation.

Upon receiving a report from DSS indicating the possibility a crime has been committed against a vulnerable adult, a representative of the CCSO Criminal Investigations Division will promptly notify the DSS worker making the report:

- whether or not a criminal investigation will be conducted; and
- the name and location of the detective who will be conducting the investigation if one is necessary.

Upon receipt of a request from DSS for investigative assistance, the CCSO will provide a uniformed law enforcement presence when:

- there is indication from the initial report to the DSS that conditions are such that the safety and well-being of the DSS representative would be jeopardized if not accompanied by a uniformed police officer;
- the DSS representative believes an emergency exists regarding the condition of a vulnerable adult, and should the officer agree that an emergency exists, he shall ensure the vulnerable adult is transported to an appropriate health care facility;
- during an investigation, the DSS representative is refused entrance into the vulnerable adult's residence or cannot for some other reason enter the residence and there is probable cause to believe the vulnerable adult is in danger as a result of abuse, neglect, self-neglect or exploitation; or
- at any time during the course of an investigation the DSS representative deems it necessary to request investigative assistance or law enforcement presence.

As appropriate, a local or State Area Agency on Aging may assist in the investigation. Adult Evaluation and Review Services (Health Department) shall provide an evaluation for any vulnerable adult at risk for nursing home placement for whom a request is made by Adult Protective Services for a biopsychosocial assessment.

### 3-165.3 RESPONSIBILITIES - CHARLES COUNTY DEPARTMENT OF SOCIAL SERVICES

The Charles County DSS is responsible for providing twenty-four hour coverage for receiving and investigating complaints of abuse, neglect and/or exploitation of vulnerable adults. Should the DSS investigation indicate the possibility a crime has been committed against the vulnerable adult, immediate notification will be made to the CCSO Criminal Investigations Division. Included in this notification when available will be:



**Administrative and Operational Manual**

**September 12, 2022**

---

- the date and time the report was received by the DSS;
- name and age of the vulnerable adult;
- address, telephone number and directions to the residence of the vulnerable adult;
- nature, date and location of the crime committed against the vulnerable adult;
- name, address and directions to the residence of any suspect(s);
- names, addresses and telephone numbers of any possible witnesses; and
- any other information deemed relevant to the situation.

The responsibilities of the Charles County DSS do not extend to:

- the abuse of a patient in a mental health facility;
- the abuse of a patient in a facility for mentally retarded individuals;
- the abuse of a patient in a nursing home; or
- the abuse of a patient in a hospital.

The primary responsibility for investigating reports of abuse of adults in such facilities is that of the Department of Health and Mental Hygiene, Office of Licensing and Certification.



Administrative and Operational Manual

September 12, 2022

---

**3-166 MEMORANDUM OF UNDERSTANDING (MOU) WITH THE MARYLAND DEPARTMENT OF NATURAL RESOURCES**

A Memorandum of Understanding has been signed between the Charles County Sheriff's Office and the Maryland Department of Natural Resources establishing concurrent jurisdiction over property adjoining state-owned property which is managed by the Department of Natural Resources. This MOU establishes the authority of persons commissioned as Forest, Park and Wildlife Rangers to enforce Civil and Criminal Laws on all public and private property within Charles County which adjoins the boundaries of:

- Smallwood State Park;
- Mattawoman Natural Resource Management Area;
- Cedarville State Forest;
- Chapel Point State Park;
- Doncaster State Forest;
- Purse State Park; and
- Myrtle Grove Wildlife Management Area.

This MOU places no additional duties or responsibilities on members of the Charles County Sheriff's Office, nor does it in any way diminish or relinquish the law enforcement authority of the Charles County Sheriff.



## Administrative and Operational Manual

September 12, 2022

### **3-167 INTERAGENCY AGREEMENT BETWEEN THE MARYLAND DIVISION OF PAROLE AND PROBATION AND THE SHERIFF OF CHARLES COUNTY**

Recognizing that the Maryland Division of Parole and Probation and the Charles County Sheriff's Office have a mutual interest in creating safe communities by sharing information regarding offenders who have been convicted of crimes listed in Criminal Law Article, § 14-101 of the Annotated Code of Maryland (Crimes of Violence), the two Agencies have entered into an agreement in furtherance of that interest. The following policy explains the responsibilities of each Agency pursuant to this agreement.

#### **3-167.1 RESPONSIBILITIES - DIVISION OF PAROLE AND PROBATION**

The Division of Parole and Probation will provide on a quarterly basis, a listing of all offenders being supervised on parole or probation for crimes of violence in Charles County. The list will contain the:

- offender's name;
- supervising agent's name;
- current case status / level of supervision; and
- personal identifying information of the offender, including:
  - home address;
  - date of birth;
  - sex and race; and
  - FBI and SID numbers.

#### **3-167.2 RESPONSIBILITIES - CHARLES COUNTY SHERIFF'S OFFICE**

The Charles County Sheriff's Office will provide a camera in good working order and film to allow Division of Parole and Probation personnel to photograph all active violent crime offenders. The photograph will be taken when the offender reports for intake procedures or is transferred to the Charles County office for supervision from another Division of Parole and Probation office. The photograph may be updated if the offender's appearance changes significantly while under supervision.

The offender's photograph will then become part of the Parole and Probation case file, but will be made available (loaned), to the Charles County Sheriff's Office for official criminal investigation purposes.

Both receipt of the offenders' list, and supply of the camera and film will be the responsibility of the Investigations Section, Criminal Investigations Division of the Charles County Sheriff's Office.



**Administrative and Operational Manual**

**September 12, 2022**

---

**3-168      AGREEMENT BETWEEN THE UNITED STATES DEPARTMENT OF THE  
INTERIOR AND THE STATE OF MARYLAND**

In 1996 an agreement was signed between the Secretary of the United States Department of the Interior and the Governor of the State of Maryland. As a result, concurrent jurisdiction was established over a number of park areas in Maryland which were under the exclusive or proprietary jurisdiction of the National Park Service, and therefore the United States Park Police. Included in these parks were two in Charles County: Piscataway Park and the Thomas Stone National Historic Site. The effect of this agreement is that the Charles County Sheriff's Office now has full authority to enforce all laws, criminal and civil, on these lands just as on any other public or private property within Charles County.





## Administrative and Operational Manual

September 12, 2022

### 3-169 MUTUAL AID AGREEMENT – PRINCE GEORGE'S COUNTY POLICE DEPARTMENT

Recognizing it is in the public interest that law enforcement agencies throughout the State of Maryland cooperate to the greatest extent possible to provide prompt, effective, and professional law enforcement services, this Agency has entered into a mutual aid agreement with the stated county's law enforcement agency. It is considered to be in the best interests of the citizens of the said counties for the counties to assist with emergency calls and provide for the exchange of patrol assistance across county lines for police service in order to enforce the laws and to protect persons and property in the adjoining boundary areas.

#### 3-169.1 CONDITIONS FOR INTERDEPARTMENTAL TRANSFER OF PERSONNEL

When the determination is made by a requesting jurisdiction that there is a need for assistance which cannot be met through use of its own patrol personnel, the requesting jurisdiction may then request patrol personnel from the assisting jurisdiction.

Requests will be exchanged between the respective Communications Sections. The request for assistance shall state:

- The reason and location for the patrol response; and
- The number of patrol officers requested.

All calls for assistance received from Prince George's County shall be cleared by Communications through an on-duty commander prior to any police response. The commander will approve or deny the request based on manpower availability. The commander shall notify the respective shift supervisor upon approval of request. On calls of a serious nature, all efforts will be made to accommodate requests. Approved calls will generally, but not exclusively, be limited to the following:

- Signal 13 - officer needs assistance;
- Natural disasters;
- Large fights with weapons involved;
- Hostage / barricades;
- Riots; and
- Other serious calls requiring manpower on a short-term basis.

All officers responding will acknowledge and advise Communications. Approximate response time will be communicated to Prince George's County.

Unless life threatening or other exigent circumstances exist, Charles County Sheriff's officers will attempt to await the arrival of a Prince George's County unit prior to taking action.

The assisting patrol officers shall be used to respond to emergency calls for service as a backup unit for the minimum time necessary to handle the call for service.

Charles County Sheriff's officers shall not assume command of any situation or incident. Whenever possible, they shall be responsible to a single supervisor. If this is not possible, the ranking officer from Prince George's County shall determine how supervision is to be arranged.

The assisting officer(s) shall not become involved in matters other than those pertaining to call for service for which requested.



Administrative and Operational Manual

September 12, 2022

Assisting officer(s) shall have the use of deadly force only in defense against an attack that may result in death or serious bodily injury to the officer, innocent bystanders or other officers on the scene.

The assisting patrol officer(s) shall serve at the discretion of the requesting jurisdiction. The assisting jurisdiction may unilaterally withdraw its personnel at any time after notifying the requesting jurisdiction of such action.

Should an unusual or major incident involving Charles County Sheriff's officer(s) occur, the shift supervisor shall respond to the scene.

Charles County Sheriff's officers shall return to service immediately upon being released by the officer in charge. Returning officers shall notify Communications when re-entering Charles County.

### 3-169.2 RESPONSIBILITIES - RESPONDING OFFICERS

Prior to securing from duty, assisting officers will complete a Commanders' Information Report detailing the circumstances of the incident. Officers who are in a neighboring jurisdiction because of this agreement have all the immunities from liability and exemption from laws, ordinances and regulations, and have all pensions, relief, disability, workers' compensation and other benefits enjoyed within the jurisdictional limits of the Charles County Sheriff's Office.

### 3-170 BLUE RIBBON PROJECT – BACKPACKS OF LOVE

In an effort to improve the quality of life for children who have been the victims of child neglect and abuse, the Charles County Sheriff's Office has partnered with the La Plata Police Department, the Blue Ribbon Project-Backpacks of Love, the Charles County Department of Social Services, and the Charles County Foster Parents Association to provide needed supplies to children placed in foster care.

#### 3-170.1 NOTIFICATION

When a child is placed in foster care in Charles County, it is the responsibility of the Department of Social Services (DSS) employee to notify Communications of the need for a backpack delivery. The following information will be provided:

- The location of the child.
- The sex and age of the child.
- A callback number.
- The name and a contact number for the DSS employee.

#### 3-170.2 DELIVERY

If the location of the child is within the corporate limits of La Plata, a LPPD officer shall obtain the age appropriate backpack and shall arrange for delivery as soon as practical. If the location of the child is outside the corporate limits of La Plata, a Charles County Sheriff's officer will respond to the LPPD Headquarters and meet with a LPPD employee in order to obtain the age appropriate backpack. The Charles County Sheriff's Officer will then deliver the backpack to the child at the dispatched location.

**NOTE:** If either agency's workload prevents the timely delivery of the backpack, nothing prohibits the allied partner



**Administrative and Operational Manual**

**September 12, 2022**

---

from delivering the needed items in the other's primary jurisdiction.

**3-170.3 STORAGE OF BACKPACKS**

It is the responsibility of the La Plata Police Department to store the backpacks and provide access to the backpacks to members of the Charles County Sheriff's Office.

**3-170.4 NOTIFICATION OF DELIVERY**

When an officer delivers a backpack, a memorandum or email will be forwarded through the chain of command to the La Plata Chief of Police. The notification process is essential not only for replenishment purposes, but to track the success of the program.



Administrative and Operational Manual

September 12, 2022

---

### 3-176 SPECIAL ACCESS TO PRIVATE PROPERTY AND PUBLIC BUILDINGS

Employees are trusted with the ability to access certain private properties and public buildings when exigent circumstances exist or the property owner has provided a method to allow law enforcement access when properties are vacant, closed to the public, or access is restricted. The duplication of any form of access is prohibited as is any action that would allow for future unauthorized entry.

The Charles County Government and Charles County Public Schools have granted access to sworn employees to their facilities in the event of an emergency or life threatening situation. Access is for official law enforcement purposes only and shall be reported to Communications. Communications will generate a call-for-service to document the reason for entry.

If entry is made as a result of a covert operation or there is a legitimate operational need to keep this action confidential, the division commander will be notified immediately. This policy is not intended to prohibit an employee entry to any property or possession he has a personal legal right to or that is part of their everyday duties.

No private property or public property shall be used for training or other purposes sanctioned by the Sheriff's Office without the approval of a division commander and the private property owner/legal representative or an authorized agent for the accessed public property. Unsanctioned activities are strictly prohibited.

**Administrative and Operational Manual**

September 12, 2022

**3-200 RECORDS SECTION****3-200.1 GENERAL RESPONSIBILITIES**

Public interest and individual privacy are directly affected by the collection, maintenance, and dissemination of police information. In the interest of criminal justice, policies, procedures, and guidelines are established for:

- Disseminating criminal history record information;
- Releasing victim information;
- Disclosing juvenile information;
- Purging information / complying with court ordered information disclosures;
- Maintaining records control for the collection, maintenance, dissemination, and disposition of police records;
- Collecting fees for police reports.

**3-201 PURPOSE OF REPORTS**

Recorded information protects the Agency and personnel handling police transactions from unwarranted accusations that improper or inadequate police actions were taken.

**3-202 RECORDS CONTROL****3-202.1 RECORDS COLLECTION**

The Records Management Section shall be the official Central Records Repository for the following police records:

- Crash reports
- Offense / Incident reports
- Criminal records
- Expungement records
- Identification records
- Juvenile records
- Property records
- Traffic records

**3-203 RECORDS REVIEW**

Personnel assigned to the Records Management Section shall review and process police reports mainly for:

- Accuracy
- Completeness
- Legibility
- Distribution
- Accountability
- Juvenile confidentiality
- Privacy-security-access
- Other reporting deficiencies

**3-204 FEE SCHEDULES**



**Administrative and Operational Manual**

**September 12, 2022**

The Deputy Director, Records Management will develop, maintain, and publish a fee schedule for reports and photographs. All such fee schedules and any subsequent changes will be directed to the Sheriff for approval.

**3-208 RECORD RETENTION**

The policy of the Sheriff's Office is to maintain records in a manner which allows the Agency to fulfill its legal duties. Records will be kept at all levels of the organization by adherence to the rules and guidelines contained within this Manual and within the Standard Operating Procedures developed in writing for individual units. This task may be accomplished by:

- Creating only those records necessary for the operational and administrative functions of the Agency; and by
- Storing records in the most economical manner which provides the level of access needed to make the information useful and meet the operational and administrative needs of the Agency; and by
- Disposing of records which no longer serve a useful function for the Agency.

**3-208.1 RECORDS MAINTENANCE AND DISPOSAL**

The following specific records maintenance and disposal procedures have been established and will be adhered to unless specific authorization has been obtained in writing from the Sheriff.

**Applicant Files:**

- Applicant files will be maintained Human Resources for a period of four (4) years;
- Applicant files of successful applicants will become a part of the employee's Background file on their date of hire;

Applications of applicants not selected for Background will be retained for one (1) year; applicant files which have been in the Background process will be retained for four (4) years.

**3-209 CONFIDENTIALITY RULES**

All police records, with the exception of traffic related records, are subject to local, state, and federal privacy laws. Police personnel shall not engage in dissemination practices. All report dissemination will originate from the Records Section.

**3-210 REPORT/PHOTOGRAPH REQUEST FORMS**

Citizens wishing to obtain copies of crash reports or Offense / Incident Reports must make the request to the Records Section. This request must be made by utilizing the Multiple Request Form #331 available at Headquarters or any district station, at a fee of \$8.00 per report.

All requests for photographs shall be directed to the Records Section at Headquarters, where a Request for Photographs Form #164 will be completed.

The Records Section shall process all requests in a timely manner and mail the appropriate report(s) to the requesting party, normally within seven (7) to ten (10) working days of the request.



Administrative and Operational Manual

September 12, 2022

### **3-211 CRIMINAL RECORDS INQUIRIES**

Criminal history records information will be disseminated to criminal justice Agencies / persons and/or authorized agencies for:

- Criminal justice investigations;
- Criminal justice Agency employment investigations.

### **3-212 TELEPHONE REQUESTS FOR CRIMINAL HISTORY RECORDS INFORMATION**

Telephone requests for Criminal History information will be forwarded to the Records Management Section for consideration. All other telephone requests must be faxed on an Agency letterhead with requestor information for verification. All non-law enforcement persons will be referred to CJIS, Central Repository in Pikesville, Maryland.

### **3-213 IDENTITY VERIFICATION**

When requesting criminal history records information in person, the requestor must establish his identity by a valid driver's license with a photograph or an identification card. If uncertainty exists concerning the identity of the requestor, fingerprints or some other means of identification may be required.

### **3-214 DISCLOSABLE CRIMINAL HISTORY RECORDS INFORMATION**

The following police documents may be disseminated to authorized Agencies / persons for law enforcement purposes only:

- Arrest reports
- Disposition sheets
- Criminal photographs (mugs)
- Fingerprints
- Latent fingerprints

Whenever criminal information and/or photographs are given out, a notation must be placed on the inside front file folder stating the date, person to whom information was given, their Agency and the name of person who gave the information.

### **3-215 POLICE REPORTS - AUTHORIZED PERSONS / AGENCIES**

Except for portions of reports subject to confidentiality, information contained in police reports may be released to the following "interested" persons:

- Owners (real / personal property)
- Complainants (T/A)
- Victims (real / personal property)
- Authorized representatives
- Aggrieved individuals
- Parents / legal guardians



**Administrative and Operational Manual**

**September 12, 2022**

- Insurance companies
- Criminal Justice agencies (local, state, and federal)

### **3-216 APPEAL PROCEDURES**

If the requested information is withheld, concerned individuals may appeal to the appropriate court for a court ordered disclosure.

### **3-217 JUVENILE RECORDS**

#### **3-217.1 DISCLOSABLE RECORDS**

The following juvenile related records may be disclosed to law enforcement agencies / persons for investigative purposes:

- Juvenile Field Reports
- Arrest Reports
- Photographs
- Fingerprints
- Civil Offense Citations
- Incident Reports
- Juvenile Citations

#### **3-217.2 DISCLOSURE PROCEDURES**

Juvenile History Records Information (JHRI) is releasable to criminal justice agencies / persons for specified purposes:

- Criminal Investigations
- Court Orders
- Arrest Information
- Contact Information (FIR)
- Traffic Violations

#### **3-217.3 RECORDS REVIEW BY RESPONDENTS**

Juvenile offenders may review their records if authorized by court order.

#### **3-217.4 JUVENILE DISPOSITION INFORMATION REQUESTS**

Requests for juvenile disposition information will be referred to the Department of Juvenile Services, located in the Charles County Courthouse, La Plata, Maryland.





## Administrative and Operational Manual

September 12, 2022

### 3-217.5 AUTHORIZED JHRI RECIPIENTS

The following are authorized to receive arrest and non-arrest juvenile information:

- Department of Juvenile Services
- Law enforcement agencies
- Persons or organizations authorized by court order

### 3-217.6 SANCTIONS FOR UNAUTHORIZED DISCLOSURES

Improper dissemination of juvenile information to unauthorized agencies or persons may result in:

- Agency administrative disciplinary action
- Civil suits

### 3-218 EXPUNGEMENT OF RECORDS

Employees receiving requests for expungement procedure information shall refer the requestor to the Clerk of the appropriate court of jurisdiction (District or Circuit), where the requestor may file a petition / application for the expungement of records.

The following are subject to expungement rules and procedures:

- Arrest name indices;
- Arrest reports, including paper copies and microfilm;
- Criminal identification indices;
- Criminal Photographs (prints and negatives);
- All fingerprints and handwriting samples;
- Records of detention or confinement.

#### 3-218.1 EXPUNGEMENT PROCEDURES

Criminal records are subject to state expungement regulations. When court-ordered expungement procedures are initiated, records are physically removed from the storage location.

When expungement orders are received from the court, police records are then sealed in envelopes and stored in locked file cabinets, inaccessible to the law enforcement body.

CHRI recipients and petitioners are notified in writing of the expungement order, and compliance thereof.

The Deputy Director, Records Management Section shall:

- Prepare Agency's responses to inquiries;
- Execute the provisions of expungement orders served on the Agency;
- Inform the Sheriff of any such actions.



Administrative and Operational Manual

September 12, 2022

### 3-218.2 EXPUNGEMENT ACCESS GUIDELINES

Expunged records cannot be disclosed, released, disseminated, reviewed, inspected, accessed, or copied without an order from the court of original jurisdiction.

### 3-218.3 EXPUNGEMENT COMPLIANCE REQUIRED

Expungement compliance shall be acknowledged to the appropriate court and petitioner with a "Certification of Compliance" within thirty (30) days of notification by the Deputy Director, Records Management Section.

### 3-218.4 SANCTIONS FOR UNAUTHORIZED DISCLOSURES

The law prohibits the unauthorized disclosure of expunged records. Any employee releasing expunged information is subject to the following penalties:

- Criminal charges;
- Administrative disciplinary action;
- Civil suits.

### 3-220 TRAFFIC RECORDS

Information contained in motor vehicle crash reports shall be released only to the following interested persons:

- Drivers;
- Parents / legal guardians of minor drivers;
- Owners of vehicles or damaged property;
- Persons or agencies who may incur civil liability;
- Attorneys or authorized representatives of any of the above persons;
- Insurance companies.

The following traffic records are maintained by the Records Management Section for internal purposes:

- Summonses / Citations
- Safety Equipment Repair Orders
- Crash reports
- Crash photographs

### 3-221 PHOTOGRAPHIC DOCUMENTATION / EVIDENCE

Photographs of the scene of an event can provide the opportunity for persons not present during the event occurrence to view the scene as it exists shortly after the event occurrence. Photographs can also show evidence as it was found in relationship to the rest of the scene, and before it suffered degradation as a result of time passage. Photographs can help show the view which complainants, victims, witnesses, and investigators had at the time of, or a specific time after the event occurred. Some photographs may even show the event happening, if the picture capturing equipment was set up and running during the event.

Because of these possibilities, photographs may be the best possible evidence to allow valid judgments to be made about all aspects of an event. Given this assumption, it falls to any public safety / law enforcement agency to obtain or create the best possible photographs. These can be invaluable in determining cause, identifying perpetrators,

**Administrative and Operational Manual****September 12, 2022**

locating witnesses, finding victims, and otherwise establishing those things which people can know as a result of seeing something as it existed.

Keeping this in mind, it becomes the duty of those who make or gather photographs to show subject matter in the most real and unaltered manner possible. Once a picture is made or obtained, it must be protected, like any evidence, so that it is not lost, changed, or destroyed before it may accomplish all possible legitimate uses.

### **3-221.1 DIGITAL FORMATS**

The Charles County Sheriff's Office is equipped with various types of digital format cameras. These cameras utilize the capture of data in pixel format instead of the traditional negative print film. Advantages of digital photography include the ability to immediately review photographic information, as well as the reduction of logistical storage through utilization of digital images. The cameras used throughout the Sheriff's Office will utilize secure digital SD cards, each supplying various medium capacity.

All evidentiary photographs taken will remain the property of the Charles County Sheriff's Office. No photos will be taken, printed, downloaded, or distributed for any officer's personal use and/or beyond the scope of an officer's official capacity or duty assignment.

### **3-221.2 DIGITAL AND NEGATIVE PRINT FILM IMAGE INTEGRITY**

The Charles County Sheriff's Office is absolutely committed to ensuring the integrity of all photographic information captured in a digital format. There will be no manipulation or deletion of the photographs, either by the officer who took the photograph or by any member of this Agency.

Each employee who is issued a digital camera will be issued two SD cards. Additional SD cards will be supplied to supervisors. The SD card provides the storage medium to be used to store photographs taken by employees with the digital camera.

The SD cards utilized by each camera will be downloaded at a Digital Image Management System (DIMS) terminal located at each district station and CID. Upon completion of the DIMS download, all recorded images on the SD card will be deleted and the SD card will become available for re-use. The preferred method of downloading is using the DIMS; however, SD cards may be sent directly to the FSS via Agency mail. Those mailed SD cards must be placed in a sealed evidence bag and placed in the photo envelope for delivery. Each SD card will contain the officer's ID number. At no time will evidentiary photographs be altered. All evidentiary photos will be forwarded to the FSS on the medium used to create the image, to be logged and stored. As with all evidence, photos will only be allowed to be distributed outside of the Agency in accordance with current Agency policy.

The Agency authorizes member access to varying types of digital format cameras. Digital cameras aid the department in several different functions. However, only those images that are assigned an Agency Incident Report Number and are classified as evidence will be forwarded and maintained by the FSS. Any storage and/or printing of digital evidence photographs on any computers and/or printers other than the (DIMS) is prohibited.

Storage of negative print film will follow the same basic steps as with digital images. The negative print film will remain on file at the FSS, and print requests of the negatives must be made. In the event it becomes necessary to digitize the negative print film, the storage and control of the images will follow the same procedures as digital images.

No Agency employees, except those assigned to the FSS, will be authorized to store and/or duplicate any photographic digital information that is classified as evidence on any Agency or personal computer / computer

**Administrative and Operational Manual****September 12, 2022**

system without express written permission from the Sheriff or his designee. Additionally, no digital photographs classified as evidence will be stored by and/or transmitted to other individuals. No digital photographs will be posted on the Internet without the express consent of the Sheriff or his designee. Utilization of any method other than the DIMS terminals for transferring digital photographic data (downloading) electronically is also prohibited. The only exception will be the existing procedures and/or future electronic advancements which allow the FSS to transmit data to and from appropriate entities.

**3-221.3 USE OF DIGITAL CAMERAS FOR PHOTOGRAPHING CRIME SCENES**

When conducting investigations for minor offenses and/or limited crime scenes that do not warrant the FSS response, adherence to the following procedure is necessary:

- The digital camera should be set on the Automatic mode for exposure, focus, flash, and the pixel setting should be set at the highest possible quality. The officer will additionally utilize the viewer to review the images and determine the necessity for additional photographs, as needed.
- Photographs should include general crime scene shots to document the location of the incident as well as documenting the appearance of the scene at the time the officer initiated his investigation. Depending upon the nature of the investigation, photographs should be taken of points of entry and exit, other evidence indicating violence, or the presence of physical evidence, etc. When photographing physical evidence requiring close-up range, the officer will stand at a 90-degree angle to the item and place a ruler next to the item to be photographed. This will aid in the ability to print such photographs in the proper size ratios.
- All photographs will automatically store on the camera SD card. No photographs shall be taken unless an SD card is in the camera; otherwise the images will be stored on internal memory which is prohibited. As previously stated, two SD cards will be issued with each camera. Additionally, supervisors will have a supply of SD cards for temporary use by those employees who may need them. If an employee uses both SD cards assigned for a particular camera and has not been able to download them, that employee will obtain another card for immediate use. Under no circumstances will any photos be deleted from the SD cards; all photos will be retained, including those determined to be photographically faulty. Photographically faulted images include, but are not limited to, those that are out of focus, reflect flash detonation failure, display objects blocking the lens, inadvertent pressing of the exposure button, or are blurred due to the movement of the subject or camera.
- All photographs will be downloaded into the DIMS System before the end of the shift. In the event the download is not completed before the end of the shift, a supervisor will be notified and the photographs will be downloaded on the next scheduled work day.
- Information regarding photographs taken at crime scenes shall be recorded in the Incident or Supplement Report. When the digital photographs are downloaded to the DIMS system the I.R. number and officer's ID number will be entered.

**3-221.4 FSS RESPONSIBILITIES AND IMAGE INTEGRITY**

The members assigned to the FSS are ultimately responsible for the storage of photographic information captured and stored as evidence within the Charles County Sheriff's Office, with the exception of mug shots and in-car cameras.

An FSS member will receive all envelopes which contain SD cards or film taken by other members of the Agency. The FSS member will open the photo envelope and remove the sealed bag containing the SD card and record the information. A digital image storage software program will then record the information and store the digital images until required for additional investigation or court appearances.



## Administrative and Operational Manual

September 12, 2022

The images will remain unaltered and documentation will be maintained reflecting the viewing of such photographs or enhancements performed by the FSS member. In the event that the FSS member or investigating personnel determine that enhancement techniques are necessary to adequately present the photograph, documentation of such techniques will be noted to ensure that similar enhancements can be duplicated in court.

When a print request is forwarded to the FSS, an FSS technician will utilize the appropriate file management software to locate the images filed under the requested incident report number. Print requests to the FSS should be made two weeks prior to the date the photographs are needed. However, immediate need will be considered on an individual basis. The contents of these images will be printed and/or placed on a compact disc, and will be forwarded to the requesting officer or State's Attorney's Office. In the event that the images require adjustment for color balance, brightness, or contrast, those adjustments will be noted by the technician.

Once the technician has stored the digital images on the storage software program, the SD card will be erased and returned to the submitting officer.

### 3-221.5 CRASH PHOTOGRAPHS

Photographic negatives are maintained by the Forensic Science Section. Photographs will be printed only upon request. Crash photographs containing grotesque scenes of victims shall not be printed for public distribution.

### 3-221.6 NON-EVIDENTIARY PHOTOGRAPHS

In addition to using photographs to document evidence that is collected, photographs are also used for the identification of people or property and to document certain arrests. Depending upon the purpose of the photograph, there are different applications which allow digital photographs to be uploaded into Agency databases.

#### 3-221.6.1 IDENTIFICATION PHOTOGRAPHS

Photographs are often taken of people or of property for identification purposes. During the conduct of a field interview, in addition to documenting the contact by way of an FIR (field interview report), the officer can document the stop by photographing the person(s), vehicle(s) or any property on the scene. The photographs can then be attached to the electronic FIR in the mobile data software and submitted to the Records Management System. This will allow the photographs to immediately be viewed by other officers and can become an invaluable investigative tool.

#### 3-221.6.2 DIGITAL ARREST PHOTOGRAPHS

During normal processing procedures, photographs known as Mug shots, are taken of people charged with criminal violations. When an arrest is processed at central booking in the Charles County Detention Center, the established procedures for that facility are followed to take the person's Mug shot.

When an arrest is made or a subject is charged with a crime and the person will not be taken to the Detention Center for processing, a digital photograph will be taken and uploaded into the system through a link created for this purpose on the internal Intranet site. Instances when this method would be used would include:

- processing of juveniles;
- serving a criminal summons; or
- certain traffic charges.

### 3-225 GRANT PROCESS

Any development of programs or requests for funding will be coordinated from the start with those components of

**Administrative and Operational Manual****September 12, 2022**

the Agency which will be affected by such funding.

All programs and requests to be funded outside the Agency budget will be fully developed as would any budget request. It is imperative that the Grant Coordinator operate in a support role, and that individual management personnel take the lead role in administration of any grant program.

During the life of the grant, the Grant Coordinator as well as the Deputy Director, Accounting will maintain separate grant files. The Grant Coordinator will keep all original grant application and award documents as well as any grant adjustments and programmatic report documents. The Deputy Director, Accounting will keep all financial related documents as well as financial report documents. The information from both files will be coordinated upon any site monitoring or audits. The Grant Coordinator will send all pertinent programmatic information to the Deputy Director, Accounting to be maintained in the Agency's master file, along with all financial information relating to a particular grant award. A complete file must be maintained by the Accounting Section in order to meet audit and record retention requirements.

A Grant Request Form #960 has been developed to assist the Grant Coordinator in an effort to search for available funding sources. Whenever an employee is seeking grant funding, a Grant Request Form #960 will be completed and forwarded through the chain of command to the Grant Coordinator.

This form will assist in keeping an updated list of items for which the Agency will be requesting grant funds, and will enable the Agency to have project proposals ready when a grant solicitation opens. The form will be kept on file by the Grant Coordinator until the funding is no longer needed.

### **3-225.1 DEVELOPMENT OF GRANT APPLICATION**

A grant application may be the result of an approved Grant Request Form #960 or a request from the Sheriff, Chief of Staff or Assistant Sheriffs, directing the Grant Coordinator to seek a source of funding. A grant application may also be the result of the Grant Coordinator finding funding opportunities. In any case, the first step in the process will be outlining the following, if possible:

- the source of funding;
- the anticipated benefit to the Agency;
- any liabilities associated with acceptance of the grant;
- the time line for the grant process;
- all special conditions;
- allowable and unallowable costs.

The Grant Coordinator will send this outline through the chain of command to the affected Assistant Sheriffs for review. A decision will be made to pursue or abandon the grant. The Grant Coordinator and the affected division commander will be notified of the decision. The Grant Coordinator will, with the input of the identified Agency point of contact for the grant, create the grant application. Once the application is completed, the Grant Coordinator will forward a grant application processing form through the chain of command for the Sheriff's signature. Any application over \$5,000 must also be signed by the Charles County Commissioners. The Grant Coordinator will facilitate this signature process.

The development of any budget and matching funds to be provided by the Agency budget or other County funds will be coordinated through the Budgeting Section.

### **3-225.2 GRANT AWARD PROCEDURES**

When a grant is awarded, the Grant Coordinator will coordinate the development of the grant program in conjunction with the Agency point of contact for the grant. All reports necessary for the administration of the program will be identified. The Deputy Director, Accounting will coordinate all financial reports and financial requirements of the grant in conjunction with the Agency point of contact for the grant.



**Administrative and Operational Manual**

**September 12, 2022**

---

The Agency point of contact will be responsible for all programmatic grant reports and a time line for submission will be developed. The reports will be submitted through the Grant Coordinator. The Coordinator will be responsible for the adequacy of all programmatic reports.

**3-225.3 COMPLETION OF GRANTS**

At the completion of any grant period, the Grant Coordinator will be responsible for seeing that all programmatic requirements of the grant have been met. A final report will be completed with input from the Agency point of contact in order for the grant to be successfully closed out by the funding agency.

The Deputy Director, Accounting will see that all financial requirements have been completed and any accounts associated with the grant have been reconciled as needed.

**Administrative and Operational Manual****September 12, 2022****3-230 AGENCY COMPUTER SYSTEMS**

The CCSO maintains computers and related equipment throughout the Agency. The equipment and the data that the equipment stores and processes are valuable assets of the CCSO. That value is certainly represented by the cost of the equipment. However, sometimes the greater value is in the data which has been gathered. That data may not be replaceable if it were lost, or sometimes the replacement of data may involve many hours of labor and, therefore, much expense.

The data stored in CCSO computer systems and CCSO computer media is the property of the CCSO. Employees of the CCSO do not have an individual right to privacy in such data and should be aware that their computer system, data, and media are subject to inspection by the Sheriff or the Sheriff's designee. Any questions regarding the authority of an individual to inspect an employee's computer system, media, or data should be directed to the Sheriff.

Unauthorized use, removal, or intentional destruction of such data may be considered theft and/or destruction of property. Computer programs developed by Information Technology Division are the property of the Charles County Sheriff's Office. The unauthorized use, removal, or intentional destruction of such programs is theft and/or destruction of property. Persons committing such thefts / destructions are subject to disciplinary and/or criminal sanctions.

**3-230.1 RESPONSIBILITY FOR COMPUTERS AND COMPUTER SYSTEMS**

Each employee of the Agency shall guard against the loss of data stored within the various computers and computer systems operated or accessed by the CCSO. Employees shall take necessary steps to ensure that the computer equipment is properly handled and maintained. The management responsibility for Agency computers, computer systems, data control, and peripheral devices is delegated to the Director, Information Technology Division. The Director shall ensure Agency computers and computer systems meet Agency needs. He shall coordinate the purchase and use of computers in a manner to provide the Agency with the best possible management and processing of information for the resources expended in that regard.

The Director, Information Technology Division is responsible for the provision of documentation and training concerning all computer hardware and software used by personnel of the Agency. The Director, Information Technology Division shall provide, or arrange for the provision of, initial training for each new hardware device or software program installed within the Office of the Sheriff. The Director, Information Technology Division shall provide, as resources allow, each user of computer hardware or software, an instruction manual describing all of the functions and methods of use of each of the hardware devices or software programs available to the employee for use in the performance of the employee's duties.

**3-230.2 COORDINATION OF EFFORT**

The Director, Information Technology Division shall review the budget requests of the various components of the Agency regarding computer equipment and systems. He shall provide information to the various component commanders, directors, and managers to facilitate the acquisition of computer components and sub-systems which are compatible with and enhance the entire Agency system. In this regard, the Director, Information Technology Division shall construct a plan for current and future use of Agency computer equipment and systems. That plan shall be revised and presented with the Information Technology Division budget each year. When approved by the Sheriff, it shall be circulated to the various components of the Agency in order that there might be unity of effort throughout the Agency.

**3-230.3 SYSTEM PURCHASE, INSTALLATION, MAINTENANCE, ETC.**

The Director, Information Technology Division shall coordinate all activities involving computer equipment and computer systems. This includes, but is not limited to, purchasing, installing, training, operation, maintenance, storage, moving, and reconfiguration. It includes both the computer hardware and software. No employee shall engage in these activities without the approval of the Director, Information Technology Division or his designee.



**Administrative and Operational Manual****September 12, 2022****3-230.4 AVAILABILITY OF SERVICE**

The Director, Information Technology Division shall maintain a 24-hour, 7-day / week availability of service, in order to deal with the needs of Agency personnel in these areas of responsibility. The Director shall have the responsibility to coordinate repair services with any vendors outside of the Agency. In this regard, employees shall not contact vendors directly, unless approval to do so is obtained from the Director, Information Technology Division or his designee. The Director shall develop working relationships or contractual arrangements with vendors in order to minimize any down time of equipment due to malfunction or failure.

**3-230.5 SPECIFICS OF HANDLING COMPUTER EQUIPMENT AND SOFTWARE**

No employee shall, without the permission of the Director, Information Technology Division or his designee:

- install any computer or associated equipment;
- install any software program;
- connect or disconnect any computer or associated equipment, except to unplug it from a power source in the event of an emergency;
- move any computer or computer equipment from its place of installation; or
- modify any equipment or software, except to the degree that such modification is a normal user function.

**3-230.6 USE OF PIRATED OR UNLICENSED SOFTWARE**

No employee shall possess, use, install, or permit to be installed, in the course of his employment with the CCSO, a software program which is not licensed to the Agency or the employee. This prohibition applies to all software which is copyrighted, registered, or patented by its owner. This does not apply to software which is "shareware" or otherwise in the public domain, as long as the approval to install that software has been obtained from the Director, Information Technology Division or his designee. Software licenses shall be kept and filed by the Director, Information Technology Division, who shall ensure that all such licenses are registered and/or issued in the name of the CCSO, when the software is purchased with Agency funds. If the software is the property of an individual employee and the employee has been allowed to use the software in conjunction with Agency equipment, a copy of the license, in the employee's name, shall be kept on file by the Director, Information Technology Division.

Any employee who installs software in violation of this policy may be subject to disciplinary action. If the unauthorized software causes the Agency to incur an expense in removing it or repairing damage caused by the software, the employee may be held liable for these expenses.

**3-230.7 MAINTENANCE PROCEDURES**

When there is a problem which prevents a computer or computer system from functioning properly, the problem shall be reported to the Director, Information Technology Division or his designee. If the problem will adversely affect the operation of the Agency component using the equipment, the report may be made via telephone. This will allow Information Technology Division to take immediate steps to correct the problem. Telephone reports of maintenance needs shall be followed up with a Computer Hardware-Software Request Form #49, unless the Information Technology Division employee indicates there is no need for the Form #49.

Whenever a request is made for assistance, concerning Agency computers or computer equipment, the Director, Information Technology Division shall cause to be made a log entry for the request. The Director shall maintain a permanent log for this purpose, with each entry numbered consecutively. The Director shall cause to be placed upon each request for service or assistance, the log number associated with that request. Any associated paper work will be so numbered.

In any case, even if an initial report is made by telephone, the employee making a request for service or assistance shall complete a Hardware-Software Request Form #49, unless specifically relieved of this responsibility by the Information Technology Division personnel. If the employee has been given a number for the request, it will be

**Administrative and Operational Manual****September 12, 2022**

placed in the upper right corner of the form. The request shall be forwarded to the Director, Information Technology Division.

Hardware-Software Request Forms may be submitted directly to the Director, Information Technology Division. A copy of each form shall be forwarded to the submitting employee's division commander, via the employee's chain of command. Hardware-Software Request Forms shall be stocked at all locations where computer equipment is used. The supervisor / manager or designee of the unit using the equipment is responsible for obtaining these forms from the Quartermaster.

### **3-230.8 COMPUTER / SOFTWARE ENHANCEMENTS AND CHANGES**

At any time an employee believes there is a need to change or enhance a particular computer, computer equipment, computer system or software, the employee shall notify the Director, Information Technology Division using the Form #49. The reasons for the change / enhancement should be fully developed on the form or in an associated document. Any needed equipment or software should be fully described, to include:

- general description;
- relationship to current software / hardware;
- time line for implementation; and
- Information Technology Division ID# for current equipment to be enhanced or changed.

The Director, Information Technology Division shall provide assistance to other components of the Agency in developing requests for computer hardware and software. Since the personnel assigned to the Information Technology Division are generally more knowledgeable concerning various software programs and computer hardware, their assistance in the development of Agency requests is invaluable.

### **3-231 OPERATOR CERTIFICATION AND LOGIN ID APPLICATION**

Any employee who must access the Agency computer system in a manner which requires an Agency LOGIN ID number shall complete a CJIS Security Awareness Form #51. Employees are directed to Chapter 4, Section 116 regarding METERS / NCIC functions and the applicable Agency policy. Some employees may not need METERS / NCIC access, but will still need a LOGIN ID number to access certain records and CAD information. Those employees shall be required to complete the Form #51 in order to obtain the LOGIN ID number. Form #51 shall be stocked by the Director, Information Technology Division, who shall supply this form as needed to employees who require LOGIN ID numbers. Supervisors or managers of units who have a frequent use for this form may request a supply to keep at the unit level.

#### **3-231.1 UNLOADING THE NETWORK**

When an employee has stopped using an Agency network, even for a short period of time, the employee shall completely log off the network. This will free the network for quicker access by another user. Employees who log on to a network and then go about other duties, not requiring the use of the network, can unnecessarily slow the response of the network to all other users.

### **3-232 AGENCY ELECTRONIC MAIL (EMAIL), VOICE MAIL AND INTERNET USAGE - GENERALLY**

The Charles County Sheriff's Office has made available to its employees the use of electronic mail (email), voice mail, and access to the Internet. Because of the potential for misuse of these systems, it is necessary to institute policy to govern their usage. All personnel shall comply with this policy unless some exigent circumstance prevents compliance, and then the employee shall be prepared to justify why the policy was violated. Notification shall be made to the Director, Information Technology Division detailing the nature of, and reasons for, non-compliance.



**Administrative and Operational Manual**

**September 12, 2022**

Just as with the Agency computer systems, email, voice mail, and Internet access are considered the property of the Charles County Sheriff's Office, and are subject to monitoring and inspection at any time. Employees should not expect nor infer any rights to privacy when utilizing these systems. All equipment, software, files, disks, diskettes, communications, messages, recordings, programs, information or data of any kind acquired, created, maintained, sent, or received on any system or diskette provided by the Agency are the property of the Charles County Sheriff's Office.

The Agency therefore has and reserves the right to access, enter, search, inspect, monitor, retrieve, read, and disclose any message, communication, information, or file on the email and voice mail systems used or operated by the Charles County Sheriff's Office at any time and for any reason. The Agency also reserves the right to access, search, inspect, and disclose any file contained on any diskette located within the Agency or that is kept with files belonging to or provided by the Charles County Sheriff's Office at any time and for any reason.

Messages sent, received, or information downloaded shall be limited to Agency-related matters. Voice mail, email and Internet access will not be used to conduct personal business. Use of Agency-provided voice mail, email, and Internet access is a privilege which can be revoked if abused.

**3-232.1 CONTENT OF EMAIL AND VOICE MAIL**

Personnel should give careful consideration to the content of any electronic correspondence. Email and voice mail should be prepared, received, and treated with the same care and formality as written, non-electronic correspondence. Due to the Agency's responsibilities and the nature of law enforcement activities, all Agency-related correspondence should be considered privileged and confidential to the Charles County Sheriff's Office. Disclosure of this information could adversely affect Agency operations, ongoing investigations, and internal personnel matters.

Personal, confidential access, passwords, or personal hard disk drives do not create any expectations of privacy for those using Charles County Sheriff's Office equipment. Deleting or erasing material from the various systems does not interfere with the Agency's ability and prerogative to retrieve that material.

All personnel must remember that any information transmitted electronically or by voice is subject to interception and should act accordingly. If uncertainty exists as to whether or not information should be transmitted due to its content, employees should err on the side of caution.

**3-232.2 INTERNET USAGE**

Internet access is a privilege primarily designed for Agency-related activities. Abuse of that privilege will result in access denial. Sites accessed through the Internet and downloads are subject to tracking, and inappropriate conduct regarding either can result in disciplinary action. Online services take up bandwidth on the system, possibly slowing access for other users. Personnel must be cognizant of this when utilizing list servers and/or downloading information.

**3-232.3 PROCEDURES FOR USAGE OF COMPUTER EQUIPMENT AND ELECTRONIC COMMUNICATIONS SYSTEMS**

The following section of specific policy applies to all personnel, regardless of rank, position, or assignment.

- No confidential or privileged information may be transmitted electronically unless there exists a legitimate law enforcement purpose to do so;
- Proper professional / business etiquette shall be exercised in all email and voice mail communications;



Administrative and Operational Manual

September 12, 2022

- Internet access will be limited to approved, legitimate Agency-related activities;
- Agency equipment shall not be used to access any adult-oriented sites at any time, except pursuant to a legitimate, ongoing investigation. This includes, but is not limited to, any pornographic-related sites;
- All downloaded executable files, including screensavers, are to be installed or approved by the Director, Information Technology Division or his designee;
- Linking to any continuous online service, including, but not limited to, sports-tickers or stock-tickers, is strictly prohibited;
- Subscribing to any list-servers or conducting any transaction electronically, which has the potential of incurring any cost whatsoever, without first receiving written approval of the Sheriff or his designee is strictly prohibited;
- Interception of other employees' electronic or voice mail communications is prohibited, except as permitted by this policy or as authorized by command level authority;
- Downloading, printing, copying, or re-transmitting defamatory, harassing, offensive, discriminatory, slanderous, libelous, or otherwise inappropriate material is strictly prohibited;
- Using electronic or computer equipment in violation of federal or state law, Agency policy, property, copyright, trademark, or trade secret interests of others is prohibited;
- Access to Agency computer and electronic equipment and systems is expressly restricted to Agency personnel; and
- Email and voice mail use is restricted to Agency-related communications only. Personnel are not to utilize these systems for personal communications.
- Employees with email shall check their email at least once each tour of duty in order to stay current with Agency-related communications and to ensure that email messages are responded to in a prompt and courteous manner.

Additionally, employees are prohibited from engaging in, downloading, transmitting or re-transmitting any of the following:

- chain-mail messages;
- illegal or malicious communications;
- political campaigning or solicitations;
- games;
- "chat room" conversations;
- jokes; and/or
- purchases or inquiries pertaining to trades, auctions, or other personal commerce including, but not limited to:
  - stocks and bonds;
  - e-commerce; and
  - travel arrangements.

A violation of any part of this policy will subject the employee to disciplinary action up to and including termination of employment.

**Administrative and Operational Manual****September 12, 2022****3-232.4 INTRANET BULLETIN BOARD**

The Agency's Intranet Bulletin Board is available to CCSO employees who wish to make general announcements to the Agency as a whole. Employees are able to create a posting by accessing the Intranet site and completing an electronic announcement application. Once posted the announcement will be kept on the site for thirty (30) days and then automatically purged. The author may then choose to recreate the posting after that time. Only ITD personnel or the author of the announcement may modify or delete a posting's contents.

The Bulletin Board is offered as a benefit for Agency employees and shall not be used to advance a personal or political agenda, post any obscene or questionable material, nor advertise a business or the sale of merchandise for friends. Each application for posting is reviewed by the Director of ITD or a designee and may be removed from the Intranet for cause. Employees who wish to create a posting will do so only from their own "Log On" account on an Agency computer and will at no time utilize another employee's "Log On" identification.

**3-234 SOCIAL NETWORKING - AGENCY ACCOUNTS**

The use of mainstream social networking tools such as Facebook and Twitter can be very useful to the Agency as a means of communicating with the public in a modern forum. These tools can provide the public with convenient and timely access to information, such as:

- awareness of crime within the community;
- assistance in ongoing investigations;
- identifying and locating fugitives;
- recent and upcoming Agency activities;
- recruitment and employment opportunities.

**3-234.1 MANAGEMENT OF NETWORKING ACCOUNTS**

Agency social networking accounts are established and supported by ITD staff. The Media Relations Office will have primary responsibility for the maintenance of the content contained on or distributed through the sites.

Media Relations will rely heavily on personnel in Human Resources, Judicial Services, CID, and other sections to contribute information in a timely manner to facilitate the distribution of information while it is still fresh. This may require postings to be made within minutes of an incident occurring, such as for ongoing dangers within the community, critical missing persons, or major traffic disruptions.

Designated personnel within the Media Relations Office will have primary responsibility for reviewing the content of information posted or contributed by the public in an attempt to ensure the information is not inappropriate or offensive to other readers.

**3-234.2 AUTHORIZATION OF POSTINGS**

The Media Relations staff will have overall authority of what is posted and distributed through the social networking sites and will determine what information is posted and the duration the postings will remain on the sites. That authority shall only be superseded by the Commander, Executive Services, the Assistant Sheriffs, or the Sheriff.



Administrative and Operational Manual

September 12, 2022

### 3-234.3 REMOVAL OF POSTINGS AND ASSOCIATIONS

As a networking tool, social networking accounts have the tremendous benefit of being able to provide feedback from the community on the postings the Agency creates. This ability provides for not only positive, but also negative feedback.

As the manager of the accounts, Media Relations shall review postings or remarks made by citizens as well as the people associating themselves with the Agency. Media Relations will ensure the feedback posted by the community reflects the values of the Agency and ensure there is no offensive language or other inappropriate content which would reflect negatively on the Agency.

Media Relations will also review the associations made, commonly referred to as “followers” or “fans,” to ensure these associations do not bring discredit to the Agency.

If offensive material or postings are discovered, they shall be immediately removed from the accounts’ postings by Media Relations. If an association is made or attempted which would bring discredit to the Agency, Media Relations will take steps to remove the association.

Media Relations will provide the public with disclaimers making them aware that the Agency does not condone any offensive postings made by the public and reserves the right to remove any postings or associations.

### 3-234.4 PERSONAL USE OF SOCIAL NETWORKING SITES

The Sheriff’s Office recognizes that employees do not surrender their First Amendment rights solely because of the nature of their employment. On the other hand, like all government agencies, the Sheriff’s Office also has an interest in providing effective and efficient services to the public. The community must have confidence in the Sheriff’s Office, and the Sheriff’s Office must always strive to preserve dignity and professionalism in its relations with the community.

The interplay between a government employee’s right to free expression and a government agency’s right to promote the efficiency of its services is a complex one and has been the subject of dozens, if not hundreds, of court cases for over half of a century. In general, the law can be summarized as follows:

- The more an employee’s expression is related to matters of “public concern,” the greater protection it has. Conversely, expression that is purely personal may not receive any protection at all.
- The more the employee’s expression is divorced from the employee’s duties with the government agency, the greater protection it has. Conversely, expression that could be reasonably construed as “job-related” has much less protection. (This does not mean that an employee may not speak in public about the operation of the Sheriff’s Office; to the contrary, employees have a unique ability to provide meaningful input to discussions about law enforcement in general and Charles County in particular. However, such expression receives greatest protection when done off-duty, not in uniform, and where the circumstances are clear that the expressions are the speaker’s own, and not the Sheriff’s Office’s.)

Social networking sites such as Facebook or Twitter are powerful platforms that allow each of us to forge and maintain connections with large numbers of people with very little effort. Social networking sites are also easily abused, and a careless, thoughtless, or rash posting can have great, unintended negative consequences. Social networking sites include, but are not limited to, such interactive services as Facebook, Twitter, Instagram, LinkedIn, and include blogs, photo and video sharing services, and podcasts.

All employees must use sound judgment when interacting with others on social networking sites. Nothing is ever truly private on the internet. Employees should avoid posting or “liking” content that they would not be comfortable sharing with their coworkers or family members. Employees should also be mindful that sharing, endorsing, or

**Administrative and Operational Manual****September 12, 2022**

“liking” someone else’s post is functionally the same as posting the content directly. Employees must also remember that their social media postings may be intercepted or viewed by unintended people and could be used to impeach the employee in court. Postings could also be converted by others and used on anti-police websites or other platforms to embarrass, harm, or endanger the employee or others.

Providing a comprehensive list of expressions that are either protected or subject to discipline is difficult in the legal sense and impossible in the practical sense. However, employees are expected, at a minimum, to adhere to the following policies:

- Employees are not to access social networking sites for personal use during duty hours. Sites may only be accessed for official business purposes, such as for conducting investigations.
- Photos or videos taken while on duty at crime scenes or on police-related calls and events are the property of the Sheriff’s Office and shall not be posted on social network sites. No photos or videos will be taken, printed, downloaded, or distributed for any employee’s personal use and/or beyond the scope of an employee’s official capacity or duty assignment.
- Employees shall not purposefully or negligently disclose any information that is confidential or law enforcement sensitive. This includes information or details concerning:
  - Criminal or traffic investigations;
  - Administrative investigations or actions;
  - Calls for service, traffic stops, vehicle crashes, and other contacts with citizens; and
  - Personnel issues, including disciplinary actions, transfers, etc.
- Employees may discuss or comment on matters already released to the public, such as press releases or court cases, but may not disclose information that has not already been made public.
- Employees shall not post or publish content that might be reasonably interpreted as harassing, defamatory, racially, ethnically, or sexually derogatory, or sexually violent.
- Employees shall not post or publish content that violates federal or Maryland law, including copyright laws.
- Employees must honor the privacy rights of other employees and seek permission before posting or publishing content that could reasonably be considered a breach of the employee’s privacy or confidentiality.

Failure to comply with these policies and/or engaging in social media behavior that interferes with or impairs the operation and mission of the Sheriff’s Office may result in disciplinary action to include termination.

### **3-235 MOBILE DATA TERMINALS**

The Charles County Sheriff’s Office will use wireless communication technologies through Mobile Data Terminals (MDTs) to enhance the operations and security of the Agency. Employees assigned, or who have access to, a Mobile Data Terminal shall use the system in conformance with the rules and procedures outlined in this policy.

The MDT is designed to enhance the officers’ ability to utilize the information found in the Agency CAD and RMS systems, utilize computerized reporting, and have access to MVA, METERS, and NCIC information in a mobile environment.

#### **3-235.1 GENERAL POLICY**

It shall be the policy of the Charles County Sheriff’s Office to use the MDT system to support the Agency’s operations



**Administrative and Operational Manual**

**September 12, 2022**

and activities. It is the responsibility of each employee to ensure that this technology is used for proper business purposes and in a manner that does not compromise confidential, protected, restricted, or other sensitive information.

The Director, Information Technology Division, is responsible for the support and operation of the MDT Program, to include training, maintenance and repair of all equipment. This will also include communication and interaction between federal, state, and local agencies that support the MDT Program.

MDT usage is restricted to those Agency employees who have been trained in the proper use of the equipment and who have been certified to access the systems available.

The Director, ITD will be responsible for the daily administration of the MDT Program. Additionally, he will conduct random administrative security checks of the MDT system to ensure that all necessary security procedures are being followed.

**3-235.2 MDT USER RESPONSIBILITIES**

MDT users shall attend all scheduled MDT related training, when notified. Should a conflict exist between scheduled training and another assignment, the MDT user shall inform his supervisor of the conflict. The supervisor shall ensure the officer's commander and the ITD Helpdesk are contacted and the conflict is resolved.

MDT users are responsible for maintaining all certifications, which allow access to CJIS / NCIC and other databases retrievable by an MDT. Problems with access to these systems will be reported immediately to the Terminal Agency Coordinator (TAC), ITD, and the ITD Helpdesk.

The TAC, within the ITD will notify the ITD Helpdesk and the officer's supervisor of any lapse in the officer's CJIS / NCIC certification.

Users' passwords to access the MDT system and CJIS / NCIC shall not be shared or made known to any other individual. Users who have reason to believe that their password has been compromised shall immediately notify the ITD Helpdesk and change their password utilizing the procedures outlined during MDT training. Attempts by any member to utilize an MDT or gain access to CJIS / NCIC with another member's password is strictly prohibited.

Responses from inquiries to CJIS / NCIC are protected information. Officers are not permitted to use these systems for their own use, and information received through these computer systems may only be used for official criminal justice purposes. Officers will not initiate any inquiry outside those purposes necessary to complete an Agency objective. Officers will ensure that unauthorized persons, to include passengers or offenders located in the vehicle, do not view responses from these systems.

For officer safety, the MDT should always be secured in the vehicle mount designed for that vehicle and installed by CCSO or an Agency approved contractor.

**3-235.3 GENERAL MDT USAGE**

Safe operation of vehicles equipped with an MDT is paramount. Common sense and safe driving practices dictate that the officers will focus their attention on safe operation of the vehicle and will utilize the MDT only when safe to do so.

Officers assigned an MDT will log into the XMobile computer system at the beginning of each shift. The MDT will remain on and logged into XMobile as a CAD user at all times while the officer is on duty. The officer will also have mapping software and other Agency records systems available for use through the MDT.

Officers utilizing the MDT as a CAD user will be dispatched to calls for service both by voice and with CAD messages





Administrative and Operational Manual

September 12, 2022

through the MDT. Officers will acknowledge receiving the call by using the radio system. The officer will then use the MDT to place themselves en-route to the call once they actually begin to respond to the call. If the nature of the response does not allow the officer to use the MDT, the officer should use the radio system to notify Communications they are en-route to the call.

Once an officer arrives at the scene of a call, they will use the arrive function of the MDT to place themselves on the scene. If the officer feels it would be safer to voice their arrival or if they are on a call with a non-MDT user, they should also use the radio to arrive.

While handling incidents, the officers will have the ability to update their event sheets with information they consider necessary for documentation. When clearing a call for service, the officers will use their radio to provide Communications with a disposition. The PCO working the call will then close the call with the proper closure code. All incident numbers will continue to be generated and provided to the officer by Communications.

Officers may generate their own calls for service with the MDT. This should be done only for routine incidents that allow the officers to divert their attention away from the incident to enter the information needed into the MDT. For all other incidents, the officers should use their radio to notify Communications of the incident.

By their nature, traffic stops require a high level of attention by the officer(s) conducting the stop. Because of that, the MDT will not be used to generate a traffic stop. While on the stop the officer may use the MDT to perform records checks through various computer systems if they feel doing so does not create a risk to the officer.

Nothing in these procedures shall prevent an officer from choosing voice communication over MDT transmissions when:

- the nature of the call or its location has a safety concern to the officer;
- the officer is unable to use the MDT to determine the location or nature of the call;
- the officer is unable to respond with the MDT or there is an equipment malfunction;
- changes in location cannot safely be updated by using the MDT;
- when en-route to a call, the officer is diverted by a serious incident requiring their immediate attention; or
- any other situation in which the officer believes using voice transmission creates a safer environment.

Officers must remember that a positive response through the MDT is no different than any other computerized system. All HITS must be confirmed with the entering agency before any property can be seized or any person can be arrested. All hit confirmations will be performed through Communications in accordance with CJIS training.

When an officer is in his vehicle in an off-duty status, they may use the MDT, but must log in as a Non-CAD user. If the officer handles or assists on a call for service, they will be temporarily placed on duty in the CAD system. During that time, the officer may log into the MDT as a CAD user and use the dispatching resources.

### 3-235.4 SOFTWARE / HARDWARE MAINTENANCE

All MDTs, data, and software maintained or used by the CCSO are for official use only. No employee will use or cause to be used any MDT for personal gain or benefit of any kind. Only software purchased or acquired by the Sheriff's Office will be installed on an MDT. All software and hardware installation, modification, or deletion shall be done by authorized ITD personnel or an ITD approved contractor. Users are not permitted to download or install software (i.e., games, music, screensavers, wallpaper, etc.) without the written approval of the Director, Information Technology Division.

If any equipment needs to be serviced, repaired, or reprogrammed, a request will be sent to the ITD-Helpdesk by using the Computer Hardware-Software Request Form #49. All MDT repairs shall be done by authorized ITD personnel or ITD approved contractors.

MDT users shall report all system related problems to their supervisor prior to the end of their shift. The supervisor

**Administrative and Operational Manual****September 12, 2022**

shall determine if the problem is isolated to that MDT or is system-wide. Supervisors shall report all system-wide problems to the ITD Helpdesk or the on-call ITD person as soon as the problem is discovered. For isolated MDT problems, a Computer Hardware-Software Request shall be completed by the officer and submitted prior to the end of their shift.

If a vehicle is taken out of service due to a collision or prolonged maintenance, the MDT must be removed from the vehicle and maintained by the employee or turned into the Director, Information Technology Division.

The investigating officer shall notify the Director, Information Technology Division when an Agency vehicle equipped with an MDT has been involved in a serious collision. The MDT will be examined by ITD to check for damage. If the MDT is damaged, ITD will complete all necessary repairs and re-issue it back to the employee.

Certain software in the MDT will be automatically updated, while others may require the user to manually perform the update. For the manual updates to the computer's software, the user will comply with instructions provided by ITD personnel and perform updates when and how instructed. This will ensure the most up-to-date software is operating in the MDT.

### **3-235.5 CARE OF EQUIPMENT**

The MDT will be securely locked into place on the docking station while the computer is in a vehicle. The key for the locking system will not be left in the station but will be kept with the vehicle operator. The MDT will be removed from the vehicle during times the officer is scheduled for extended periods of leave greater than three or more days. Although the terminal is a rugged model, care must still be used in handling the computer. Avoid exposing the computer to moisture, including rain and snow, as well as beverages. If spillage does occur:

- log off all active sessions and shut down the MDT as quickly as possible;
- clean the affected area; and
- notify the ITD Helpdesk or a designee as soon as practical to inspect the unit.

The MDT is capable of operating in extreme temperatures; however, it may not function properly until it returns to an ideal operating range. In extreme cold, the computer may not function until the unit warms up. In the extreme heat of summer, the unit may not work properly until the ambient temperature of the vehicle has cooled.

Care should be used in cleaning the screen of an MDT. An anti-static cleaning cloth should be used to clean the screen. Another cleaning method is the use of a soft cotton cloth lightly moistened with water. No cleaning solution should ever be used to clean the screen or computer housing.

For MDTs that have a touch-screen system option, an operator will use only a fingertip or the stylus pen that was provided with the terminal. Under no circumstances will an ink pen be used on the screen. The use of an ink pen will cause damage to the screen.

Supervisors will inspect each officer's MDT monthly. The supervisor shall check the hardware and software for functionality. The results of the inspection shall be documented on the vehicle monthly inspection form.

### **3-235.6 ELECTRONICALLY TRANSMITTED CORRESPONDENCE**

All electronic messaging / correspondence is the property of the Charles County Sheriff's Office and is assigned to the Charles County Sheriff's Office. Any electronic message that is sent through the MDT system may be retrieved by authorized personnel later, even though it may have been deleted from the assigned employee's computer. Electronic messages are not a protected form of communication and could be subject to a discovery motion in a criminal / civil case or an internal investigation.

Users shall have no expectation of privacy, express or implied, of any information sent over or stored on issued MDTs or the Mobile Data Network. This Agency will control all access to any and all information stored in these



**Administrative and Operational Manual**

**September 12, 2022**

devices, networks, and/or systems at all times.

Offensive, demeaning or disruptive messages are prohibited. Any message containing slang or language that could be construed as a slur or sexual harassment against any person or group will not be tolerated. All transmissions are recordable and retrievable.

### **3-235.7 MOBILE PRINTING**

Officers using MDTs will have the ability to print from their MDT. Any printout of sensitive information should be guarded and not provided to anyone without a legitimate law enforcement purpose. All printouts made from the MDT shall be disposed of properly to safeguard the information.

The Agency will provide mobile printers to each officer assigned an MDT. Printers shall be mounted in an approved printer mount designed for that vehicle. Officers should use care when using the mobile printer so that the printer and any connecting cables do not become a hazard to the operation of the vehicle.

Supplies such as paper and new ink cartridges will be available at each district station. Officers are to obtain supplies for their printers as needed. Stockpiling of ink cartridges could cause the ink to be unusable when needed.

In addition to the mobile printers, the MDTs may be connected to printers on the Agency network. When using a network printer, the officer must ensure the material printed will not be compromised by the location of the printer.

### **3-235.8 OPERATING PROCEDURES FOR WIRELESS MOBILE COMPUTING DEVICES**

MDT users will be mindful of regulations governing the use of the device. The user will deactivate the device in areas where radio devices are forbidden, or when it may cause interference or danger. Any restrictions on use pertaining to cell phones and CCSO two-way radios will apply to an MDT (e.g., transmitting within 200 yards of a blasting operation). Similar to departmental radio transmissions, special attention should be used in the following areas: fuel depots, chemical plants, blasting operations, and other areas where radio transmissions are restricted.

Wireless mobile computing devices may interfere with the function of inadequately protected medical devices, including pacemakers.

### **3-235.9 AUTOMATIC VEHICLE LOCATION (AVL)**

As a part of the MDT project, certain vehicles or computers are equipped with Automatic Vehicle Location systems (AVL). AVL is a GPS-based locating system which will provide the location of a police vehicle as well as the status of the unit assigned to the vehicle. The mapping system utilized with the AVL will also plot the location of active calls for service throughout the county. This software / hardware system was designed with the purpose of increasing officer safety while providing officers a tool that allows for easy unit and call-for-service orientation.

The information provided by the AVL system is not designed to be used as a disciplinary tool; however, the data may be used to support investigations of Agency violations as well as criminal violations. In those instances, the data may be used only with the prior approval of the Sheriff. In any case, AVL data will not be used as the sole source of information in any disciplinary case.

Regardless of a person's assignment, any employee with a vehicle-mounted MDT will log on to their MDT at the beginning of their tour of duty. This will include logging into the XMobile system, which will automatically activate the AVL system.



**Administrative and Operational Manual**

**September 12, 2022**

---

Off-duty units will not be displayed on the AVL system unless they are placed in an on-duty status by Communications and then logged into the XMobile system as CAD users.

Employees are prohibited from intentionally manipulating the system's software or hardware in any way to prevent the proper use of the AVL system. The only exception to the required operation of AVL will be upon the specific authorization by the employee's division commander.



## Administrative and Operational Manual

September 12, 2022

**3-240 LICENSE PLATE READER PROGRAM**

The identification of stolen vehicles, stolen license plates, and wanted and missing persons is the primary focus of the License Plate Reader program. LPR technology utilizes cameras and computer software to capture number sequences and compares them to lists of license plates of interest. The license plates of interest are referred to as a “hot list,” which is a database uploaded daily by LPR users at the beginning of each shift. The LPR system also has the capability of recording and storing vast amounts of license plate numbers and can be used as an investigative tool.

LPRs can be either permanently mounted to a patrol car or utilized in a stationary position for investigative purposes. The Information Technology Division is responsible for the installation and maintenance of the LPR system equipment / server and will maintain a detailed inventory record of all system equipment. The Director, Information Technology Division must pre-approve the installation or transfer of any LPR system. Only officers who have been trained in the use of the LPR system and are assigned a proprietary license are authorized to use the system. Use of the LPR system is restricted to official law enforcement purposes, and no member may use or authorize the use of the system for any other reason.

The Director, Information Technology Division will designate a LPR Program Administrator who is responsible for logging into the Agency’s LPR system website and updating the LPR system “hot list” daily. Any problems experienced by a system user will be directed to the LPR Program Administrator immediately.

All LPR system data collected by the Agency’s LPR program will be maintained on an Agency server which is connected to the Maryland Coordination and Analysis Center (MCAC). Only authorized personnel may access LPR system data on the Agency server. Collected data will be stored no longer than one year prior to purging unless it has become, or it is reasonable to believe that it will become, evidence in a specific criminal or civil action. Data held as evidence which may inculcate or exculpate a suspect, is subject to the rules of evidence. This evidence may also be known as “Brady material” (Brady v. Maryland, 373 U.S. 83 (1963)), and must be preserved and made known to the prosecution. Preserved data will be done under the authority of the LPR Program Administrator, who will download the data to a CD or other portable storage device. This will be documented in a memo and become a permanent attachment to the specific case file. The downloaded CD or other storage device will be handled as evidence and subject to chain of custody and handling as would any other evidence.

All outside-Agency requests for information from the LPR System Administrator must be made in writing to the Director, Information Technology Division. Internal requests may be made through CID and the LPR System Administrator. Those requests must serve a legitimate law enforcement purpose and will be recorded on a LPR Program Data Query Log. The log is subject to Agency retention policies outlined elsewhere in the AOM and on the Agency Intranet.

Officers assigned a LPR will activate the unit prior to beginning their tour of duty by logging onto the Agency’s LPR system website. The unit will automatically download the current “hot list” and any other pertinent uploads. If it becomes necessary after the initial upload to add specific information, the database can be “customized” by manually entering information. This option should be utilized only in cases where crimes have been reported after the LPR is in use; i.e., stolen vehicles, AMBER alerts, radio item broadcasts, etc. Custom manual inputs will be performed by the LPR Program Administrator and require authorization of a commander or shift supervisor.

At this time, the LPR system does not interface with real-time METERS and NCIC data. The information received from license plates that are recognized as “hits” is dated and may be up to 24 hours old. Officers who receive an alarm of a positive “hit” on a scanned license plate will compare the digital image to the NCIC or METERS information and verify the “hit.” Verified “hits” will be accepted by activating the “Accept” alarm key on the video monitoring center screen on the MDT. If the “hit” is not verified, the officer will activate the “reject” alarm key. The officer will then confirm the license plate information and relay this information to Communications, who will confirm the “hit” according to current Agency policy prior to any enforcement action being taken. The LPR system is to be used only as an investigative tool.



**Administrative and Operational Manual**

**September 12, 2022**

---

The mobile data terminal in the vehicle will act as a video monitoring / data collection center. This is the central clearinghouse for all license plates scanned by the LPR system. Collected data will be maintained on the MDT and transmitted wirelessly to the Agency server. All scanned data on the MDT will be stored for 30 days. After 30 days, the LPR system will begin purging the data by automatically overwriting the data.

LPR units affixed to an Agency vehicle are exposed to the elements and require cleaning according to manufacturer's recommendations. At no time will a vehicle with an affixed LPR be driven through or cleaned by an automatic car wash facility. Officers will inspect the LPR unit at the beginning of their tour of duty and report any issues or damage to the Director, Information Technology Division through the officer's chain of command, per Agency policy for damaged equipment.

### **3-240.1      AUDIT**

On a yearly basis, the Director, Information Technology Division will conduct an audit of the data collected / shared by the LPR program. The Director will ensure a report is prepared and forwarded to the appropriate locations in compliance with Maryland Annotated Code § 4-326.



Administrative and Operational Manual

September 12, 2022

### **3-250 MOBILE FINGERPRINT IDENTIFICATION SYSTEM (FIS)**

The Mobile Fingerprint Identification System (FIS) consists of a handheld fingerprint scanner designed to capture images of the index fingers of the right and left hands. The unit will maintain the images only until it is connected to the laptop and sent for search.

#### **3-251 PURPOSE**

The purpose of this policy is to establish guidelines related to the use of the Mobile Fingerprint Identification System (FIS). The use of the mobile scanner is intended to provide law enforcement personnel with an automated method of identifying persons who cannot provide other means of identification or to provide a verification of the presented identification documents. The search is conducted against a criminal database.

#### **3-250.1 POLICY**

The use of the mobile fingerprint scanner shall be for law enforcement purposes only and done in a manner consistent with local, state, and federal laws. Only those officers who have special credentials established with CJIS will operate the scanners.

#### **3-252 CONSENT PRIOR TO SCANNING**

If the individual stopped is not under arrest, consent to scan their fingerprints must be obtained. This consent can be verbal or in writing. A person can revoke their consent at any time during the scanning process. If the person refuses to allow their fingerprints to be scanned, no scanning will be conducted unless probable cause for a custodial arrest is present or a search warrant is obtained. Individuals who are deceased, unconscious, or unable to give consent, but who are in need of assistance, may be scanned for identification purposes only.

#### **3-253 PROCEDURE**

When using a mobile fingerprint scanner in the field, it is recommended that two or more officers be present at the stop before the unit is utilized. This is to ensure the safe handling and control of the individual during the fingerprint scanning process.

The system will search the fingerprint images against the databases (MAFIS, CJIS, FBI). If the individual has been previously processed, a positive notification should be returned. The return will consist of the basic demographic information that is available. In some cases, the system may return an identification number only. If no match is found, the return message will indicate that there is no record on file.

A positive return is only summary in nature and is an indication of prior police contact and NOT considered probable cause (PC) for an arrest. Verification and/or additional information (i.e., local records checks) should be completed to fully verify the identification. Within 5 minutes of a FBI hit there is the possibility of a call from the FBI to Communications concerning the person fingerprinted. It should be understood that a FBI hit means the person should be detained until cleared by the FBI. Depending on the return, the officer may need to contact Communications for either confirmation of the FBI hit or to request back-up.

Images can be deleted from the system manually, or the images will be permanently deleted from the system when the handheld device is turned off, or the software on the laptop interface is closed.

Under no circumstances shall officers share FIS data with any non-law enforcement agency. Division commanders will ensure this equipment is maintained per Agency policy.

### **3-290 AGENCY CASH FUNDS**



## Administrative and Operational Manual

September 12, 2022

This policy shall govern the maintenance of all cash funds or accounts where Agency personnel are permitted to receive, maintain, or disburse cash. The Deputy Director, Accounting, in conjunction with division / section commanders and the Office of Professional Responsibility, is responsible for overseeing the maintenance of Agency cash funds and accounts.

The Accounting Section shall be responsible for an on-going accounting of all cash funds and accounts. The Office of Professional Responsibility shall be responsible for conducting a quarterly audit of Agency cash fund activities. Any discrepancies will be reported immediately through the chain of command to the Sheriff. Annually, during the month of April, the Commander, OPR shall forward a written report of the results of all quarterly audits through the chain of command to the Sheriff. Accounting shall maintain records of all transactions made by cash funds of the Agency. The establishment of an Agency cash fund maintained by any component of the Agency requires approval from the Sheriff. In addition, each such fund will meet the following standards:

- a balance sheet, ledger, or other system that identifies initial balance, credits, debits, and the balance on hand will be maintained;
- receipts or documentation for cash received will be created;
- authorization requirements for cash disbursements up to \$2,000 shall be determined by the commander responsible for the fund (or his designee) and detailed in the respective SOP;
- authorization for cash disbursements above \$2,000 will be made only upon the authorization of the Sheriff, Chief of Staff or an Assistant Sheriff;
- records, documentation, or an invoice is required for cash expenditures;
- only those persons who are assigned to a specific task requiring the handling of cash and their supervisor / manager are authorized to disburse or accept cash; and
- each commander will require a quarterly accounting of any cash fund under that commander's control (this accounting may be accomplished by OPR).

### 3-290.1 AUTHORIZED AGENCY ACCOUNTS

The following are the only cash fund accounts authorized and maintained within the Agency:

**Criminal Investigations Division, Investigative Funds** - The Sheriff has approved a cash fund of \$2,000 to be utilized for investigations. These funds are maintained and disbursed by the Commander, Persons Crimes Section, who is the custodian of the account.

**Homeland Security & Intelligence Section, Investigative Funds** - The Sheriff has approved a cash fund of \$5,000 to be utilized for Homeland Security and Intelligence investigations. These funds are maintained and disbursed by the Commander, Homeland Security & Intelligence, who is the custodian of the account.

**Narcotics Enforcement Section, Investigative Funds** - The Sheriff has approved a cash fund of \$5,000 to be utilized for narcotics / vice investigations. These funds are maintained and disbursed by the Commander, Narcotics Enforcement Section, who is the custodian of the account.

**Judicial Services Section, Extradition Funds** - These funds are maintained and disbursed by the Commander, Judicial Services Section. The Sheriff has approved a cash fund of \$1,000 to be utilized for extraditions. To request replenishment for this fund, the Commander will prepare either a Travel Expense Report Form #183 or a Supply Requisition Form #302.





Administrative and Operational Manual

September 12, 2022

**Quartermaster, Uniform Sales Funds** - These funds are collected, recorded, and deposited by the Agency Quartermaster. Agency employees purchasing uniform items may pay by check or must have exact change for cash purchases. For each transaction a three-part receipt is completed by a Quartermaster employee. One copy is issued to the employee, one copy goes to file and one copy is kept with the payment and placed in the Quartermaster's safe. A transmittal form is prepared and sent to the Deputy Director, Accounting Section with the actual deposit on Friday of each week when funds for sales exceed \$50.00.

**Property Auctions, Non-Recurring Revenue Account Fund** - Public auctions of property are normally conducted twice a year and are handled by the Property Management Section of the Special Services Division. The money received as a result of these auctions is in the form of cash only. Since no cash is kept on hand, cash used for making change on the day of the auction is borrowed from the fund maintained by the Judicial Services Section. This cash is returned upon completion of the auction and accounted for in the Judicial Services Section records.

The Property Custodian or other designated employee in charge of the auction shall complete a memorandum detailing the auction and the dollar amount collected. The memorandum, along with the cash received, is then hand carried to the Accounting Section. Accounting will verify the amount and a cash receipt will be completed and provided to the Property Custodian.

The funds are then to be deposited with the Charles County Treasurer's Office by Accounting. A transmittal form prepared by Accounting shall list the account name, account number, a revenue code, and a dollar amount. This deposit will be hand carried to the Treasurer's Office. Once the deposit is accepted by the Treasurer's Office, a stamped copy of the transmittal form will be filed in the Accounting Section.

A copy of all records relating to the auctions shall be provided to OPR for its accounting process. This information is attached to the transaction report for the quarter in which the auction is held.

**Sheriff's Office Awards and Special Events Account Fund** - The Sheriff's Office Awards and Special Events checking account is maintained by the Executive Administrative Coordinator. This account is established to provide funds to cover expenses related to expressions of sentiment in the name of the Agency, and other special events as authorized by the Sheriff. Funds for this account are received from vending machines, disciplinary fines paid by Sheriff's Office employees, and any donations received and designated for the Awards fund.

All funds received are to be deposited on a weekly basis by the Executive Administrative Coordinator. Deposit slips shall be held in the checkbook until the monthly bank reconciliation report has been completed by Accounting.

The reconciliation report will cover all transactions relating to the period of time covered by the bank statement. A copy of the monthly reconciliation report will be forwarded to the Assistant Sheriff of Administration, the County Government's Accounting Office, and, for Agency accounting purposes, a copy will be maintained in the Accounting Section.

Once the bank reconciliation has been completed, the Executive Administrative Coordinator will file the deposit information in an account revenue file for the appropriate fiscal year.

**Fingerprinting Service Fund** - This program is the responsibility of the Community Services Section, and the service is under the supervision of the Community Services Commander. The fees for this service are collected in the form of either a money order, cash or credit card.

All funds collected are recorded in a three-part receipt book. The original white copy is given to the customer, the yellow Agency copy is attached to the sign-in sheet for submission with the funds for deposit to the Charles County Treasurer's Office, and the pink copy stays in the book, to be returned to Accounting when the book is completed. All funds received are counted by the Electronic Fingerprint Technicians. The funds are placed in a small envelope. The breakdown of funds collected is recorded on the envelope, verified and sealed by the Fingerprint Technician. This envelope, along with a transmittal form, receipts, and sign-in sheet, is hand carried to the Charles County Government - Waldorf Treasurer's Office at the end of each evening when fingerprint services are performed.



## Administrative and Operational Manual

September 12, 2022

Once the deposit is accepted by the Charles County Government Treasurer's Office, a stamped copy of the transmittal form, along with the receipts and sign-in sheet, is sent to Accounting to be filed in the Accounting Section master file. A periodic audit of receipts versus deposit amounts will be performed by Accounting to ensure that funds received and deposited match.

**VICS (Volunteers in Community Service) Fund** - The Sheriff has approved a cash fund of \$250 to be utilized to make change when processing VICS clients who are registering for community service and need change. These funds are maintained and disbursed by the VICS Supervisor, who is the custodian of the account.

When a client comes into the VICS office, one of the VICS Specialists will register the client by taking the payment of cash, credit card, or money order. No personal checks will be accepted. The client's schedule and fees are entered into the VICS computer system.

The payment is stapled to the VICS copy of the court paper, immediately placed into the drop safe, and is reconciled at the end of each day when the official deposit is made. At the end of each business day, one of the VICS Specialists will run a computer-generated report which is used to determine the amount of funds received for that particular day. This report is placed into the VICS safe and used when the funds are reconciled by the VICS Supervisor.

The VICS Supervisor runs another computer-generated report and uses the report to verify the funds and information received. The credit card reports are printed from the Velocity Payment System and also verify the total amount of payments received.

A transmittal form is prepared and sent to the Treasurer's Office with the actual deposit. The transmittal form is broken down into three types of payments received: cash, credit card, and money order amounts, and total deposit. The deposit is placed into a locked money bag and carried the next morning to the Charles County Government Treasurer's Office by a CCSO Correctional Officer. The stamped transmittal form and money bag is returned to the VICS office.

The transmittal forms are kept by the VICS office for three fiscal years.

The cash fund of \$250 is counted and reconciled each morning by a VICS Specialist, to ensure the balance is \$250. The reconciliation is documented on a VICS balance sheet and is also held for three fiscal years.

At the end of each week and each month, the VICS Supervisor reconciles the report to ensure that all total funding amounts are in balance. A monthly report is then forwarded to the Commander of Judicial Services.

**Firearms Unit / LEOSA Fund** – The fee for LEOSA Range use is \$50 for all non-Agency retired personnel or members of the St. Charles Sportsman's Club. This program is held on the first and third Thursday of each month. Each person is required to sign in. It is noted on the sign-in sheet beside each person whether or not a fee was collected. Payment is made either by cash or check. At the end of each session, funds are counted and then delivered to the Accounting Section, along with a copy of that date's sign-in sheet. Records for all dates / times this program was held are maintained by the Firearms Unit as required.

**Alcohol Investigative Fund** – This fund has been established through funding from the Board of License Commissioners, and is in the amount of \$100. When replenishment is needed, a request is submitted via memorandum to the Board of License Commissioners for the appropriate reimbursement of funds. A quarterly report will be sent to OPR for accounting purposes.

**Tobacco Investigative Fund** – This fund is established through CCSO, and is in the amount of \$100. When replenishment is needed, a request is submitted to Budgeting. A report is sent quarterly to OPR.

**Brass Fund** – Brass shell casings are collected at the firing range by members of the Training Division; these are periodically turned in to Waldorf Metals for cash to purchase items for the firing range. OPR receives a report on this account quarterly.



Administrative and Operational Manual

September 12, 2022

**Inmate Petty Cash Fund** – This fund is audited by Accounting and replenished as needed up to \$1,000.

**Explorer Fund** – Funds are received by those working with the Explorers and given to Accounting for record keeping and deposit into the bank account. A spreadsheet is maintained of funds received and payments issued, upon approval of the section commander. This account is reconciled monthly by Accounting.

### 3-290.1.1 REPORTING RESPONSIBILITIES OF AUTHORIZED AGENCY ACCOUNTS

Once each quarter a copy of the accumulated transaction reports for the following accounts will be provided by the Accounting Section to OPR for its records and quarterly accounting process. The accumulated transaction report shall list all activities in the account.

- Criminal Investigations Division, Investigative Funds;
- Homeland Security & Intelligence Section, Investigative Funds;
- Narcotics Enforcement Section, Investigative Funds;
- Judicial Services Section, Extradition Funds;
- Quartermaster, Uniform Sales Funds;
- Property Auctions, Non-Recurring Revenue Account Fund;
- Fingerprinting Service Fund.

### 3-290.1.2 PROCEDURES FOR REPLENISHING CERTAIN AUTHORIZED AGENCY ACCOUNTS

To request replenishment for the funds listed below, the Commander in charge of these specific funds will prepare a Supply Requisition Form #302 and submit it to the Accounting Section.

The Accounting Section will process requests for replenishment of funds through the County Treasurer's Office. When funds are available, the Treasurer's Office will contact the custodian, who will pick up and sign a receipt for the cash. A record of all approved investigative fund requisitions will be kept on file in the Accounting Section.

These procedures apply to the authorized Agency accounts listed below:

- Criminal Investigations Division, Investigative Funds;
- Homeland Security & Intelligence Section, Investigative Funds;
- Narcotics Enforcement Section, Investigative Funds;
- Judicial Services Section, Extradition Funds (can also utilize Travel Expense Report Form #183.)

**Administrative and Operational Manual****September 12, 2022****3-300 SUPPLIES AND MAINTENANCE**

It is the responsibility of all division commanders and directors to plan the use of resources for their particular commands. During each fiscal year, the use of resources should be monitored to ensure their use is as planned. Commanders / directors should factor current shortages and surpluses, and any known change of operations that will impact resource use, into each budget preparation cycle.

Budget preparation is not a short-term affair. It requires the continual monitoring of resource use in comparison with the previously planned and approved use of resources. An awareness of the changes in the economy can be helpful in anticipating cost increases and revenue changes that would affect amounts that may be available in the next budget cycle.

Part of the responsibility of command is the management of resources. Each commander / director is charged with determining the needs of his command and submitting a budget request each fiscal year. Likewise, each commander / director is charged with containing the expenditure of resources within the approved budget for his command. Only unforeseeable emergencies will be accepted as cause for exceeding current budget limits. Commanders / directors should be aware of the difficulties created by the necessity to exceed budget levels and do everything possible to prevent such excesses.

**3-301 DIVISION COMMANDERS' / DIRECTORS' RESPONSIBILITIES**

A part of the overall responsibility for operation within budget is the monitoring of the requisition process. Each division commander / director will control the requisition process by approving or disapproving requests from his personnel for supplies, equipment, and maintenance. The Charles County Sheriff's Office Supply Requisition Form #302 is the controlling document in this process, and will be used for ordering all items other than office supplies, which are stocked by the Quartermaster. Office supplies stocked by the Quartermaster shall be ordered using Office Supplies Request Form #303.

Commanders / directors should monitor for abnormal levels of usage or requests for unusual or never before requested items. In the latter cases, the commander / director must determine what impact approving a request for an item that was not planned for during the budget process, will have upon funds in general. These determinations may cause the commander / director to withhold or delay approval.

Commanders / directors shall cause a report to be made in all cases where Sheriff's Office property, used within their command, is lost, stolen or damaged. A Loss / Damage Report Form #310 shall be used and the process outlined in Section 3-501.1 followed.

**3-302 PURCHASING PROCEDURES**

The Charles County Sheriff's Office has established purchasing and procurement procedures defined by Charles County Code, Chapter 203.

These procedures cover all purchases and procurement for all materials, equipment, supplies, and services over which the Sheriff has expenditure control and responsibility, excluding contracts for professional services and architectural and engineering services, which are set forth in other provisions relating to Charles County.

The Charles County Sheriff's Office has established the Quartermaster to interact with the division commanders / directors or their respective designees to assist with following these procedures.

The Procurement Specialist, located in the Quartermaster's Unit, will communicate with vendors, contractors, and consulting firms regarding bids, requests for proposals (RFP's), equipment, supplies, and services required by the Agency.

Whenever practical, it shall be the policy of the Sheriff's Office to secure adequate competition to assure that the purchase or procurement is made at the lowest possible cost consistent with the quality and delivery requirement

**Administrative and Operational Manual****September 12, 2022**

of the requesting division. Competitive pricing shall be obtained, with at least three (3) price quotes or, if a sole source vendor, with written documentation. This information will be maintained by the Quartermaster's Unit.

The employee requesting the item or expenditure shall complete the Requisition Form #302A, down to and including the "Justification" line. The employee shall submit the form to his commander / director for approval. Commanders / directors shall approve the form by completing the approval line. In cases where the commander / director does not approve the requisition, it will be returned to the originating employee.

All requests for equipment, supplies, repairs, and other expenditure of funds, require the completion of Requisition Form #302A, and will be prepared by the Quartermaster's Office. The following applies:

- all requests be typewritten (handwritten requests will be returned to the requestor);
- one vendor per requisition;
- the quantity needed;
- unit of measure;
- a detailed description of the item or service required;
- name of the vendor, with current address, telephone and fax number, if needed;
- the unit price of the item or service;
- the freight cost of the item or service;
- the budget account number of the funds to be left open;
- notation as to which budget funding will be utilized--Sheriff's Budget, Corrections budget, grant funding, etc.; and
- employees will check with the Quartermaster's Unit for vendor and pricing verification.

When approved, the Requisition Form #302A is forwarded to the Quartermaster to distribute to Quartermaster staff to complete the Requisition Form #302A by securing adequate competition and pricing of the requested item. The form will then be returned to the Quartermaster for review. Quartermaster will then forward the completed packet to the appropriate commander for approval. Upon approval of the Assistant Sheriff, the packet will be forwarded to Deputy Director, Budgeting. If it is not approved, the requisition will be returned to the originating employee through the chain of command.

When Deputy Director, Budgeting receives the requisition, an employee of the section will determine the appropriate budget account number and the availability of funds for the requisition. The Budget Analyst employee will indicate in the appropriate box if funds are available or not and sign the requisition form.

If funds are available, a purchase order will be prepared. The purchase order and requisition will be forwarded to the Commander / Director, Administrative Services for final review and signature. A copy of the signed purchase order and documentation will be forwarded to the Quartermaster. The original purchase order and documentation will be kept on file in the Accounting Clerk for auditing purposes.

If funds are not available, the requisition will be forwarded to the Commander / Director, Administrative Services for final review and disposition.

### **3-303 DOCUMENTATION OF RECEIPT**

All personnel who are authorized to order an approved item and have it delivered directly to their work location will be responsible for the final invoice approval. All personnel shall comply with the following procedures:

- When possible, all items shall be ordered through the Quartermaster's Unit;
- Items ordered by the Quartermaster's Unit will be signed for at the work location where delivered and the receipt forwarded to the Quartermaster for inventory control purposes;
- All property and equipment is subject to be tagged by the Financial Services Section and will be recorded



Administrative and Operational Manual

September 12, 2022

on the Asset / Property Form #766. When Form #766 is completed, it will be forwarded to the Accounting Section, to be recorded in the Fixed Asset / Property records;

- Any item determined an asset by Financial Services will be logged into the division's component asset log;
- Upon receipt of an invoice, Accounting Section personnel will forward it to the Quartermaster for final payment approval; and
- All invoices shall contain an "ok to pay," signature, ID number, and date, and will be returned to the Accounting Section for processing.

The primary responsibility for ensuring this procedure is followed is the requesting individual on the Supply Requisition Form #302, followed by the approving supervisor.

### 3-304 EQUIPMENT REPAIR

Prior to any equipment being repaired (except vehicles covered under another section of this Manual), for which a service contract is not already in place, a Requisition Form #302A shall be submitted to the Quartermaster. The form shall contain on the justification line, if known:

- the problem with the item;
- when the item was purchased;
- cost when purchased; and
- estimated cost to repair.

This data will be used to make a determination whether it is cost effective to have the item repaired or replaced. In the description section of the item line, the Sheriff's Office ID number shall be copied from the tag affixed to the item and placed on the Form #302A.

Nothing in this procedure shall prevent a commander from authorizing repairs or replacement in an emergency or when exigent circumstances exist. In these cases, the commander shall cause a requisition to be completed "after the fact" and forward it with the receipts to the Deputy Director, Budgeting.

### 3-305 CAPITAL AND FIXED AGENCY ASSETS

The CCSO has in resources capital and fixed assets. These assets are assigned to components within the Agency for official Sheriff's Office use. Assets obtained by the Agency will be inventoried and assigned a tracking number issued by the Accounting Section. Items listed as assets include, but are not limited to, office furniture, office equipment, video / photography equipment, and other general or special equipment used to perform Agency functions. Vehicle equipment permanently mounted on a vehicle is excluded. All items with a purchase cost of \$1,000 or more and a useful life of one year or more are required to be inventoried. Those asset items with a cost of less than \$1,000 but having a useful life of one year or more will also be inventoried in order to accurately reflect Agency assets. This includes all items that are donated or purchased via special funding such as grants or lease purchase agreements.

Any property meeting these guidelines acquired by Agency personnel will be documented on an Asset / Property Form #766, and a copy will be forwarded to the Accounting Section, which is responsible to account for all Agency property.

The Quartermaster will prepare a Transfer / Disposal of Assets / Property Form #768 for all items ordered through the Quartermaster's Unit. Fleet Services will prepare Form #768 for all items ordered through Fleet Services. The Corrections Division will prepare Form #768 for all items ordered through their Division. MIS will prepare Form #768 for all items ordered through MIS.

**Administrative and Operational Manual****September 12, 2022****3-306 INVENTORY AND CONTROL OF AGENCY PROPERTY**

The inventory and control of property assigned to an individual employee will be maintained by the issuing authority. All other property designated as capital or fixed assets will be inventoried and controlled in an asset log maintained by the commander / director of each division. A list of capital and fixed assets, excluding vehicles, firearms, and computers, may be obtained from the Deputy Director, Accounting Section. The log will be broken down by components of the division and include the following:

- Agency assigned tracking number (if assigned);
- manufacturer, model and description;
- serial number (if available);
- date received by division or component;
- specific location of item (building, floor, room number).

The commander / director of each division will conduct a bi-annual inventory of his division's assets, computers, and firearms. During the inventory the commander or a designee shall compare the list of capital and fixed assets provided by Deputy Director, Accounting Section, a list of firearms provided by the Commander, Special Services, and a list of computers provided by the Director, ITD with the assets in custody. Commanders will list additional, missing or transferred assets, and correct the inventory sheets to reflect changes in room number, condition, or usage of the asset. Prior to January 15 and June 30 respectively, the commander of each division will prepare a report of his findings and submit it to the Deputy Director, Accounting. The Deputy Director, Accounting will complete an Assets Report, which will be forwarded to the Sheriff. Audits of a division's assets will be conducted by the Accounting Section and Office of Professional Responsibility as described elsewhere in this Manual.

A commander / director, when assuming command of a division, shall inventory the entire division and accept responsibility for all he finds at his disposal within 30 days of a change of command. In a like manner, a commander / director turning over a command, shall inventory his division and formally give an accounting of that which is to be turned over. Discrepancies will be documented immediately and forwarded to the Deputy Director, Accounting. The Deputy Director, Accounting will attempt to resolve the discrepancies. If unable, he shall contact the Assistant Sheriff of Administration.

**3-307 TRANSFER OF AGENCY PROPERTY AND EQUIPMENT**

Agency property and equipment can be transferred between divisions or components with authorization from the division commanders of both the component to which the property is assigned and to which it will be received. Transfer of computers and computer related equipment between divisions / components will be made only under the authority of the Director, Information Technology Division. The transfer of vehicles and weapons will be made only under the authority of the Commander, Special Services Division.

Transfer of equipment other than computers, firearms, and vehicles will be documented on the Transfer / Disposal of Assets / Property Form #768. A copy will be forwarded to the Deputy Director, Accounting, who is responsible to account for all Agency property and equipment, as a part of the County inventory control process. Any transfer of equipment / property within or out of a component from where it was assigned, will be documented on the division's asset log. In the same manner, any property received by a division will be documented in the division's asset log where it will be assigned.

**3-308 TRANSFERS OF EQUIPMENT ASSIGNED TO PERSONNEL**

Equipment assigned to an individual shall not be transferred to another person. The equipment shall be returned to the controlling person, generally the Quartermaster, Commander, Special Services, or Director, ITD, who will record the necessary changes on the equipment custody sheet and return the item to inventory.



Administrative and Operational Manual

September 12, 2022

---

### 3-309 DISPOSAL OF EQUIPMENT, AGENCY PROPERTY, OR ASSETS

On occasion, Agency property or equipment becomes obsolete or unserviceable and not cost effective to repair for a number of reasons.

In these cases, the appropriate division commander or a designee will complete an Asset / Property Form #768 for any asset to be disposed of from the assigned division. Unless disposal can be immediately determined by the Procurement Specialist, the item will be sent to the Quartermaster's Unit for disposal. The person disposing of the property will be responsible for transporting it to the Quartermaster's Unit. The item will be logged out of the asset log for the respective component of the division where the property was assigned.

The Quartermaster will then store the property until the Procurement Specialist makes a determination as to the final disposition.

The Procurement Specialist shall periodically submit, through the Quartermaster, to the Accounting Section, a listing of any supplies and equipment which are no longer used or which have become obsolete or worn out. The listing should include a full description and how, when, and where the item(s) were disposed. The Quartermaster shall cause the Procurement Specialist to consider any value of property to determine the possible use of any surplus by another agency. Proper disposal method will be decided and coordinated within the Quartermaster's Unit.

Section 203-4 of the Charles County Code, which addresses the policies for disposition of surplus property, states the Sheriff is responsible for the disposition of surplus, obsolete, or scrap supplies or equipment under the Sheriff's control. Disposition may be made in any of the following ways:

- request the vendor to substitute for other materials;
- return to supplier for credit;
- outright sale via advertised bid or auction;
- trade-in; or
- scrapping.

No assets, regardless of original or remaining scrap value, may be disposed of without the approval of the Procurement Specialist and Quartermaster, regardless of the method of disposal.

Once the Quartermaster has received written approval to dispose of the asset / property, the item may be disposed of and the Quartermaster's Unit will complete the submitted Form #768. The completed form and the disposal documentation will be forwarded to the Accounting Section. The Accounting Section will remove the record of the property from the Sheriff's Office asset data base.





## Administrative and Operational Manual

September 12, 2022

## 3-500 UNIFORMS AND EQUIPMENT

The Agency provides uniforms to some employees to use in the performance of their duties. All personnel have at their disposal at least a limited amount of Charles County Sheriff's Office property to be used for, or to facilitate, the performance of their duties. All of these uniforms, equipment, and other CCSO property, must be used and accounted for in the manner prescribed in this Manual, and in supplemental documents and instructions issued by the Agency and its supervisory personnel.

### 3-501 PERSONALLY OWNED EQUIPMENT

The rules promulgated for the control of uniforms, equipment, and property, apply equally to items owned by the employee, and allowed or required, by the Agency, to be used in the performance of the employee's duties. In this regard, the use is controlled and not the property. The Agency does not intend to infringe upon any property right of the employee, but instead, to regulate the performance of the employee regarding his job while using individually owned property.

#### 3-501.1 LOSS OR DAMAGE OF PERSONAL PROPERTY AND EQUIPMENT

The Agency may provide some compensation for the loss or damage of personally owned property, if that loss or damage occurred as a result of the performance of the employee's duties. The Agency does not guarantee compensation. However, if the requirements of this section are met, some compensation may be awarded. In order to qualify for compensation, the following conditions must be met.

- The loss must be directly related to the particular employee's specific duties; or
- The employee must be performing some function related to an urgent situation which may not be directly related to the employee's duties, but is a responsibility or expectation of the Agency in general.

**Example:** If an officer was attacked by a person in a district station, and the police station technician, in coming to the aid of the officer, had a pair of glasses broken, the broken glasses would qualify for compensation. Even though the restraint of a person is not within the job description of a police station technician, there is clearly an expectation of assistance to another employee in need of help performing the other employee's duties.

- An employee must also have taken reasonable care to avoid placing valuable personal property in harm's way, in order to qualify for reimbursement.

**Examples:** Employees who work in an environment where they are exposed to dirt, chemicals, body fluids and the like, should wear protective clothing; or

Employees should not wear expensive watches, necklaces or other adornments, given the risk of confrontational situations associated with Sheriff's Office duties.

In all cases, an evaluation will be made, as in the case of Agency property, concerning any employee negligence which may have contributed to the loss. If it is determined that employee negligence was the cause of the loss, no reimbursement will be provided.



Administrative and Operational Manual

September 12, 2022

### 3-501.1.1 DEFINITIONS: LOST AND DAMAGED

**Lost** - a personal item will be considered lost and the employee may apply for reimbursement if:

- a reasonable attempt was made to locate the item, or
- the item is damaged and cannot be repaired, or
- the repair cost of the item is greater than the maximum available reimbursement.

**Damage** - an item will be considered damaged if the item can be repaired for less than the available reimbursement.

### 3-501.1.2 REPAIR / REPLACEMENT LIMITS

The following repair / replacement limits apply to all cases where a claim is made for reimbursement of a case of personal property lost or damaged in the course of an employee's duties.

- In no event will an employee be reimbursed more than three hundred dollars (\$300.00) for the repair or replacement of any personal property item.
- Employees will not be provided compensation for an item for which an insurance claim is satisfied from any source.
- Items which the employee chooses to carry in place of an issued item are specifically excluded from reimbursement. However, supplemental items personally owned by the employee such as handcuffs, flexcuffs, cold weather gear, extra flashlights or similar items will be considered on a case-by-case basis.
- Items which an employee chooses to carry which have no application to the employee's employment tasks are specifically excluded from reimbursement.

### 3-501.1.3 PROCEDURE FOR REIMBURSEMENT

Employees who wish to document lost or damaged personal property covered under this section shall complete CCSO Form #310A Report of Lost/Damaged Personal Property. The employee must specifically request reimbursement by checking the appropriate block on the form. The completed form will be submitted to the Division Commander through the chain of command.

## 3-502 DUTY TO CARE FOR AGENCY EQUIPMENT AND PROPERTY

All Agency property / equipment including weapons shall be maintained in a state of operational readiness by the person or unit to which the property is assigned. Employees are responsible for the care, security, and proper maintenance of all Agency equipment or property that is issued to them. This equipment will not be used in a negligent manner. Employees who are assigned items requiring scheduled maintenance will ensure compliance with such schedules. Operational readiness of equipment / property will be checked during regularly established Agency inspections.

An employee may be held responsible for the uniforms, motor vehicles, equipment, or other property, which is issued to, or is used or controlled by the employee as a result of employment with the Charles County Sheriff's Office. Where it is established that this property is lost or damaged through negligence, the employee concerned may be obligated to replace it at his own expense. Every employee of the Agency shall assume a personal responsibility for all property issued to him, or placed in service for his use or convenience.



**Administrative and Operational Manual**

**September 12, 2022**

**3-503 LOSS OR DAMAGE TO PROPERTY**

The procedures and reports required by this section apply to all cases of loss or damage to equipment or other Charles County Sheriff's Office property, except damage to an Agency vehicle. Any damage to an agency vehicle shall be reported using the established procedures in section 6-601 of this manual.

**3-503.1 RESPONSIBILITY TO REPORT**

Any employee who has knowledge of the occurrence of loss or damage to Charles County Sheriff's Office property shall report that occurrence to a supervisor. Any employee charged with the custody of Agency property which becomes lost or damaged is responsible to make an official report using either CCSO Form #310 Report of Lost or Damaged Agency Property or, for an Agency vehicle, CCSO Form #843 Report of Agency Vehicle Damage immediately upon learning of the occurrence. Supervisors who learn of any loss or damage to Charles County Sheriff's Office property shall notify the employee who is responsible for the property and ensure the completion of either the CCSO Form #310 or CCSO Form #843.

**3-503.2 FORM COMPLETION**

The employee responsible for the property, or in the case of an employee who is incapable of completing the report, the employee's supervisor, will complete the appropriate sections of the CCSO Form #310 in the case of lost property. In the case of a damaged Agency vehicle, the employee's supervisor or assigned investigator will complete the CCSO Form #843. An employee submitting a CCSO Form #310 will, in most cases, then submit the form to his supervisor. In those cases where there was an on-scene investigation by someone other than the employee's supervisor, the form will be submitted to the on-scene investigator to the Division Commander through the chain of command.

The supervisor of the employee responsible for the property shall complete the second section (Supervisor Investigation and Conclusion) on the back of the Form #310. The supervisor is required, in this section, to make a judgment, based upon his review of the information contained in the report, and any statement made by the employee, concerning negligence and loss/damage preventability. If the supervisor finds it necessary to question a sworn employee in order to make a determination of negligence, the employee shall be properly questioned under the provisions of the LEOBR (Public Safety Code Volume).

The division commander / director of the responsible employee shall review the Form #310 and acknowledge their review by signing the form. Nothing in this policy section prohibits the division commander / director from initiating immediate corrective, remedial, or other action as the commander / director, in his discretion, deems appropriate.

The division commander responsible for the management of the loss or damage shall arrange for an immediate replacement / repair and will note on the Form #310 replacement / repair disposition. Should the item(s) require payment to the employee for replacement, the division commander will ensure a Form #302A is submitted with attached documentation showing how the payment amount was calculated along with a copy of the completed Form #310.

**3-504 QUARTERMASTER RESPONSIBILITIES**

The Agency Quartermaster is charged with the procurement, warehousing, and disbursement of Agency uniform and equipment items. He is also charged with the keeping of files establishing the proper flow of items which come into his keeping as a result of his duties. In that regard, the Quartermaster will establish individual files for every eligible employee. Whenever an employee completes any transaction with the Quartermaster under this system, a record of that transaction will be made in the employee's Quartermaster file. In the event a transaction cannot be completed (e.g., when an item is not in stock), a record of the partial transaction will be kept in a suspense or

**Administrative and Operational Manual****September 12, 2022**

pending file. When the transaction is complete, the record will be made in the Quartermaster's permanent file.

If an item needed by an employee for replacement of an unserviceable item is not in stock, the employee may still turn in the unserviceable item. The Quartermaster will then notify the employee when the replacement item is in stock in order that the employee may pick up the item.

### **3-505 REPLACEMENT OF ITEMS WHICH BECOME UNSERVICEABLE THROUGH NORMAL USE**

An item is considered unserviceable when the item(s):

- is damaged;
- is not working as designed or intended;
- is sized incorrectly;
- continued use would pose a health risk to the employee or public;
- continued use of the item would reflect poorly upon the image of the Agency;
- is soiled to the degree normal cleaning is insufficient.

If an employee believes an issued item has become unserviceable, the employee shall respond to the Quartermaster's Office for replacement. The employee shall present the unserviceable item to the Quartermaster's Office for replacement. The Quartermaster shall make a determination as to whether the item is unserviceable. If the item is deemed unserviceable, the Quartermaster shall replace the item. If the Quartermaster determines the item is serviceable and there is a disagreement regarding the items status, the Commander, Property Management shall make the final determination of the items serviceability.

The Quartermaster shall pay particular attention to items that are presented for replacement within two years of issuance.

#### **3-505.1 REPLACEMENT OF LOST, STOLEN OR EMPLOYEE DAMAGED ISSUED ITEMS**

As stated above in 3-505, an employee must turn in an unserviceable item to receive another like item (one for one trade). If the employee lost the item, the item was stolen or the item was damaged through negligence of the employee, the employee shall present a completed form #310 to the Quartermaster for replacement of the lost, stolen or damaged item.

#### **3-505.2 REPLACEMENT OF EXPENDABLE ITEMS**

An expendable item is:

- crime scene tape
- CPR mask
- fingerprint dust
- emergency blanket
- expectorant shield
- personal protective kit
- gloves
- tourniquet
- surgical mask



## Administrative and Operational Manual

September 12, 2022

An officer in need of replacement of an expendable item need not exchange an unserviceable item or complete a form #310 to receive a replacement item.

### 3-510 WEAR AND DISPLAY OF UNIFORMS

Uniforms will be worn in their entirety and in intended fashion. Uniforms shall be clean and serviceable, and shall not display excessive wear. All buttons on uniforms shall be buttoned, except that the collar button on shirts shall be unbuttoned when the tie is not worn. Brass items are polished, with lettering blackened; snaps and buttons are fastened where intended.

Commissioned officers may optionally wear the duty firearm on the Garrison belt, in lieu of wearing the Sam Browne belt. Other items normally worn on the Sam Browne belt may be worn, as needed, on the Garrison belt, when the Sam Browne belt is not worn.

Uniform articles shall not be worn with civilian clothing articles, except for incidents where an authorized identification item is used, or at the range.

Employees will wear, use, and display only uniform or equipment items that are authorized by regulations. Uniform and/or equipment items approved for temporary use by a division commander, for specific assignments, will also be permitted. Division commanders shall not permit use of items prohibited by this Manual or other Agency directives, except in extreme exigent circumstances. The commander shall, in those instances, report such approval to the Assistant Sheriff of Administration, in writing, within 24 hours of such approval being granted.

### 3-511 UNIFORM CLEANING AND MAINTENANCE EXPENSE

All employees who are issued uniforms and personally assigned equipment by the Agency, for use in performing their duties, shall clean and maintain those items. Some employees are provided funds for that purpose according to the following schedule (employees covered by a formal MOU dealing with this item will refer to the MOU for exact details, as this section pertains only to those not so covered):

- full-time, reduced hours, court security officers shall receive eighty-seven dollars fifty cents (\$87.50) per quarter (\$350 annually).
- part-time court security officers shall receive fifty seven dollars fifty cents (\$57.50) per quarter (\$230 annually).
- cadets and civilian forensic science technicians shall receive fifty dollars (\$50.00) each year (July).

#### Automated Enforcement Unit (AEU):

- full-time sworn officers shall receive eighty-seven dollars fifty cents (\$87.50) per quarter (\$350 annually);
- full-time civilian AEU Supervisor shall receive fifty dollars (\$50.00) per quarter (\$200 annually).

These funds are provided each quarter, in advance, based upon which of the above listed categories the employee falls within on the first working day of the quarter. The actual distribution of funds occurs during the first two weeks of the quarter, dependent upon how the current pay period ends. Quarters begin January, April, July, and October each year.

It is important to note that funds distribution is based upon actual work assignment. For example, new sworn officers who are wearing an Academy uniform instead of the sworn officer's uniform are not entitled to the sworn uniform maintenance and cleaning expense payment. Also, an employee who has not been in a duty status, for fifty percent



**Administrative and Operational Manual**

**September 12, 2022**

---

or more of the preceding quarter, is not entitled to the uniform maintenance and cleaning expense for the following quarter.

Any cleaning and maintenance necessary, which exceeds the amount provided for in this section, shall be at the employee's own expense, unless covered by a policy elsewhere in this Manual.

**3-512 EXCHANGE AND REPLACEMENT OF UNIFORM AND EQUIPMENT ITEMS**

Uniform and equipment items which become unserviceable as a result of normal wear or as a result of legitimate work activities of the employee, will be exchanged with the Quartermaster at no expense to the employee.

New employees who are required to wear uniforms in the performance of their duties, receive an original uniform issue at the Agency's expense. Items which must be replaced due to an Agency required change in rank or assignment are issued at the Agency's expense. If an employee, because of a change in weight or size, can no longer wear a particular uniform item, that item may be exchanged with the Quartermaster for another. Nothing in this policy shall require the Quartermaster to issue or replace items as new. Any serviceable item may be issued, by the Quartermaster, for use by employees.

When an employee who has been issued clothing and equipment by the Agency, leaves employment with the Agency, that employee shall return the clothing and property issued.

**3-513 DISPOSAL OF UNSERVICEABLE UNIFORM ITEMS**

Agency issued items which become unserviceable must be returned to the Quartermaster for disposal.



Administrative and Operational Manual

September 12, 2022

3-520 ORIGINAL ISSUE – UNIFORMS AND EQUIPMENT

Each employee who is required to wear a uniform shall be issued a set of uniforms and equipment. This set of uniforms and equipment shall be in accordance with the lists in this chapter for the employee’s position. This list, referred to as “original issue,” shall be maintained in serviceable condition at all times. The original issue shall be turned in to the Quartermaster when the employee is about to leave employment with the Agency.

3-520.1 ORIGINAL ISSUE - SWORN OFFICERS

- Agency lanyard and cardholder (HR to issue)..... 1
- ammunition, handgun (box of 50 rounds) ..... 1
- armor, soft body panels w/ 2 carriers..... 1
- badge, pistol marksmanship ..... 1
- badge, police (domed) ..... 2
- ball cap..... 1
- badge case, multi-use, engraved ..... 1
- belt, Garrison..... 1
- belt, Sam Browne ..... 1
- belt clip, portable radio..... 1
- blouse, dress (see Section 535 of this Chapter) ..... 1
- cap, baton..... 1
- case, handcuff ..... 1
- charger, portable radio ..... 1
- coat, rain..... 1
- collapsible baton ..... 1
- collar brass (set of 3) ..... 2
- cover, hat (rain)..... 1
- handcuffs..... 1
- handgun ..... 1
- hat, black knit..... 1
- hat, felt ..... 1
- hat, straw..... 1
- holder, collapsible baton ..... 1
- holder, magazine..... 1
- holder, OC spray..... 1
- holder, portable radio ..... 1
- holster, paddle, pancake..... 1
- holster, duty..... 1
- jacket, Gortex patrol..... 1
- keepers, belt..... 4
- magazine, handgun ..... 3
- mock turtle neck dickie..... 2
- nameplate (brass)..... 2
- OC spray..... 1
- pin, CALEA Accreditation..... 2
- pouch, magazine / handcuff..... 1
- radio, portable..... 1
- ribbon, U. S. Flag..... 2
- shield, expectorant..... 1
- shirts (white long sleeve Lt. and above)..... 3
- shirts (white short sleeve Lt. and above) ..... 3
- shirts (brown long sleeve Sgt. and below)..... 3



Administrative and Operational Manual

September 12, 2022

- shirts (brown short sleeve Sgt. and below)..... 3
- shirts, BDU (long sleeve)..... 3
- shirts, BDU (short sleeve)..... 3
- strap, portable radio..... 1
- sweater (optional)..... 1
- ties, taupe..... 3
- trigger lock..... 2
- trousers..... 3
- trousers, BDU..... 3
- vest, traffic safety..... 1
- whistle..... 1

**3-520.1.1 ORIGINAL ISSUE – SWORN OFFICERS – TRUNK KIT**

After graduating from the Academy, each officer will be issued the following as part of their vehicle trunk kit:

- Stop Sticks..... 1
- Fingerprint Kit..... 1
- Fire Extinguisher..... 1
- CPR Mask and Case..... 1
- Evidence Collection Kit..... 1
- Fiberglass Measuring Tape..... 1
- First Aid Kit..... 1
- Disposable Blankets..... 2
- Personal Protection Kit..... 1
- Lockout Tool Kit, Easy Glo..... 1

**3-520.2 ORIGINAL ISSUE - COURT SECURITY OFFICERS**

- Agency lanyard and cardholder (HR to issue)..... 1
- ammunition, handgun (box of 50 rounds) ..... 1
- armor, soft body with 2 carriers ..... 1
- badge, pistol marksmanship..... 1
- badge, domed..... 2
- ball cap..... 1
- belt, Garrison..... 1
- belt, Sam Browne ..... 1
- cap, baton..... 1
- case, handcuff ..... 1
- coat, rain..... 1
- collapsible baton ..... 1
- collar brass (set of 3) ..... 1
- handcuffs..... 1
- handgun ..... 1
- holder, collapsible baton ..... 1
- holder, magazine ..... 1
- holder, OC spray..... 1
- holster, duty..... 1
- jacket, Gortex patrol..... 1
- keepers, belt..... 4





Administrative and Operational Manual

September 12, 2022

- magazine, handgun ..... 3
- nameplate (brass)..... 2
- OC spray ..... 1
- pin, CALEA Accreditation..... 2
- ribbon, U. S. Flag..... 2
- shield, expectorant..... 1
- shirts, (long sleeve)..... 3
- shirts, (short sleeve)..... 3
- strap, portable radio..... 1
- sweater (optional)..... 1
- ties, taupe..... 3
- trigger lock..... 2
- trousers..... 3

**3-520.3 ORIGINAL ISSUE - CORRECTIONAL OFFICERS**

- Agency lanyard and cardholder (HR to issue) ..... 1
- badge, Corrections ..... 2
- ball cap ..... 1
- belt, Garrison ..... 1
- belt clip, portable radio ..... 1
- case, handcuff..... 1
- collar brass (set of 3)..... 2
- emergency response kit ..... 1
- handcuffs ..... 1
- hat, black knit..... 1
- holder, OC spray ..... 1
- jacket, Gortex patrol ..... 1
- mock turtle neck dickie ..... 2
- nameplate (brass) ..... 2
- OC spray..... 1
- pin, CALEA Accreditation ..... 2
- ribbon, U. S. Flag ..... 2
- shirts, (long sleeve) ..... 2
- shirts, (short sleeve) ..... 2
- shirts (white long sleeve Lt. and above)..... 3
- shirts (white short sleeve Lt. and above)..... 3
- shirts, BDU (long sleeve) ..... 3
- shirts, BDU (short sleeve)..... 3
- sweater (optional)..... 1
- ties, taupe ..... 2
- ties, black (Lt. and above)..... 2
- trousers..... 2
- trousers (Lt. and above)..... 3
- trousers, BDU..... 3

**3-520.4 ORIGINAL ISSUE - POLICE COMMUNICATIONS OFFICERS**

- Agency lanyard and cardholder (HR to issue) ..... 1
- Agency short sleeve polo shirt ..... 4
- pin, CALEA Accreditation ..... 1



Administrative and Operational Manual

September 12, 2022

**3-520.5 ORIGINAL ISSUE - CROSSING GUARDS**

- Agency lanyard and cardholder (HR to issue)..... 1
- badge, crossing guard..... 1
- ball cap ..... 1
- batteries, size D..... 6
- belt, Garrison..... 1
- coat, rain..... 1
- collar brass (set of 3)..... 1
- first aid kit..... 1
- flashlight, with wand..... 1
- gloves, white (pair)..... 2
- jacket, Gortex patrol..... 1
- kit, personal protection..... 1
- LED light..... 1
- nameplate (brass)..... 2
- pin, CALEA Accreditation..... 1
- ribbon, U. S. Flag..... 2
- shirts (long sleeve)..... 2
- shirts (short sleeve)..... 2
- tie (black)..... 1
- trousers..... 2
- vest, traffic safety..... 1
- whistle ..... 1

**3-520.6 ORIGINAL ISSUE - CIVILIAN FORENSIC SCIENCE PERSONNEL**

- Agency lanyard and cardholder (HR to issue)..... 1
- ball cap ..... 1
- belt, Garrison..... 1
- coat, rain..... 1
- jacket, Gortex patrol ..... 1
- nameplate ..... 2
- pin, CALEA Accreditation..... 1
- radio, portable with strap..... 1
- ribbon, U. S. Flag..... 2
- shirts, BDU (long sleeve)..... 5
- shirts, BDU (short sleeve)..... 5
- trousers, BDU..... 5
- vest, traffic safety..... 1
- vest, ballistic, w/plates and outer tactical carrier..... 1

All civilian Forensic Science Section personnel shall wear the BDU exclusively. Except for an immediate summons to court, without advance notice, the civilian court attire (see Chapter 3, Section 594) shall be worn to court.

**3-520.7 ORIGINAL ISSUE – CADETS**

- Agency lanyard and cardholder (HR to issue)..... 1



Administrative and Operational Manual

September 12, 2022

- armor, soft body with 2 carriers..... 1
- badge, Cadet..... 2
- ball cap ..... 1
- belt, Garrison..... 1
- coat, rain..... 1
- collar brass (set of 3)..... 1
- hat, black knit..... 1
- holder, portable radio..... 1
- jacket, Gortex patrol..... 1
- nameplate (brass)..... 1
- patches, Cadet..... 13
- pin, CALEA Accreditation..... 1
- radio, portable (Communications to issue)..... 1
- ribbon, U. S. Flag..... 1
- shirt, black Agency polo, with Agency patch..... 3
- shirts (long sleeve, silver tan)..... 1
- shirts (short sleeve, silver tan)..... 1
- shirts, BDU (long sleeve)..... 1
- shirts, BDU (short sleeve)..... 1
- strap, portable radio (Communications to issue)..... 1
- tie (black)..... 1
- trousers, pink tan..... 1
- trousers, BDU..... 1
- vest, traffic safety, CADET..... 1

Cadet patches shall be worn on all uniform items displaying the Agency shoulder patch. The Cadet patch shall be worn centered 1/4 inch below the Agency shoulder patch.

**3-520.8 ORIGINAL ISSUE - COURTHOUSE SECURITY AIDES**

- Agency lanyard and cardholder (HR to issue)..... 1
- ball cap..... 1
- blazer ..... 2
- collar brass (set of 3)..... 1
- nameplate, pocket..... 1
- pin, CALEA Accreditation..... 1
- ties (black)..... 2
- trousers ..... 3
- vest, ballistic w/two concealable carriers (white)..... 1

Courthouse Security Aides, when on-duty, will wear the original Agency issued attire in its entirety. Additionally, Courthouse Security Aides will provide and wear a light colored, plain dress shirt and black, business / dress type shoes.

**3-520.9 ORIGINAL ISSUE - CIVILIAN PERSONNEL**

- Agency lanyard and cardholder..... 1
- pin, CALEA Accreditation..... 2

Civilian personnel working in sections where they are required to wear a uniform (ITD, Communications, police station technicians) will be also issued:

- Agency short-sleeve polo shirt:



Administrative and Operational Manual

September 12, 2022

Full-time employees..... 4  
 Part-time employees.....3

The Agency Facility Maintenance Manager will also be issued:

- Ball cap.....1

**3-520.10 ORIGINAL ISSUE – CITIZEN’S POLICE ACADEMY ALUMNI**

- Shirt, black Agency polo (short sleeve, with CPA badge patch)..... 1

**3-520.11 ORIGINAL ISSUE – CHAPLAIN SERVICES**

When an individual is assigned to Chaplain Services within CCSO, the following items shall be issued:

- Agency lanyard and cardholder (HR to issue)..... 1
- badge, Chaplain..... 1
- badge wallet..... 1
- ball cap ..... 1
- blazer, pocket ID.....1
- jacket, Gore-Tex®.....1
- jacket, raid..... 1
- nameplate (brass)..... 1
- patches, round CCSO civilian patches..... 4
- patches, embroidered “Chaplain” for shirts..... 4
- photo ID (HR to issue)..... 2
- vest, traffic safety..... 1

Flares are available as needed. Requests for flares should be made to the Commander, Executive Services Division.

Chaplains will return all issued items when they are no longer assigned to Chaplain Services.

**3-521 SUPPLEMENTAL ISSUE OF UNIFORMS AND EQUIPMENT**

When personnel are assigned to duties which require the use of specialized uniforms and equipment, they will receive a supplemental issue as outlined in the following sections. These uniform and equipment items are to be maintained in addition to, and not in place of, other issued uniform and equipment items. **Unless authorized elsewhere in the AOM, supplemental issue uniforms and equipment shall be returned to the Quartermaster when the employee leaves the assignment for which they were issued.** No employee shall wear any of the supplemental uniforms or equipment unless that employee has been issued them as a result of his work assignment. Supplemental uniforms and equipment shall only be worn or used in accordance with the policies in this Manual and/or unit SOPs. They shall be of a manufacturer, make, model, or style, and color as authorized by an Assistant Sheriff and approved by the Sheriff. The Quartermaster’s authorization to issue supplemental uniforms shall require a confirmation of assignment.

No employee will receive duplicate items as directed by a supplemental issue if the employee has previously received the authorized items via an original or other supplemental issue.



Administrative and Operational Manual

September 12, 2022

**3-521.1 SUPPLEMENTAL ISSUE – SWORN FORENSIC SCIENCE SECTION**

When a current sworn officer is assigned to the Forensic Science Section, the following supplemental items shall be issued:

- ball cap ..... 1
- shirts, BDU (long sleeve) ..... 2
- shirts, BDU (short sleeve) ..... 2
- trousers, BDU ..... 1
- vest, ballistic w/hard plate and outer tactical carrier.....1

The utility uniform / BDU will display the authorized collar brass, but a tie or tie tack will not be worn. The utility uniform / BDU shirt will have shoulder patches. Sworn personnel will display rank insignia and a sewn-on badge patch. The issued holster and handgun may be worn on the Garrison belt along with other items from the Sam Browne belt which may be needed.

Coveralls or a lab coat may be worn over the uniform, in situations where it is necessary to protect the uniform. In cases where it is necessary to wear coveralls or lab coat, the tie and tie tack need not be worn.

The ball cap may be worn instead of the winter felt or summer straw hat, when the utility uniform / BDU is worn. A hard hat may be worn in place of the ball cap in situations where safety dictates its wearing.

Except for an immediate summons to court, without advance notice, the sworn basic or dress uniform shall be worn to court. Any of the above policy may be modified by the division commander or designee, in order to comply with the necessities of a particular covert operation in which Forensic Science personnel may be required to participate.

**3-521.2 SUPPLEMENTAL ISSUE - K-9 OFFICERS**

When a current sworn officer is assigned to K-9 duties, the following supplemental items shall be issued:

- ball cap ..... 1
- belt, duty (nylon) ..... 1
- belt keepers (nylon) ..... 4
- belt, pants (nylon) ..... 1
- boots, black plain toe, 8" - 12" uppers with lace / zipper closure ..... 1
- carrier, black outer ..... 1
- case, handcuff (double) (nylon) ..... 1
- case, magazine (double) (nylon) ..... 1
- gun light..... 1
- holder, baton (nylon) ..... 1
- holder, OC spray (nylon) ..... 1
- holder, radio (nylon) ..... 1
- holster, leg ..... 1
- jacket, flight ..... 1
- shirts, BDU (long sleeve) ..... 6
- trousers, BDU ..... 6

A ball cap with Agency and K-9 logos may be worn by the K-9 officer provided the cost is incurred by the officer. K-9 officers will return all supplemental issues when they are no longer assigned to the K-9 Unit.

**3-521.3 SUPPLEMENTAL ISSUE - EST TEAM**



Administrative and Operational Manual

September 12, 2022

When a current sworn officer is assigned to EST Team duties, the following supplemental items shall be issued:

- belt, duty (nylon) ..... 1
- belt, keepers (nylon) ..... 4
- belt, pants (nylon) ..... 1
- boots, black plain toe, 8" - 12" uppers with lace/zipper closure (not to exceed \$250) ..... 1
- case, handcuff, double (nylon) ..... 1
- case, magazine, double (nylon)..... 1
- gloves (pair)..... 1
- handgun (with tactical light attached) ..... 1
- handgun, magazines..... 3
- holder, baton (nylon) ..... 1
- holder, OC spray (nylon) ..... 1
- holder, radio (nylon) ..... 1
- holster (leg) ..... 1
- jacket (flight) ..... 1
- magazine pouch (black nylon)..... 1
- shirt, BDU (long sleeve) ..... 2
- trousers, BDU ..... 2
- vest, tactical ballistic ..... 1

**3-521.4 SUPPLEMENTAL ISSUE - MOTORCYCLE OFFICERS**

When a current sworn officer is assigned to motorcycle duties, the following supplemental items shall be issued:

- belt, Sam / Sally Browne ..... 2
- boots, riding (black) (first pair) ..... 1
- breeches, motorcycle ..... 5
- gloves, motorcycle (pair) ..... 1
- helmet ..... 1
- holder, ASP baton..... 2
- holder, handcuff..... 2
- holder, magazine ..... 2
- holder, radio..... 1
- holster, handgun ..... 2
- jacket, flight ..... 1
- jacket, rain ..... 1
- jacket, leather ..... 1
- pants, rain..... 1
- eyewear, clear ANSI safety glasses ..... 1
- vest, traffic ..... 1

Motorcycle Unit officers will return all supplemental issues when they are no longer assigned to the Motorcycle Unit.

**3-521.5 SUPPLEMENTAL ISSUE - CORRECTIONS ERT TEAM**

When a current Corrections officer is assigned to Corrections ERT Team duties, the following supplemental items shall be issued:

- belt, duty (nylon) ..... 1
- belt keepers (nylon) ..... 4
- belt, pants (nylon) ..... 1



Administrative and Operational Manual

September 12, 2022

- boots (pair) ..... 1
- case, handcuff (nylon)..... 1
- handcuffs..... 1
- holder, OC spray (nylon) ..... 1
- OC spray ..... 1
- shirt, BDU (long sleeve) ..... 5
- trousers, BDU ..... 5
- ERT pin ..... 1

ERT officers will return all supplemental issues when they are no longer assigned to ERT.

**3-521.6 SUPPLEMENTAL ISSUE - CORRECTIONS TRANSPORT OFFICERS**

When a current Corrections officer is assigned to Corrections transport duties, the following supplemental items shall be issued:

- armor, ballistic ..... 1
- baton, collapsible ..... 1
- baton cap..... 1
- belt, duty..... 1
- case, handcuff ..... 1
- coat, rain..... 1
- holster, duty ..... 1
- holder, baton..... 1
- holder, magazine ..... 1
- holder, OC spray..... 1
- keepers, belt..... 4
- OC spray ..... 1

**3-521.7 SUPPLEMENTAL ISSUE - TRAINING ACADEMY STAFF**

Agency uniformed employees (sworn and corrections), assigned to the Southern Maryland Criminal Justice Academy as staff members shall receive the following supplemental uniform items:

- blouse, dress (unless previously issued) ..... 1
- hat, felt ..... 1

Unless otherwise authorized by the AOM, corrections officers, upon completing their assignment at the SMCJA, must return all supplemental issued items to the Agency Quartermaster.

**3-521.8 SUPPLEMENTAL ISSUE - TRAINING ACADEMY**

An employee who moves from a uniform position, i.e., Corrections or Police Communications Officer, or a new recruit attending the Academy, in training as a sworn officer, shall receive a supplemental issue consisting of:

- belt, utility ..... 1
- pants, utility..... 3
- shirts, utility ..... 3

This is a one-time issue which shall be integrated with the employee's original issue. Unlike other supplemental issues, this issue need not be turned in to the Quartermaster at the completion of Academy attendance.



Administrative and Operational Manual

September 12, 2022

The Quartermaster will supply each officer sent to Academy training with the proper uniform, as required by the Academy, to be used during training. This uniform is not a part of original issue and is considered no longer serviceable at the completion of training. Officers who do not complete training are required to return such uniforms to the Quartermaster upon leaving the training program.

New recruit officers who are scheduled to attend the Corrections/ Police Academy are required by SMCJA to purchase specific personal items needed for training, which will be reimbursed up to a maximum of \$700. Receipts will be submitted to the CCSO training officer assigned to the Academy, who will complete a Requisition Form #302A for reimbursement for each officer. The requisition will be forwarded up the chain of command and submitted to the Accounting Section for reimbursement.

**3-521.9 SUPPLEMENTAL ISSUE - AGENCY FIREARMS INSTRUCTORS**

The following additional items will be issued to Agency personnel who function as firearms instructors within the Agency:

- ball cap ..... 1
- shirt, short-sleeve polo pullover with either Agency star (sworn instructors) or civilian patch (civilian instructors):
  - full-time employees ..... 5
  - part-time employees ..... 3
- sweatshirt, hooded pullover with hand warmer pocket ..... 1

An optional long-sleeve polo pullover with either Agency star (sworn instructors) or civilian patch (civilian instructors) is approved for wear and is provided at the employee's expense.

**3-521.10 SUPPLEMENTAL ISSUE - TRAFFIC OPERATIONS OFFICERS**

A ball cap with Agency and Traffic Operations logos may be worn by an officer assigned to Traffic Operations provided the cost is incurred by the officer.

**3-521.11 SUPPLEMENTAL ISSUE - NARCOTICS DETECTIVES**

When a current sworn officer is assigned to Narcotics Unit duties, the following supplemental items shall be issued:

- belt, duty (nylon)..... 1
- belt, pants (nylon)..... 1
- belt, keepers (nylon)..... 4
- carrier, black outer vest ..... 1
- case, handcuff (double, nylon)..... 1
- case, magazine (double, nylon) ..... 1
- holder, baton (nylon) ..... 1
- holder, OC spray (nylon) ..... 1
- holder, radio (nylon) ..... 1
- holster, leg or regular, based on officer preference ..... 1

Narcotics officers will return all supplemental issues when they are no longer assigned to the Narcotics Unit.





Administrative and Operational Manual

September 12, 2022

**3-521.12 SUPPLEMENTAL ISSUE - SWORN OFFICERS - CRIMINAL INVESTIGATIONS DIVISION AND JUDICIAL SERVICES SECTION**

All full-time sworn officers assigned to the Criminal Investigations Division and Judicial Services Section will be issued the following item to be worn at the discretion of their respective commanders:

- carrier, black outer vest..... 1
- jacket, raid (Agency designed) ..... 1

**3-521.13 SUPPLEMENTAL ISSUE – SECURITY RESPONSE VESSEL FUNCTION OPERATORS**

The following additional items will be issued to Agency personnel who function as members of the Security Response Vessel Function:

- shirt, polo pullover (short sleeve with patches and badge sewn on; rank displayed on sleeves) ..... 3
- shirt, BDU (long sleeve)..... 2
- trousers, BDU ..... 2
- belt, nylon garrison ..... 1
- belt, nylon Sam Browne ..... 1
- case, nylon double handcuff..... 1
- case, nylon double magazine..... 1
- holder, nylon baton ..... 1
- holder, nylon OC Spray..... 1
- holster, nylon leg..... 1
- lanyard, tactical..... 1
- keepers, nylon belt..... 4

**3-521.14 SUPPLEMENTAL ISSUE – BICYCLE UNIT**

The following additional items will be issued to Agency personnel who function as members of the Bicycle Unit:

- Bike Shirt, Polo Pullover (Short sleeve with patches and badge sewn on)..... 2
- Bike Pants / Shorts..... 2
- Bike Windbreaker / Jacket..... 1
- Belt, Nylon Garrison..... 1
- Belt, Sam Browne (Nylon)..... 1
- Case, Double Handcuff (Nylon)..... 1
- Case, Double Magazine (Nylon)..... 1
- Helmet, bike..... 1
- Holder, Baton (Nylon)..... 1
- Holder, OC Spray (Nylon)..... 1
- Belt Keepers, (Nylon) ..... 4
- Holder, Radio (Nylon)..... 1
- Holster, Duty..... 1

All supplemental issue items will be issued prior to Bicycle Unit training, with the exception of the bike shirt and bike pants. Only one each will be issued prior to training. Upon successful completion of training, the second shirt and pants will be issued. Bicycle Unit officers will return all supplemental issues when no longer assigned to the Bicycle Unit.



Administrative and Operational Manual

September 12, 2022

**3-521.15 SUPPLEMENTAL ISSUE - HONOR GUARD (Effective: 1/26/18)**

When an officer is assigned to Honor Guard duties, the following supplemental items shall be issued after the successful completion of initial training:

- Agency awards ..... 1
- badge, Honor Guard..... 1
- badge, pistol marksmanship..... 1
- belt, Sam Browne (patent leather)..... 1
- blouse, dress..... 1
- case, handcuff w/hidden snap (patent leather)..... 1
- collar brass (set of 3)..... 2
- cover, hat (rain)..... 1
- garment / dress blouse bag (black)..... 1
- gloves, white (pair, w/non-slip grip and Velcro wrist strap)..... 1
- hat, felt (with patent leather straps)..... 1
- holder, double magazine w/hidden snaps (patent leather)..... 1
- holster (patent leather)..... 1
- jacket, rain (black w/Agency patches)..... 1
- nameplate (brass)..... 1
- pin, CALEA Accreditation..... 1
- pin, Honor Guard..... 1
- pin, U.S. Flag..... 1
- shirt (long sleeve white)..... 1
- shoes (patent leather w/taps as needed)..... 1
- shoulder braid..... 1
- suicide strap (patent leather)..... 1
- tie (black)..... 1

Honor Guard members will return all supplemental issue items when they are no longer assigned to the Honor Guard.

**3-521.16 SUPPLEMENTAL ISSUE – SPECIAL EVENT RESPONSE TEAM (SERT)**

- Shirt, BDU (long sleeve)..... 3
- Trousers, BDU..... 3

**3-530 SPECIFIC UNIFORM RULES**

The following sections contain specific rules regarding the various uniforms or parts of the uniform.

**3-531 UNIFORM SHIRTS / NECKTIE / MOCK TURTLENECK DICKIE**

Uniform shirts shall be either white or dark brown, depending on rank. The style and make will be as prescribed and authorized by the Sheriff. The shirt shall have the Sheriff's shoulder patch on each shoulder. The shirt shall be worn with collar brass, a name tag, pistol badge, CALEA pin, American flag ribbon, and the issued badge. The collar brass will consist of rank insignia for Lieutenants and above, and the Agency collar brass for Sergeants and below.

Commissioned officers (Lieutenant and above):



Administrative and Operational Manual

September 12, 2022

- White long sleeve shirt with black tie (basic winter uniform)
- White short sleeve shirt without tie (basic summer uniform)

Non-commissioned officers (Sergeant and below):

- Brown long sleeve shirt with taupe tie (basic winter uniform)
- Brown short sleeve shirt without tie (basic summer uniform)

Sergeants and below may wear the mock turtleneck dickie in lieu of the tie except when appearing in Circuit Court. Officers appearing in Circuit Court will wear the uniform of the day.

**3-532 NON-COMMISSIONED OFFICERS DISPLAY OF RANK**

The display of rank for non-commissioned officers (Sergeant and below), both sworn and correctional, shall be by use of cloth chevrons. Cloth chevrons shall be displayed on outer garments.

All non-commissioned officers shall wear the issued collar brass on the shirt collar. There shall be one pin on each collar tip in accordance with the illustrations and instructions contained in Section 3-580 of this Manual.

Sergeants will wear three cloth chevrons on each sleeve of the winter and summer shirts and on each outer garment sleeve.

Master Sergeants will wear three cloth chevrons with two bottom chevrons and star in the middle on each sleeve of the winter and summer shirts and on each outer garment sleeve.

Corporals will wear two cloth chevrons on each sleeve of the winter and summer shirts and on each outer garment sleeve.

Master Corporals will wear two cloth chevrons with two bottom chevrons and star in the middle on each sleeve of the winter and summer shirts and on each outer garment sleeve.

PFCs / CFCs will wear one cloth chevron on each sleeve of the winter and summer shirts and on each outer garment sleeve.

**3-533 RANK DISPLAY PINS**

Officers, the rank of Lieutenant and above, shall wear collar and epaulet pins to designate rank. The pins shall be of two sizes, the smaller for use on the shirt collar and the larger for use on outer garment epaulets. The pin for each rank is as follows:

- Sheriff.....gold stars, silver eagle, gold bar with "Sheriff" inscribed
- Lieutenant Colonel ..... silver oak leaf
- Major.....gold oak leaf
- Captain .....two gold bars
- Director (Corrections) .....the word "Director"
- Deputy Director (Corrections) ..... the words "Deputy Director"
- Lieutenant..... one gold bar

The issued collar brass shall not be displayed on epaulets of outer garments as a rank insignia. It will, however, be displayed on the collar of certain outer garments for non-commissioned officers.



## Administrative and Operational Manual

September 12, 2022

### 3-534 BADGES

The authorized badge is issued by the Agency. Badges shall not be sold, transferred, or presented to anyone, except with the written approval of the Sheriff. A copy of written approval from the Sheriff will be provided to the Quartermaster.

Presentation badges will be awarded only in appropriately designed enclosures to prevent any unauthorized use or display.

Specialty badges, when authorized by the Sheriff (Agency Anniversary badges, Inaugural badges) may be purchased when they are commissioned. The Sheriff will designate the period of time that these badges may be worn by sworn officers. For example, Inauguration badges may be worn from January 1 through January 31, or an Agency Anniversary badge may be worn from January 1 through December 31 of the year of the Anniversary. A specialty badge is the personal property of the officer who bought the badge and shall not be turned in upon separation from the Agency.

The badges will designate the following ranks / positions:

- Sheriff
- Lieutenant Colonel
- Major
- Captain
- Director (Corrections only)
- Deputy Director (Corrections only)
- Lieutenant
- Master Sergeant
- Sergeant
- Master Corporal
- Corporal
- Detective
- Officer (for rank of Police Officer, Police Officer First Class, Correctional Officer, Correctional Officer First Class)

The Agency badge will have an inventory / security control system for accountability purposes. This system shall be as follows:

- Badges designated as "Officer" on the top front panel will have a control number on the reverse side beginning with 001.
- All other sworn positions beginning with the rank of Sergeant, to include Detective, will be sequentially numbered starting from "1," prefixed by an appropriate letter (example: Sergeant - S 1). Flat badges shall be prefixed by the letter "P."
- Officer badge number 001 shall be archived with the Agency as a historical artifact. It will be displayed within a sealed presentation case. This case will also contain a notarized document citing the significance of the badge design and the date of its official introduction (May 10, 1992), which is the three hundred thirty-fourth birthday of Charles County.
- Any badge that becomes unaccounted for shall be investigated by the officer's supervisor or their designee, who will ensure an Incident Report and a Loss / Damage Report Form #310 are completed and forwarded through the chain of command. The supervisor shall cause the badge description to be entered into MILES / NCIC and will complete a Crime Information Report prior to securing from duty. A copy of the Incident

**Administrative and Operational Manual****September 12, 2022**

Report and Form #310 will be provided to OPR and presented to the Quartermaster prior to badge replacement.

Upon change of rank or reassignment that necessitates a badge change, the officer shall surrender both his issued badges to the Quartermaster and shall be issued replacements for each based on the rank change or reassignment.

When a current sworn or corrections officer has successfully completed all formal entry-level training (including the Academy or Comparative Compliance and the Field Training Officer Program) and wishes to have a flat badge to carry off duty instead of using the issued domed badge, the officer may pay for the cost of the badge. The flat badge will have the initials and last name of the officer above the "SHERIFF'S POLICE" for police and below "CHARLES COUNTY" for corrections (i.e., A.A. SMITH). The back will have imprinted the letter "P" or "C" followed by the officer's ID number (i.e., P123 or C123). No deviation from the stated engraving is permissible.

When an officer separates employment, issued badges shall be turned in to the issuing authority. A purchased flat badge is the personal property of the officer who bought the badge and shall not be turned in.

Upon retirement from the Agency, sworn and correctional officers will be afforded the privilege of having the Agency badge designating their rank at the time of retirement (example: Sergeant - Ret). The reverse side of the badge will be engraved with the officer's full name, ID number, and dates of service. Dates of service refers to the time-span starting when the officer began wearing the respective badge (sworn or corrections) and ending at retirement. The dates of service will display the year only (e.g., 1970-1995).

Upon retirement from the Agency, sworn and correctional officers will also have the opportunity to purchase one of the domed badges issued to them, depicting their rank at the time of retirement. Sworn and correctional officers may only purchase one of their issued badges. To purchase the badge, the officer must submit their request in writing accompanied by a memorandum cover sheet Form #144 through the chain of command to their Division Commander. The Division Commander will forward the request to the Commander, Special Services Division. The Commander, Special Services Division will notify the employee regarding the disposition of their request. The Commander, Special Services Division will forward the original memorandum to the employee's personnel file maintained by Human Resources. The Commander, Special Services, or his designee shall submit the funds collected for the badge to the Deputy Director, Accounting. The Commander, Special Services or his designee, shall ensure that replacement badges are ordered as necessary to replenish the Agency inventory.

**3-534.1 COLLAR BRASS**

The Quartermaster stocks the authorized collar brass; employees wearing the 350<sup>th</sup> Anniversary collar brass may continue doing so until it needs to be replaced. At that time, it will be replaced with collar brass similar to the Anniversary collar brass, but without the "350 YEARS" notation.

The collar brass will be worn with the dress uniform (winter / summer) by all component personnel, with the exception of officers the rank of Lieutenant and above, K-9, and EST. Collar brass will also be worn with the basic winter and summer uniform shirt as depicted elsewhere in this chapter. Officers the rank of Lieutenant and above will wear rank insignia when collar brass is required. Collar brass will not be worn with the sworn officer BDU.

**3-535 DRESS BLOUSE**

The dress blouse shall be dark brown in color with taupe tan epaulets. The blouse will be of a style and material authorized and approved by the Sheriff. The dress blouse is worn over the long sleeve shirt with accouterments. The blouse has a single taupe tan or gold braids on the lower sleeve, depending on the rank of the officer. The Sheriff will have five (5) gold braids; the Lieutenant Colonel will have four (4) gold braids; Majors will have three (3) gold braids; Captains / directors / deputy directors will have two (2) gold braids; Lieutenants will have one (1) gold braid; and all others will have one taupe braid. Some commissioned officers' blouses issued prior to April 1, 1997 may have several gold braids dependent on the rank of the person to whom it was issued. Blouses so issued may be worn until they are no longer serviceable or are replaced due to the promotion or retirement of the person to whom they were issued. The blouse has the Sheriff's shoulder patch on each shoulder.

**Administrative and Operational Manual****September 12, 2022**

The issued dress blouse is an optional uniform which may be worn at any time. The blouse will be issued to all sworn officers and to all Corrections officers the rank of Lieutenant and above. The blouse is also issued to members of the Honor Guard. The senior officer attending any ceremony, banquet, funeral, or other event will coordinate the type of uniform if one is to be worn to ensure against various uniforms being displayed.

Generally, anytime an employee attends a function which he would attend in business attire and elects to wear the Agency uniform, the issued dress blouse shall be worn unless otherwise directed by appropriate authority. Refer to applicable AOM section for court attire.

**3-536 UNIFORM TROUSERS**

Trousers shall be taupe tan in color and of a style and material authorized and approved by the Sheriff. Uniform trousers are worn with the dress, winter, and summer uniforms.

**3-538 GORE-TEX PATROL JACKET**

The uniform Gore-tex® patrol jacket will be the standard winter coat for corrections officers and sworn officers of the rank of Sergeant and below. Certain command officers, because of assignment, may be authorized by their division commander to wear the Gore-tex® patrol jacket.

**3-539 WOOL PATROL JACKET**

An alternate winter coat, for sworn personnel of the rank of Sergeant and below, may be the wool patrol jacket if issued prior to February 1, 1999. The wool patrol jacket shall be the standard winter coat for sworn personnel of the rank of Lieutenant and above.

**3-540 WEARING OF THE PATROL JACKET**

The Gore-tex® or wool patrol jacket may be worn, by those employees authorized to wear it, over the summer, winter, or utility / BDU uniform. This jacket may be worn at any time weather conditions warrant its wearing. Employees wearing the patrol jacket shall display the following:

- Breast badge;
- Nameplate;
- Shoulder patches;
- Rank insignia (Lieutenants and above shall wear the large metal rank insignia on the epaulets, and Sergeants and below shall wear cloth chevrons);
- Commissioned officers shall wear a gold braid on each sleeve of the wool patrol jacket. Non-commissioned officers shall wear a taupe tan braid on each sleeve; and
- Collar brass displayed on the uniform blouse shall be worn on the wool patrol jacket.

**3-541 WOOL PULLOVER SWEATER (COMMANDO SWEATER)**

The wool pullover long sleeve V-neck sweater, brown in color, commonly referred to as the commando sweater, may be worn as an outer garment over the winter uniform or underneath the patrol jacket.

When wearing the commando sweater as an outer garment, the following uniform accouterments shall be displayed in the appropriate location, as required:



**Administrative and Operational Manual**

**September 12, 2022**

- Shoulder patch on both sleeves;
- Breast badge;
- Nameplate; and
- Rank insignia (Lieutenants and above shall wear the large metal rank insignia on the epaulets, and Sergeants and below shall wear cloth chevrons).

A tie will be worn with the V-neck commando sweater. It shall be tucked inside the uniform trousers and not interfere with the officer's equipment which is secured around the waist area.

**3-542 REEFER OVERCOAT**

This item is obsolete and is no longer issued. It may be worn by those employees to whom it was issued until it is no longer serviceable. This coat may be worn with the winter uniforms with the nameplate and breast badge displayed. Shoulder patches will be worn on both sleeves and only commissioned officers are authorized to wear rank insignia (large metal on epaulets).

**3-543 RAID JACKET**

This article of clothing shall be of a brand and style adopted by the division commander and authorized by the Sheriff. Its procurement will be through the division commander at employee expense.

This jacket may only be worn in accordance with the employee's formal division SOP. If an SOP concerning raid jackets has not been approved for the employee's division by the employee's division commander and the Sheriff, the raid jacket shall not be worn.

**3-544 SHOULDER PATCHES**

Shoulder patches shall be of a design approved by the Sheriff. The Quartermaster shall acquire and stock such shoulder patches in the approved design and in such quantities as may be needed to meet the Agency's needs.

**3-545 RAIN GEAR**

During periods of precipitation, officers may wear the issued authorized rain gear, with the lighter color displayed. Only the breast badge is displayed. Commissioned officers are authorized to wear the black military style all-weather coat with large metal rank insignia on the epaulets. Hat protectors, smoke / clear vinyl, may be worn over the Stetson hat during periods of precipitation.

**3-546 UNDERSHIRTS**

Undershirts, white in color, may be worn with any uniform, except the BDU, in which case a black undershirt, if visible, will be worn. No lettering or designs may be visible.

**3-547 FOOTWEAR**

Footwear utilized by uniformed Agency personnel will conform to the following conditions:

- Shoes shall be leather or other high gloss material, black in color and of plain design with no visible labels or lettering. The toe of the shoe shall be plain with no stitching.



## Administrative and Operational Manual

September 12, 2022

- Shoes and boots shall be kept clean and shined.
- Shoes may be low quarter or ankle high with lace or inside zipper closure.
- Athletic style shoes that are black, lace-up, with black sole edges, are authorized for wear with the basic winter and summer uniforms during normal work assignments. When worn, they must be shined.
- Sole edges and stitching shall be blackened.
- Military style boots are authorized if all parts are black in color.
- Military style boots may be of lace or zipper closure. The toes and heels will be hi-gloss or capable of retaining a shine.
- Military style boots are authorized for wear with any uniform except the dress uniform.
- Sole taps are authorized for wear by the Honor Guard only.
- Lace closures may not extend toward the toe closer than on original issue shoes.

Footwear, except for the riding boots of motorcycle officers, are not a Quartermaster replaceable item, even though they may have been original issue items.

### 3-548 RAIN BOOTS

Rain boots or low quarter storm rubbers, black in color, are authorized. They may only be worn during periods of precipitation, standing water, or snow.

### 3-549 HEADGEAR

Headgear shall be worn as follows:

**Winter felt hat** – (Stetson style) worn with the dress uniform and may be worn with the winter uniform. A black leather hatband will be worn around the crown sitting on the brim. The buckle shall be silver and the extra portion of the hat strap shall extend towards the wearer's left, past the buckle. A two-piece black leather strap with silver buckle shall extend through the provided holes in each side of the brim and be attached to the leather strap circling the crown. This strap shall extend around the rear portion of the wearer's head.

**Straw hat** - may be worn with the summer uniform. The hat straps shall be the same as prescribed for the winter felt (Stetson style) hat.

**Fur style hat** – approved, but is no longer issued; may be worn during inclement weather when authorized as part of the winter uniform. A County Seal shall be worn centered on the front flap.

**Agency ball cap** - black in color with a reduced replica of the Agency's shoulder patch worn centered on the front of the hat crown. The size and appearance of the reduced replica Agency shoulder patch will be prescribed by the Sheriff. The ball cap may be worn instead of the winter felt or summer straw hat, when the utility uniform / BDU is worn. The Agency issued ball cap shall be worn with the visor portion facing directly forward. Wearing the hat with the visor off to one side or to the back is prohibited.

**Black knit hat** - worn only with the BDU.

When any hat is worn, it will be worn straight and level on the head. No hair will protrude from the front of the hat onto the forehead.





Administrative and Operational Manual

September 12, 2022

### 3-550 NECKTIE

The authorized uniform tie is the breakaway type, black or taupe in color, depending on rank. The tie is worn with a tie tack, the knot centered over the closed neck button. It shall not be worn in any other fashion.

### 3-551 SOCKS

All uniformed employees shall wear socks. Exposed portions of socks shall be black in color and non-transparent.

### 3-552 GLOVES

Gloves for uniformed employees shall be plain black whose material covers the entire hand to wrist. Gloves may be worn only during cold or inclement weather, except that division commanders may authorize other styles for a specific purpose. Gloves containing lead, sand, or other weighted material are prohibited. White military style gloves are authorized for special events, when approved by the officer in charge.

### 3-553 MOURNING BANDS AND RIBBONS

Uniformed personnel shall wear mourning bands on the issued Agency badge. All other employees shall wear the mourning ribbon on an outer garment in a location of the employee's discretion. These devices are available on an as-needed basis from the Quartermaster. Unless an official mourning period is established by the Sheriff, personnel are authorized to wear the mourning band / ribbon as follows:

- For the death of a CCSO officer who has been killed in the line of duty or who has died from injuries and/or wounds sustained in the line of duty, from the time of death until midnight on the 30<sup>th</sup> day after the death;
- For the death of an officer within our region (Charles, Prince George's, St. Mary's, Calvert, Anne Arundel counties, any Maryland State Law Enforcement agency, any Law Enforcement agency in Washington, D.C.), from the time of death until midnight on the day of the funeral;
- For the death of out-of-region officers, while attending the funeral or other memorial service;
- On National Peace Officers Memorial Day (May 15), from 0001 hours until 2359 hours;
- Any other time, as determined by the Sheriff or his designee.

#### 3-553.1 U. S. FLAG RIBBON

The issued U. S. Flag ribbon shall be worn on the outer uniform garment centered above all other authorized accouterments at the right breast pocket. No other flag pins / ribbons are authorized.

#### 3-553.2 CALEA ACCREDITATION PIN

The CALEA Accreditation Pin will be worn by sworn and corrections officers on the blouse and uniform shirt. The pin will be centered on the left breast pocket flap midway between the button and the bottom of the pistol marksmanship badge. All other uniformed Agency personnel are authorized to wear the pin centered on the left



**Administrative and Operational Manual**

**September 12, 2022**

---

breast pocket flap of the uniform shirt or blouse. Display by civilian employees is at the employee's discretion, on the upper garment or Agency ID lanyard. Civilian employees will be issued one pin by the quartermaster. Additional pins may be purchased by any employee at the current replacement cost.



Administrative and Operational Manual

September 12, 2022

### **3-554 GROOMING STANDARDS**

#### **3-554.1 ALL AGENCY EMPLOYEES**

##### **3-554.1.1 TATTOOS**

It is not the Agency's intention to infringe upon any employee's personal freedoms; however, it is within the Sheriff's prerogative to govern the actions and appearance of his employees insofar as they impact the efficient operations of the Agency. A significant part of the Agency's mission is accomplished by instilling confidence in the general public, and in doing so, employees should strive to avoid shocking or otherwise making citizens uncomfortable in their presence.

In general, displaying tattoos / body art depicting the following is prohibited at any time if visible to the general public during the normal performance of the employee's duties:

- racism;
- sexism;
- obscenity; or
- profanity.

The Sheriff or his designee shall render final judgment in these matters.

##### **3-554.1.2 UNCONVENTIONAL BODY PIERCING**

All Agency employees while on duty, representing the Agency or displaying any official Agency logo, are prohibited from displaying unconventional body piercing jewelry including, but not limited to, on or in:

- the tongue;
- the nose;
- the cheek;
- the eyebrow; and
- the lip.

Prohibitions also include, but are not limited to: foreign objects inserted under the skin; pierced, split or forked tongues; and/or stretched-out holes in the ears, gauges, and hole plugs.

Any exceptions to these provisions shall be approved in advance by the Sheriff or his designee.

##### **3-554.1.3 DENTAL ORNAMENTATION**

Visible dental ornamentation, such as filings, gold / silver fillings or appliques are prohibited unless deemed medically necessary.

#### **3-554.2 UNIFORMED SWORN POLICE AND CORRECTIONS MEMBERS**

##### **3-554.2.1 HAIR REGULATIONS**

Uniformed sworn police and corrections members shall adhere to the following hair regulations:

- Hair shall be neat, clean, properly trimmed, and well-groomed while members are on-duty. The coloring, style, or cut shall not detract from or degrade the intent of the uniform or position.



Administrative and Operational Manual

September 12, 2022

- Only natural hair colors are permitted (i.e. no pink, blue, green, etc.).
- Hairstyles shall be professional in appearance. Extreme or fad hairstyles are prohibited, including but not limited to those that incorporate designs or sculptures using the hair and/or cut into the hair, and any style that presents an unprofessional or disheveled appearance.
- The bulk or length of the hair should not interfere with the normal wearing of the uniform hat and no hair shall show under the front brim of the uniform hat.
- For male uniformed members, the hair on the top of the head shall be neatly trimmed and the sides shall not fall over the ear. The sides and back of the hair shall be neatly trimmed and tapered. The hair on the sides and back of the head shall not protrude from the bottom edge of the uniform hat in such a manner that the hair appears to bulge outward.
- Female uniformed members' hair may touch the shirt collar, but shall not fall below the collar's lowest edge to the rear.
- Any hairstyle that is bound, such as braids, and meets the above requirements must be worn close to the head and present a professional appearance.
- Hairpieces or wigs, if worn on duty, shall present a natural appearance, shall not interfere with the proper performance of duty, and shall not present a safety hazard. If worn while in uniform, the hairpiece or wig shall comply with the provisions of this section.
- Objects worn in the hair shall be for the sole purpose of holding the hair in place and shall be similar in color to the individual's hair color or be solid navy blue or black. No object should interfere with the wearing of the uniform hat. Any item that can be used as a weapon against the officer is prohibited.

3-554.2.2 FACIAL HAIR

DEFINITIONS

- **Shaving** – Shaving is defined in this policy to mean the cutting of facial hair with a blade or other device which is designed to cut the facial hair even with the skin.
- **Trimming** – Trimming is defined in this policy to mean the cutting of facial hair with a trimming device which is designed to cut facial hair closely to the skin, but not even with the skin.

Uniformed sworn police and corrections members shall adhere to the following facial hair regulations:

- Sideburns shall be neatly trimmed. They shall not extend below mid-ear; they shall be of even width (not flared) and end with a clean-shaven horizontal line.
- A neatly trimmed mustache is permissible. Mustache hair shall not extend more than 1/4" below or beyond the line of the employee's upper lip.
- Facial hair is generally not permitted. Employees should shave regularly to ensure they are adhering to this policy. However, exceptions may be made for good cause, as detailed below.

SHAVING WAIVERS

An employee being treated for a facial skin disorder or other medical condition which is aggravated by shaving may request an exception by submitting a Shaving Waiver Form #353 completed by their physician or dermatologist. Under normal circumstances, the Form #353 will be sufficient documentation for a waiver. If the



Administrative and Operational Manual

September 12, 2022

physician / dermatologist does not believe the employee can comply with the standards stated on the form, the request will likely be denied. The request will be submitted to the Sheriff through the chain of command. Employees should receive a reply within five business days of receipt by their immediate supervisor. In cases where the requesting employee does not receive a reply within five days, the employee may consider the request approved until hearing otherwise. If a waiver is granted, the employee must maintain a close and neatly trimmed appearance with maximum facial hair length of approximately 1/8 inch. Goatees and other styling of the facial hair are not permitted. Authorization shall be for a six-month period; updated requests are required for any extended periods in increments of six months, using the Form #353.

Supervisors will not attempt to actually measure an employee's facial hair, but will use their best judgment and discretion to ensure the employee maintains a professional appearance. Accepting that the supervisor is acting on good faith, employees will comply with a supervisor's order to alter their facial hair to meet policy.

Human Resources will maintain a current list of employees who have been granted a shaving waiver due to their condition. Supervisors / commanders may contact HR to verify if a particular employee is on the list. HR will also provide division commanders with information about employees who have a valid shaving waiver on file. The affected officer shall maintain, and make available, a copy of his most current shaving waiver to supervisory / command authority.

Employees who are unable to conform to the Agency's grooming standards shall be placed on leave until they are able to comply or they receive a valid waiver. Employees who do not qualify for a waiver and refuse to comply with the Agency's grooming standards may be subject to disciplinary action.

The following photos are provided as examples to be used by supervisors and employees of acceptable facial hair length for those who have been granted a shaving waiver. Hair length of approximately 1/8 inch and of an even length all over is permitted.



The following photos are provided as examples to be used by supervisors and employees of unacceptable facial hair length and style for those permitted facial hair due to a shaving waiver. Hair length of more than approximately 1/8 inch and of a shaped and stylized form is not permitted.



**3-554.2.3 MAKEUP AND JEWELRY**

Uniformed sworn police and corrections members shall adhere to the following makeup and jewelry regulations:



## Administrative and Operational Manual

September 12, 2022

- Makeup may be worn if it is natural in color and does not detract from or degrade the intent of the uniform or position.
- Necklaces, medals, etc., may be worn if they are not visible. Visible medical bracelets are permitted.
- Female uniformed members may wear fingernail polish, provided the polish is clear, there are no adornments, and nails are kept at a length that does not interfere with the performance of the employee's duties.
- Female uniformed members are permitted to wear one stud-type earring per ear while on duty.
- Male uniformed members shall not wear earrings or other visible piercings while on duty, outside of covert operations.
- Loop, wrap, or dangle style earrings are prohibited.

Any exceptions to these provisions shall be approved in advance by the Sheriff or his designee.

### 3-554.2.4 EYE WEAR

The following are prohibited when wearing eyeglasses or sunglasses in uniform:

- Straps, except plain black straps, which maintain the glasses and should be a breakaway style;
- Eccentric or faddish styles or frames;
- Mirrored lenses; and
- Unnaturally colored contact lenses.

### 3-554.3 CIVILIAN MEMBERS GROOMING STANDARDS

To achieve and maintain the highest standard of professional excellence is a primary objective of the Agency. One of the qualities that marks a professional organization is the exemplary appearance of all of its personnel. The Agency is often judged by the appearance of a single employee; the dress and grooming of all civilian members must establish and maintain the credibility and professional standards of the Agency.

The Sheriff reserves the right to determine appropriate attire for civilian employees. In the event an employee is uncertain about policy compliance, other attire should be worn until specific permission is obtained.

All members must dress in a neat, clean, and professional manner, including on casual days.

Hair or hairpieces shall be neat, clean, and groomed in such a fashion as not to interfere with the employee's duties.

Beards, goatees and mustaches shall be neat, trimmed, and shall not interfere with the performance of the employee's duties.

Fingernails may be polished provided there are no adornments and nails are kept at a length that does not interfere with the employee's duties.

Makeup may be worn if it is natural in color and does not detract from or degrade the intent of the position.

Jewelry that detracts from a professional appearance or that could be offensive or disturbing to others shall not be worn. Jewelry shall not interfere with the performance of the employee's duties.

### 3-555 NAMEPLATE

The authorized nameplate is rectangular, gold colored, with the wearer's first initial, middle initial and last name centered in black capitalized Roman letters. A nameplate is displayed on the following outer garments:

**Administrative and Operational Manual****September 12, 2022**

- Blouse;
- Uniform shirt worn as the outer garment;
- Jacket;
- Reefer; and
- Commando sweater worn as the outer garment.

**3-556 COAT COLLAR BRASS**

The authorized collar brass is issued by the Quartermaster and shall be worn by officers below the rank of Lieutenant. Collar rank insignia is to be worn only by Lieutenants, Captains, Majors, Lieutenant Colonels, and the Sheriff. These items shall be displayed on the dress blouse and the wool patrol jacket.

**3-557 TIE DEVICES**

The authorized issued tie tack shall be metal with the Agency's currently approved design. When worn, it shall be centered on the tie at a point centered on the horizontal line formed by extension of the tips of the shirt pocket flaps.

**3-558 SPECIAL INSIGNIA PINS**

Special insignia pins shall be worn only by officers currently assigned the duties denoted by the insignia or belonging to the denoted organization. Officers may wear a maximum of two insignia pins on any uniform outer garment (except rainwear) or uniform shirt. When two insignia pins are worn, they shall be side by side, centered on the right breast pocket flap, midway between the button and the top of the pocket flap. The following are authorized insignia pins:

- K-9;
- Field Training Officer;
- Emergency Services Team (EST, 2 issued);
- Traffic Operations Officer;
- Traffic Safety Specialist Award;
- Motorcycle Officer;
- Crime Prevention;
- Drug Abuse Resistance Education;
- Emergency Medical Technician;
- Honor Guard;
- Emergency Response Team (ERT);
- Special Events Response Team (SERT);
- Fraternal Order of Police;
- F.B.I.N.A.;
- Hostage Negotiating Team (HNT);
- Emergency Communications Specialist (ECS);
- Maryland Sheriffs' Association Insignia;
- Maryland Chiefs' Association Insignia;
- Community Policing (Agency Supplied);
- L.E.E.D.S.;
- Peer Mentor (Corrections); and
- Northwestern University Center for Public Safety School of Police Staff and Command.



## Administrative and Operational Manual

September 12, 2022

### 3-559 AWARD ACCOUTERMENTS

Award medals and ribbons are an optional accouterment to the uniform. The wearing and display of awards on the uniform does not reflect any specific military organization and only reflects the needs of the Sheriff's Office.

Valor Award medals may be worn only on the dress blouse uniform. The medals will be centered on the wearer's right pocket with the top of the ribbon just under the pocket flap in a descending precedence from the center of the chest outwards. Only one medal of each class may be worn at any time. Subsequent medals of the same type will be denoted by a star (gold, silver or bronze) centered on the ribbon material holding the medal. When Valor Award medals are worn, special insignia pins are not to be worn.

Award and service ribbons may be worn either on the dress blouse or the basic winter / summer uniform. Ribbons will be arranged by a descending precedence from the center of the chest outwards and worn centered 1/8" above the name plate. If an officer has three or more ribbons, the first two ribbons will be in a single row and additional ribbons will be centered above the first group. Only two ribbons will be worn in a single row and the highest awards will be centered above the lower preceding awards. The order of precedence is:

- Gold medal of valor;
- Silver medal of valor;
- Bronze medal of valor;
- Agency injury citation;
- Merit award;
- Sheriff's award;
- Lifesaving award; and
- Years of service award.

Only one ribbon of each type may be displayed; subsequent awards of the same type will be denoted by an additional star placed upon the original ribbon for each additional award. When a sixth award of any ribbon type is earned, the stars are replaced with an oak leaf cluster.

**NOTE:** Valor and other types of awards from other law enforcement agencies, which are approved for wear, will be placed according to the dictates of the approval document as explained elsewhere in this Manual.

### 3-562 MARKSMANSHIP BADGE

Marksmanship badges shall be of a style and design authorized by the Sheriff. The marksmanship badge shall be worn on the blouse and uniform shirts, centered at the top of the left breast pocket.

### 3-563 SAM BROWNE BELT / POLICE EQUIPMENT BELT

The authorized issued police equipment belt shall be of plain black leather design with a maximum width of 2 1/4" (basket weave or webbed styles prohibited); patent leather and double stitching are authorized. The belt shall have solid brass or brass colored metal buckle, which is capable of being polished.

### 3-564 GARRISON BELT

The authorized issued Garrison belt is plain black with a gold buckle with a maximum width of 1 3/4." Also authorized is a plain black belt with Velcro closure and no buckle, with a maximum width of 1 3/4". Authorized buckles are:

- Single pin brass (original issue); and
- CCSO plate belt buckle.





Administrative and Operational Manual

September 12, 2022

When the Garrison belt is visible, it will be worn with an authorized buckle.

### **3-565 REQUIRED ARTICLES ON POLICE EQUIPMENT BELTS (SWORN)**

The following are required articles on police equipment (Sam Browne) belts for sworn officers:

- Authorized service handgun in the authorized holster;
- Authorized handcuff case and handcuffs;
- Authorized OC Spray holder and OC Spray;
- Collapsible baton in holder;
- Authorized magazine holder with fully loaded magazine(s);
- Portable radio carrier (Agency issued case or clip); and
- Belt keepers.

### **3-566 REQUIRED ARTICLES ON POLICE EQUIPMENT BELTS (CORRECTIONS)**

The following are required articles on police equipment (Sam Browne) belts for Corrections officers:

- Authorized OC holder and OC spray;
- Emergency responder kit;
- Handcuff case and handcuffs; and
- Portable radio holder.

### **3-567 OPTIONAL ARTICLES ON POLICE EQUIPMENT BELTS (SWORN)**

The following are permitted articles on police equipment (Sam Browne) belts worn by sworn officers:

- Key ring holder;
- Miniature flashlight holder;
- Flashlight holder; and/or
- Cell phone (Agency issued only).

The issued magazine / handcuff pouch may be worn with civilian attire or on the Garrison belt when in uniform.

### **3-568 OPTIONAL ARTICLES ON POLICE EQUIPMENT BELTS (CORRECTIONS)**

The following are permitted articles on police equipment (Sam Browne) belts worn by Corrections officers:

- Double handcuff holder with two sets of handcuffs;
- Key ring holder;
- Keepers, belt;
- Miniature flashlight holder and flashlight;
- Cell phone (Agency issued only).

### **3-569 BELT KEEPERS**

Belt keepers shall be plain black, a maximum of 1" in width, with inside hidden snaps. A minimum of one shall be worn in the back of the belt and a maximum of four total shall be worn.



**Administrative and Operational Manual**

**September 12, 2022**

---

**3-570 MAGAZINE HOLDER**

The authorized issued magazine holder is plain black or hi-gloss, single or double, Velcro or brass snap fastener, and worn vertical on the Sam Browne belt.

**3-571 HANDCUFF CASE**

The authorized issued handcuff case is plain black or hi-gloss, single or double, with brass snap or inside fastener.

**3-572 BATON AND BATON HOLDER**

Only the issued collapsible baton shall be possessed or used by all officers. The holder shall be black in color.

**3-573 MINIATURE FLASHLIGHT**

Small flashlights of any material are permitted. The flashlight shall be black in color with a maximum length of 7 2."

**3-574 HOLSTERS**

The authorized holsters will be plain black or hi-gloss and worn on the Sam Browne or Garrison belt, on the wearer's strong hand side. The holsters will be of a style and model authorized by the Sheriff.

**3-575 PORTABLE RADIO CARRIERS**

The portable radio carrier shall be plain black in color and of a type authorized by the Sheriff.

**3-576 ITEMS ARRANGED ON POLICE EQUIPMENT BELT**

Items listed below are to be worn on the belt. The handgun holster is worn on the strong hand side and the radio carrier is worn on the side opposite the holster. The magazine holder is in front as the closest item to the buckle.

- Magazine holder;
- OC Spray holder;
- Portable radio carrier;
- Collapsible baton and holder;
- Mini-flashlight holder (optional);
- Handcuffs and case;
- Key ring holder (optional);
- Mag-light® holder (optional - worn directly behind the holster); and
- Cell phone (optional, Agency issued only).

**3-577 ISSUED BODY ARMOR**



## Administrative and Operational Manual

September 12, 2022

- 6-point adjustable carrier;
- Ballistic panels (interchangeable for use in either carrier);
- 5" x 8" sternum plate.

### 3-577.1 GENERAL GUIDELINES

All sworn officers are issued body armor and are strongly encouraged to wear it at all times while performing their duties. Wearing of the body armor is mandatory for all uniformed officers engaged in patrol, enforcement operations, security assignments and while working at the Charles County Courthouse.

A supervisor can order the wearing of body armor under any circumstances he determines appropriate, such as potentially high-risk situations. Consequently, this equipment shall be immediately available for INSTANT USE to all personnel within this Agency, who have received an initial issue. Under exigent circumstances, body armor can be worn, either on- or off-duty, over the uniform or civilian attire, in order to provide for some measure of protection. Body armor shall become an item of inspection during the monthly vehicle inspections.

### 3-577.2 EXTERNAL BODY ARMOR CARRIER

The panels of the Agency issued body armor may be worn in an external body armor carrier, under the following conditions:

- the external carrier must be in the Agency's uniform shirt brown color;
- the carrier must be purchased at the employee's expense;
- the employee must have supplied the serial number of the employee's Agency issued vest when ordering the carrier, to make sure the carrier will fit the protective panels already issued;
- the carrier may be worn during all shifts; however, officers shall not wear the carrier if they are scheduled to appear in Court;
- officers wearing the carrier on day work must wear the same items on the carrier that are worn on the issued and approved uniform shirt;
- officers wearing the carrier for night work are permitted to display either the name tape and cloth badge or the brass badge and name plate; however, the Agency brass and/or nameplate cannot be worn over the name tape and cloth badge on the carrier;
- the carrier is not a tactical vest and is not to be used as one; the only items to be carried in the pockets of this carrier are those items which would normally be carried in the pockets of the issued uniform shirt. Examples of items NOT to be carried in the pockets of the body armor carrier include:
  - radios
  - flashlights
  - chemical sprays
  - oversized notebooks
  - the employee will maintain the carrier in a clean and presentable condition at the employee's expense.

A carrier which becomes unserviceable because of wear or damage will be disposed of through the Quartermaster. Replacement of these items will be at the expense of the employee.



## Administrative and Operational Manual

September 12, 2022

**3-577.3 TACTICAL VEST CARRIER**

The tactical vest carrier is authorized for wear under certain circumstances and is purchased at the employee's expense. All authorized users will wear the same style and color vest, which will have "Sheriff" on both the front and back. The Agency badge will be cloth or metal and worn on the front of the carrier. The tactical vest carrier will be worn only during police operations and is not authorized for court, meetings, other similar events, or generally while out in public. Approval for issue will be by the authority of either Assistant Sheriff.

**3-578 ISSUED TRAFFIC SAFETY VEST**

The use of high-visibility safety clothing on Federal-Aid Highways is mandated by federal regulation (23 CFR 634). Federal-Aid highways are those highways on the Federal-Aid highway systems and all other public roads not classified as local roads or rural minor collector roads.

All workers within the right-of-way of a Federal-Aid highway who are exposed either to traffic (vehicles using the highway for purposes of travel) or to construction equipment within the work area shall wear high-visibility safety clothing.

To help safeguard Agency employees, all sworn officers and other appropriate personnel have been issued highly visible, reflective safety vests that meet the performance Class 2 requirements of the American National Standard for High Visibility Safety Apparel (ANSI/ISEA). This vest is to be readily accessible at all times, whether on- or off-duty.

Officers are not required to wear high-visibility vests during routine traffic stops or when circumstances requiring immediate attention occur and do not allow time for retrieving and wearing the vest. At all other times, Agency employees shall wear the high-visibility vests while:

- directing traffic;
- investigating collisions;
- handling obstructed roadways or lane closures; and
- handling disasters within the right-of-way of a highway.

In addition to the instances listed above, the vest is to be worn as directed elsewhere in this Manual and:

- during searches for lost or missing persons;
- any other time immediate recognition is important and displaying the vest will not compromise a necessary tactical advantage; and
- at any time when directed by supervisory authority.

**3-580 ILLUSTRATION - BASIC WINTER UNIFORM SHIRT AND ACCOUTERMENTS**

**NAME PLATE:** Worn with bottom edge against top of shirt pocket flap, and centered above the flap.

**COLLAR ORNAMENT:** Sergeant and below shall wear the CCSO collar ornament, Lieutenant and above shall wear the appropriate rank insignia.



Administrative and Operational Manual

September 12, 2022

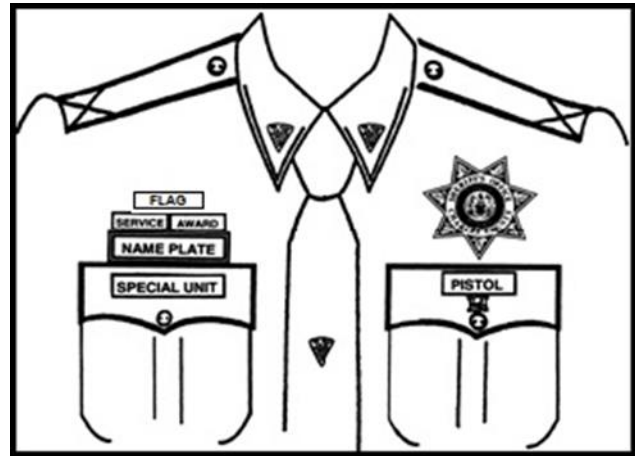

**Sergeant and below:**

**Long and Short sleeve** - worn on both collars with bottom point of the triangle pointing toward the point of the collar. The lower point of the collar ornament will be approximately 1" from the point of the collar.

**Lieutenant and above:**

**Long and Short Sleeve** - worn on both collars centered between the top and bottom of the collar. There will be approximately 1" between the tie edge of the collar and the rank insignia.

**3-581 ILLUSTRATION - COMMISSIONED OFFICERS WOOL PATROL JACKET AND BLOUSE**

Rank devices for Command Officers are worn centered on the epaulet, with the edge of the device one inch from the end of the epaulet.

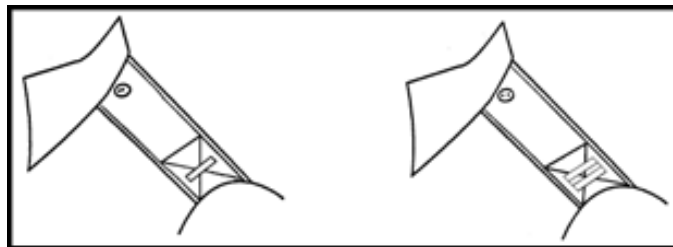

**3-583 ILLUSTRATION - DRESS BLOUSE / WOOL PATROL JACKET with COLLAR BRASS - LARGE STATE SEAL - COMMAND OFFICERS**

**COLLAR BRASS:** Large State Seal -- Worn centered vertically and horizontally in area just above lapel seam.

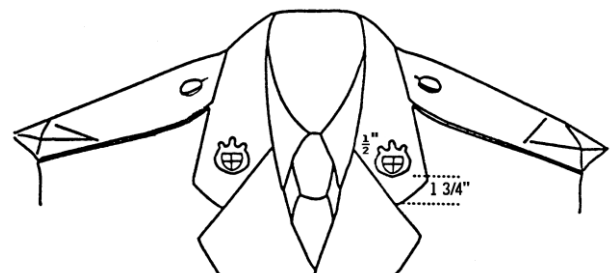



Administrative and Operational Manual

September 12, 2022

---

**3-584 ILLUSTRATION - DRESS BLOUSE/WOOL PATROL JACKET WITH COLLAR BRASS -NON-COMMAND OFFICERS**

**COLLAR BRASS:** - Worn centered vertically and horizontally in area just above lapel seam.

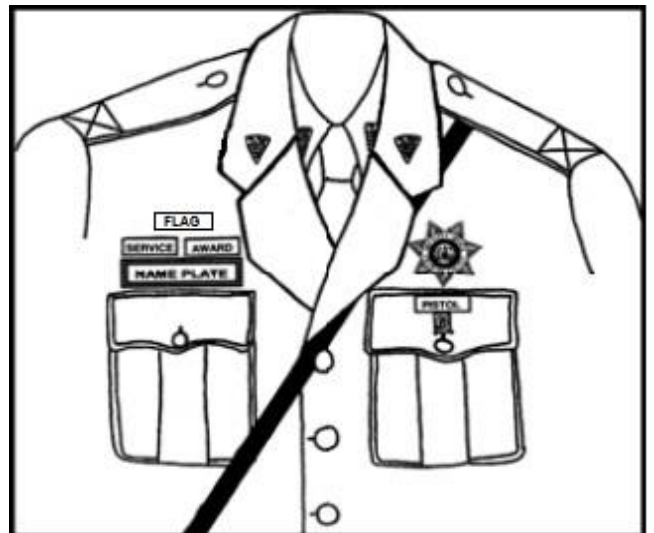



Administrative and Operational Manual

September 12, 2022

### 3-590 BASIC UNIFORMS DESCRIBED

The following sections describe the basic general uniforms of the Agency and how they are to be worn.

#### 3-590.1 DRESS UNIFORM - SWORN NON-COMMISSIONED OFFICERS

The Dress Uniform consists of:

- long sleeve brown shirt, with:
  - collar brass,
  - tie, and
  - tie tack,
- blouse with:
  - shoulder patches,
  - single taupe tan braid on each sleeve,
  - cloth chevrons (if issued with chevrons prior to 3/1/98 - rank boards if issued after 3/1/98),
  - marksmanship badge,
  - breast badge in holder,
  - collar brass,
  - nameplate,
  - special unit insignia,
  - U. S. Flag ribbon,
  - CALEA pins; and
  - award ribbons or medals;
- trousers,
- uniform shoes,
- socks,
- authorized Sam Browne belt (sworn only) with:
  - brass buckle,
  - authorized firearm and holster,
  - magazine holder and magazine(s),
  - authorized handcuff case with handcuffs,
  - cross strap, and
- felt Stetson hat.

#### 3-590.2 DRESS UNIFORM - SWORN AND CORRECTIONS COMMISSIONED OFFICERS

The Dress Uniform consists of:

- long sleeve white shirt with:



Administrative and Operational Manual

September 12, 2022

- collar brass (rank insignia),
- tie, and
- tie tack;
- blouse with:
  - shoulder patches,
  - single gold braid on each sleeve (or number corresponding to rank if issued with that braid prior to 4/1/97) ;
  - rank display device,
  - marksmanship medal,
  - breast badge in holder,
  - collar brass (Large State Seal),
  - nameplate,
  - special unit insignia,
  - award ribbons or medals,
  - U. S. Flag ribbon,
  - CALEA pins.
- trousers,
- uniform shoes,
- socks,
- Garrison belt with:
  - authorized buckle, and
  - authorized firearm and holster (sworn); and
- felt Stetson hat.

### 3-590.3 BASIC SWORN WINTER UNIFORM

This uniform consists of:

- long sleeve shirt with:
  - badge,
  - collar brass,
  - nameplate,
  - tie and tie tack,
  - special unit insignia (if assigned to a unit authorized to wear a unit insignia),
  - marksmanship badge,
  - U. S. Flag ribbon,
  - CALEA pin, and
  - Award ribbon(s) (if such award(s) have been earned);
- Garrison belt with authorized weapon and holster (if commissioned officer or optionally non-commissioned officer within Sheriff's Office facility),
- Sam Browne belt (non-commissioned officers), without cross strap, but with:
  - authorized firearm and holster,
  - handcuffs and handcuff case,





**Administrative and Operational Manual**

**September 12, 2022**

---

- OC spray and OC spray holder,
- collapsible baton and holder,
- fully loaded ammunition magazines and holder,
- portable radio carrier (issued case or clip),
- belt keepers,
- key ring holder (optional),
  
- miniature flashlight and holder (optional), and
- flashlight holder,
- trousers,
- uniform shoes or other authorized footwear, and
- felt Stetson hat.

### **3-590.4 BASIC SWORN SUMMER UNIFORM**

This uniform is the same as the Basic Winter Uniform with the exception that the uniform shirt is short sleeve and is normally worn without a tie or tie tack, and the straw Stetson hat is worn in place of the felt Stetson hat.

### **3-590.5 BASIC CORRECTIONS WINTER UNIFORM**

This uniform consists of:

- long sleeve shirt with:
  - badge,
  - collar brass,
  - nameplate,
  - tie and tie tack,
  - special unit insignia (if assigned to a unit authorized to wear a unit insignia),
  - marksmanship badge,
  - U. S. Flag ribbon,
  - CALEA pins, and
  - award ribbon(s) (if such award(s) have been earned),
  
- Garrison belt,
- trousers,
- uniform shoes or other authorized footwear, and
- socks.

### **3-590.6 BASIC CORRECTIONS SUMMER UNIFORM**

This uniform is the same as the Basic Winter Uniform with the exception that the uniform shirt is short sleeve and is normally worn without a tie or tie tack.



## Administrative and Operational Manual

September 12, 2022

### 3-590.7 BASIC CIVILIAN UNIFORM

The basic civilian uniform, for those uniformed civilians not placed in specialized uniforms by policy covered elsewhere in this Manual, shall be the following:

- Agency issued slate blue polo shirt with the Agency logo on the front;
- black / tan / navy pants (employee provided);
- black / brown shoes (employee provided);
- black / brown belt (employee provided); and
- black / tan or brown / navy socks (employee provided).

An optional burgundy long-sleeve polo shirt with the Agency logo on the front is approved for wear and is provided at the employee's expense.

The brown shoes, socks, and belt are to be worn with the tan pants only.

This uniform will be worn by ITD, Communications, and Police Station Technician civilian employees. Police Communications Supervisors and Police Station Technician Supervisors will wear Agency-issued maroon short-sleeve polo shirts with the logo on the front.

**NOTE:** The pants required for this uniform are to be worn so that the bottom of the leg touches the shoe, at the back of the heel, approximately one (1) inch above the floor. Pants legs shall be straight cut (no form-fit or stretch material). Pants material may not be denim, canvas, or corduroy.

### 3-591 ALTERNATE UNIFORM DESCRIPTIONS

The following sections describe the supplemental uniforms of the Agency and how they shall be worn. They shall be of a style and color as authorized by an Assistant Sheriff and approved by the Sheriff.

#### 3-591.1 K-9 BDU

The K-9 BDU is an alternate uniform which is authorized for K-9 handlers as a normal duty uniform. When this uniform is worn, the Garrison belt may be worn with the authorized holster in lieu of the Sam Browne belt. On-duty K-9 handlers summonsed to appear in court may wear their normal on-duty K-9 BDU uniform. The K-9 BDU is not authorized for court appearances if the K-9 handler is in an off-duty status or for secondary employment.

This uniform consists of the following:

- BDU style shirt with Agency shoulder patch on left sleeve and authorized K-9 Unit patch on right sleeve;
- BDU style trousers;
- nylon Garrison belt;
- nylon Sam Browne belt with accouterments;
- embroidered breast badge;
- embroidered nameplate;
- embroidered special unit insignia;
- socks;
- authorized footwear; and
- baseball cap.



Administrative and Operational Manual

September 12, 2022

### 3-591.2 CORRECTIONS ERT BDU

The Corrections ERT BDU is an alternate duty uniform for members of the ERT Team. This uniform consists of:

- BDU shirt with:
  - shoulder patches (Agency patch on left sleeve, Corrections ERT patch on right sleeve);
  - cloth name strip;
  - cloth corrections badge patch, and
  - cloth ERT strip (2" below cloth badge);
  - BDU trousers;
  - nylon equipment belt with approved accessories;
  - socks; and
  - authorized footwear.

### 3-591.3 SWORN OFFICER BDU

The Sworn Officer BDU is a practical alternative for special tactical operations or severe weather. This uniform may be worn by those personnel working the evening and midnight shifts. This uniform may also be worn as directed by a command officer during periods of severe weather or such tactical operations as it may be approved for in the instant case. This uniform consists of:

- BDU shirt with shoulder patches, with:
  - cloth Agency badge;
  - black name tape with gold embroidered first initial and last name, at officer's expense;
  - authorized collar brass;
  - cloth chevrons on sleeves;
  - collar rank insignia worn by only Lt., Cpt., Maj., Lt. Col., and Sheriff;
  - black t-shirt (if visible), or mock turtleneck dickie;
- BDU trousers;
- Agency ball cap;
- Sam Browne / equipment belt;
- Garrison belt with approved holster (may be worn when authorized by a Command officer).

The following units are permitted to blouse the BDU pants: K-9, EST, and ERT. No other groups / individuals will blouse BDU pants without prior approval from the Assistant Sheriff. Submitted requests to wear BDU pants bloused should include detailed justification.

### 3-591.4 SCHOOL RESOURCE OFFICERS ALTERNATE UNIFORM

School Resource Officers may wear an alternate uniform for select occasions, to be worn as authorized by the division commander and approved by the Sheriff, at officers' expense:

- Cargo pants;
- Shirt, polo pullover (short sleeve with patches and badge sewn on; rank displayed on sleeves);
- Black boots;



Administrative and Operational Manual

September 12, 2022

- Web gear belt.

### 3-592 AUTHORIZED UNIFORMS OF THE DAY

The dress uniform may be worn the entire year. On April 1 of each year, the uniform of the day will change from winter uniforms to summer uniforms. Per the MOU, from March 16 through March 31, it is within the discretion of the individual officer whether to wear short sleeves or long sleeves. On November 1 of each year, the uniform of the day will change from summer uniforms to winter uniforms. From November 1 through November 15, it is within the discretion of the individual officer whether to wear short sleeves or long sleeves.

Police Station Technicians at the various district stations will be notified by the Patrol operations commanders or designees, of any exceptions to this policy. This notification shall be made at least one hour before the beginning of the particular shift. It is the responsibility of all uniformed personnel to check with a police station technicians to determine the proper uniform to wear for each shift.

The EST uniform may be worn by EST members at the beginning of their tour of duty if an assignment is scheduled to begin within two hours of the beginning of their regularly scheduled shift. EST members may also remain in the EST uniform until the end of their tour of duty when an assignment concludes within two hours of the end of that officer's regularly scheduled shift. For plain clothes assignments, this will be at the discretion of the officer's commanders.

The Assistant Sheriffs have the authority to change the uniform of the day or to make additional changes to this policy.

### 3-593 ATTIRE FOR PLAIN CLOTHES OFFICERS

Plain clothes officers conducting operations not requiring an inconspicuous appearance or disguise shall wear civilian business attire consisting of the following:

- Males - suit or sports jacket and slacks, shirt and tie;
- Females - suit, dress, skirt, or slacks and blouse.

Plain clothes officers conducting covert activities may dress appropriately for their assignment, with division commander approval.

### 3-594 COURT ATTIRE

The Dress, Winter and Summer uniforms are acceptable court attire. In lieu of a uniform, male officers shall wear civilian business attire consisting of a suit or sports coat with complementary slacks, dress shirt, and a conservative tie. In lieu of a uniform, female officers shall wear civilian business attire consisting of a dress, skirt and blouse, or slacks outfit of a conservative nature. On-duty officers summoned to court without advance notice may appear in their normal on-duty attire. Outer garments and hats shall not be worn in the court room; they shall be secured in the court security office.



## Administrative and Operational Manual

September 12, 2022

### 3-595 CIVILIAN MEMBER UNIFORMS / ATTIRE

#### 3-595.1 UNIFORMED CIVILIAN MEMBERS

##### 3-595.1.1 BASIC CIVILIAN UNIFORM

The basic civilian uniform, for those uniformed civilians not placed in specialized uniforms by policy covered elsewhere in this Manual, shall be the following:

- Agency-issued slate blue polo shirts with the Agency logo on the front (short and long sleeve);
- Agency-issued burgundy polo shirts with the Agency logo on the front for supervisors (short and long sleeve);
- black / tan / navy pants (employee provided or requested through the Quartermaster);
- athletic shoes or black / brown shoes (employee provided);
- black / brown belt (employee provided); and
- black / tan / brown / navy socks (employee provided).

This uniform will be worn by IT, Fleet, Quartermaster, Communications, and Police Station Technician civilian employees. Police Communications Supervisors and Police Station Supervisors will wear Agency-issued burgundy polo shirts with the logo on the front.

##### 3-595.1.2 TRAINING DIVISION

Uniformed civilian members of the Training Division shall wear the following:

- Agency-issued red polo shirt;
- Tan pants (employee provided); and
- Black / brown shoes or boots (employee provided).

##### 3-595.1.3 FORENSIC SCIENCE SECTION AND DIGITAL FORENSICS UNIT

Uniformed civilian members of the Forensic Science Section and the Digital Forensics Unit shall wear the following:

- Agency-issued black polo shirt;
- Agency-issued tan pants; and
- Black / brown shoes or boots (employee provided).

**NOTE:** The pants required for this uniform are to be worn so that the bottom of the leg touches the shoe, at the back of the heel, approximately one (1) inch above the floor. Pants legs shall be straight cut (no form-fit or stretch material). Pants material may not be denim, canvas, or corduroy.

Uniform guidelines for the MSP Forensic Chemist position will be dictated by MSP policy.

#### 3-595.2 NON-UNIFORMED CIVILIAN MEMBERS

##### 3-595.2.1 PROFESSIONAL BUSINESS ATTIRE

In most cases, unless otherwise directed, employees attending formal meetings where they are officially representing the Agency shall wear attire that presents a professional business image.

Professional business attire for male employees is:

- a dress shirt and tie with a business suit; or



Administrative and Operational Manual

September 12, 2022

- a dress shirt and tie with an appropriate sport coat and dress slacks; and
- dress shoes.

Professional business attire for female employees is:

- a dress blouse or sweater with dress slacks or a business suit; or
- a dress blouse or sweater with an appropriate sport coat and dress pants or skirt (no higher than 3 inches above the knee when standing); or
- a dress (no higher than 3 inches above the knee when standing); and
- dress shoes.

### 3-595.2.2 CASUAL BUSINESS ATTIRE

Casual business attire, as outlined in this policy, offers an alternative to the professional business attire of dresses, suits, ties, and dress shoes. Personnel shall take their daily schedule into account when deciding how to dress for the day.

Listed below is a general overview of some of the more common items that are not appropriate. The list is provided as a general guideline to assist employees in making an intelligent choice. A good rule of thumb is that if unsure whether something is acceptable, choose something else or inquire first.

Civilian members are prohibited from wearing the following:

- Shorts, sweatpants, leggings, jeans and slacks styled like jeans, any type of cut-off pant, form-fitting pants or unhemmed slacks.
- Skirts and dresses more than 3 inches above the knee and/or with slits higher than 3 inches above the knee.
- Sweatshirts, tank tops, or t-shirts.
- Flip-flops (beachwear), foam/plastic clogs (such as Crocs) and slippers.
- Low or revealing necklines, transparent / sheer clothing, halters, spaghetti straps, midriff-baring tops, tube tops, leisure wear, sleepwear, and pajama-style clothes.
- Hats or coverings of an unusual or immoderate nature and those with potentially offensive lettering, symbols, or logos. Hats and other non-religious head coverings should not be worn indoors at Sheriff's Office facilities during work hours.

Civilian employees attending training or other official functions within the Agency will wear clothing appropriate to the activity as prescribed by the organizer of the function. Civilians required to perform other-than-normal office duties, or whose immediate work may dictate a deviation from this policy, may be allowed to wear clothing appropriate to those other-than-routine duties with the approval of their division commander. With prior Agency and/or division commander approval, casual business attire may include jeans and athletic shoes for Agency sanctioned events, such as casual Fridays, employee appreciation picnics and National Night Out. Exceptions approved by division commanders will be made for specific events only and not as a continuing course of conduct.

Directors, Deputy Directors, and personnel in Media Relations, the Office of Professional Responsibility and the Office of General Counsel are required to wear professional business attire. These employees may be approved to wear casual business attire only during Agency sanctioned events, excluding casual Fridays.

If an item of clothing is deemed to be inappropriate by a supervisor or commander / director, the employee may be

**Administrative and Operational Manual****September 12, 2022**

sent home to change clothes and will be given a verbal warning for the first offense. Progressive disciplinary action will be taken for further policy violations.

**3-596 RECOGNITION OF YEARS OF SERVICE**

The dedication, loyalty and contributions of time and effort by employees who remain in the service of the Office of the Sheriff for a number of years, are valuable resources, which deserve recognition. The Sheriff has, therefore, established a Service Recognition Program, which includes the components described in the following subsections.

Years of service are defined as those years of employment, from date of hire, in any capacity, as a full-time, full-time reduced-hours or part time employee. Any break in service shall not be credited, except for those required by active duty service, in the United States Military Services, during time of war or conflict.

**3-596.1 SERVICE MEDALS FOR UNIFORMED EMPLOYEES**

Each employee who wears a uniform in the course of the employee's Agency duties shall be presented a medal to display upon the employee's uniform. The service medal will be displayed in the manner described in this Manual for the display of all medals. The medals shall be issued at the intervals and in the form which follows:

- 2 years - a black ribbon with three strips at each end, the outermost strips red, the middle strips blue and the innermost strips gold;
- 5 years - the two-year ribbon with a gold star in the center;
- 10 years - the two-year ribbon with two gold stars centered vertically, having the same space between the stars horizontally as is between the stars and the end strips;
- 15 years - the two-year ribbon with three gold stars centered vertically, having an equal space horizontally between the stars and the end strips;
- 20 years - the two-year ribbon with four gold stars centered vertically, having an equal space horizontally between the stars and the end strips;
- 25 years - the two-year ribbon with a circular cluster of five stars centered vertically and horizontally; and
- 30 years - the two-year ribbon with a circular cluster of six stars centered vertically and horizontally.

**3-596.2 CIVILIAN ATTIRE SERVICE AWARD**

All personnel shall be presented a Service Award which may be worn with civilian attire, both at, and away from, work. The wearing of this Award is at the employee's discretion. Employees who may have an operational need to be unnoticed or undetected as employees of the CCSO, shall not wear this Award in any manner which would compromise that operational need.

The Award consists of a small replica of the Agency Flag with a rectangular pad below which is inscribed with a number equal to the years' service as described for service medals in the preceding section.

**3-596.3 PRESENTATION OF AWARDS**

Service Awards will be presented on a monthly basis to those employees who have completed the appropriate number of years of service during the preceding month. Service Awards for 2 and 5 years shall be presented by the employee's supervisor. Those for 10 and 15 years shall be presented by the employee's division commander



**Administrative and Operational Manual**

**September 12, 2022**

---

/ director. The awards for 20, 25, and 30 years may be presented by the Sheriff. All awards will be accompanied by a certificate of appreciation. The Human Resources Section will administer the Agency Service Awards.

All initial issues of awards will be at the expense of the Agency. Lost or damaged awards may be replaced in accordance with current policy for the particular employee. Replacement awards may be purchased by the employee from the Human Resources Section, if one is not replaced by policy, at the Agency's expense. When a Service Award is replaced by a subsequent one for a greater number of years, the employee may retain the replaced award as a memento. However, only the most recently received Service Award may be worn.





## Administrative and Operational Manual

September 12, 2022

## 3-600 DISCRIMINATION AND HARASSMENT

Personnel of the Charles County Sheriff's Office will at all times and in all places conduct themselves in a manner which respects the basic dignity and worth of all persons. This consideration applies to dealing with clients and associates of the Charles County Sheriff's Office, and it also applies to the personnel within the Agency, as they deal with each other.

Arbitrary discrimination and harassment are wrongful activities which have no place in a professional law enforcement Agency. In most cases, such activities are illegal, and in all cases they are detrimental to the function and purpose of the Charles County Sheriff's Office. These activities and actions are therefore prohibited for all personnel.

It is essential that the Sheriff's Office maintain a working environment in which all employees are provided fair and courteous treatment, and the opportunity to perform their duties free of arbitrary discrimination and harassment. Arbitrary discrimination and harassment undermine the integrity of employee relationships, lower employee morale, interfere with the efficiency and effectiveness of Agency operations, and may result in civil rights violation suits.

### 3-600.1 AGENCY POLICY

The personnel of this Agency shall conduct their affairs, responsibilities, and obligations in a manner which keeps them free from arbitrary discrimination and sexual harassment in accordance with the laws of the United States and the State of Maryland. Sheriff's Office personnel will provide fair and equal treatment to employees and citizens regardless of the person's race, color, religion, sex, age, national origin, ethnic group, marital status, sexual orientation, gender identity, genetic information, or disability unrelated in nature and extent so as to reasonably preclude the performance of the employment.

Arbitrary discrimination, sexual harassment, or any other form of harassment by a specific act, inference, or omission, by or against any employee or against a citizen, will not be permitted or condoned by the Sheriff.

### 3-600.2 DEFINITIONS

**Discrimination** - is an action or activity that unlawfully or unjustly results in unequal treatment of persons or groups based on age, color, national origin, race, gender, ethnic group, religion, or disability. Discrimination can occur overtly, covertly by an act or by an omission, and can exist in the following formats:

- **Disparaging Terms** - words used to degrade or infer negative connotations pertaining to age, color, national origin, race, ethnic group, religion, gender, or disability. Such terms may include slurs, symbols, posters, or insignia.
- **Other Verbal or Physical Conduct** - based upon an individual's age, color, national origin, race, ethnic group, religion, gender, or disability.

**Equal Employment Opportunity (EEO) Coordinator** - That individual within the Agency who has been assigned the responsibility to administer the provisions of this section. The EEO Coordinator is responsible to ensure that EEO law is fully and successfully implemented within the Agency. The EEO Coordinator is responsible for resolving complaints of discrimination and harassment wherever they may occur throughout the Agency. The person holding the position of Commander / Director, Administrative Services Division, is designated and assigned the responsibility as EEO Coordinator. The Deputy Director, Human Resources, is designated and assigned the responsibility as Assistant EEO Coordinator and will assist the EEO Coordinator in fulfilling the assigned duties and responsibilities.

**Harassment** - is intentional conduct which troubles, worries, or torments another person, providing that conduct is abnormal within the workplace. Conduct shall be presumed to be intentional if the offending employee has received previously documented counseling by supervisory authority concerning the undesirable nature of such conduct.



## Administrative and Operational Manual

September 12, 2022

Conduct will be presumed to trouble, worry, or torment, if it is documented that the offending person has been previously told the conduct was unwelcome, or perceived by the complainant as harassment. Conduct is considered not normal to the workplace if any supervisory authority has previously defined it as such in writing, or if the conduct is in violation of any policy of the Agency, or if the conduct is a violation of law.

**Prejudice** - is any set of rigid and/or unfavorable attitudes toward a particular group or groups which is formed with disregard for facts, i.e., an unsupported judgment, usually accompanied by disapproval.

**Racism** - is the incorrect assumption that a race determines specific cultural and psychological traits, with the belief that one race is superior to another. This belief of racial superiority allows discrimination to exist when dealing with other races believed to be inferior.

**Sexual Harassment** - is a form of sexual discrimination that involves the utilization of sexually explicit language or gestures; the presence of sexually suggestive or explicit pictures or drawings; unusual, unsolicited, or unwanted touching or closeness by another employee; or related conduct, activities, actions, mannerisms, or suggestions with sexual innuendos or overtones. Sexual advances, requests for sexual favors, and other verbal or physical conduct of a sexual nature constitute harassment when:

- The conduct is unwelcome and the employee does not solicit it, and the employee regards the conduct as undesirable or offensive. It may include these forms:
  - **Verbal** - innuendos, suggestive comments, slurs, jokes, propositions, or threats; and/or
  - **Non Verbal** - suggestive objects, pictures, suggestive or insulting sounds, whistling, or obscene gestures; and/or
  - **Physical** - includes touching, pinching, brushing the body, or assault.
- Submission to or rejection of such conduct is either explicitly or implicitly made as a term or condition of a person's job, pay, career, or employment decision.
- The conduct has the purpose of or effect of interfering with an individual's performance or creating an intimidating, hostile, or offensive working environment.

**Stereotyping** - is a preconceived or oversimplified generalization involving negative beliefs about a particular group or class of people. Negative stereotypes are frequently the basis for prejudicial attitudes and beliefs. Stereotyping overlooks people as individuals and categorizes them as members of a group that all think, act, and behave in the same manner and fashion.

### 3-600.3 GENERAL SUPERVISORY RESPONSIBILITIES

It shall be the responsibility of all persons in a supervisory or management position to at all times guard against harassment and arbitrary discrimination in the workplace.

Supervisors will take action to address any violations of policy they personally observe or that have been brought to their attention by utilizing the appropriate procedure(s) noted in the following sub-sections. All supervisors are reminded conduct prohibited by this section will generally diminish or disappear from the Agency when it is clear to employees such conduct will not be tolerated. All supervisors play a vital role in conveying this message by modeling appropriate behavior and addressing inappropriate behavior in a timely manner.

### 3-600.4 COMPLAINT HANDLING

The following procedures apply only to informal complaints. Because of restraints imposed by the Law Enforcement Officers' Bill of Rights, formal complaints against sworn officers must be handled consistent with the formal



## Administrative and Operational Manual

September 12, 2022

complaint procedures. Likewise, formally filed complaints against civilian employees will be handled in the manner of all formal complaints. It is the purpose of the procedures in this section to handle informal complaints in a more expeditious manner, with the main objective to quickly create a work environment which is free of harassment and arbitrary discrimination.

**External complaints** will be referred to a commissioned officer and handled in the manner outlined in the complaint policy elsewhere in this Manual. In addition to any action required of the commissioned officer, that officer shall, in all cases of alleged harassment or arbitrary discrimination, complete a Report of Discrimination / Harassment Form #58. This report will be forwarded to the Agency's EEO Coordinator. If a commissioned officer is not immediately available to talk with the complainant, the person receiving the complaint will document the complainant's name, address, telephone number, and a brief description of the incident which generated the complaint. The Report of Discrimination / Harassment will be used. If the name of the employee who is the subject of the complaint is known, this name will be noted.

The person receiving the complaint will assure the complainant that a commissioned officer will contact them. The Report of Discrimination / Harassment will be forwarded to the EEO Coordinator. The EEO Coordinator will, in consultation with the affected commander / director and the Commander, OPR, decide the best avenue of investigation for each such complaint. Available avenues would include:

- the supervisor of the employee against whom the complaint is filed; or
- other supervisory personnel; or
- criminal investigative personnel; or
- Internal Affairs personnel.

It is important that the immediate supervisor of the object employee be apprised of the complaint, unless that supervisor is a part of the complaint or there is an investigative purpose for withholding the information.

The initial inquiry and report will be completed within seven (7) calendar days of the receipt of the complaint. At a minimum, the complainant will have been contacted and any available witness interviewed. If the inquiry is not completed in seven (7) days, an initial report will be submitted outlining the circumstances of the incident and progress of the inquiry to date. A final report will be due at the end of a second seven (7) calendar day period unless written approval for an extension is granted by the Sheriff.

The inquiry report should, as a minimum, relate the details of the incident and recommendations for corrective action, including disciplinary action recommendations as may be appropriate. This report will be directed to the Sheriff for review and approval and will be returned to the EEO Coordinator for filing and/or disposition.

**Internal complaints** may be made by an employee to the employee's own supervisor, the supervisor of the offending employee, or any supervisor in either chain of command with whom the employee feels comfortable discussing the matter. Additionally, the employee may directly approach the EEO Coordinator or Assistant EEO Coordinator. In matters of equal opportunity, discrimination or harassment, these two officials may be consulted at any time without regard for the normal chain of command.

Supervisors and management personnel should be continually mindful of their responsibility to provide a workplace free from harassment and arbitrary discrimination. No complaint is needed to take action to rectify problems coming to their attention in this regard. Problems which continue after the supervisor or director is aware of the problem, or should have been aware of the problem, can provide vicarious liability for the supervisor, director, and the Agency. Equally important is the fact that such problems negatively affect morale and thereby degrade the efficiency and effectiveness of the Agency.

All personnel of the Charles County Sheriff's Office have a responsibility to avoid and/or correct situations involving discrimination or harassment. Any person who observes discrimination or harassment, which goes unresolved, will report the facts to his supervisor, someone else in his chain of command, or the EEO Coordinator or Assistant EEO Coordinator. Even though this policy places specific responsibilities for resolving cases of discrimination and harassment, it is every employee's responsibility to do whatever they are able to do, in order to promote a more



Administrative and Operational Manual

September 12, 2022

equitable work environment for all persons.

### 3-600.5 COMPLAINT RESOLUTION

Individuals should make others aware of events, circumstances, and remarks which are offensive to them personally and request their understanding. Many times people will be unaware that their actions and/or remarks are offensive. Given the insight that they are perceived as offensive, they will likely endeavor to prevent offending others.

In cases where individual action is ineffective, or where the behavior of the offending person is such that the complainant is uncomfortable approaching that person, the complaint may be taken to any level as outlined in Section 3-600.4. The objective is to educate and develop better interpersonal skills within the employees of the Agency. There is initially no requirement to discipline individuals who are the subject of such complaints if the matter is not criminal or a serious violation of rules of this Agency.

First line supervisors have the authority to resolve incidents of discrimination and harassment either observed or otherwise brought to their attention. If an incident requires immediate attention, the supervisor shall notify their Division Commander or Director of the incident, its nature and the parties involved, as soon as practical after handling the incident. If an incident does not require immediate attention, the supervisor shall notify their Division Commander or Director prior to taking action.

Upon being notified of a complaint, the Commander or Director will notify the EEO Coordinator. Contacting the EEO Coordinator allows the Agency to make the most accurate determination as to whether or not the complaint requires a formal investigation. If the parties involved are from different Divisions, then both Commanders or Directors of the parties involved will meet with the EEO Coordinator. Together they will discuss any prior history the offending employee might have related to harassment / discrimination policy violations and implement a plan of action to investigate the complaint. The reporting supervisor will be notified of the plan of action. Once the investigation is complete, a resolution will be decided upon with input from the EEO Coordinator and the Commander(s) or Director(s) before being implemented. The resolution decided upon will be implemented by the offender's Commander/Director.

Once implemented, the EEO Coordinator will follow up with the complainant as noted in this policy. The EEO Coordinator will use this information to establish a general knowledge of the Agency's performance in dealing with complaints of discrimination and harassment.

The EEO Coordinator will consult the complainant in all arbitrary discrimination and harassment cases after the case has been successfully resolved. The EEO Coordinator will apprise the complainant, at that time, of the Agency's intentions to keep the workplace free from arbitrary discrimination and harassment. The complainant will be invited to keep the EEO Coordinator informed concerning the effectiveness of the action taken to correct any discrimination or harassment which may have occurred. The EEO Coordinator will inform the complainant that there will be follow-up inquiries in order to continue the monitoring of the effectiveness of the Agency's actions. The EEO Coordinator will make follow-up checks at least twice during the year beginning at the completion of complaint resolution. The EEO Coordinator will document these follow-up conversations with the complainant and appropriate supervisory personnel.

The EEO Coordinator will keep statistical information concerning complaints and resolution of complaints. The EEO Coordinator will use this information to design training programs to remedy any areas which appear to be problematic within the Agency. The EEO Coordinator and the director of the Academy will collaborate in developing programs aimed at creating and maintaining a workplace free from discrimination or harassment, within the Charles County Sheriff's Office. It is anticipated that there will be, within all entry level training, a block of instruction concerning this subject.

No part of this policy is intended to abridge any right an employee or person may have to pursue complaints of discrimination or harassment through other avenues available. It is believed, however, that because this Agency is committed to a harassment and discrimination free workplace, the quickest and most effective way of dealing with these problems, should they arise, is within the Charles County Sheriff's Office.



**Administrative and Operational Manual**

**September 12, 2022**

**3-600.6 REPRISALS**

There shall be no reprisals or adverse action taken against an employee because that employee makes a harassment or discrimination complaint. Likewise, any person who participates in such complaint as a witness or reporting person, or who gives testimony in any proceeding regarding harassment or discrimination, is to be free of reprisal. In order to keep harassment and arbitrary discrimination from the workplace, all persons must feel comfortable in confronting these issues. The Sheriff is committed to providing a work environment which has that comfort.

**3-600.7 DISCIPLINARY ACTION**

Unresolved or gross misconduct in the area of harassment or arbitrary discrimination is considered a serious breach of organizational discipline. Those persons found to be in violation of this policy are subject to disciplinary action including dismissal. Should it become necessary to carry an action further than is covered by this section, the formal discipline policy will be used. In those cases, formal charges will be placed against the employee(s) who has / have demonstrated the offensive conduct and the case will be investigated in the manner of all formally charged cases. The Commander, OPR will be contacted for guidance in these cases. Criminal and civil sanctions are also possible under the laws of the United States and the State of Maryland.

**3-600.8 DISCRIMINATION & HARASSMENT TRAINING**

Discrimination and Harassment Training will be provided periodically to all employees. The Commander, Training Division will establish the curriculum and timing of such training. The Discrimination and Harassment policy will be reviewed with each employee by their supervisor, during their annual performance evaluation, as described in policy 3-653 Annual Harassment and Beneficiary Review.

New employees are informed during their new hire orientation the Agency has a zero tolerance policy for sexual harassment and discrimination of any type.



Administrative and Operational Manual

September 12, 2022

### 3-601 DOMESTIC VIOLENCE AND THE WORKPLACE

The Charles County Sheriff's Office is dedicated to the prevention and elimination of domestic violence. It seeks to create a supportive workplace environment in which employees feel comfortable discussing domestic violence and seeking assistance for domestic violence. The CCSO has a zero tolerance policy for domestic violence at the workplace and will take appropriate disciplinary action and/or criminal prosecution against any employee or non-employee who commits an act of domestic violence in CCSO offices, facilities, work sites, vehicles, or while conducting any CCSO business.

#### 3-601.1 DEFINITIONS

**Domestic Violence** - Abusive behavior whereby a person intends to establish and maintain power and control over a person with whom he or she has, or has had, a significant personal relationship. Power and control are exerted through physical, sexual, psychological, and/or economic means. Examples of domestic violence include, but are not limited to:

- intimidation;
- threats to cause harm;
- verbal harassment;
- disorderly conduct;
- crimes against property;
- violation of an ex parte or protective order;
- display or discussion of weapons;
- homicide;
- assault and battery;
- rape; and
- stalking.

**Perpetrator** - An individual who commits an act of domestic violence.

**Victim** - An individual who is subject to an act of domestic violence.

#### 3-601.2 CONFIDENTIALITY

In order to ensure the safety of all employees who comply with the law (including the Public Information Act), any information related to domestic violence or the Agency's response to specific domestic violence cases will only be disclosed on a need-to-know basis.

#### 3-601.3 WORK ENVIRONMENT

All employees should be sensitive and nonjudgmental when supporting victims of domestic violence.

An employee shall not be disciplined or penalized in the workplace for being a victim of domestic violence.

When an employee subject to discipline confides that the job performance or conduct problem is caused by domestic violence, the employee shall be referred to the County's Employee Assistance Program (EAP). The employee's participation in the County Employee Assistance Program (EAP) is voluntary.



Administrative and Operational Manual

September 12, 2022

### **3-601.4 DISCIPLINARY PROCEDURES FOR EMPLOYEES WHO COMMIT ACTS OF DOMESTIC VIOLENCE**

An employee who is found to commit an act of domestic violence in the workplace may be subject to disciplinary action, up to and including termination.

An employee who is found using any Agency resources such as work time, workplace phones, facsimile machines, mail, electronic mail, or other means to commit an act of domestic violence may be subject to disciplinary action, up to and including termination.

### **3-601.5 EMPLOYEE RESPONSIBILITIES**

All employees shall:

- attend Domestic Violence and the Workplace Training;
- immediately report to Agency sworn personnel any threats or acts of domestic violence in the workplace that may be experienced or witnessed (sworn personnel will take appropriate action as required in any incident of domestic violence); and
- notify a member of the Office of Professional Responsibility.

### **3-601.6 VICTIM RESPONSIBILITIES AND ASSISTANCE OPTIONS**

Employees who are victims of domestic violence shall:

- notify their supervisor of the possible need to be absent and discuss possible leave options;
- discuss with their supervisor plans to return to work and the appropriate reporting procedures;
- if necessary and available, make alternate arrangements to receive a paycheck;
- work with supervisor to ensure that adequate safety measures are in place; and
- contact the County's Employee Assistance Program (EAP) for confidential consultation and resources.

### **3-601.7 PERPETRATOR RESPONSIBILITIES**

Employees who are perpetrators of domestic violence shall:

- contact the County's Employee Assistance Program (EAP) office for confidential consultation and resources; and
- contact an abuser's intervention program.

### **3-601.8 SUPERVISOR RESPONSIBILITIES**

Supervisors shall:

- ensure that each employee is provided with a copy of this Domestic Violence Policy;



**Administrative and Operational Manual**

**September 12, 2022**

- participate in Domestic Violence and the Workplace Training;
- immediately refer any employee, known to be the victim or the perpetrator of domestic violence, to the Employee Assistance Program (EAP);
- report any instance of an employee perpetrator to the Office of Professional Responsibility; and
- maintain the confidentiality of all information related to an employee's involvement in a situation relating to domestic violence.

Supervisors shall post or convey to employees any materials regarding this subject, which are forwarded to them by the Agency for this purpose.

### **3-601.9 AGENCY EMPLOYEE ASSISTANCE PROGRAM COORDINATOR RESPONSIBILITIES**

The Agency Employee Assistance Program (EAP) Coordinator (Commander / Director, Administrative Services) shall:

- participate in Domestic Violence and the Workplace Training;
- maintain up-to-date referral resources on domestic violence hotlines, advocacy groups, shelters, counseling services and legal services (pro bono legal assistance and domestic violence / family court information);
- maintain up-to-date resources for perpetrators, including abuser's intervention programs; and
- maintain the confidentiality of all information related to an employee's involvement in a situation relating to domestic violence.

### **3-601.10 SAFETY**

Commanders of each component of the Agency shall make reasonable efforts to maximize safety of all employees. These efforts may include, but are not limited to:

- escort services;
- improved lighting;
- working closely with Criminal Investigations Division;
- relocation of employee's work station;
- installation of security cameras or silent alarms; and
- strict enforcement of current security procedures.





Administrative and Operational Manual

September 12, 2022

### 3-602 CHARLES COUNTY SHERIFF'S OFFICE CLASSIFICATION POLICY

The Charles County Sheriff's Office has established a classification plan, job analysis system, and assignment policies to provide equitable and adequate grades and wages for all Agency positions.

#### 3-602.1 DEFINITIONS

**Segment** - A group of job classes of various ranks and/or grades combined based on similar, overall job functions and duties. For purposes of the Charles County Sheriff's Office, employees are segmented into sworn, corrections, and civilian categories.

**Class** - A group of jobs for which duties, responsibilities, qualifications, and conditions of employment are sufficiently alike to justify the same treatment with respect to personnel practices. A class may be identified by rank for police and correctional officers and by grade and title for civilian employees.

**Job** - One or more positions with duties and responsibilities that are identical in all significant respects so that a single descriptive title can be used to identify the work done by those assigned.

**Job Description** - An official written document setting forth the duties and responsibilities of a job and the skills, educational requirements, and abilities required along with a basic explanation of the work environment.

**Job Task Analysis** - A systematic examination of the essential functions and objectives of each job as it relates to the knowledge, skills, and physical demands required to perform the tasks or duties of a particular job.

**Position** - The duties and responsibilities assigned to one employee. For purposes of comparison, a patrol officer assigned as a court security officer would occupy a position. Patrol officer would be the job. A position may have functional responsibility for a single task or over several tasks.

**Lateral Entry Officer** – An officer hired with previous work experience as a sworn police or correctional officer in another law enforcement agency or detention facility.

**Lateral Positions** - Full-time, regularly established positions to be filled by a sworn or correctional officer that are beyond the regular entry level positions. On-the-job and/or formal training may be provided as it becomes available, but does not preclude officers from selection for these positions prior to receiving training.

**Specialized Assignments** - Positions that are part-time or intermittent functions performed in addition to regular duties and that require specialized experience, training, or certification prior to assuming the duties associated with the assignment.

#### 3-602.2 POLICY

The Charles County Sheriff's Office is committed to providing a fair, impartial, and validated hiring and promotion system. The Agency is responsible for testing, hiring, discharging, and promoting all personnel employed.

The position classification system has been established to identify and define those positions necessary to meet the goals of the Sheriff's Office as set forth in Chapter 1 of this Manual.

#### 3-602.3 ADMINISTRATION

The Human Resources Section has the responsibility of developing and maintaining job specifications for each position classification. Human Resources will maintain records of all actions taken affecting positions and pay grades, provide for regular reviews to ensure all positions are properly classified, and recommend amendments to the classification system as necessary. These job specifications are updated as needed or when a position is being created.



## Administrative and Operational Manual

September 12, 2022

Job specifications are outlined in each position's job description. All position descriptions are approved by and are on file within the Human Resources Section. Position descriptions are available to all Agency personnel through Human Resources upon request. Amendments to the classification system require the approval of the Sheriff.

### 3-602.4 PROCEDURES

**Classification Plan** - The Classification Plan consolidates positions with similar duties, responsibilities, required knowledge, skills, and training into job classes. Class specifications include job, position, and rank titles.

The Charles County Sheriff's Office groups positions into classifications for salary and benefits purposes. The Agency also establishes:

- entry level salary amounts;
- salary differential ranges within ranks;
- salary differential ranges between ranks;
- compensatory time, holiday leave, and overtime policies; and
- other salary augmentation, if any.

**Job Descriptions and Review Cycles** - Every position within the Agency is provided with a written position description, to include written duty descriptions, physical demands, and responsibilities associated with the position. The Human Resources Section is responsible for ensuring job descriptions are developed for any new positions created and will modify and revise those which need to be changed.

Each employee of the Agency is provided a copy of his position description at the time of hire, during the performance evaluation review, and when significant changes of duties and responsibilities necessitate a revision of the job description.

Positions will be routinely evaluated every three years. One of the three segments (sworn, correctional, or civilian) will be reviewed each year. An out-of-cycle review may be requested for any position by a commander/ director who believes there has been a dramatic change in duties and/or responsibilities. Any employee who believes his position is improperly classified may request a job description review, also known as a desk audit, by sending a memorandum to the Commander/ Director, Administrative Services Division through the chain of command.

An increased volume of the duties and responsibilities already established in the job description will not be considered justifiable to initiate a reclassification. The request must contain sufficient information to validate the request by outlining new or increased duties, and any additional supervisory responsibilities. In no instance will any position be submitted for reclassification more than once in a 12-month period unless specific areas of the job have changed substantially since the previous submission.

If a job description review (desk audit) is authorized, a Job Information Questionnaire will be sent from Human Resources to the requester for completion within fifteen (15) days by the employee and their supervisor. Once Human Resources has compiled the information from the completed desk audit, it will be forwarded to the Commander / Director, Administrative Services Division for review and approval or disapproval by the Sheriff. The supervisor and employee will be notified of same. If approval is granted and funding is available, reclassification of the employee's position will take place as follows:

- Requests for position reclassification that are received and approved before October 1 of the current fiscal year will be submitted in the upcoming budget cycle / year. For example, approvals before October 1, 2017, will be considered for Fiscal Year 2019 (July 1, 2018 – June 30, 2019).
- Requests for position reclassification that are received or approved after October 1 of the current fiscal year will not be considered until the following budget cycle/ year. For example, approvals after October 1, 2017, will be considered for Fiscal Year 2020 (July 1, 2019 – June 30, 2020).



## Administrative and Operational Manual

September 12, 2022

Requests to establish new positions will include not only a Job Information Questionnaire, but also a draft position description outlining the essential duties, qualifications, education, and training skills needed, and the projected work environment under which the employee will be expected to perform.

Requests for new positions should be submitted to the Commander/ Director, Administrative Services Division no later than October 1 of each year in advance of the budget preparation. Requests for new positions will also be presented and substantiated by the requesting division commander/ director during the annual Strategic Management Program meeting.

**Position Evaluation** - Positions to be evaluated will be reviewed by a Position Evaluation Committee comprised of the Commander/ Director, Administrative Services Division; Deputy Director, Budgeting Section; and the Human Resources Administrator responsible for the position classification system. Tentative results will be discussed with the executive staff and more information gathered, if necessary. Results of the position review, along with a fiscal note, will be forwarded to the Sheriff for his approval before final notification is made to the respective division. Implementation of the results may be rejected or deferred based on the availability of budgetary funds.

Positions will be classified in the proper grade on the basis of the duties, responsibilities, and qualifications required as evaluated in terms of factors common to most jobs. The Position Evaluation System is a point factor system that evaluates each factor separately and assigns to each a numerical value according to how strongly that factor is represented. Factors are aspects of a job such as supervision received or exercised, skills and abilities required, complexity of work, impact of decisions made, internal and external contacts, mental demands, and hazards in the workplace or area.

**Job Task Analysis** - A written job task analysis is maintained in the Human Resources Section for every position. The job task analysis will include, but not be limited to:

- duties, responsibilities, functions, and tasks;
- the frequency with which each task is performed and the physical demands involved;
- minimum qualifications or level of proficiency necessary in the job and an understanding of the critical nature of the related skills, knowledge, abilities, and behaviors.

The Human Resources Section will conduct a job task analysis once every three (3) years to verify the validity of the current job descriptions for each position or when significant changes in the classes occur.

The objective of the job task analysis is to:

- serve as a basis for the position description and Classification Plan;
- provide guidance to members and their supervisors concerning the essential functions and physical demands of individual positions;
- assist in the establishment of the training curriculum; and
- provide a basis for minimum requirements in recruitment, examination, selection, appointment, promotion, and performance evaluation.

### 3-602.5 ENTRY LEVEL SWORN AND CORRECTIONAL POSITIONS

All police and correctional officer new hires will, upon their date of hire, hold the position of Police Officer I (PO I)/ Correctional Officer I (CO I). The positions of PO I and CO I are entry-level, probationary positions.

### 3-602.6 PROBATIONARY PERIODS

**ENTRANCE LEVEL PROBATION:** All full-time and full-time-reduced-hour employees will serve an entrance level probation period when newly hired or rehired by the Agency. The following probationary periods apply:



## Administrative and Operational Manual

September 12, 2022

- Sworn Police Officers, Court Security Officers, Automated Enforcement Unit Officers and Correctional Officers - from date of hire to one year after completion of formal entry level training needed to work as a solo officer. Formal entry level training includes the Academy or Comparative Compliance Training and Field Training Program (FTO).
- Civilian employees - one year from date of hire.

All entry level probationary employees will be made aware of the fact that their initial time interval in a position is probationary, and they will be informed of the intended length of the probation. This notification will be documented during an employee's initial Agency orientation. A copy of this notification, signed by the employee, will be placed in the employee's personnel file.

When any employee is unable to perform in an entry level capacity, their employment will normally be terminated. If, however, there is reason to believe the employment and training expenses justify the offer of another position within the Agency, that avenue may be explored. Only vacant positions within the Agency may be considered for this option.

**PROBATION AFTER PROMOTION:** An employee who is promoted to the next rank/ grade in the classification system will be required to serve in a probationary status for a period of one (1) year from the date of promotion. This probationary period will determine if the employee is able to perform at the new level and retain the new rank/ grade at the end of the period. Probation after promotion does not apply to the rank of POII.

At the end of the probationary period, the Sheriff may:

- grant permanent status; or
- extend the employee's probation to allow for an interim rating process to gauge whether or not sufficient progress has been made to warrant permanent status; or
- demote the employee to his previous rank / grade.

If an employee is unable to successfully complete the probationary period following a promotion and is demoted to his previous rank/ grade, he will not be required to serve a probationary period in the previous rank/ grade.

**PROBATION AFTER TRANSFER TO POSITION OF SWORN POLICE OR CORRECTIONAL OFFICER:** Any employee who transfers from any other position in the Agency to the position of sworn police officer or correctional officer will serve an Entrance Level Probation period as defined above, beginning with the date of transfer. This date is now their date of employment for purposes of rank and promotion.

**PROBATION AFTER TRANSFER TO NEW CIVILIAN POSITION:** A civilian employee who receives a new position in a pay grade above, below, or equivalent to his current position within the Agency, will serve an Entrance Level Probation period as defined above, beginning with the date of transfer.

If a civilian employee has been promoted to a new position, and while the employee is in a probationary status in that position the employee is found to be unable to satisfactorily perform in the new position, employment will normally be terminated. If, however, there is a vacant position within the Agency where the employee may function satisfactorily, then the employee may be offered that position. If the employee accepts the position, the employee will revert to the status and pay of this new position. The employee in these cases will lose all title, pay, and privileges associated with the former position.

**EXTENSIONS OF PROBATIONARY PERIODS:** Probationary period extensions will be initiated by the employee's division commander. The division commander will forward a written request with justification to the Sheriff and/or the appropriate Assistant Sheriff for disposition. Upon approval, the division commander will notify the employee in writing of any extension made to their probationary period.

Under extenuating circumstances where a probationary employee is not available for duty with the Agency during their probation period (for example: called for active military duty, an extended illness, etc.), entry level probationary



Administrative and Operational Manual

September 12, 2022

police and correctional officers may, upon their return to the Agency, be required to complete the remainder of their requisite entry level probationary period. This decision will be made at the discretion of the Sheriff or his designee.

### 3-602.7 OBTAINING PERMANENT STATUS

For any employee to gain permanent status at the end of a designated probationary rating period, the employee must earn a rating of Acceptable or above in all rating factors as documented on his most recent performance evaluation and be recommended for permanent status by his division commander/ director. A Permanent Status Request memorandum generated by the Human Resources Section, will be forwarded to the Sheriff via the employee's chain of command. The employee's release from probation will take place only after authorization of the Sheriff.

### 3-602.8 DUTY STATUS

All sworn police and correctional officers are presumed to be on full duty status, authorized and able to perform all of the essential functions of the position.

A sworn police or correctional officer may be placed on limited duty status as described in section 3-611.

A sworn police or correctional officer may be placed on non-officer status in the following situations:

- Emergency suspension;
- Suspension pending criminal or administrative investigation;
- Disciplinary suspension;
- Extended military leave;
- Medical conditions under 3-611.

Non-officer status means that the officer's police or correctional certification is temporarily suspended.

### 3-602.9 DESCRIPTION OF SWORN/CORRECTIONAL OFFICER CLASSES

The following is a summary of the sworn and correctional officer classes within the Charles County Sheriff's Office. Sworn and Corrections positions, Captain and above, and Master Corporals and Master Sergeants are appointed, non-competitive positions. The position of Lieutenant is the last permanent rank with the Agency. More detailed descriptions are contained in the job description for each class.

#### Lieutenant Colonel

This is the highest responsible senior administrative and supervisory authority of all employees of the CCSO. He is responsible to adhere to the directives of the Sheriff. The duties and responsibilities of this position are dictated by the Sheriff.

#### Qualifications:

- College level degree or any equivalent combination of experience and training which provides the required knowledge, skills, and abilities.
- Extensive law enforcement experience combined with management and administrative experience.

#### Major

A sworn officer in the position of Assistant Sheriff holds the rank of Major. The Agency has two Assistant Sheriff

**Administrative and Operational Manual****September 12, 2022**

positions, both of which may be held by a sworn officer. At the Sheriff's discretion, however, the Assistant Sheriff of Administration position may be held by a civilian employee. Assistant Sheriffs are responsible to fulfill the duties and responsibilities as dictated by the Sheriff, which include planning, instructing, assigning of duties, providing leadership to subordinate personnel, and monitoring their proficiency. The incumbent exercises considerable independence in the performance of duties.

**Qualifications:**

- College level degree or any equivalent combination of experience and training which provides the required knowledge, skills, and abilities.
- Extensive law enforcement experience combined with management and administrative experience.
- If sworn, must maintain Police/Correctional Officer certification through the Maryland Police Training and Standards Commission.

**Captain/Director (Sworn and Corrections)**

**Duties:** Work involves the responsibility of planning, instructing, and assigning duties to subordinate officers, providing leadership for them in the conduct of their work, and for checking their proficiency. The incumbent serves as the chief administrator for the division or assigned component and exercises considerable independence in the performance of duties, with only general guidance received from a superior. The Director, Corrections Division, is a correctional officer with comparable credentials and leadership abilities.

**Qualifications:**

- College level degree or any equivalent combination of experience and training which provides the required knowledge, skills, and abilities.
- Several years of experience in law enforcement/corrections, including some supervisory experience.
- Must maintain Police/Correctional Officer certification through the Maryland Police Training and Standards Commission.

**Lieutenant (Sworn and Corrections)**

**Duties:** This position involves responsibility for planning, instructing, and assigning duties to subordinates, providing leadership for them in the conduct of their work, and for checking their proficiency. Considerable independence is exercised in the performance of duties, and general guidance is received from the respective commander.

**Qualifications:**

- College level degree or any equivalent combination of experience and training which provides the required knowledge, skills, and abilities.
- Several years of experience in law enforcement/corrections, including some supervisory experience.
- Must maintain Police/Correctional Officer certification through the Maryland Police Training and Standards Commission.
- May be required to maintain certification with the Criminal Justice Information System (CJIS) for access into state and federal computer networks (METERS/NCIC).

**Master Sergeant (Sworn and Corrections)**

**Duties:** This position is that of an officer holding the rank of Sergeant with the appointed title of Master Sergeant who is responsible for first-line supervisory work. This title may be bestowed by the Sheriff if a Sergeant meets the minimum years of service requirements and passes a nomination and review process.

**Qualifications:**



Administrative and Operational Manual

September 12, 2022

- Must have been employed as a PO or CO for a minimum of 20 years;
- Must have held the rank of Sergeant consistently for a minimum of 7 years.

An applicant meeting the qualifications may submit a request to be considered and/or be nominated by his immediate supervisor by way of a detailed memorandum with written justification, copies of the last two evaluations, copy of the leave record, copy of all conference forms/disciplinary actions, and copy of statistics, if applicable, for the last twelve (12) months.

The nomination packet will be forwarded through the chain of command using the Inter-Office Memorandum Coversheet (Form 144), and each level of command will either endorse or not endorse the nomination. The nomination will then be reviewed by the Assistant Sheriffs. Each will either endorse or not endorse the nomination and forward the packet to the Sheriff. The Sheriff will review the information and approve or not approve the nomination.

**Sergeant (Sworn and Corrections)**

**Duties:** This position is responsible for first-line supervisory work. Work involves planning, assigning, overseeing, assisting, and evaluating the work of subordinate officers. This position can also include designing programs, preparing unit budgets, composing and reviewing reports, and maintaining records. Some assignments related to this position have the potential for personal danger and can involve dealing with many different levels of the criminal element. Considerable independence is exercised in the performance of duties, and general guidance is received from his respective commander.

**Qualifications:**

- Graduation from a recognized high school or possession of a General Educational Development (GED) certificate recognized by the Maryland State Board of Education;
- Must maintain Police/Correctional Officer certification through the Maryland Police Training and Standards Commission;
- May be required to maintain certification with the Criminal Justice Information System (CJIS) for access into state and federal computer networks (METERS/NCIC).

**Master Corporal (Sworn and Corrections)**

**Duties:** This position is that of an officer holding the rank of Corporal with the appointed title of Master Corporal. This title may be bestowed by the Sheriff if a Corporal meets the minimum years of service requirement and passes a nomination and review process.

**Qualifications:**

- Must have been employed as a PO or CO for a minimum of 15 years;
- Must have held the rank of Corporal consistently for a minimum of 5 years.

An applicant meeting the qualifications may submit a request to be considered and/or be nominated by his immediate supervisor by way of a detailed memorandum with written justification, copies of the last two evaluations, copy of the leave record, copy of all conference forms/disciplinary actions, and copy of statistics, if applicable, for the last twelve (12) months.

The nomination packet will be forwarded through the chain of command using the Inter-Office Memorandum Coversheet (Form 144), and each level of command will either endorse or not endorse the nomination. The nomination will then be reviewed by the Assistant Sheriffs. Each will either endorse or not endorse the nomination and forward the packet to the Sheriff. The Sheriff will review the information and approve or not approve the nomination.

**Corporal (Sworn)**



## Administrative and Operational Manual

September 12, 2022

**Police/Correctional Officer First Class  
Police/Correctional Officer I and II**

**Duties:** These sworn positions involve general police work pertaining to the enforcement of all applicable statutes and laws within the jurisdiction of Charles County. This may include crime prevention, investigation and detection, protection of life and property, traffic control, and maintaining law and order in the County. These corrections positions involve entry level work responsible for the supervision, custody and security of inmates in the Charles County Detention Center. Work related to these positions has the potential for personal danger and involves working with all levels of the criminal element. Officers receive direction from supervisors and carry out their assignments in accordance with established operating procedures, yet must be able to act without direct supervision and be able to provide supervision to subordinate officers in the absence of other supervisory authority.

**Qualifications:**

- Graduation from a recognized high school or possession of a General Educational Development (GED) certificate recognized by the Maryland State Board of Education.
- Sworn officers must be United States citizens and shall be 21 years of age or older at the time of certification by the Maryland Police Training and Standards Commission (MPTSC);
- Correctional officers must be United States citizens and shall be 18 years of age or older at the time of certification by the MPTSC;
- Must graduate from an accredited training academy and qualify and maintain Police/Correctional Officer certification through the MPTSC.

**Corporal (Corrections)**

**Duties:** This position is responsible for first line supervisory work as assigned. Work involves planning, assigning, overseeing, assisting, and evaluating the work of subordinate officers. This corrections position involves entry level work responsible for the supervision, custody and security of inmates in the Charles County Detention Center. This position can also include designing programs, providing input into unit budgets, composing and reviewing reports, and maintaining records. Work assignments related to this position have the potential for personal danger and can involve dealing with all levels of the criminal element. Considerable independence is exercised in the performance of duties, and general guidance is received from their respective commander. Officers receive direction from supervisors and carry out their assignments in accordance with established operating procedures, yet must be able to act without direct supervision and be able to provide supervision to subordinate officers in the absence of other supervisory authority.

**Qualifications:**

- Graduation from a recognized high school or possession of a General Educational Development (GED) certificate recognized by the Maryland State Board of Education;
- Must maintain Correctional Officer certification through the Maryland Police Training and Standards Commission (MPTSC);
- May be required to maintain certification with the Criminal Justice Information System (CJIS) for access into state and federal computer networks (METERS/NCIC).

**3-602.10 APPOINTED POSITIONS**

The following positions in the Agency are appointed by the Sheriff and serve at his pleasure. These appointments are temporary in nature and employees in them may be removed with or without cause by the Sheriff.

Sworn police and correctional officers who are appointed to positions are entitled to retain their tenure in the last permanent rank held. They may retreat to that last permanent rank in the event they are removed from an appointed rank, provided they are not the subject of a disciplinary action or were not terminated from the Agency.





Administrative and Operational Manual

September 12, 2022

---

**Sworn Police Officers**

The ranks of Captain and above are appointed positions. The highest permanent rank within the Agency is Lieutenant.

**Sworn Correctional Officers**

The ranks of Captain, Deputy Director, and Director are appointed positions. Selections to fill the position of Captain and Deputy Director shall be made from within the Agency. Selections to fill the position of Director may be made from within or outside the Agency. The highest permanent rank within the Corrections Division is Lieutenant.

**Civilian Employees**

The civilian positions of Chief of Staff, Director and General Counsel are appointed positions. Selections to fill these positions may be made from within or outside the Agency.

**3-602.11 LATERAL POSITIONS WITHIN THE CHARLES COUNTY SHERIFF'S OFFICE**

Lateral positions are full-time, regularly established positions to be filled by a sworn or correctional officer that are beyond the regular entry level position. On-the-job and/or formal training may be provided as it becomes available, but does not preclude officers from selection for these positions prior to receiving training. The following positions, Sergeant and below, have been identified as lateral positions:

**Office of the Sheriff**

- Internal Affairs;
- Standards, Inspections, and Safety Officer.

**Patrol Operations (North/ South Divisions)**

- Patrol Operations.

**Criminal Investigations Division**

- Persons/Property Crimes;
- Narcotics Enforcement;
- Forensic Science;
- Homeland Security & Intelligence.

**Special Services Division**

- Domestic Violence;
- Civil;
- Child Support Enforcement;
- Warrant/ Fugitive;
- Courts/ Judicial Security; and
- Property Held.

**Special Operations Division**

- Traffic Operations;
- Crime Prevention;
- Community Policing;



Administrative and Operational Manual

September 12, 2022

- School Resource Unit; and
- Alcohol Enforcement.

**Administrative Services Division**

- Pre-employment/ Recruitment Unit.

**Training Division**

- Southern Maryland Criminal Justice Academy.

**Corrections Division**

- Custody and Security;
- Work Release;
- Transport;
- Court Security;
- Classification;
- Intake;
- Security Maintenance;
- Administrative Hearings;
- Commissary and Supply Services;
- Academy Staff Instructor; and
- Intelligence.

**3-602.12 SPECIALIZED ASSIGNMENTS**

Specialized assignments are part-time or intermittent functions performed in addition to regular duties and that require specialized experience, training, or certification prior to assuming the duties associated with the assignment. The following positions have been identified as specialized assignments within the sworn ranks of the Charles County Sheriff's Office:

- Emergency Services Team (EST) Members;
- Crisis Negotiators;
- Honor Guard Members;
- Motorcycle Operators;
- Intoximeter Operators;
- Drug Recognition Experts;
- Firearms Instructors;
- Polygraph Examiners;
- Security Response Vessel Operators/ Crew Members;
- Unmanned Aerial System (UAS) Pilots;
- Search Managers;
- Special Events Response Team (SERT) Members; and
- K9 Handlers; and
- Tactical Response Team (HAZMAT) Members.

The following positions have been identified as specialized assignments within the correctional ranks of the Charles County Sheriff's Office:

- Honor Guard;
- Security Enforcement Team;
- Emergency Response Team (ERT);



Administrative and Operational Manual

September 12, 2022

- Duly Authorized Inspector;
- UAS Pilot;
- Search Managers;
- Firearms Instructor; and
- Fire Marshal.

Based on written evaluations provided by each commander/ director under whose command a specialized assignment falls, the Commander/ Director, Administrative Services will conduct a review to determine if each assignment should be continued, changed or abolished. This annual review will include the following information and will be presented to the Sheriff each April:

- a list of all special assignments;
- a statement of the purpose for the assignment; and
- an evaluation of the initial problem or condition that required the implementation of the specialized assignment.

Anticipated openings for these specialized assignments and any newly created specialized assignments will be announced Agency wide. Selection criteria will be based on required specialized experience, training or certification. The selection process consisting of a review of qualifications and interviews will consider all applicants who meet the established criteria.

### 3-603 COLLECTIVE BARGAINING

Maryland Code, Courts and Judicial Proceedings, Title 2, allows for sworn law enforcement officers and correctional officers of the Charles County Sheriff's Office, at the rank of Sergeant and below, to organize and bargain collectively in good faith with the Sheriff or the Sheriff's designee concerning the following matters:

- compensation, excluding salary, wages, and those benefits determined, offered, administered, controlled, or managed by the County Commissioners of Charles County;
- leave, holidays, and vacations; and
- hours, working conditions, and job security.

The law also provides that a sworn law enforcement officer or correctional officer who is a member of a bargaining unit with an exclusive representative may discuss any matter with the employer without the intervention of the exclusive representative.

#### 3-603.1 NEGOTIATIONS

The Charles County Sheriff's Office is committed to bargaining in good faith with the duly recognized collective bargaining unit representing the sworn and corrections employees of the Agency. The Agency is committed to abiding by any ground rules established for negotiations that arise out of the collective bargaining process or any agreed to arbitration proceedings. Ground rules may include, but not be limited to, the following:

- location of the meetings;
- time schedules and meeting agendas;
- methods for recording sessions, if any;
- methods for introducing issues;
- methods for resolving any conflict; and
- procedures for release of information.

The Agency will abide, in both letter and spirit, by the negotiated agreement that has been signed by management and employee representatives and then ratified by the Sheriff and the recognized bargaining unit.



**Administrative and Operational Manual**

**September 12, 2022**

The Sheriff is responsible for the composition and organization of the bargaining team representing the Agency. The Sheriff will designate at least one, but not more than three individuals to represent the Agency in negotiations. The Chief of Staff will be designated to act as the principal negotiator for the Agency.

The Fraternal Order of Police (FOP) Lodge 24 has been duly certified and is recognized as the exclusive bargaining unit representing sworn personnel at the rank of Sergeant or below. The FOP shall designate at least one, but not more than three individuals to represent them during negotiations.

Designated representatives shall meet at reasonable times and engage in good faith bargaining. Negotiations shall begin on or before each July 1 of the year before the expiration of any existing agreement.

In accordance with Maryland Law, the State Government Article, negotiations or matters relating to negotiations, shall be considered closed sessions. The parties shall make every reasonable effort to conclude negotiations in a timely manner so as to allow for any agreements made, to be included in the Charles County Sheriff's Office budget request to the County Commissioners.

**3-603.2 AGREEMENT AND RATIFICATION**

To the extent any matters negotiated between the Charles County Sheriff's Office and the collective bargaining unit requires legislative approval or the appropriation of funds, the matters shall be recommended to the General Assembly for approval of legislation or to the County Commissioners for appropriation of funds. Any agreement reached is not valid if it extends for less than 1 year or for more than 2 years.

Any agreement reached shall contain all matters concerning the terms agreed upon during the process. The agreement shall be in writing and signed by the designated representatives of the Sheriff's Office and of the exclusive representative involved in the bargaining negotiations. An agreement or any modifications thereof is not effective until it is ratified by the Sheriff and by a majority vote cast by members of the FOP.

**3-603.3 DISSEMINATION AND IMPLEMENTATION**

In order to comply with any changes brought about by the ratification of a new agreement, it is essential that Agency policies and procedures be reviewed and amended as needed to conform with language in the negotiated agreement. Therefore, once an agreement is ratified by all parties, the Sheriff or a designee will:

- obtain a written, signed copy of the labor agreement;
- disseminate information relative to the new agreement, including modifications to existing agreements, to commanders and supervisors of bargaining unit members; and
- send a copy to the Deputy Director, Planning & Accreditation to review and amend, if necessary, all written policies and procedures to coincide with the terms of the agreement.

The Agency will ensure that each represented employee receives a copy of any new written agreement.

**3-605 COMPENSATION**

The Sheriff recognizes the benefit of providing employee compensation based upon the amount and level of the service rendered to the community. In providing compensation, the Agency seeks to balance the needs of employees with the requirement that the organization accomplish its mission and fulfill its obligations to the public. All employees of the Sheriff's Office must keep this balance in mind as they consider the compensation policies of the Agency. The citizens of Charles County have a right to expect availability of services, in quantity and quality.



## Administrative and Operational Manual

September 12, 2022

### 3-605.1 DEFINITIONS

The following terms have the defined meanings for purposes of this Manual Section:

**Critical Employees** - Employees whose services are considered essential during their assigned work hours. These employees must report for work in circumstances when some other Sheriff's Office and Charles County employees do not.

**Operational Employees** - Employees whose services are necessary to the 24-hour operation of the Agency, but by job description are not critical personnel. These employees must report for work based on the directives of division commanders / directors who will establish in advance minimum staffing levels for their units.

**Non-Critical Employees** - Those employees generally assigned to a position within the Agency that by the nature of their position description are considered non-essential if emergencies occur during their scheduled work hours. These employees are in most cases assigned to normal business hours Monday through Friday.

A representative list of the above employee classifications can be obtained from the Administrative Services Division, Human Resources Section.

**Exempt Employee** - An employee who is exempt from the requirements of the Fair Labor Standards Act because of that employee's job within the organization. Exempt status is determined by the nature of the duties assigned to a particular position and not by the rank or pay grade of the individual. Exempt employees are not entitled to overtime pay. When job descriptions are reviewed, modified, or created, they shall be examined by Human Resources to determine if they meet the standard for exempt employees. This determination shall be noted on the job description. Employees shall remain classified exempt or non-exempt as they were on the effective date of this policy or until their position description is reviewed, modified, or newly created.

**Non-Exempt Employees** – Are those employees not designated as exempt employees under the Fair Labor Standards Act, due to their positions within the Agency.

**Police Recruit** – An employee hired as a police officer candidate is considered to be a Police Recruit prior to and while attending the mandated entrance level training academy as approved by the Maryland Police Training & Standards Commission (MPTSC). Upon completion and graduation of the mandated entrance level training academy, the Police Recruit's title will be changed to Police Officer I (POI).

### 3-605.2 PAY SCALES

Pay scales are developed by the Deputy Director, Budgeting Section for both sworn and civilian personnel. Generally, the pay of sworn personnel is fixed by law upon Maryland State Police pay scales. Civilian pay scales are created by the Sheriff and reviewed by Charles County Government. Part-time civilian and correctional officer scales are created by the Sheriff's Office, and recommendations are provided to the County Commissioners during budget review. Employees should contact the Deputy Director, Budgeting for answers to questions related to pay scales. For individual pay rates or pay schedules, employees should contact the Deputy Director, Accounting. The Deputy Director, Planning & Accreditation will have a Special Order generated for addition to the AOM describing new and amended pay scales.

### 3-605.3 PAYCHECKS

Paychecks are distributed bi-weekly to the employee, either in paper format or by direct deposit by the Charles County Payroll Office. Paper checks will be released only to the employee whose name appears upon the check. Should there be a need to release the check to someone other than the employee, contact should be made with the County Payroll Office by the employee in order to provide official authorization of this process. A link to the Charles County Government Payroll Portal is available on the Agency Intranet and on the County website to provide information regarding pay, deductions, taxes, etc.



## Administrative and Operational Manual

September 12, 2022

### 3-605.4 DUTY HOURS

Full-time sworn officers and correctional officers working in custody and security are exempt from the forty (40) hour work week mandated by the Fair Labor Standards Administration, and are placed on a twenty-eight (28) day work schedule per the FLSA 7K exemption. Sworn and correctional officers shall be eligible for overtime pay for all hours worked over those scheduled.

All non-exempt critical civilian employees are expected to work forty (40) hours per week and eighty (80) hours per pay period. No more than forty (40) hours per work week may be scheduled without compensating the employee at time and one-half the employee's hourly rate for all hours worked over forty (40) in a seven (7) day pay period. These employees shall be eligible for overtime pay or compensatory time for all hours worked over forty (40) hours.

Non-critical and operational employees are expected to work a seven and one-half (7.5) hour day, seventy-five (75) hours per pay period. These employees shall be eligible for overtime pay for all hours worked over forty (40) in one week.

There is some flexibility available in scheduling the duty hours of non-critical personnel; however, changes must be approved by division commanders / directors.

The New Duty Hour Request Form #300, available from Human Resources, will be used by a non-critical employee to request a change of duty hours. This form will be submitted through the chain of command to the employee's division commander / director.

Full-Time Reduced Hours (FTRH) employees are designated as critical, non-critical, or operational employees as indicated in the position description for their particular assignment. FTRH employees are expected to work thirty-two (32) hours per week, sixty-four (64) hours per pay period.

Part-Time employees are expected to work a twenty-four (24) hour work week, forty-eight (48) hours per pay period.

Work schedules, time records, and earning records must be retained for a period of three (3) years after employee termination. Records will be maintained on authorized time keeping, leave record, and overtime request formats. Exempt and non-exempt employees will record the hours they work each day. Premiums earned during the week such as overtime, shift differential, on-call premiums, or emergency overtime must be noted and justification provided for non-exempt employees. If authorized by the Sheriff, documentation must be submitted for any compensatory time and/or overtime earned for exempt employees. Accounting Section personnel will input the data into the County's automated payroll system.

#### 3-605.4.1 COMPRESSED WORK SCHEDULE PROGRAM

A voluntary compressed work schedule program is available to full time non-critical civilian staff. Critical and full time reduced hours staff are ineligible. Operational staff may be considered on a case by case basis, depending on the needs of the Agency. Employees will be permitted to participate so long as there is adequate work and appropriate coverage of offices and operations as determined and approved by the commander / director / deputy director of the section / division. A commander / director / deputy director of the section / division may cancel an employee's compressed work schedule at any time to accommodate the needs of their section. Additional provisions apply, as follows:

- Probationary employees and employees with disciplinary actions or unsatisfactory performance issues are not eligible;
- Eligibility may be seasonal;
- Agency needs will be accomplished by cross-training of participating and non-participating employees.

The Compressed Work option allows employees to vary the length of the workday and length of the workweek.



Administrative and Operational Manual

September 12, 2022

Employees are assigned to work the hourly equivalent of a complete workweek in less than five (5) full days or a complete pay period in less than ten (10) days. For example, an employee who is scheduled to work seventy-five (75) hours over ten (10) days in a two (2) week pay period may compress the work schedule into nine (9) days. Listed below are examples of Compressed Work Week Schedules:

**Schedule A**

Week	Mon	Tue	Wed	Thr	Fri	Total
1	8	8	8	8	8	40
2	Off	9	9	9	8	35

**Schedule B**

Week	Mon	Tue	Wed	Thr	Fri	Total
1	9	9	9	8	Off	35
2	8	8	8	8	8	40

**Schedule C**

Week	Mon	Tue	Wed	Thr	Fri	Total
1	8.5	8.5	8.5	8	4	37.5
2	8.5	8.5	8.5	8	4	37.5

These schedules can be arranged so that different employees have a day off on Monday of week 1, Friday of week 1, Monday of week 2, or Friday of week 2, to provide adequate staff on every day, and a Monday or Friday off every other week for each employee. Employees may work with their supervisor to determine an alternate schedule to those listed above, such as scheduling a mid-week day off or designing a schedule for a 40-hour per week shift worker, so long as they have received approval from their commander / director / deputy director and there is adequate and appropriate coverage in their section.

Supervisors have the authority to adjust an employee's flex schedule based on workload issues, such as time-sensitive assignments, to assure goals and deadlines are met.

Days off cannot be accumulated. The earned day off must be taken within the pay period. Employees are required to work the same number of hours required in a regular schedule (excluding overtime or compensatory time earned) or to otherwise account for hours by the use of leave. For example, an employee who takes leave on one of their nine-hour days will be charged nine hours of leave.

When a scheduled day off falls on a day the Agency is closed due to a holiday, the following will apply:

- If a holiday falls on a Friday, the employee's day off will be the day preceding the holiday.
- If a holiday falls on a Monday, the employee's day off will be the day after the holiday.

Supervisors and employees may mutually agree upon a different scheduled day off within the work week.

The Fair Labor Standards Act (FLSA) does not restrict the number of hours an employee can work each day.

**Administrative and Operational Manual****September 12, 2022**

However, hours worked in a non-exempt position in excess of forty (40) hours in a work week must be compensated at a premium rate of time and one half (1.5) times the employee's regular rate of pay, or may be compensated by the accrual of compensatory leave at a time and one half (1.5) rate. Therefore, Compressed Work Week Schedules should not schedule a non-exempt position to work more than 40 hours in a several day workweek.

Employees will be required to complete a Compressed Work Schedule Request Form #994 prior to beginning a Compressed Work Week Schedule and receive approval from their commander / director / deputy director. Human Resources will maintain a file of all approved Compressed Work Week Schedules.

The Sheriff reserves the right to end or suspend the compressed work schedule at any time to meet the needs of the Agency.

**3-605.5 NOTIFICATION OF CHANGE IN SCHEDULE**

Any Patrol Operations officer who receives less than ten (10) days' notice of an involuntary change in work schedule will be entitled to one and one-half (1½) times the regular hourly rate for the first eight (8) hours of work following the change in schedule. This provision applies only to officers assigned to Patrol Operations.

Any Corrections officer who receives less than ten (10) days' notice of an involuntary change in work schedule will be compensated at a rate of one and one-half times their regular hourly rate of pay for all time worked during the Officer's first shift of the new schedule.

These provisions do not apply to:

- any trainee assigned to the field training program or a trainee whose change in schedule results from his matriculating to full status;
- an officer who initiates or requests a change in schedule;
- a change in schedule resulting from a disciplinary action;
- a change in schedule resulting from a promotion;
- when a change in schedule results from an emergency declared by the Governor, Charles County Commissioners, or Office of the Sheriff;
- an officer who volunteers for a change in shift;
- overlap shift days;
- officers who are required to attend training that is facilitated by an outside source or agency where the Sheriff's Office has limited control over the training dates. However, in the event the Sheriff's Office has had fourteen (14) calendar days' notice of the specific training dates and failed to adjust the officer's schedule, the overtime rate shall apply; or
- officers who have been provided with multiple optional training dates and have had the opportunity to sign up and attend said training but through the choice of the officer, has failed to do so.

On any overlap shift days, dayshift and evening shifts may be changed without additional compensation where the officer has been provided with seventy-two (72) hours' notice of the shift change.

On any overlap shift days, midnight shift may be adjusted requiring the officers to report for duty three (3) hours earlier than their regular shift. There shall be no additional compensation for this shift adjustment provided the officers have been provided with seventy-two (72) hours' notice of the shift change.





Administrative and Operational Manual

September 12, 2022

If at any time the current master shift plan for Patrol Operations changes; i.e., reverts to an eight-and- one-half (8½) hour shift, both parties to this Memorandum of Understanding (MOU) agree that within fifteen (15) calendar days, they shall meet to renegotiate the provisions of the corresponding section in the MOU.

If a change is made to the Corrections Division master shift plan, the Sheriff's Office must notify the CCCOA and its members as soon as practicable, but no less than ninety (90) days from the new schedule's implementation.

When the schedule of an officer in Patrol Operations is altered to have them work a full shift on a day which is contiguous to neither the first nor the last day of their regularly scheduled days off, the officer will be paid at the rate of 1.5 times their current salary unless the officer is given at least six (6) months' notice (per MOU).

### 3-605.6 PATROL OPERATIONS – MINIMUM HOURS OFF BETWEEN SHIFTS

Any Patrol Operations officer who is assigned to work another shift with eight (8) hours or less having elapsed between shifts will be entitled to one and one-half (1½) times the regular hourly rate for the eight (8) hours of work on the second shift. This provision applies only to officers assigned to Patrol Operations. This provision shall not apply to:

- a trainee whose change in schedule results from his matriculating to full status;
- an officer who initiates or requests a change in schedule;
- a change in schedule resulting from a disciplinary action;
- a change in schedule resulting from a promotion; or
- when a change in schedule results from an emergency declared by the Governor, Charles County Commissioners, or Office of the Sheriff.

### 3-605.7 MEAL PERIODS

Critical employees are compensated for their meal periods and will take them at a time during their workday which allows for the least interruption.

Non-critical and operational employees will be assigned a designated meal period of either thirty (30) minutes or one (1) hour. The length of the meal period will be determined by the respective division commander / director, and the employee will not be compensated for this period.

Part-time employees may or may not have a designated meal period, dependent upon hours scheduled per day. The decision will be made by the respective division commander / director.

### 3-605.8 ANNIVERSARY MERIT/ STEP PAY INCREASES

All employees will be eligible for a merit/step pay increase upon the anniversary of their date of hire, within their current segment, except in the following circumstances.

- An employee will be denied a salary step/merit increase if the employee has received two or more rating factors which have been deemed below acceptable standards on the employee's most recent performance evaluation or special evaluation.
- An employee will be denied a salary step/merit increase if they are on Special Evaluation at the time their increase is due.

Sworn police officers receive step increases based on negotiations with the Charles County Commissioners

**Administrative and Operational Manual****September 12, 2022**

during the collective bargaining process. The anniversary merit/step pay increase for each individual officer is based on the current Maryland State Police pay scale, rank and prior steps earned.

Correctional officers and civilian employees receive merit increases based on the current, approved CCSO pay scales.

If an employee does not receive a merit/step increase due to an unsatisfactory performance evaluation rating, the employee will not be eligible until the posting of the next rating. If that rating meets or exceeds the required rating, the employee will be eligible for a merit/step increase effective the first pay period after the posting of the official performance rating. Merit/step increases will not be retroactive. See AOM 3-650 for more information regarding the performance evaluation system and use of performance evaluation results.

All anniversary merit/step raises are dependent upon funds having been made available in the then current budget. If merit/step raises have not been approved in the budget, employees will not receive them.

### **3-606 SPECIAL PAY CATEGORIES**

#### **3-606.1 K-9 OFFICER COMPENSATION**

K-9 officers shall be entitled to receive, in addition to any other pay to which they are entitled, \$1600 per dog annually. These payments are to compensate K-9 officers for off-duty care of their assigned K-9's.

The compensation will be paid, in arrears, in quarterly payments of \$400.00. Payments will be made in the same manner and at the same time as the uniform maintenance allotment (January, April, July, and October).

K-9 Officers should also submit requests for overtime for any significant time caring for the dog(s).

##### **3-606.1.1 K-9 ADOPTION VETERINARY EXPENSE REIMBURSEMENT**

In accordance with Maryland Public Safety Article 3-526, Agency employees who assume care and custody of their K-9 after the animal's service with the Agency has ended are entitled to reimbursement for up to \$2,500 of veterinary expenses per calendar year, not to exceed \$10,000 over the life of the K-9.

These funds shall be used for any reasonable and necessary veterinary treatment provided to the dog. Reimbursement may only be used for usual and customary veterinary treatment that is not attributable to abuse or neglect.

To obtain reimbursement, the employee/ adopter must submit a K-9 Adoption Agreement Form #131 through their chain of command to the Sheriff for approval to adopt the K-9. Once approved, the original request form will be kept on file within the Accounting Section until the \$10,000 maximum is reached or the K-9 is no longer living. Copies will be provided to the employee /adopter and placed in their personnel file. The Accounting Section will retain copies of all veterinary treatment bills and medical treatment details.

Once the maximum reimbursement amount is reached or the K-9 dies, the Accounting Section will send the employee/ adopter a notification that the maximum reimbursement amount has been reached. The original request form and all related documents will be transferred from the Accounting Section to the employee's personnel file.

Reimbursement will not be provided until veterinary treatment is verified by written receipt provided to the Agency Accounting Section.

#### **3-606.2 FIELD TRAINING OFFICER (FTO) COMPENSATION**



Administrative and Operational Manual

September 12, 2022

All sworn police and sworn correctional FTOs, the rank of Corporal and below, and sworn court security FTOs, shall be entitled to receive, in addition to any other pay to which they are entitled, three dollars (\$3.00) for each hour they directly instruct and supervise a probationary officer during his initial field-training period. In order to qualify, the sworn police, sworn corrections and sworn court security FTO must have been formally trained and designated an FTO and assigned a probationary officer within the guidelines of the Agency FTO Program. No FTO will receive this additional FTO pay after an assigned probationary officer is released to perform independent duties.

Central Processing Specialists (CPS's) and Communications Training Officers (CTO's, i.e., Station Clerks and PCO's) shall be entitled to receive, in addition to any other pay to which they are entitled, two dollars (\$2.00) for each hour they directly instruct and supervise a probationary Station Clerk, PCO, or CPS during the initial field training period. Only one employee shall receive this benefit per trainee per hour.

An appropriate notation will be made on the time record.

3-606.3 SHIFT DIFFERENTIAL

Shift differential will be paid only for hours actually worked and are not added to sick pay, holiday pay, vacation pay, or any other pay for which work is not actually performed. Shift differential cannot exceed 40 hours in one week for civilian employees, unless working an approved compressed schedule. No shift differential will be paid for hours worked at a rate higher than the employee's normal hourly rate. Employees cannot receive shift differential when receiving overtime pay at the rate of time and a half.

Non-critical and Operational employees are expected to work a seven and one-half (7.5) hour day, seventy-five (75) hours per pay period. The first forty (40) hours worked in one week may be eligible for shift differential if those hours fall during a qualifying shift. These employees shall be eligible for overtime pay for all hours worked over forty (40) in one week.

Critical civilian employees are expected to work, at minimum, eighty (80) hours per pay period. No more than forty (40) hours per work week may be scheduled without compensation of the employee at time and one-half the employee's hourly rate for all hours worked over forty (40) in a seven (7) day period. These employees shall be eligible for overtime pay or compensatory leave for all hours worked over forty (40) hours.

PCO's, Station Clerks, and Central Processing Specialists (CPS's) will be entitled to shift differential for each hour physically worked on evening and midnight shifts as described below, as long as it does not qualify as overtime. Day shift coverage, even if it falls into the below listed times, does not qualify for shift differential.

The shift differential pay is as follows for PCO's and Station Clerks:

Those working the 1800-0600 shift \$3.00 per hour

The shift differential pay is as follows for CPS's:

Shifts beginning 1400 to 1759 hours \$2.00 per hour
Shifts beginning 1800 to 0200 hours \$2.50 per hour
Permanent Midnight shifts \$3.00 per hour

All other civilian employees who work regularly scheduled hours that begin between the hours of 1300-0300 will be entitled to shift differential pay of one dollar (\$1.00) per hour for each hour actually worked. Civilian employees who work a continuation of a day shift beyond their normally scheduled hours, do not qualify for shift differential.

Sworn Police Officers will be entitled to shift differential pay as listed below, per their MOU:

Shifts beginning 1400 to 2059 hours \$2.00 per hour
Shifts beginning 2100 to 0200 hours \$3.00 per hour



## Administrative and Operational Manual

September 12, 2022

Correctional Officers will be entitled to shift differential pay as listed below, per their MOU:

Those working the 1500-2300 shift	\$2.00 per hour
Those working the 2300-0700 shift	\$3.00 per hour

No shift differential will be paid for hours worked at a rate higher than the officer's normal hourly rate. An officer will not be paid shift differential for overtime hours.

### 3-606.4 ACTING PAY

When an employee assumes the duties of a rank or position greater than their own, subject to the conditions hereafter listed, any such employee shall be entitled to receive acting pay as described herein (per MOU):

- Employees shall receive acting pay when it is anticipated that the employee will be, or the employee has been, in the acting role for a period of thirty calendar days or more.
- The employee will receive acting pay upon taking over the acting position when the acting appointment was requested and granted at least 30 days prior to taking over the assignment.
- If the appointment is made less than 30 days prior to taking over the assignment, the employee will receive acting pay as soon as the appropriate change in payroll status can be accomplished.
- An employee who has performed in a rank or position greater than his own for thirty (30) consecutive days, without already receiving acting pay, will then be entitled to retroactive pay for the thirty (30) days.
- No employee shall receive acting pay for a period when, after qualifying for acting pay, that person is absent from the position for any reason for a period of more than one week, and in no case will more than one person qualify for acting pay in the same position for the same period of time.
- When a person has qualified for acting pay, that person shall be paid acting pay until such time the person is relieved of the position by the Sheriff or other supervisory authority.

A sworn employee qualifying for acting pay will be paid at the pay rate of the assumed rank scale equivalent to his years of service. A non-sworn employee receiving acting pay will have their rate of pay temporarily adjusted to provide them with an increase of six percent (6%), or the minimum of the acting grade, provided the resulting salary does not exceed the maximum of the higher grade.

Any other pay considerations which may apply to the higher position shall apply to the employee assuming the position during the acting period. For example, a person acting in a position which is exempt from overtime pay would not be paid overtime, and, if a person were in a position qualifying for overtime, the overtime rate would be based upon the acting pay rate.

### 3-606.5 AVAILABILITY OF ACTING PAY FOR A PARTICULAR POSITION

Before a commander/ director may install an employee in an acting position, written approval must be obtained from the Sheriff or an Assistant Sheriff. The commander/ director shall direct a memorandum to the Sheriff, through the Assistant Sheriff, stating the following information concerning the acting pay:

- explain why the position is vacant;
- justify filling the position;
- provide the anticipated effective dates for the acting position;
- identify the person to be placed in the acting status; and
- justify the selection of the person to be placed in an acting status.



Administrative and Operational Manual

September 12, 2022

### 3-606.6 FOREIGN LANGUAGE PROFICIENCY PAY

Once per year during the month of January, the Human Resources Section will make an Agency-wide announcement regarding the availability of language proficiency pay for qualified officers and civilians.

Any sworn / correctional officer or civilian employee who maintains proficiency in one or more of any foreign languages, or in American Sign Language, will be entitled to language proficiency pay. The compensation will be paid, in arrears, in quarterly payments of five-hundred dollars (\$500). Payments will be made in the same manner and at the same time as the uniform maintenance allotment (January, April, July, and October).

- To apply for the specialty pay, eligible employees shall submit a Request for Language Proficiency Pay Form #938 to the Human Resources Section.
- In order to be considered proficient and entitled to receive Language Proficiency Pay in a foreign language, an employee must receive a grade level of Intermediate Mid or higher as determined by the American Council on the Teaching of Foreign Languages (ACTFL), after being tested.
- In order to be considered proficient and entitled to receive Language Proficiency Pay for American Sign Language, an employee must receive a grade level of advanced or superior as determined by the American Sign Language Proficiency (ASLP) test.
- In order to remain qualified, employees will be retested every three years. The Agency will bear the cost, if any, of the testing.

Once an eligible employee is determined to be proficient in a foreign language or in American Sign Language, Human Resources will certify to Deputy Director, Budgeting Section the entitlement to the quarterly payment. Deputy Director, Budgeting Section will process the request and ensure payment is made.

A list of all sworn/ correctional officers and civilian employees proficient in a foreign language or in American Sign Language shall be compiled by Human Resources and provided to the Communications Section and the Detention Center.

Communications must be contacted any time interpretation services are needed to ensure only employees who have been tested and found to be proficient are being utilized.

### 3-606.7 TITLE COMPENSATION

Those Corporals and Sergeants who are appointed the title of Master Corporal or Master Sergeant may be eligible for additional compensation known as Title Compensation. This compensation is not considered base pay, but falls under the special pay category the same as education or foreign language pay.

This compensation will be paid annually in December to those officers receiving a Master title appointment before November 1 of that fiscal year, as follows:

- Master Corporal           \$500
- Master Sergeant         \$750

### 3-607 OVERTIME COMPENSATION

It is policy of the Charles County Sheriff's Office to comply with the Federal Fair Labor Standards Act. Non-exempt, sworn police officers, correctional officers and civilians will receive compensation for hours worked in excess of scheduled duty hours. Employees may be required to work overtime hours as necessitated by work related



## Administrative and Operational Manual

September 12, 2022

conditions. If at all possible, reasonable notice of overtime requirements will be provided to the employee. In unforeseen emergency situations, employees may be required to work overtime with little or no notice.

Hours which have not been designated as emergency work, and are worked by employees staffing non-exempt positions up to forty (40) hours in a seven (7) day work week will be compensated at a regular rate of one (1) time the employee's regular rate of pay, or may be compensated by the accrual of compensatory leave at an hour-for-hour accrual rate. Overtime worked by employees staffing non-exempt positions in excess of forty (40) hours in a seven (7) day work week must be compensated at a premium rate of one and one-half times the employee's regular rate of pay, or may be compensated by the accrual of compensatory leave at a one and one-half rate.

At least fifteen (15) minutes must be worked past the end of the employee's shift in order to be eligible for overtime. Overtime may then be acquired in one-half (1/2) hour increments (15 to 44 minutes worked = 1/2 hour claimed, 45 to 74 minutes worked = 1 hour claimed, 75 to 104 minutes worked = 1 1/2 hours claimed, etc.). These hours will be paid at one and one-half (1 1/2) times their normal hourly rate.

Exempt employees are not entitled to overtime compensation. The civilian Deputy Director of the Forensic Science Section and civilian employees in exempt positions grades 119 or below may, with the permission of the Division Commander / Director, be eligible to receive additional pay or accrue compensatory leave at an hour-for-hour (straight time) rate for hours worked in excess of 37.5 / 40 hours. Division commanders must first attempt to adjust the employee's schedule before authorizing additional compensation. In time of emergency, the Sheriff or his designee may authorize paid administrative leave when appropriate. Exempt employees will not receive compensation for accrued compensatory leave at the time of separation or retirement.

Non-exempt civilian critical / operational employees will receive overtime compensation at one and one-half (1 1/2) times the regular hourly rate for all hours worked in excess 40 hours per week.

For non-exempt, non-critical / operational employees, the first two and one-half (2 1/2) hours of overtime worked by those employees who are on a thirty-seven and one-half (37 1/2) hour work week will be paid at their normal hourly rate.

Compensatory leave is the preferred method of compensation for non-exempt, non-critical employees for hours worked over regularly scheduled hours. Any compensatory time earned while a non-exempt employee will be paid out at the time of separation of employment, upon transfer/promotion to an exempt position or upon position reclassification from non-exempt to exempt.

When an employee is required to work an extra hour to cover a shift because of a daylight savings time change, the employee will be entitled to one (1) hour overtime compensation. Employees whose shift is shortened because of a time change will be required to work the full shift hours (one hour beyond their scheduled time off) or use one (1) hour of accrued leave.

Employees will submit and document overtime on their timesheets as required.

### 3-607.1 COURT TIME

An employee summoned or requested to appear in a court or other judicial proceeding during non-duty hours will receive overtime compensation if the summons or request is a result of the employee's official duties and the employee does in fact attend as required. The employee will receive overtime compensation in one-half (1/2) hour increments for their time in attendance.

#### **Sworn Correctional Officers – Court Appearance Minimum**

Any sworn correctional officer who appears in court during his non-duty hours as a result of the employee's official duties shall be entitled to a minimum of three (3) hours of overtime pay at a rate of one and one half (1 1/2) times their regular rate of pay. Appearing in court means dressed in accordance with policy and prepared to testify, including obtaining and reviewing all relevant reports and evidence. An officer who appears in court unprepared or not dressed appropriately shall forfeit all pay for that court appearance.

**Administrative and Operational Manual****September 12, 2022****Sworn Police Officers – Court Appearance Minimum**

Sworn police officers attending court during non-duty hours on matters arising from their employment with the Charles County Sheriff's Office will be paid the Court Appearance Minimum when the court appearance is before 1600 hours.

If the employee is released by the Court or State's Attorney before he has remained in attendance for two (2) hours, the employee will still be entitled to two (2) hours of overtime pay as a minimum for that response unless part of that two (2) hours is part of his normal work schedule. If a second court appearance / docket begins within the specified minimum timeframe (2 hours) of the first appearance, that appearance is considered a continuation of the first appearance and the court minimum will apply to the two appearances combined, not individually. This applies in the same manner and amount for appearances in District or Circuit Court and appearances before the Liquor Board or any other administrative court.

**Sworn Police Officers – Court Overtime Following an Evening or Midnight Shift**

Sworn police officers who attend a court appearance scheduled to begin before 1200 and after working a shift ending between 0100 and 0700 will be entitled to a minimum of three (3) hours of overtime pay at one and one-half (1½) times the regular hourly rate. If an officer has more than one (1) court appearance (double docket) on that same day, the three (3) hour minimum applies to both court appearances with the following exceptions. If the second court appearance/docket begins within the specified minimum timeframe (3 hours) of the first appearance, that appearance is considered a continuation of the first appearance and the three (3) hour minimum will apply to the two appearances combined, not individually. The three (3) hour minimum does not apply if the first appearance is after 1200 hours. In such case the officer will be entitled to the Court Appearance Minimum.

**3-607.2 ON-CALL / CALL BACK COMPENSATION**

Employees who are assigned to be on-call are not confined to their homes, but they must be reachable by phone and must be able to respond to an urgent or emergency situation in a timely manner.

When an officer is called back to work with less than seventy-two (72) hours' notice during scheduled time off, the officer will receive overtime compensation in one-half (½) hour increments for those hours the officer is required to work outside his normal work schedule. For any call back, unless seventy-two (72) hours' notice is given, the officer shall receive a minimum of four (4) hours overtime compensation unless the four (4) hours is part of the officer's normal work schedule. In that case, the officer would receive the portion of the four (4) hours that is outside his normal work schedule.

- For the purposes of determining the number of hours worked as a result of a call out, the clock will begin to run as of the time the officer goes en route from his home to the place the officer has been called to work.
- This provision does not apply to an officer who is called in or called back to appear in any court.
- This provision does not apply in instances where an officer is called back to work due to the officer's neglect to complete an assignment (i.e., failed to sign a report, failed to turn in a report, failed to turn in equipment, etc.).

Members of the Emergency Services Team will receive compensation as specified above. Additionally, members of the Emergency Services Team will receive two (2) hours minimum call out compensation when more than seventy-two hours (72) notice is given, provided that the Emergency Services Team actually responds to the incident or activity. However, in such situations where the scheduled assignment is canceled and more than seventy-two (72) hours' notice is provided, no additional compensation will be paid.

When a sworn employee assigned to the Criminal Investigations Division is assigned in a stand-by capacity between the times of Saturday 2300 through Monday 0700 hours, and is not called out for an incident, the employee shall receive nine (9) hours of Administrative Leave. The Administrative Leave shall be separate from any and all leave



## Administrative and Operational Manual

September 12, 2022

banks and will be managed by the Division. The Division Commander shall establish a procedure for tracking the accrual and use of this leave. The Administrative Leave is non-transferable, does not carry-over when the officer is re-assigned to another division, and has no cash value. The provisions of this section do not apply to the officers assigned to the Narcotics / Vice section.

When a non-sworn, non-exempt employee is called back to work during scheduled time off, the employee will receive overtime compensation in one-half (1/2) hour increments for the time the employee is required to perform work outside his normal work schedule. For any call back for which the employee responds to a work location, he shall receive a minimum of two (2) hours overtime compensation, except if the time worked is part of the employee's normal work schedule. In that case, the employee would receive the portion of the two hours which is outside his normal work schedule. For the purposes of determining the number of hours worked as a result of a call out, the clock will begin to run as of the time the employee goes en route from his home to the place the employee has been called to work.

### 3-607.3 OVERTIME APPROVAL

Conditions which change unexpectedly and give rise to the need to have employees work overtime are a routine occurrence in police work. When these occasions occur, division commanders / directors and section commanders or their designees are granted the authority to approve the overtime necessary to meet the situation.

All overtime which is not incurred because of unforeseen circumstances will be approved by the division commander / director. Supervisors who anticipate the need to require an employee to work overtime will submit a memorandum or otherwise contact the division commander / director. The supervisor will address the condition(s) that require the use of overtime, the expected period of time the condition will last, the personnel expected to work the overtime and the number of hours each is expected to work. If there are levels of supervision between the requesting supervisor and the division commander / director, the memorandum or discussion will be directed through the chain of command with concurrence / non-concurrence by each person in that chain of command.

## 3-608 LEAVE

The Sheriff recognizes the need to provide employees with time away from their duties so they might attend to personal and family needs, recuperate from sickness or injuries, relax and renew their energies, and fulfill their obligations in matters apart from the workplace.

### 3-608.1 DEFINITIONS

The following terms have the defined meanings for purposes of this Manual Section:

**Child** - Child includes the biological children of the employee, the biological children of the employee's current legal spouse, legally adopted children of the employee and/or current legal spouse, foster child, stepchild, legal ward, or other child for whom the employee stands in loco parentis regardless of the child's age. To stand in loco parentis means to have assumed the duties of a parent to a child.

**Extended Leave** - As used in this policy is defined as sick and safe leave for any period of time greater than three (3) continuing work days, regardless of regular days off; other types of leave continuing for a period of ten (10) work days or more, regardless of regular days off.

**Immediate Family** - Includes the employee's spouse, child or stepchild, parent, sister or brother, half-sister or half-brother, stepsister or stepbrother, grandchild, grandparent, great-grandparent, father or mother-in-law, son- or daughter-in-law, and sister- or brother-in-law.

**Liberal Leave** - The declaration of a liberal leave status within the Sheriff's Office is established by the Sheriff when the Charles County Commissioners decide that such a status is required for Charles County employees; however,





## Administrative and Operational Manual

September 12, 2022

the Sheriff may declare liberal leave status for Sheriff's Office employees in the absence of a liberal leave declaration by the Charles County Commissioners. During this period of liberal leave, non-critical employees of the Sheriff's Office may elect to stay at home or leave work during their assigned work hours. These employees must inform their supervisors of their intentions to use leave instead of coming to work; however, no previous leave approval is necessary. All critical and operational employees must report to work at the beginning of their assigned work shifts during periods of liberal leave.

**Parent** - Parent includes the biological mother or father of the employee and/or a person who legally adopted and raised the employee.

**Spouse** - Spouse is the person to whom the employee is currently legally married.

### 3-608.2 ANNUAL LEAVE

Full-time non-critical and operational civilian employees of the Sheriff's Office will earn annual leave at the following rates:

- first 36 months of employment - 8 hours per month;
- on the anniversary of 3 yrs. service - 10 hours per month;
- on the anniversary of 9 yrs. service - 12 hours per month;
- on the anniversary of 14 yrs. service - 14 hours per month;
- on the anniversary of 21 yrs. service - 18 hours per month.

Full-time reduced hours employees will earn annual leave at the following rates:

- first 36 months of employment – 6 hours per month;
- on the anniversary of 3 yrs. service - 8 hours per month;
- on the anniversary of 9 yrs. service - 10 hours per month;
- on the anniversary of 14 yrs. service - 11 hours per month;
- on the anniversary of 21 yrs. service - 14 hours per month.

Additionally, sworn and correctional officers and critical civilians will earn annual leave at the following rates:

- first 36 months of employment - 8 hours per month;
- on the anniversary of 3 yrs. service - 10 hours per month;
- on the anniversary of 8 yrs. service – 12 hours per month;
- on the anniversary of 12 yrs. service – 14 hours per month;
- on the anniversary of 18 yrs. service – 16 hours per month;
- on the anniversary of 21 yrs. service – 18 hours per month.

Leave is earned daily per working day. When an employee begins work during a month, or leaves employment during a month, leave is pro-rated. This is accomplished by dividing the amount of leave normally earned by the employee in a month by the number of work days in the month when employment is begun or terminated. The result is then multiplied by the number of work days completed within the month. Leave is not credited to the employee's leave account until the end of the month in which it is earned.

Critical employees may accumulate a maximum of 720 hours of annual leave.

Non-critical and operational employees may accumulate a maximum of 360 hours of annual leave. A critical employee, who becomes non-critical or operational because of reclassification of his position or because of a change of position, will have one year from the effective date of the change or reclassification to comply with the 360-hour maximum.

For critical, operational, and non-critical employees, annual leave over the maximum allowed amount will be

**Administrative and Operational Manual****September 12, 2022**

converted to sick and safe leave. This conversion will take place at the end of the calendar year in which the maximum annual leave amount is exceeded or at the time of separation or retirement. No leave converted in this manner may be thereafter recovered as annual leave.

Annual leave must be requested and approved in advance by the employee's supervisor and will be used in even increments of one-half (1/2) hour. No leave may be used before it is earned and credited to the employee's leave account.

Annual leave requests for three (3) or less days off should be submitted to the employee's supervisor as soon as the expected use is known. Annual leave requests for more than three (3) days should be submitted at least fourteen (14) days before the first requested day off. All annual leave requests for more than ten (10) days must be approved by the employee's division commander / director or his designee.

An employee who resigns, retires, is dismissed, or otherwise leaves employment with the Sheriff's Office is entitled to receive a lump sum payment for the employee's annual leave balance. This payment will be made on the employee's next pay date following his final regular paycheck and only after the Deputy Director, Accounting Section has received notification of clearance from Human Resources. The employee must provide written, notarized authorization for deductions of any amounts owed the Sheriff's Office.

**3-608.3 OFFICERS ON APPROVED EXTENDED LEAVE**

Exempting approved annual, compensatory, holiday, or military leave, officers on all other forms of extended leave are prohibited from working law enforcement / security-related secondary employment. Officers on military and all other forms of extended leave will be required to make arrangements to park their assigned vehicle at their designated work location or the Annex until such time they return to work.

**3-609 SICK AND SAFE LEAVE**

Sick and safe leave, previously known as sick leave, is provided to all employees who work at least 12 hours a week.

**3-609.1 DEFINITIONS**

The following term(s) have the defined meanings for purposes of this manual section and in accordance with the Maryland Healthy Working Families Act.

**"Family Member" refers to:**

- a biological child, an adopted child, a foster child, or a stepchild of the employee;
  - a child for whom the employee has legal or physical custody or guardianship;
  - a child for whom the employee stands in loco parentis, regardless of the child's age;
  - a biological parent, an adoptive parent, a foster parent, or a stepparent of the employee or of the employee's spouse;
  - the legal guardian or ward of the employee or of the employee's spouse;
  - an individual who acted as a parent or stood in loco parentis to the employee or the employee's spouse when the employee or the employee's spouse was a minor;
  - the spouse of the employee;
  - a biological grandparent, an adopted grandparent, a foster grandparent, or a stepgrandparent of the employee;
  - a biological grandchild, an adopted grandchild, a foster grandchild, or a stepgrandchild of the employee;
- or



Administrative and Operational Manual

September 12, 2022

- a biological sibling, an adopted sibling, a foster sibling, or a stepsibling of the employee.

### 3-609.2 SICK AND SAFE LEAVE ACCRUAL RATES AND USAGE

All full-time employees shall earn sick and safe leave at the rate of ten (10) hours per month. Full-time reduced hours employees earn sick and safe leave at the rate of eight (8) hours per month. Part-time employees will earn sick and safe leave at the rate of 2.5 hours per pay period.

All part-time crossing guard employees will earn sick and safe leave at the rate of 2.5 hours per pay period with the exception of their non-worked summer pay periods.

Charges against an employee's sick and safe leave account shall be in increments of one-half (1/2) hour for periods that the employee is absent on approved sick and safe leave. An employee who has exhausted his sick and safe leave account will be charged accrued leave from any of his other leave accounts (annual, compensatory, or holiday). Part-time employees who have exhausted all sick and safe leave will be placed in a leave without pay status. There shall be no advancement of sick and safe leave, except as noted elsewhere in this policy.

There is no limit on the amount of sick and safe leave employees may accumulate. Unused sick and safe leave in any year will be automatically carried forward to the next year and remain in the employee's sick and safe leave account until used by the employee or until the employee leaves employment with the Sheriff's Office. Sick and safe leave is intended only to apply to current employment and has no residual monetary value. When an employee leaves a position with the Sheriff's Office, there will not be a payment for unused sick and safe leave. However, all full-time and full-time reduced hour employees may receive a retirement benefit for unused sick and safe leave as outlined in the respective retirement program.

Part-time employees, to include crossing guards, may use up to seventy-two (72) hours of sick and safe leave per calendar year. Requests to use more than seventy-two (72) hours of leave shall be submitted to the Sheriff for approval.

### 3-609.3 NEW EMPLOYEE SICK AND SAFE LEAVE ADVANCE

All full-time and full-time reduced hours employees hired by the Charles County Sheriff's Office are advanced eighty (80) hours of sick and safe leave when they begin employment.

All part-time employees are advanced fifty (50) hours of sick and safe leave when they begin employment.

Employees will begin earning sick and safe leave after their normal accrual rate reaches eighty (80) hours:

- Full-time employees after eight (8) months;
- Full-time reduced hours employees after ten (10) months.

Part-time employees will begin earning sick and safe leave after their normal accrual rate reaches fifty (50) hours.

Employees shall not earn sick and safe leave during the advanced sick and safe leave period.

Part-time employees transferring to a full-time or full-time reduced hours position will have their existing paid sick and safe leave transferred to the new position. They will begin to accrue sick and safe leave at the rate for the new position immediately, and therefore will not be advanced eighty (80) hours of sick and safe leave.

An employee who is rehired within a year of separation from the Agency will have all unused sick and safe leave reinstated if it was not rolled into their retirement.

The advanced sick and safe leave shall be used in accordance with Agency sick and safe leave policy.



Administrative and Operational Manual

September 12, 2022

### 3-609.4 SICK AND SAFE LEAVE QUALIFYING EVENTS

Sick and safe leave is approved for use for the following qualifying events in accordance with the Maryland Healthy Working Families Act:

- in accordance with the provisions of the Family and Medical Leave Act of 1993 (see FMLA section of policy).
- to care for or treat the employee's mental or physical illness, injury or condition and to allow the employee to rest and recover from illness or temporary disability that prevents the employee from performing the essential functions of the employee's job;
- to obtain preventative medical care for the employee or employee's family member, including to allow the employee to keep necessary medical or dental appointments;
- to care for a family member with a mental or physical illness, injury, or condition, including taking the family member to necessary medical or dental appointments;
- for maternity or paternity leave; or
- if the absence from work is necessary due to domestic violence, sexual assault, or stalking committed against the employee or the employee's family member:
  - and the leave is being used to obtain medical or mental health attention, services from a victim services organization, or legal services; or
  - during the time the employee has temporarily relocated due to the domestic violence, sexual assault, or stalking.

### 3-609.5 SICK AND SAFE LEAVE NOTIFICATION AND APPROVAL

Procedures for sick and safe leave notifications and approvals are to be established in each division's Standard Operating Procedures. At a minimum, the procedures should include:

- the minimum amount of time ahead of the employee's scheduled start time when the employee must make notification (30 minutes, 1 hour, etc.);
- designation of the person / location where notification is to be made;
- a requirement that the employee making notification record the date, time, and identification of the person notified;
- a requirement that the employee receiving notification record the information and notify the employee's supervisor or another supervisor on duty of the request prior to the employee's scheduled start time.

For all scheduled medical and dental appointments, employees shall request sick and safe leave in advance through the TimeClock Plus system.

### 3-609.6 SICK AND SAFE LEAVE ABUSE

If there is reason to believe the sick and safe leave privilege has been abused, a commander / director acting on behalf of the Sheriff may request a medical certificate to justify any period of absence. In such cases, the employee

**Administrative and Operational Manual****September 12, 2022**

will be advised in advance that documentation will be required to support any further granting of sick and safe leave, regardless of duration.

If the leave is requested for medical purposes, this certificate will be in the form of official documentation from the treating physician's office and shall describe the nature of the illness / injury, date the treatment began, and date of discharge from treatment. Provided the name of the physician or medical facility is pre-printed or stamped, and the physician's signature appears thereon, any of the following will be deemed acceptable sources:

- prescription pad;
- desk or note pad; or
- office stationery.

If leave is requested for services or legal proceedings related to or resulting from domestic violence, sexual assault, or stalking, the certificate will be in the form of official documentation from the provider of the services or legal proceedings.

Disciplinary action may be taken if there is reason to believe there has been sick and safe leave abuse. In determining the severity of the discipline, the following shall be considered:

- the nature and gravity of the offense;
- the employee's sick and safe leave record;
- the employee's work record; and
- any other factors including, but not limited to, extenuating or mitigating circumstances presented by the employee.

An employee on sick and safe leave or calling in sick is prohibited from working law enforcement / security-related secondary employment. An employee on sick and safe leave must return and work the next regularly scheduled shift before working any law enforcement / security-related secondary employment.

### **3-609.7 MANDATED SICK AND SAFE LEAVE USE**

The employee shall be placed on sick and safe leave / extended sick and safe leave whenever medical opinion confirms the employee's medical condition may seriously impair his ability to perform the essential functions of his position or may jeopardize the health or safety of the employee or any other person. In this regard, a commander / director, in coordination with the Human Resources Section, may order the employee to undergo a fitness for duty medical evaluation.

### **3-609.8 EXTENDED SICK AND SAFE LEAVE**

Extended sick and safe leave refers to the use of sick and safe leave for any period of time greater than three (3) continuing work days, regardless of regular days off.

### **3-609.9 EXTENDED SICK AND SAFE LEAVE – EMPLOYEE'S RESPONSIBILITIES**

Employees who are absent on extended sick and safe leave will notify their supervisors. Employees will also contact Human Resources and provide the Human Resources Administrator with written documentation of the qualifying event, such as documentation from their attending physician / health care provider after each medical appointment. All such documentation shall be submitted directly to the Human Resources Administrator.

If the employee is prescribed medications, the employee will follow the requirements set forth later in this policy.

Sworn police officers who are absent from work on extended sick and safe leave may not wear a police uniform or operate an Agency vehicle for the duration of the extended sick and safe leave period.



**Administrative and Operational Manual**

**September 12, 2022**

**3-609.10 EXTENDED SICK AND SAFE LEAVE – SUPERVISOR’S RESPONSIBILITIES**

If the employee will be absent for no more than three (3) work days, the supervisor need only remind the employee that absences resulting in extended sick and safe leave need to be supported by documentation of the qualifying event.

If the employee is absent more than three (3) working days, the immediate supervisor will complete the Extended Sick and Safe Leave Form #691 and instruct the employee to contact the Human Resources Administrator for further direction. The form will be forwarded to the Human Resources Section.

Any documentation of the qualifying event the supervisor receives from the employee or the employee’s physician shall be forwarded immediately to HR. Under no circumstances should originals or copies of medical documentation be kept anywhere in the Agency other than in the employee’s confidential medical file in HR.

The immediate supervisor will advise the chain of command that the employee is on extended sick and safe leave.

**3-609.11 EXTENDED SICK AND SAFE LEAVE – HUMAN RESOURCES RESPONSIBILITIES**

Upon receipt of the Extended Sick and Safe Leave Form #691, the Human Resources Administrator will make contact with the employee to provide further instruction. Upon receipt of written documentation from the employee’s physician (doctor’s note), HR will review the information provided to determine if the employee should be placed under the provisions of FMLA. In cases of severe injury or illness of a sworn police or correctional officer, HR will provide the information to the employee’s Assistant Sheriff who will determine if the employee should be placed in a non-officer status.

Human Resources will monitor the nature and extent of an employee’s illness or incapacitation, the employee’s progress toward recovery, the likelihood or expected date of the employee’s return to duty, and requests for accommodations. Human Resources will make appropriate recommendations, supported by written documentation and justification and maintain a confidential record of all documentation received from the employee’s physician.

In addition, Human Resources will maintain communication with the employee’s division commander regarding the employee’s status for the duration of the employee’s extended sick and safe leave. The division commander will be responsible for relaying the status to the employee’s immediate supervisor through the chain of command.

**3-609.12 DIVISION COMMANDER RESPONSIBILITIES**

If the employee is, or is expected to be, on extended sick and safe leave for more than 72 hours, Human Resources will notify the Division Commander. Human Resources will advise the Division Commander of the reasons for the leave and of any entitlements to further leave under the Family and Medical Leave Act and/or the Maryland Healthy Working Families Act. If the employee is not entitled to further leave, the Division Commander may approve continued use of accumulated sick and safe leave, allow the employee to use other accumulated leave accounts, or deny further leave.

**3-609.13 SECONDARY EMPLOYMENT WHILE ON SICK AND SAFE LEAVE / EXTENDED SICK AND SAFE LEAVE OR DISABILITY LEAVE**

An employee on sick and safe leave, extended sick and safe leave, or disability / workers’ compensation leave shall not work security-related secondary employment.

**3-609.14 PRESCRIPTION MEDICATIONS**



## Administrative and Operational Manual

September 12, 2022

Any employee prescribed medication who intends to report to work while taking said medication shall inquire whether the drug has any side effects which might interfere with his ability to safely perform the essential functions of his position. If the prescriber advises that the drug could adversely affect the employee's abilities to safely perform his duties as defined in his position description, the employee shall obtain this information in writing from the prescriber and present it to the Human Resources Administrator. The written documentation from the prescriber shall include a list of all prescribed medications and indications as to which ones could affect the employee's ability to perform essential job duties.

If it is determined the prescribed medication will affect the employee's ability to perform essential job duties, the following actions may be taken:

- The employee may be placed in a modified duty assignment, in accordance with AOM 3-611.
- If an appropriate modified duty assignment is not available or if the effects of the prescribed medication prevent the employee from safely accomplishing a modified duty assignment, the employee will be placed on sick and safe leave.
- For sworn police and correctional officers, if the medication is determined to affect the judgmental and motor skills to a level that rational decision making would be impaired, then that officer will be placed in a temporary non-officer status, as authorized by an Assistant Sheriff, and in accordance with AOM 3-611.5.

### 3-609.15 NON-PRESCRIPTION MEDICATIONS

Any employee using legal non-prescription medication who feels unable to safely perform the essential functions of his position and who intends to report to work while taking said medication shall inform his supervisor. If there is no other appropriate duty to which the affected employee can be assigned, the supervisor shall place the employee on sick and safe leave.

### 3-609.16 FELLOW EMPLOYEE'S RESPONSIBILITIES

It is the responsibility of all employees to report to their supervisor, or directly to Human Resources, a fellow employee who appears to be suffering from a mental or physical disability which interferes with the employee's ability to safely perform the essential functions of his job. Human Resources will make the necessary referrals and make appropriate recommendations to the Sheriff regarding correctional leave and the future status of the employee. Human Resources may require the employee to undergo additional examinations to determine suitability for retention in active service.

### 3-609.17 ADVANCED SICK AND SAFE LEAVE

Sick and safe leave may be advanced by the Sheriff under the following conditions:

- All available accumulated forms of paid leave (annual, compensatory, sick and safe, and holiday) must be exhausted;
- The amount of sick and safe leave advanced to the employee's account may not exceed thirty (30) days at any time;
- Where it is known the employee is to be retired, or where it is anticipated the employee is to be separated, the total advance may not exceed an amount which can be liquidated by subsequent accrual prior to the separation;
- There must be a reasonable assurance the employee will return to duty;



Administrative and Operational Manual

September 12, 2022

- A medical certificate attesting to the necessity for the absence must support the request for advanced sick and safe leave;
- All advanced sick and safe leave unearned at the termination of employment shall be reimbursed to the County at the employee's daily rate of pay;
- Only employees eligible to earn sick and safe leave are eligible to receive advanced sick and safe leave; and
- The employee has not been required to provide a medical certificate under the sick and safe leave abuse section.

### **3-610 INJURED IN THE LINE OF DUTY (ILD) LEAVE - SWORN AND CORRECTIONAL OFFICERS**

Officers disabled while in the line of duty receive full salary for the period of temporary disability without charge against leave balances, provided:

- the disability is temporary; and
- the disability resulted from an injury or illness sustained directly in the performance of the officer's duties.

An officer may be placed on Injured in the Line of Duty (ILD) leave when he incurs illness, injury, disability, or a medical condition preventing him from performing the essential duties of his position.

Supervisors shall contact employees on ILD leave for more than seven (7) days at least once a week during the first thirty (30) days to verify the continued disability. This contact shall be documented.

Employees shall assign to the Agency such non-medical benefits as awarded for the temporary disability by the Maryland Workers' Compensation Commission.

#### **3-610.1 ON DUTY INJURY / ILLNESS—DISABILITY / WORKERS' COMPENSATION**

When an employee is injured on the job, a Report of Injury or Illness, Form #227, shall be completed and faxed to Human Resources within twenty-four (24) hours of the injury. The employee, or in the case the injuries prevent such preparation, the supervisor, shall prepare Form #227. Supervisors shall investigate all injuries. The investigation shall be completed on Form #227 before the end of the shift during which the injury occurred. Should additional space be required, a continuation / supplement can be submitted with Form #227. A separate report is not needed. Form #227 and any attachments, to include discharge papers and doctors' notes, will be submitted directly to Human Resources.

The sooner the injury is reported to the Human Resources Section, the sooner the employee is given a medical claim number. This claim number is needed so the employee can schedule follow-up appointments. It also improves billing issues and reduces unexpected problems for the employee.

Only injuries which occur in the course of the employee fulfilling the duties of his employment are reported as workers' compensation injuries.

An employee who misses work due to a reported on-duty injury or illness will be placed on Administrative Leave until the case has been reviewed and accepted or denied by the Agency's insurance company. If the claim is denied, the employee will be required to use his own accrued leave.

In the case of a job-related illness that has occurred over the course of time, the employee is required to report the illness via a Report of Injury or Illness Form #227 within 24 hours of the diagnosis. It is the employee's responsibility to report on-the-job injuries to the Maryland Worker's Compensation Commission as outlined elsewhere in this



**Administrative and Operational Manual****September 12, 2022**

policy.

If any medical treatment was administered because of an injury or job-related illness, a physician's certificate must accompany the report.

Any subsequent reports / documents submitted regarding the same injury shall be submitted directly to the Human Resources Section. Examples of such documents are medical prognosis and fit for duty certification.

The employee is required to attend all follow-up appointments as recommended by a physician and provide copies of supplemental reports to the Human Resources Section as noted above.

The employee must also comply with prescription medication requirements as outlined in AOM 3-609.

### **3-610.2 DENIAL OF ADMINISTRATIVE LEAVE FOR LINE-OF-DUTY INJURY CLAIM**

Administrative leave for Line-of-Duty injuries shall not be granted:

- once the Agency's insurance company has determined the employee's disability is not work related. In such cases the employee shall be required to utilize accrued leave; or
- once a medical prognosis has established that an employee is not disabled. In such cases, the employee may request another form of paid leave.

The Sheriff will consider the request and may grant additional forms of paid leave as he deems appropriate. Once FMLA protection has expired, the Sheriff can order the employee to return to work. If ordered, the employee must return to work. If the employee refuses, the Sheriff may initiate disciplinary action against the employee for being AWOL and refusal to obey a lawful order.

### **3-610.3 ADMINISTRATIVE LEAVE GRANTED FOR LINE-OF-DUTY INJURY CLAIM**

Administrative leave for a Line-of-Duty injury is limited to the period specified in the attending physician's statement. Administrative leave may be granted for up to thirty (30) calendar days based on a single attending physician's statement. An employee on administrative leave shall submit a current medical prognosis to the Human Resources Section at least every thirtieth (30<sup>th</sup>) calendar day. The employee must submit an attending physician's statement to Human Resources to be eligible for additional leave.

Employees may be granted administrative leave in half-day increments for follow-up medical appointments after a return to duty. In order to be eligible, employees must submit a doctor's note for the appointment.

Administrative leave for Line-of-Duty injury shall not exceed 180 calendar days for any one injury or illness. Employees may petition the Sheriff for additional periods of ninety (90) days of administrative leave. The Sheriff shall review the request, along with the attending physician's statement, to decide the appropriateness of continuing leave. Officers may be granted up to two (2) additional 90-day periods of leave for a maximum of one (1) year. Before this point, consideration of a disability or medical retirement will have been explored.

If an employee remains unable to return to duty after using 180 days of administrative leave and is not authorized an extension by the Sheriff, he is placed on sick and safe leave or other forms of paid leave as deemed appropriate by the Sheriff. The employee may request Leave Without Pay (LWOP). LWOP may not exceed one year or extend beyond the first anniversary date of the injury or illness. Before this point, consideration of a disability or medical retirement will have been explored.

#### **3-610.3.1 DISABILITY/MEDICAL RETIREMENT**

**Administrative and Operational Manual****September 12, 2022**

The Agency has a Disability Pension Plan as part of the Charles County Sheriff's Office Retirement Plans administered by the County. An explanation of Disability Retirement provisions are located within the following retirement plans.

- Sworn
- Correctional Officers
- Communications

The Non-Public Safety Plan does not contain a Disability Retirement provision.

The procedures for a Disability Retirement Review are contained within the "Charles County Sheriff's Disability Pension Plan" document amended and restated effective July 1, 1995.

An Employee Application is required. This form titled "Application for Disability Retirement" Form #860 is located on the Intranet under the forms section. An employee may submit an application or the Sheriff may apply in writing to the Disability Review Board recommending Disability Retirement under the Sheriff's Office Retirement Plan for an employee.

Additional terms and requirements are located within the "Charles County Sheriff's Disability Pension Plan" document amended and restated effective July 1, 1995. A copy of this document is available through the Human Resources Section. The Human Resources Administrator may answer any question regarding the Disability Retirement process.

### **3-610.4 BENEFITS AVAILABLE TO INJURED WORKERS - CIVILIAN EMPLOYEES**

It is the employee's responsibility to report on-the-job injuries to the Maryland Workers' Compensation Commission. The Commission makes a decision concerning any benefits due an employee as a result of an on-the-job injury. If the Commission determines the employee is entitled to compensation, the Sheriff will provide the following benefits:

- the Sheriff will pay the employee an amount necessary to make up the difference between the employee's workers' compensation check and his normal pay rate. This will be effective for the first thirty (30) calendar days an employee is away from work;
- the insurance carrier will pay medical costs incurred as a result of the employee's injuries up to the limits provided for by the Workers' Compensation Commission;
- should the employee be away from work for more than thirty (30) days, he will be allowed to use accrued leave at a rate equal to the difference between the workers' compensation check and the employee's normal pay rate. The employee may in this way continue to receive a combined amount from the Sheriff and the Workers' Compensation Commission equal to his normal rate of pay; and
- should the employee exhaust his accrued leave because of long-term injury under this section, the Sheriff may in his sole discretion advance sick and safe leave. If sick and safe leave were not advanced, the employee would then receive only the workers' compensation check. Employees who are receiving only a worker's compensation check must make arrangements to pay their portion of employee benefit payments. Benefits will lapse for those employees who do not make such payments.

### **3-610.5 EXAMINATION BY SHERIFF'S OFFICE CONTRACT PHYSICIAN**

All Agency sworn and correctional officers are required to submit to physical examinations prior to beginning employment. The Pre-Employment / Recruitment Unit will schedule these examinations with the Charles County Sheriff's Office's designated physician with the costs being paid by the Agency.

Any employee may be required at any time to submit to an examination, at the Agency's expense, by a Sheriff's



**Administrative and Operational Manual**

**September 12, 2022**

Office contract physician so the Sheriff may determine the ability of the employee to perform the essential functions of an assigned position. The need for this examination will be determined by the circumstances of the immediate case. A lack of compliance by the employee with such a directive is justification for removal of the employee from the position. Employees certified by the Sheriff's physician as fit for duty must return to work or vacate the position. Employee examinations which are paid for by the Agency shall be approved and scheduled by the Human Resources Section.

The Charles County Sheriff's Office encourages all of its employees to receive physical examinations on a regular basis.

**3-610.6 EMPLOYEE JOB-INDUCED PSYCHOLOGICAL DISORDERS**

In the event that an employee comes forward and states that he has been diagnosed by a mental health professional as suffering from a job induced psychological disorder, supervisors are instructed to follow the same reporting procedures as in injuries sustained on duty.

It shall be the appropriate Assistant Sheriff's responsibility to determine duty status and any further action (suspension, reassignment, modified duty, etc.), pending resolution of the case.

**3-611 MODIFIED DUTY**

An employee is considered to be in a modified duty status when he is unable to perform the duties and responsibilities required by his full-time position, and has been released by the attending physician to perform duties other than those assigned by the regular job description.

The policy of this Agency is to provide temporarily incapacitated employees with productive employment consistent with the Agency's needs and the employee's specific incapacitation. In the case of sworn police and correctional personnel, the policy is designed to ensure the safety of the incapacitated officer, fellow officers and the public, and to address liability issues.

**3-611.1 MODIFIED DUTY ASSIGNMENTS**

Every effort shall be made to provide employees who are injured in the line of duty with temporary modified duty assignments in accordance with their medical limitations.

Employees whose injuries are not work related may be given modified duty assignments when such work is available.

The following conditions will need to be met before a modified duty assignment request can be granted.

- The employee has submitted a Modified Duty Request and Authorization Form #690;
- The employee has submitted Physical and Functional Evaluation Form #169 completed and signed by a licensed physician.
- The Sheriff's approval is required if the initial request will exceed 30 days.

Once these requirements have been met, the employee may be offered a modified duty assignment, should one be available. Employees are reminded that employees injured in the line of duty will be given priority over non-work-related injury cases. Employees offered modified duty assignments resulting from a non-work-related injury will:

- Submit medical documentation every 30 days, updating work restrictions and listing an expected date of return to full duty;
- Comply with current policy and procedures concerning modified duty assignments.

**Administrative and Operational Manual****September 12, 2022**

If a modified duty assignment is unavailable for an employee injured outside the line of duty, the employee will be required to use leave. This policy will in no way be construed to mean modified duty is guaranteed.

Modified duty assignments will be coordinated through the Human Resources Section and the Commander / Director, Administrative Services Division, with the approval of the affected division commander / director. An employee will not be placed in a modified duty assignment without such coordination having taken place.

The procedures for considering placing a sworn, corrections, or civilian employee in a modified duty position are as follows:

- The employee being released for modified duty will report to Human Resources and provide Human Resources with a physician's release for modified duty, Physical and Functional Evaluation Form #169. The modified duty medical release must indicate:
  - the restrictions imposed on the employee during the modified duty assignment; and
  - the date for the next medical evaluation.
- The employee will complete the Modified Duty Request and Authorization Form #690 and submit it with the physician's modified duty release to the Human Resources Section;
- The Human Resources Section will contact the Commander / Director, Administrative Services to coordinate the employee's modified duty assignment, if available; and
- The Sheriff's approval is required if the initial request will exceed 30 days.

An employee who qualifies for FMLA leave cannot be forced to accept a modified duty assignment.

### **3-611.2 MODIFIED DUTY RESTRICTIONS FOR SWORN POLICE AND CORRECTIONAL OFFICERS**

All sworn police / correctional officers in modified duty assignments are subject to the following provisions:

- Modified duty assignments may not exceed one year and/or extend beyond the second anniversary date of the illness or injury;
- An officer in a modified duty assignment will be provided an assignment consistent with documented medical limitations. In some instances, the employee's current assignment may satisfy the modified duty requirements;
- The Agency uniform will not be worn during modified duty assignments. Officers will wear civilian attire as described elsewhere in the Manual. Any deviations will be approved by the division commander / director;
- An officer on modified duty assignment shall not operate a marked vehicle;
- Agency grooming standards will be followed, as outlined in AOM 3-554.

In addition to the above provisions, sworn police officers will also abide by the following:

- An officer may be authorized to work, but in an administrative capacity as outlined by a division commander in accordance with the employee's physical limitations;
- An officer in a modified duty assignment will take no law enforcement action unless failure to do so would likely result in the serious injury or death to the officer or another person;



**Administrative and Operational Manual**

**September 12, 2022**

- If one is available, an unmarked vehicle may be assigned to an officer on modified duty assignment, pending physician's release. Unmarked vehicles will be provided only to personnel who are on modified duty assignment due to a work-related incident.

**3-611.3 SECONDARY EMPLOYMENT WHILE ON MODIFIED DUTY**

For employees who are in a modified duty assignment, any continuation of secondary employment or entering into new secondary employment will require the employee to update and submit the following documentation to the applicable division commander / director:

- employment status (modified duty, etc.);
- name of secondary employer;
- number of hours worked per week; and
- detailed description of the nature of work performed in the secondary employment.

In the case of new secondary employment, such correspondence will accompany the Secondary Employment Request Form #185.

In determining if continuation of existing secondary employment or the approval of new secondary employment is appropriate, the division commander / director will consider the following:

- whether the secondary employment conflicts with the employee's ability to perform modified duty assignments;
- whether the secondary employment adversely affects the employee's return to his full performance regular work assignment; and
- whether the secondary employment involves the performance of functions or activities that the employee has been determined unable to perform in his full duty regular work assignments.

Secondary employment in a law enforcement / security-related capacity will not be allowed while an employee is on modified duty.

**3-611.4 DUTY STATUS – SWORN POLICE AND CORRECTIONAL OFFICERS**

In this section, "officer" refers to both sworn police and correctional officers.

An officer's duty status under this section is independent of modified duty under AOM 3-611. "Modified duty" is a work assignment; civilians and correctional employees, as well as sworn police officers, may be assigned to modified duty. "Duty status" in this section refers to a sworn police or correctional officer's ability to exercise their authority and powers because of psychological or physical limitations.

Whenever an officer is suffering from psychological or physical limitations that may impact the ability to perform the duties and functions of a correctional or police officer, the officer's division commander/director shall review the situation to determine if a change in the officer's status is warranted. The commander/director will consult with Human Resources. If the commander/director believes a change in status is warranted, the commander/director will prepare an e-mail or memorandum to the appropriate Assistant Sheriff recommending the change in status and the basis for the recommendation. The Assistant Sheriff will notify the division commander/director and Human Resources if there is to be a change in the officer's duty status.

All medical information reviewed for a change of duty status is confidential and shall not be disclosed outside of Human Resources, the Office of General Counsel, Assistant Sheriffs, the Chief of Staff, and the Sheriff.

There are three types of officer duty status:



Administrative and Operational Manual

September 12, 2022

- **Full duty:** the officer is able to perform all of the duties and functions of a sworn police or correctional officer.
- **Limited duty:** the officer is unable to perform some of the duties and functions of a sworn police or correctional officer because of temporary psychological or physical limitations. These limitations do not present an unreasonable risk to the individual, other employees, or the public.
- **Non-officer duty:** an officer who has had his police powers or correctional authority temporarily suspended due to the severity of the officer's psychological or physical limitations. These limitations could present an unreasonable risk to the individual, other employees, or the public.

**Limited Duty Status**

A sworn police or correctional officer will be placed on Limited Duty Status if:

- 1) A fitness for duty examination concludes that the officer has some level of restrictions which would cause him to be unable to perform some of the functions of a correctional or sworn police officer or a treating physician has completed a Physical and Functional Evaluation (Form #169) indicating the need for restrictions; and
- 2) An officer has requested consideration for limited duty because of a temporary disability; and
- 3) The officer's limitations do not present an unreasonable risk to the individual, other employees, or the public.

An officer placed on limited duty status may not take law enforcement action unless failure to do so would likely result in the serious injury or death to the officer or another person.

"Law enforcement action" includes:

- Making arrests;
- Conducting traffic or Terry stops;
- Participating in EST operations such as forcible entry.

"Law enforcement action" does not include:

- Applying for search warrants;
- Submitting applications for charges;
- Completing equipment repair orders.

An officer in limited duty status will not wear a uniform and will not drive a marked Agency vehicle.

An officer in limited duty status may qualify for a modified duty assignment, dependent upon his restrictions and the availability of an assignment.

**Non-officer Duty Status**

A sworn police or correctional officer will be placed in Non-Officer Duty Status if:

- 1) A fitness for duty examination concludes that the officer is unable to perform the functions of a police or correctional officer or a treating physician has completed a Physical and Functional Evaluation (Form #169) indicating the officer is unable to perform the functions of a police or correctional officer; and
- 2) The psychological or physical condition preventing the officer from performing the functions of a police or



Administrative and Operational Manual

September 12, 2022

---

correctional officer is expected to last for more than five days; and

- 3) The officer's limitations are determined to present an unreasonable risk to the individual, other employees, or the public.

An officer will also be placed in non-officer duty status if the officer's psychological or physical condition will prevent the officer from meeting the Maryland Police Training and Standards Commission's standards.

An officer in non-officer duty status is prohibited from taking police actions and will be required to surrender his Agency-issued firearm, badge, identification cards, MPTSC certification card, and will not operate an Agency vehicle with emergency equipment.

If the officer remains in non-officer duty status for 30 days, Human Resources will notify the Maryland Police Training and Standards Commission.

An officer in non-officer duty status may qualify for a modified duty assignment, dependent upon their restrictions and the availability of an assignment. However the officer may not be placed in an assignment which requires the use of police powers.

***Disagreement over change in duty status***

An officer who disagrees with a decision to change his duty status may file an appeal to the Chief of Staff in writing at any point while the status change is in effect. The appeal will be sent through the employee's Assistant Sheriff. The decision of the Assistant Sheriff will remain in effect unless and until the Chief of Staff makes a different determination. The appeal process is not available for a disagreement over modified duty assignments.



## Administrative and Operational Manual

September 12, 2022

### 3-612 FAMILY AND MEDICAL LEAVE ACT

The Sheriff's Office will provide family and medical leave protection as required by and in accordance with the Family and Medical Leave Act of 1993 (FMLA). An "eligible employee" of the Agency shall be granted up to 12 work weeks of leave during any 12-month rolling period for one or more of the following events:

- Because of the birth of a child of the employee and in order to care for such child;
- Because of the placement of a child with the employee for adoption or foster care;
- In order to care for the spouse, child, or parent of the employee if such spouse, child, or parent has a serious health condition; and/or
- Because of a serious health condition that makes the employee unable to perform the functions of the position of such employee.

#### 3-612.1 DEFINITIONS FOR FMLA PURPOSES

**Incapacity** - the inability to work, attend school, or perform other regular activities due to a "serious health condition," treatment therefore, or recovery therefrom.

**Parent** - the biological parent of an employee or an individual who acted in the capacity of a parent ("loco parentis") to the employee when the employee was a child.

**Son or Daughter** - a biological, adopted, or foster child; a stepchild, legal ward, or a "child" of a person acting as a parent ("loco parentis"). A child must be under the age of 18, unless the child is incapable of self-care because of a mental or physical disability.

**Spouse** - a husband or wife.

**Serious Health Condition** - an illness, injury, impairment, or physical or mental condition that involves:

- inpatient care in a hospital, hospice, or residential care facility; or
- a period of incapacity requiring absence of more than three calendar days from work, school, or other regular daily activities that also involves continuing treatment by, or under the supervision of, a health care provider, where the health care provider finds that the employee is unable to work at all, or is unable to perform any one of the essential functions of the employee's position; or
- any period of incapacity due to pregnancy, or for prenatal care; or
- any period of incapacity due to a chronic serious health condition (e.g., asthma, diabetes, epilepsy, etc.); or
- a period of incapacity that is permanent or long-term due to a condition for which treatment may not be effective; or
- any absence to receive multiple treatments (including any period of recovery therefrom) by, or on referral by, a health care provider for a condition that likely would result in incapacity of more than three consecutive days if left untreated.

Examples of specific conditions cited by the regulations include, but are not limited to: pre- and post-natal care, heart attack, heart conditions requiring bypass or valve operations, cancer, back conditions requiring extensive therapy or surgical procedures, stroke, severe respiratory problems, spinal injuries, pneumonia, emphysema, severe arthritis, severe nervous disorders, injuries caused by serious accidents on or off the job, treatment for allergies, stress, and substance abuse.





Administrative and Operational Manual

September 12, 2022

**12-Month Rolling Period** – as outlined in the Department of Labor’s FMLA Fact Sheet #28H, refers to a 12-month period measured backward from the date an employee uses any FMLA leave. Under the “rolling” 12-month period, each time an employee takes FMLA leave, the remaining leave entitlement would be the balance of the 12 weeks which has not been used during the immediately preceding 12 months.

*Example #1:* An employee requests three weeks of FMLA leave to begin July 31. The employer looks back over the past 12 months (from July 31 to the previous August 1) to see if any FMLA leave had been used. Since the employee had not taken any FMLA leave during the previous 12 months, he is entitled to the three weeks he requested, and has nine more weeks available.

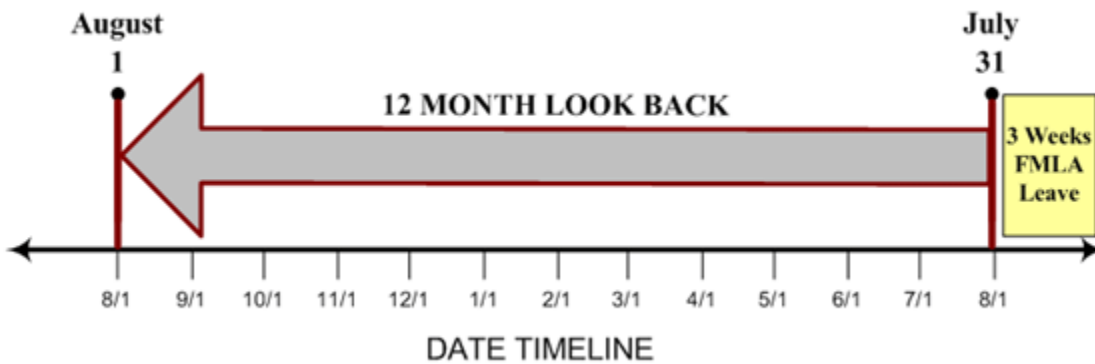

*Example #2:* Another employee requests two weeks of FMLA leave to begin on November 1. The employer looks back over the past 12 months (from November 1 back to the previous November 2) and sees that this employee had taken four weeks of FMLA leave beginning January 1, four weeks beginning March 1, and three weeks beginning June 1, for a total of 11 weeks during the previous year. She now has only 1 week of FMLA-protected leave available. After she takes the one week in November, the next FMLA leave she can take will begin January 1, as the days of her previous January “roll off” the leave year.

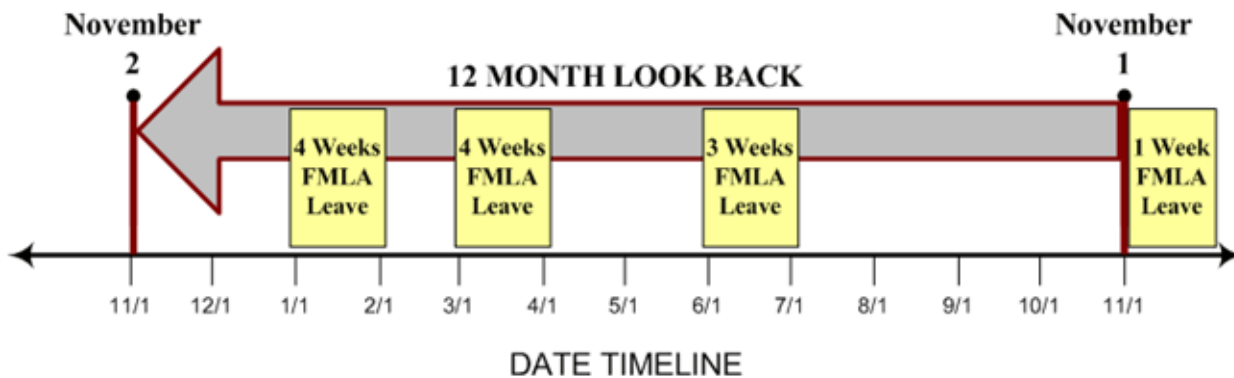

**3-612.2 ELIGIBILITY**

For purposes of FMLA, an “eligible employee” is an employee who has worked for the Agency for at least 12 months and has worked at least 1250 hours in the past 12 months.

**3-612.3 TYPES OF LEAVE UNDER FMLA**



## Administrative and Operational Manual

September 12, 2022

**Regular** - an employee needs time off for a continuous uninterrupted block of time (i.e., October 1 - December 8).

**Intermittent** - FMLA leave taken in separate blocks of time due to a single qualifying reason. This may be in the form of hours or days.

**Military Family Leave** – exceptions to FMLA to cover eligible employees whose spouse, son, daughter, or parent is on covered active duty or call to covered active duty status, which may extend the leave from 12 to 26 weeks under certain circumstances.

**Reduced** - a leave schedule that reduces an employee's usual number of working hours per work week, or hours per work day. A reduced leave schedule is a change in the employee's schedule for a period of time, normally from full-time to part-time.

If an employee needs to utilize intermittent or a reduced schedule type of leave, the Agency reserves the right to temporarily transfer the employee to a position with equivalent pay and benefits which better accommodate the employee's recurring leave.

### 3-612.4 MILITARY FAMILY LEAVE ENTITLEMENTS

Eligible employees whose spouse, son, daughter, or parent is on covered active duty or call to covered active duty status, may use their 12-week leave entitlement to address certain qualifying exigencies. Qualifying exigencies may include attending certain military events, arranging for alternative childcare, addressing certain financial and legal arrangements, attending certain counseling sessions, and attending post-deployment reintegration briefings.

FMLA also includes a special leave entitlement that permits eligible employees to take up to 26 weeks of leave to care for a covered service member during a single 12-month period. A covered service member is:

- a current member of the Armed Forces, including a member of the National Guard or Reserves, who is undergoing medical treatment, recuperation, or therapy, is otherwise in outpatient status, or is otherwise on the temporary disability retired list, for a serious injury or illness; or
- a veteran who was discharged or released under conditions other than dishonorable at any time during the five-year period prior to the first date the eligible employee takes FMLA leave to care for the covered veteran, and who is undergoing medical treatment, recuperation, or therapy for a serious injury or illness.

The FMLA definitions of "serious injury or illness" for current service members and veterans are distinct from the FMLA definition of "serious health condition". The National Defense Authorization Act for Fiscal Year 2010 expanded the definition of a serious injury or illness for both current service members and veterans to include serious injuries or illnesses that result from a condition that existed before the service member's active duty service and was aggravated by service in the line of duty on active duty. Employees should contact Human Resources Section for particulars pertaining to these definitions.

### 3-612.5 FMLA PROCEDURES

**Foreseeable Leave** - Employees anticipating an FMLA qualifying event must contact their immediate supervisor and Human Resources. The employee will receive the following items in an FMLA information packet:

- FMLA definition packet;
- Application for FMLA Leave Form #515;
- FMLA "Serious Health Care" form;
- U.S. Department of Labor Certificate of Health Care Provider form;
- Fitness for Duty Report #18; and
- "Your Rights under FMLA".



## Administrative and Operational Manual

September 12, 2022

Employees requesting FMLA should fill out the Application For Family or Medical Leave Form #515, and submit it to Human Resources 30 days prior to the start of leave. Applications for leave may be obtained from Human Resources.

**Unforeseeable Leave** - When the leave is not foreseeable, employees should notify their immediate supervisor as soon as practical (within one or two business days) of the need for FMLA leave. The request will then be forwarded to Human Resources for review.

Supervisors and Human Resources are required to ensure timekeepers are immediately informed of potential FMLA qualifying requests and sick and safe leave requests exceeding three consecutive days. Once FMLA is requested or it has been determined to be a possible FMLA qualifying event, the employee will receive the following information packet:

- FMLA definition packet;
- Application for FMLA Leave Form #515;
- FMLA "Serious Health Care" form;
- U.S. Department of Labor Certificate of Health Care Provider form;
- Fitness for Duty Report #18; and
- "Your Rights under FMLA".

Employees must complete the application form within 15 days of beginning the unforeseeable leave.

### 3-612.6 MEDICAL CERTIFICATION

An employee requesting leave under FMLA will provide certification as indicated in the Act. The U.S. Department of Labor Form WH-380, Certificate of Health Care Provider, will be used for this purpose. This form is part of the FMLA packet received by the employee. This certification must be completed and returned at least 30 days prior to the beginning of FMLA leave when leave is foreseeable. When leave is not foreseeable, the form must be submitted as soon as practical (one or two business days), following the FMLA leave request.

If necessary, this Agency may require a second examination by a health care provider of its choice, at its own expense.

Failure to provide medical certification when requested may result in denial of FMLA leave until such certification is received.

### 3-612.7 USE OF PAID AND UNPAID LEAVE

The Agency requires **all** leave (annual, compensatory, holiday, and sick and safe) be substituted for unpaid leave until all leave is exhausted.

The order in which leave is debited from the employee's accounts may vary based on the qualifying FMLA event.

If the event qualifies for the use of sick and safe leave, as stated in the section of this Manual addressing sick and safe leave, employees may debit their accrued sick and safe leave account first. If the event does not qualify for sick and safe leave, employees may debit their other accrued leave accounts first.

### 3-612.8 UNPAID LEAVE

Employees must first exhaust all of their accrued leave prior to going into an unpaid status during their FMLA leave. While on unpaid leave under FMLA, the employee will not earn annual, sick, or any other type of leave during a period of unpaid FMLA leave and is responsible to pay for insurance premiums, if enrolled in any of the Agency's



Administrative and Operational Manual

September 12, 2022

insurance plans.

Unpaid leave, while covered under the FMLA, is not the same as the Agency's Leave Without Pay Policy. An employee does not have to apply for unpaid leave during the specified 12-week period of FMLA.

### 3-612.9 REPORTING WHILE ON LEAVE

Employees on leave must contact Human Resources by the first and the fifteenth of each month regarding the status of their condition and intent to return to work.

The employee must notify Human Resources if there is a change in status or return date. Human Resources will keep the time keepers and supervisors informed of their employee's FMLA status whenever a change in status arises.

### 3-612.10 FMLA COORDINATION WITH WORKERS' COMPENSATION

Days off due to a work-related injury will be designated as FMLA leave if the criteria for FMLA leave is met.

Procedures for reporting injuries for Workers' Compensation remain unchanged.

### 3-612.11 EMPLOYEE STATUS AND BENEFITS DURING LEAVE

Employees who are being paid while on leave through use of their leave accounts will continue to have payroll deductions for health insurance premiums as well as any other deductions for programs the employee is participating in at time of leave (i.e., additional life insurance, retirement, bond deductions, etc.). The employee will also continue to earn and accrue annual and sick and safe leave in accordance with Agency policy.

Employees who are in an unpaid status during FMLA (either had no leave to use or their leave accounts have been exhausted), will be responsible for paying their portion of the cost of health, life, or other benefits provided as part of their employment. If the employee does not pay the outstanding health insurance premiums within 30 days of the due date, the employee's health insurance may be canceled due to non-payment of premiums. If the employee does not return to work at the end of FMLA leave that included an unpaid period, he will be required to reimburse the Agency for the payments made to cover the total cost of employee benefits.

### 3-612.12 SPOUSES EMPLOYED BY THE CHARLES COUNTY SHERIFF'S OFFICE

A husband and wife who are both employed by the Agency and are both eligible for FMLA leave may be limited to a combined total of 12 weeks of leave during the rolling twelve-month period if the leave is taken:

- for the birth of the employees' son or daughter or to care for the child after birth; or
- for placement of a son or daughter with the employees for adoption or foster care, or to care for the child after placement; or
- to care for an employee's parent with a serious health condition.

### 3-612.13 RETURNING TO WORK

Employees who have been out on FMLA leave for their own serious health condition and are now ready to return to work must submit to Human Resources a Fitness for Duty Report #18, which was included in their FMLA packet. It is an employee's personal responsibility to ensure that the evaluation form is completed and returned to Human Resources.



**Administrative and Operational Manual**

**September 12, 2022**

Employees returning from FMLA leave are entitled to be reinstated, if qualified, to the same or an equivalent position with equivalent pay, benefits, and other terms and conditions of employment.

**3-612.14 CONFIDENTIALITY OF MEDICAL RECORDS**

Any medical records obtained under the sick and safe leave policy or other Agency regulation will be collected and maintained on separate forms and in separate medical files. Such files will be treated as confidential medical records except that supervisors and directors of the employee may be informed regarding necessary restrictions on the work or duties of the employee and possible necessary accommodations. Further, first aid and safety personnel may be informed, when appropriate, if a medical condition might require emergency treatment. Medical files are held and secured by the Human Resources Administrator.

**3-613 COMPENSATORY LEAVE**

The rate of compensatory leave accumulation will be at one and one-half (1 ½) hours for each hour worked by non-exempt employees over forty (40) hours in one week. When approval is granted by the Division Commander for the crediting of compensatory leave, exempt employees will earn one (1) hour for each hour worked.

Sworn, Corrections and PCO's may accumulate up to 480 hours of compensatory leave and annual compensatory leave combined. All other Critical, Non Critical and Operational Employees may accumulate up to 240 hours of compensatory and annual compensatory leave combined. When an employee earns hours in excess of these maximums, the employee will receive pay for those excess hours.

The Agency shall not require any employee to use Compensatory leave on any day in which that employee has not made a request for Compensatory leave, except as outlined in existing policy.

Any compensatory time granted as a result of a government closing or for any other reason when granted by County Government will be accumulated as straight time.

**3-613.1 ANNUAL COMPENSATORY LEAVE BANK - SWORN**

Effective July 1, 2009, sworn members will have the option to select compensatory time rather than paid overtime. All compensatory time earned during the term of the Memorandum of Understanding (MOU) between the Agency and FOP, will be placed in the Annual Compensatory Leave Bank. During the term of the MOU members will not be permitted to accrue compensatory time except as provided in the following subsections.

Compensatory time is accrued at 1 ½ hours for each hour worked. Compensatory time accrued must be used during the calendar year in which it is earned. If for whatever reason the compensatory time is not used within the calendar year it is earned, the unused compensatory time will be converted to pay.

If a member has accrued any compensatory time under this subsection, it must be used before any annual leave is used; except that this subsection does not apply to holiday leave, sick and safe leave, personal leave, military leave, or administrative leave.

**3-613.2 USE OF COMPENSATORY LEAVE - SWORN**

Compensatory leave must be requested and approved in advance by the employee's supervisor and will be used in even increments of one-half (1/2) hour. No leave may be used before it is earned and credited to the employee's Compensatory leave account.

Compensatory leave requests for three (3) or less days off should be submitted to the employee's supervisor as soon as the expected use is known. Compensatory leave requests for more than three (3) days should be submitted at least fourteen (14) days before the first requested day off. All Compensatory leave requests for more than ten



**Administrative and Operational Manual**

**September 12, 2022**

(10) days must be approved by the employee's division commander / director or his designee.

Compensatory leave requests must be requested a reasonable period in advance. Supervisors will grant the employees' Compensatory leave requests on a first-come, first-serve basis until such time as the supervisor determines that the granting of any additional leave requests on the date in question would reduce the unit's staffing levels below the minimum personnel necessary for efficient operation. At that time, the reasonable period shall close, and the supervisor will deny additional requests for the use of Compensatory leave, as the operational functioning of the employee's unit would be adversely affected to the point of causing an undue disruption to that unit.

**3-613.3 ANNUAL COMPENSATORY LEAVE BANK - CORRECTIONS**

All correctional officers will have the option to select compensatory time rather than paid overtime. All compensatory time earned will be placed in the Annual Compensatory Leave Bank per CCCOA MOU. Correctional officers will not be permitted to accrue compensatory time except as provided in the following subsections.

Compensatory time is accrued at 1 ½ hours for each hour worked. Compensatory time accrued must be used during the calendar year in which it is earned. If for whatever reason the compensatory time is not used within the calendar year it is earned, the unused compensatory time will be converted to pay. An officer with an accumulation of less than one day at the end of the year will be paid.

If a member has accrued any compensatory time under this subsection, it must be used before any annual leave is requested or used; except that this subsection does not apply to holiday leave, sick and safe leave, personal leave, military leave, or administrative leave.

**3-613.4 ANNUAL COMPENSATORY LEAVE BANK - PCO's / POLICE STATION TECHNICIANS**

All Police Communications Officers and Police Station Technicians will have the option to select compensatory time rather than paid overtime. All compensatory time earned will be placed in the Annual Compensatory Leave Bank. Critical and operational employees will not be permitted to accrue compensatory time except as provided in the following paragraphs.

Compensatory time is accrued at 1 ½ hours for each hour worked. Compensatory time accrued must be used during the calendar year in which it is earned. If for whatever reason the compensatory time is not used within the calendar year it is earned, the unused compensatory time will be converted to pay.

If a member has accrued any compensatory time under this subsection, it must be used before any annual or holiday leave is used; except that this subsection does not apply to sick and safe leave, personal leave, military leave, or administrative leave.

**3-613.5 ANNUAL COMPENSATORY LEAVE BANK - ALL OTHER CRITICAL AND OPERATIONAL CIVILIANS**

All critical and operational civilian employees, excluding PCO's and Police Station Technicians, will have the option to select compensatory time rather than paid overtime. All compensatory time earned will be placed in the Annual Compensatory Leave Bank. Critical and operational employees will not be permitted to accrue compensatory time except as provided in the following paragraphs.

Compensatory time is accrued at 1 ½ hours for each hour worked.

Compensatory time accrued must be used during the calendar year in which it is earned. If for whatever reason the compensatory time is not used within the calendar year it is earned, the unused compensatory time will be converted to pay.



Administrative and Operational Manual

September 12, 2022

If a member has accrued any compensatory time under this subsection, it must be used before any annual or holiday leave is used, with the following exception. This does not apply when the employee uses the holiday leave earned on that holiday. This subsection does not apply to sick and safe leave, personal leave, military leave, or administrative leave.

**3-613.6 COMMUNICATIONS SECTION – WORK SCHEDULE / REQUIRED LEAVE USE**

Communications Section employees are paid based on a 40-hour work week. However, due to current scheduling provisions, employees within the Communications Section will, at times, be scheduled for less than a 40-hour work week. When this occurs, employees will submit a leave slip to bring their total hours that week up to forty (40). Employees must use leave for these hours in the following order:

- Annual Comp Leave
- Annual Leave or Regular Comp Leave
- Holiday Leave

This policy does not change current AOM policy pertaining to the use of leave in general. This policy is only intended to direct leave submittal dealing with those weeks the employee is not scheduled to work a 40-hour work week. If leave is requested beyond the first 4 hours to make up the 40-hour work week, other leave may be used if the employee's annual compensatory leave (ACL) balance is under 16 hours. If the ACL balance is 16 hours or over, then ACL must be used first.

**3-614 HOLIDAY LEAVE**

There are established 15 holidays for employees of the Sheriff's Office. In an election year, general Election Day creates a 16<sup>th</sup> holiday. These holidays are:

New Year's Day

Martin Luther King's Birthday

Lincoln's Birthday

Washington's Birthday

Maryland Day

Good Friday

Memorial Day

Juneteenth  
Independence Day

Labor Day

Columbus Day

Veterans' Day

Election Day

Thanksgiving Day



Administrative and Operational Manual

September 12, 2022

Day after Thanksgiving

Christmas Day

The holidays are scheduled according to a list published each year by the Charles County Government (not necessarily the traditional holiday).

**Non-Critical Employees**

With the exception of the two floating holidays identified below, non-critical employees are normally scheduled off on holidays and receive their normal pay for the holiday. However, non-critical employees may be directed to work as needed on a holiday. A non-critical employee directed to work on a holiday will receive an hour of compensatory time for each hour worked on that holiday. Notwithstanding job classification, certain employees may be required to work recognized holidays.

Lincoln's Birthday and Maryland Day are considered "floating" holidays. If a non-critical employee requests or is requested to work either of these holidays, the employee's supervisor must contact the Deputy Director, HR to check the status of the employee's compensatory leave bank. Non-critical employees who have a compensatory leave bank which is capped or will exceed the maximum cap limit by working a "floating" holiday are required to take off this holiday. Non-critical employees authorized to work on either of these two holidays will earn one hour compensatory time for each hour worked.

**Critical and Operational Employees**

Critical and operational civilian employees receive leave for the 15, or in election years 16 holidays.

For sworn and correctional officers, holiday leave accumulated under this section will reside in the holiday leave account. Sworn officers and correctional officers are bound by the FOP MOU and the CCCOA MOU and will refer to that document for details relating to current Holiday Leave provisions.

Police Communications Officers (PCO), Police Station Technicians, and Central Processing Specialists who work on Thanksgiving Day, Christmas Day, New Year's Day, or Easter will receive an additional four hours of holiday leave.

**Holiday Leave Accrual Rates – Critical and Operational Employees**

Police Communications Officers (PCO) and Police Station Technicians shall accrue Holiday Leave at a rate of 11.5 hours per holiday.

All other Critical Civilians shall accrue Holiday Leave at a rate of 8 hours per holiday.

All Operational Civilians shall accrue Holiday Leave at a rate of 7.5 hours per holiday.

Sworn police officers earn holiday leave at the rate of 10 hours per holiday in accordance with the FOP MOU.

Correctional officers earn holiday leave at the rate of 8.5 hours per holiday in accordance with the CCCOA MOU.

Newly hired sworn police officers and correctional officers will receive holiday leave on a pro-rated basis for the calendar year in which they are hired. They will only receive holiday leave for those holidays that have not yet passed, as of their hire date.

**3-614.1 HOLIDAY LEAVE ACCOUNT**

There is established a "holiday leave account" for each critical and operational employee. These employees receive holiday leave as defined in AOM 3-614. These hours will be credited to the holiday leave account effective on the





Administrative and Operational Manual

September 12, 2022

holiday. Holiday leave accumulated by these employees will reside in this holiday leave account.

Normally, the holiday leave account may not exceed 64 hours, and all hours over 64 would be lost without recourse to the employee. However, due to financial constraints or other factors, the cap can be removed for an indefinite period of time. It is the employee's responsibility to be aware of his holiday leave balance and request leave with sufficient notice so the employee's supervisor may effectively schedule that leave. In most cases, this will allow the employee a period of up to one year to use this holiday leave.

Employees will not be compensated for accrued Holiday Leave upon separation from the Agency.

Critical or Operational civilians moving to non-critical positions have one year from the transfer date to use any existing holiday leave.

### 3-615 PERSONAL LEAVE

In each calendar year, all full-time and full-time reduced hours' employees shall be entitled to personal leave days which may be used for any purpose and are subject to the following:

- Civilian full-time and full-time reduced hours' employees are entitled to 2 days of personal leave:
  - New hires will receive 2 days if hired prior to July 1, and 1 day if hired after July 1;
- All full-time civilian employees with a minimum of 10 years of service will receive an additional personal leave day annually, for an annual total of 3;
- Police Communications Officers and Police Station Technicians will receive 3 personal leave days annually:
  - New hires will receive 3 days if hired between January 1 and April 30; 2 days if hired between May 1 and August 31; and 1 day if hired between September 1 and December 31;
- Civilians, including PCO's and Police Station Technicians, shall use personal leave in entire shift / workday increments, equaling the number of hours the employee works in that normal workday;
- Sworn police officers, including officers in the ranks of Lieutenant and above, will receive 30 hours of personal leave, to be used in hourly increments;
  - New hires will receive 30 hours if hired between January 1 and April 30; 20 hours if hired between May 1 and August 31; and 10 hours if hired between September 1 and December 31;
- Correctional officers, including those officers in the ranks of Lieutenant and above, will receive a total of 25.5 hours of personal leave to be used in hourly increments;
  - New hires will receive 25.5 hours if hired between January 1 and April 30; 17 hours if hired between May 1 and August 31; and 8.5 hours if hired between September 1 and December 31;
- A request for personal leave may be denied due to staffing shortages;
- Personal leave not used by the end of the calendar year or upon separation from the Agency shall be forfeited without compensation or conversion to any other type leave;
- All requests for personal leave use will be documented on the Agency Leave Request Form #82, or requested through the TimeClock Plus system, under the category of Personal;
- Use of personal leave will be recorded on the employee's time record.



## Administrative and Operational Manual

September 12, 2022

### 3-615.1 OLD PERSONAL LEAVE - SWORN POLICE OFFICERS

For sworn police officers who have accumulated old personal leave, the leave will remain in an Old Personal Leave Account until used. The leave in this account does not expire, but no new personal leave will be accrued in this account. Leave in this account will be used in hourly increments. Employees will not be compensated for unused leave in the Old Personal Leave Account upon separation from the Agency.

### 3-616 ADMINISTRATIVE LEAVE

Administrative leave is that leave not charged to any of the employee's leave accounts, which is granted to the employee at the discretion of the Sheriff. Division commanders/directors can approve administrative leave as it pertains to death, funerals within the employee's immediate family and jury duty. All other granting of administrative leave requires the approval of an Assistant Sheriff, Chief of Staff or the Sheriff. Some examples of such grants are:

- So the employee may participate in a blood donor program;
- When an employee is injured in the line of duty (see 3-610.3);
- Bereavement leave in order for an employee to attend the funeral of one of the following relatives: aunts and uncles of the employee or spouse, nephews and nieces of the employee or spouse, and other persons on a case-by-case basis as approved by the employee's division commander/director;
  - One (1) day of administrative leave will normally be granted for this purpose;
  - In order for an employee to tend to the circumstances of a death in the employee's immediate family, four (4) days administrative leave are granted for this purpose;
  - No additional time will be granted as administrative leave; however, supervisors shall make reasonable efforts to arrange for the employee to take other authorized leave for this purpose if travel or other considerations are involved;
- Pending the investigation of any employee whose action(s) or use of force in an official capacity results in death or serious physical injury;
- Pending the decision of the Sheriff when an Administrative Hearing Board has recommended the employee be terminated;
- For the purpose of attending an educational course or program directly related to the employee's position with the Sheriff's Office and with the approval of the Sheriff;
- When weather conditions have caused the closing of the Charles County Government and in conjunction with the policy contained within this section addressing those occasions;
- At any time, it is deemed to be in the best interest of the public, the Agency or the employee.

**Note:** These examples are meant to be demonstrative and are not all inclusive.

### 3-616.1 CLOSINGS, DELAYED OPENINGS, OR EARLY DISMISSAL SITUATIONS

Closings, delayed openings, and early dismissals are intended to provide for employee safety during inclement weather or other conditions. All employees working in a facility not operated by the Agency shall follow the closing and delayed opening status of that facility. Those employees shall be granted administrative leave, when applicable.

#### 3-616.1.1 OPERATIONAL STATUS CODES AND EMPLOYEE NOTIFICATIONS FOR INCLEMENT WEATHER OR OTHER UNUSUAL SITUATIONS

The following codes will be used to notify employees of the Agency's operational status. During inclement weather or other unusual situations, code notifications will be sent out by Agency-wide email and posted on the Agency web site. For critical and operational employees only, the operational status code is subject to change



Administrative and Operational Manual

September 12, 2022

during their affected shift(s).



Normal Operations



Delayed opening / early dismissal – Agency will announce start or dismissal time.



Liberal Leave in effect for Non-Essential, Non-Critical Employees - Employees should notify their Supervisor of Intention to use Liberal Leave.



All Offices Closed for Non-Essential, Non-Critical Employees.

**NORMAL OPERATIONS – CODE GREEN** – Normal daily operations, all employees report for shifts as scheduled.

**DELAYED OPENING / EARLY DISMISSAL – CODE YELLOW** – During delayed openings, non-essential, non-critical employees will not report to work prior to the start time designated. During early dismissals, non-essential, non-critical employees will leave work at the designated dismissal time. Non-essential, non-critical employees will report to work as scheduled if the employee's normal start time is unaffected by the designated start time/dismissal. Administrative leave will be based on the employee's normal working hours. See the examples below for further explanation. All critical employees (FT, FTRH, and PT) will report to work (or remain at work). Operational employees must report to work based on the directives of their division commanders / directors.

Examples of how delayed openings affect employees are as follows:

- If the employee's normal work day begins at 0800 hours, and the scheduled delay does not allow an employee to report to work until 1000 hours, the employee will be granted two (2) hours of administrative leave to cover those two (2) hours.
- If the employee's normal work day begins at 1000 hours, and the scheduled delay does not allow an employee to report to work until 1000 hours, the employee receives no administrative leave and should report on time. That employee's work day is not affected by the delayed opening.
- If the employee's normal work day begins after the delayed opening, such as 1100 hours, then the delayed opening has no effect on that employee. The employee will not receive any administrative leave and would report to work as usual.

Examples of how early dismissals affect employees are as follows:

- If an employee's normal work day ends at 1600 hours and the scheduled dismissal is at 1400 hours, the employee will be granted two (2) hours of administrative leave to cover those two (2) hours.
- If an employee's normal work day ends at 1500 hours and the early dismissal is scheduled for 1500 hours, the employee will receive no administrative leave and should leave at their normally scheduled time. That employee's work day is not affected by the early dismissal.
- If the early dismissal is scheduled for a time after an employee's regular dismissal time, the employee will not be affected by the early dismissal.

**LIBERAL LEAVE AUTHORIZED – CODE ORANGE** – Employees should notify their supervisor of their intention



Administrative and Operational Manual

September 12, 2022

to use Liberal Leave. If a FT or FTRH non-critical employee chooses to take leave for any period not included in the announced administrative closing, delay, or early dismissal, the leave taken will count only for that period and the employee will be credited for administrative leave for the remainder. Administrative leave will be based on regularly published work schedules and made only for the number of hours of any such announced administrative closure.

For example: If a delayed opening of two hours with liberal leave is announced, an employee who is scheduled to work an 8-hour shift may choose to take the remainder of the day off and be charged for only six hours of leave.

**CLOSING – CODE RED STATUS** – Non-Essential, Non-Critical employees are **not** permitted in Agency facilities without an Assistant Sheriff’s approval. These employees do not have the option of deciding if they want to come in to work. All critical employees (FT, FTRH, and PT) will report to work (or remain at work) for their scheduled hours. Operational employees must report to work based on the directives of their division commanders / directors.

**3-616.1.2 EMPLOYEE COMPENSATION FOR CLOSURES, DELAYED OPENINGS AND EARLY DISMISSALS**

When the Charles County Sheriff’s Office closes, delays opening, or announces an early dismissal of administrative operations for any period, and places the employees in an administrative leave status, the Sheriff will compensate the Sheriff’s Office employees in the following manner:

- All critical and required operational employees (FT, FTRH, and PT) who report to work (or remain at work) as scheduled will receive compensatory time at the rate of one hour for each hour of closure, delayed opening, or early dismissal. Compensatory time will be based on regularly published work schedules and made only for the number of hours of any such announced administrative closure. In no case will the credit of compensatory leave exceed twelve (12) hours for any 24-hour period.
- Non-Essential, Non-critical employees (FT, FTRH, and PT) will not report to work (or remain at work) during any closure, delayed opening, early dismissal, or CODE RED status. They will receive administrative leave for all such instances.

Any employee already on pre-approved leave, sick and safe leave, or who has called in sick or been placed on sick and safe leave, will be charged for leave as previously requested and will not receive administrative leave or compensatory time, except that the Sheriff may grant administrative leave when such leave is awarded as a part of a holiday or special occasion.

The Sheriff may declare closing, delayed opening, or early dismissal of Agency employees independent of the actions of the Charles County Commissioners. In these instances, all aforementioned accounting procedures prevail.

**3-616.2 ADMINISTRATIVE LEAVE PENDING AN INTERNAL INVESTIGATION**

When an employee has been placed on administrative leave pending an internal investigation, the employee must provide a telephone number they can be reached at during weekday business hours from 0800 - 1600. The employee must be available to respond to a requested location within one hour. Reasonable consideration will be given for the location of the employee’s residence.

Any employee whose action(s) or use of force in an official capacity, results in a death or serious physical injury will be placed on administrative leave. Additionally, this policy extends to all officers affected by any traumatic incident experienced while working in an official capacity. Officers placed on administrative leave due to use of force or traumatic incidents will be required to have a psychological evaluation and must be cleared, prior to returning to duty.

**Administrative and Operational Manual****September 12, 2022**

Officers involved in incidents where their duty weapon is recovered for evidentiary purposes will have that weapon replaced with another agency weapon by the Commander, Training Division or designee if they are not placed in a non-officer status. Officers will be required to qualify with the new weapon as soon as practical.

### **3-617      MILITARY LEAVE**

The Sheriff recognizes the importance of military service and specifically the commitment of the National Guard members and reservists employed by the Agency. This policy is established to provide necessary scheduling flexibility for those affected, while maintaining adequate resources to accomplish the goals and mission of the Charles County Sheriff's Office.

The following requirements are in compliance with the Uniformed Services Employment and Re-employment Rights Act of 1994, commonly referred to as USERRA. According to USERRA, to be protected under the Act, employees using military leave must:

- have given written or verbal notice to the Agency prior to the need for leave, except when precluded by military necessity;
- not have exceeded the five-year cumulative limit on periods of service (not including time spent for required drills, annual training, and other skills training the reservist participates in). Some military orders are specifically exempt from the five-year standard;
- have been released from military service honorably; and
- reported back to work in a timely manner, as outlined under USERRA guidelines.

Per the FOP MOU:

- Effective July 1, 2009, an officer who is a member or who becomes a member of a United States Military Reserve or National Guard Unit can receive paid military leave up to fifteen (15) work days, either consecutively or non-consecutively, per calendar year when ordered to participate in annual training exercises. Five (5) of the leave days may be used for weekend drill. These are paid leave days and not subject to gap pay.
- Effective July 1, 2011, five (5) military leave days may be carried over to the next calendar year if such leave was not used in the previous calendar year. Any additional days will not carry over, nor will they be eligible for compensation. No more than twenty (20) days may accumulate in a calendar year.
- Officers are permitted to use their Agency vehicles to commute out-of-county for military purposes, after first notifying the Assistant Sheriff of Operations through the proper chain of command. Other applicable conditions can be found in the MOU.

#### **3-617.1      ADVANCE NOTIFICATION OF DUTY**

Due to the critical nature of the employee's position within the Charles County Sheriff's Office and the possible necessity of reaching an employee while on military leave, the employee must provide certain information to his supervisor or division commander / director and Human Resources. The following information will be provided at the time of hire, when an employee joins the armed forces, or when a reservist changes reserve units:

- the name of the employee's reserve unit commander;

**Administrative and Operational Manual****September 12, 2022**

- the location of the employee's reserve unit; and
- a phone number where the commander of the military unit may be reached by the employee's division commander / director.

Employees of the Sheriff's Office who are called to active duty are required to give written or verbal notice of the upcoming absence to their immediate supervisor prior to the beginning of the absence. Employees are required to notify their supervisor immediately upon receiving orders. A copy of the orders will be forwarded to the Deputy Director, Human Resources.

Employees will not be asked or required to find a replacement for their scheduled shifts when taking leave for military purposes.

For military activations / deployments exceeding 180 days, the following protocol will be followed. This protocol may also be followed for military activations/deployments less than 180 days as deemed necessary by the Sheriff or his designee.

- The Deputy Director, Human Resources will be the employee's point of contact during deployment, and a process for communication with the deployed member will be established;
- The Deputy Director, Human Resources will provide the employee with a Deployment Checklist, Form #167, detailing what actions are required before deployment, during deployment and post-deployment;
- The employee and Deputy Director of Human Resources will utilize the Deployment Checklist Form #167 to make sure required issues are addressed before, during and after deployment. Each section of the checklist details the person or section responsible for a list of items needing to be addressed or secured. The employee, Deputy Director of Human Resources and the employee's Commander / Supervisor will all have copies of the checklist for their records.
- The Commander / Director, Administrative Services or designee, will arrange for out-processing, including an exit interview, as well as the in-processing at the end of the deployment, including a re-entry interview;
- The employee will arrange for storage of Agency-owned equipment during deployment, by following the instructions listed on Form #167 Military Checklist. Equipment required to be turned in for safe storage during the employee's absence should include all Agency-issued firearms, tasers, MDTs or laptops, Agency key cards, Agency employee identification cards, portable radios and vehicles;
- The Training Division will be notified by Human Resources of the employee's upcoming deployment dates. Upon the employee's return, the employee will be temporarily assigned to the Training Division. The Training Division will provide any necessary initial or refresher training, weapons qualifications, and steps for reintegration, as appropriate. The employee will review and sign off on policy changes through the PowerDMS system.

### **3-617.2 SCHEDULED MONTHLY DRILLS**

Members of the National Guard who have an advance schedule will provide that to their supervisor, along with any other information helpful in planning for the employee's absence. A copy of the employee's drill schedule and Active Duty Training (ADT) will be forwarded to Human Resources and placed in the employee's personnel file.

If the employee provides a written drill schedule to his supervisor and division timekeeper which remains the same each month and covers a significant period of time, the supervisor will not require a separate leave request for each drill. However, if the employee wishes to use any accrued leave to be paid for this time, the required leave must be submitted for the supervisor's approval in order for accrued leave use to be approved. This information is necessary for timekeeping purposes.



## Administrative and Operational Manual

September 12, 2022

---

### 3-617.3 FIVE-YEAR CUMULATIVE SERVICE

Employees will not be eligible for protection under USERRA if their cumulative length of military service while working for the Agency exceeds five years. Some military orders are specifically exempt from the five-year standard.

**NOTE:** Mandated National Guard and reserve training requirements and service performed on active duty during times of war or national emergency are excluded from this limitation.

### 3-617.4 HONORABLE RELEASE

Any employee of this Agency who receives or has previously received a dishonorable discharge from any military service will not be eligible for protection under USERRA.

### 3-617.5 TIMELY RETURN TO AGENCY DUTIES

Employees who participate in military service are required to report back to work within a specified length of time as defined under USERRA guidelines. Employees not meeting the listed time constraints in returning to work once their tour of duty has ended are considered Absent Without Leave (AWOL).

To be eligible for protection under USERRA, the service member must report back to work within the following guidelines:

- **1-30 days of service:** Report to work next scheduled work day after safe travel and 8 hours rest.
- **31-180 days of service:** Report to work within 14 days after completion of service.
- **181+ days of service:** Report to work within 90 days after completion of service.

The employee must notify the Human Resources Section and their commander / director of their planned return date.

### 3-617.6 RETURN FROM MILITARY DUTY

Any employee on military duty for a period of thirty (30) days or more is required to submit to Human Resources a copy of orders received for release from active duty (DD-214) prior to returning to the Sheriff's Office. USERRA allows the Agency to request a copy of military orders showing the date of release from duty and a copy of the certificate of satisfactory performance of military duties to ensure the criteria for protection under USERRA are met.

Employees who were deployed in a designated combat area or where hostile action occurred are subject to a post-deployment psychological evaluation and physical exam by designated Sheriff's Office physicians. This is an early intervention program designed to identify officers who may be suffering from "Combat Stress." Results of exams are kept confidential and any further treatment will be coordinated through the military.

Supervisors should be cognizant that "Combat Stress" may occur in military personnel returning from active duty in a combat zone and observant for any of the following indicators:

- anger;
- irritability;

**Administrative and Operational Manual****September 12, 2022**

- difficulty concentrating;
- loss of confidence;
- sadness;
- isolation;
- fear.

Early intervention is key to effectively reducing Combat Stress reactions and the onset of Post-Traumatic Stress Disorder.

**3-617.7 MILITARY LEAVE WITH PAY**

Any employee who is a member or becomes a member of a United States Military Reserve or National Guard Unit can receive paid military leave up to fifteen (15) work days, either consecutively or non-consecutively, per calendar year.

Weekend drill and annual training exercises qualify for Military Leave With Pay, up to fifteen (15) days. Leave used for weekend drill and annual training exercises in excess of fifteen (15) days shall be requested as Military Leave Without Pay, or other accrued leave may be utilized if available.

In order to receive payment for the fifteen (15) days, the employee must submit a copy of military orders to the Human Resources Section prior to taking leave. The Deputy Director, Human Resources will review and, once approved, forward the orders to the Deputy Director, Accounting Section for processing.

If the employee does not contact Human Resources and produce orders, the leave will be recorded as Military Leave Without Pay.

While an employee is on Military Leave With Pay, all benefits to the employee remain the same. The employee continues to accrue sick and safe leave and annual leave and will continue to be enrolled in the County's health plan if already a participant.

**3-617.8 MILITARY LEAVE WITHOUT PAY**

Any employee who is a member or becomes a member of the United States Military Reserve or National Guard Unit will be placed on Military Leave Without Pay when the fifteen (15) days of Military Leave With Pay for weekend drill and annual training exercises has been exhausted, and the employee is called to another exercise within the same calendar year. Other accrued leave may be utilized if available and requested by the employee.

While an employee is on Military Leave Without Pay, the employee will not accrue sick or annual leave during this unpaid leave period. It will be the responsibility of the division timekeeper to track and document Military Leave Without Pay for the purpose of leave accrual.

If the employee is a participant in the County's health plan, the employee may elect to continue coverage through the period of leave without pay. This can be arranged by contacting the County Benefits Administrator.

Contributions to the retirement plan will not be made during any period of Military Leave Without Pay; however, upon returning to duty, the employee shall be allowed to make up missed deferrals or contributions. The employee shall be allowed a period equal to three times the period of military service, but not longer than five years, to make up the contributions. County Government will match any such contributions, but is not obligated to credit the employee with any interest which would have been otherwise earned.

All periods of Military Leave Without Pay will be considered continuous service with the Agency for the purposes of years of service and/or retirement eligibility





**Administrative and Operational Manual**

**September 12, 2022**

**3-617.9 USE OF LEAVE OTHER THAN MILITARY LEAVE**

An employee may elect to use accrued leave in lieu of Military Leave With / Without Pay. This leave will then be deducted from the selected accrued leave account.

Time used for military leave may not be deducted from any of the employee's leave accounts unless specifically requested by the employee.

**3-617.10 GAP PAY**

In cases where employees are called to full-time military service, and where funds are available within the Sheriff's budget for such purposes, it is the intent of the Agency to provide the employee with Gap Pay in order to supplement the difference between military pay and the employee's Agency salary. In order that this may occur, the employee must provide the Deputy Director, Accounting Section a copy of the employee's military pay voucher, or other acceptable evidence of the employee's military salary. Every effort will be made to provide this supplemental income as consistently as possible; however, the employee may use Agency available leave during times when the Gap Pay may not be available.

Employees may elect to continue health care coverage with the County during times when they are receiving Gap Pay. The employee must contact the County Benefits Administrator to confirm any decision in this regard.

Vacation or sick and safe leave will be accrued by the employee while receiving Gap Pay.

Employees on active military duty will have pension contributions suspended. Upon return to active employment with the Agency, the employee has the option of repaying missed contributions to the pension plan.

Otherwise eligible employees may return to their former positions when they leave military service.

**3-618 EMPLOYEE LEAVE DONATION PROGRAM**

This policy establishes a program whereby a CCSO employee may transfer accrued leave (annual, sick or compensatory) directly to another CCSO employee who has exhausted, or will exhaust during a specific absence, all accrued leave and is facing an extended absence without pay brought about by the employee's illness, injury or disability. The amount of leave donated, combined with the employee's accrued leave, generally should not exceed the designated FMLA standard of twelve (12) weeks.

However, in rare instances, such as military family leave, an employee may be granted additional donated leave to account for a prolonged absence. In those rare cases, an employee or a designee shall make a request to the Sheriff through Human Resources with supporting documentation from a treating physician on the employee's condition and the anticipated date of return. Human Resources will then review the request as well the employee's sick and safe leave record and personnel file and prepare a report outlining the situation, employee's employment history and any information concerning leave issues within one week of receiving the request. The report will be forwarded to the Sheriff for a review. The Sheriff will then make a final decision to either grant or deny donated leave accrual beyond the twelve (12) weeks.

Once a decision has been reached, Human Resources will notify the requesting employee of the Sheriff's decision.

**3-618.1 ADMINISTRATION - LEAVE DONATION PROGRAM**

The Employee Leave Donation Program will be administered by the Human Resources Section in coordination with Agency timekeepers.

The division commander / director of the affected employee will solicit leave throughout the Agency and forward



**Administrative and Operational Manual**

**September 12, 2022**

leave donations to Human Resources. Human Resources will coordinate the transfer of donated leave among the requesting employee, the timekeeper, and the leave donor.

An employee is not eligible to receive leave donations for absences that are covered by workers' compensation due to a work-related injury or illness.

The Leave Donation program works in conjunction with the Agency FMLA policy, where applicable. An employee who meets the criteria for FMLA will remain protected under the FMLA while on leave, regardless of the type of leave. In addition, if an employee does not receive any leave donations or is out of leave, he will continue to be protected under the FMLA as explained in the section addressing FMLA.

All accrued leave will be used first before any donated leave will be used.

No more than thirty (30) workdays of donated leave may be accumulated at any one time. Only the Sheriff or a designee may approve any extension of this thirty (30) day limit and only one extension, limited to thirty (30) days, will be granted.

### **3-618.2 LEAVE DONATIONS**

All leave donations shall be voluntary and will be made directly to the requesting employee. The division's timekeeper will record the donated leave as it is received. Every precaution will be taken to ensure that any excess hours donated shall remain in the leave account of the employee donating the leave.

No employee may donate more than one-half of his accrued annual, sick, or compensatory time to the requesting employee.

### **3-618.3 PROCEDURES - REQUESTING EMPLOYEE**

A request for leave donations must be submitted in writing to the division commander / director by the employee or by a representative acting on behalf of the employee. The request is then directed to Human Resources. All requests must be accompanied by:

- a physician's statement which indicates the nature of the illness, injury or disability and the period of time the employee will be unable to work; and
- the employee's leave record verifying all available annual and sick and safe leave has been or will be exhausted.

Any employee who has received formal counseling regarding the abuse of sick and safe leave shall not be eligible to receive donated leave.

Division commanders / directors have the responsibility to review all requests for leave donations, make recommendations and forward them to the Human Resources Section for consideration and final disposition.

### **3-618.4 PROCEDURES - DONATING EMPLOYEE**

Any employee wishing to donate leave to another employee shall complete a Leave Request Form #82 indicating the following:

- type of leave to be transferred (sick, annual or compensatory);
- under "Other – Specify" indicate "Donation" and recipient's name; and
- number of hours being donated.

The completed form shall be forwarded to the donor's supervisor for approval.

**Administrative and Operational Manual****September 12, 2022**

Employees separating from the Agency for any reason will not be allowed to donate unused leave for present or future use.

**3-618.5 ADMINISTRATIVE PROCEDURES**

A request for leave transfer will be processed in the same manner as a request for annual leave within the donor's division:

- requests will be approved after verification the donor has sufficient leave to support the donation;
- an appropriate deduction will be made to the donor's leave record by the division timekeeper; and
- a copy of the approved Leave Request will be forwarded to the timekeeper of the employee requesting the leave and credited to the requesting employee's leave record.

**3-619 LEAVE WITHOUT PAY**

Leave without pay (LWOP) may be requested by any full-time or full-time reduced hours employee and shall be approved or disapproved by the Sheriff. LWOP shall be granted only when the interests of the CCSO are served and the employee intends to return to the CCSO on or before the expiration of the LWOP request. LWOP requests under FMLA are an exception and procedures specified in that section of this policy shall be followed.

- An employee on LWOP may not earn annual, sick, or any other leave during a pay period of unpaid leave;
- All accumulated leave must be exhausted before consideration of granting LWOP;
- Following a leave of absence without pay, a reinstated employee shall begin work with no accumulated leave credit. Leave accruals shall begin once the employee is in pay status;
- Contributions shall not be paid into the retirement plan during any period of unpaid leave;
- If an employee granted LWOP wishes to continue coverage under the County health insurance program, he must make arrangements with the County Payroll Office for payment of the employee's contribution toward the monthly premium;
- An employee on LWOP may return to active status before the expiration with the approval of the Sheriff;
- LWOP may be granted to an employee by the Sheriff in conjunction with Workers' Compensation because of a long-term injury. The employee must exhaust his accrued leave, at which time the Sheriff may advance sick and safe leave or approve LWOP;
- Periods of leave without pay shall be deducted from the employee's anniversary date and his service credit;
- Any employee absent because of LWOP for a period of ninety or more days shall be subject to a physical examination and supplementary background investigation before being permitted to return to work;
- The duration of this leave shall not exceed one (1) year.

**3-619.1 PROCEDURES – EMPLOYEE**

Requests for LWOP must be submitted in writing three weeks prior to the starting date and contain the following



Administrative and Operational Manual

September 12, 2022

information:

- the employee's name, ID number, assignment, and date of request;
- the basis for requested leave of absence;
- the dates when LWOP is requested to begin and end; and
- the position held at the time of request.

All documents substantiating the request should be attached to the employee's letter (doctor's certificate, etc.). The employee's memorandum shall be submitted through the chain of command.

### 3-619.2 PROCEDURES - SUPERVISORS / COMMANDERS / DIRECTORS

Each supervisor shall process the employee's request within three (3) workdays of receipt. Each supervisor in the chain of command shall attach a document stating whether this request should be approved or denied and justification for that decision.

The division commander / director shall review all documents and respond within three (3) workdays. The division commander / director shall indicate, in writing, whether this request should be accepted or rejected in whole or in part. All documents / recommendations shall be forwarded to the appropriate Assistant Sheriff.

The Assistant Sheriff shall review the documents and consult with the supervisory staff involved, to resolve any issues. Within two (2) days of receipt of the documents, the Assistant Sheriff shall forward the documents, along with his recommendation, to the Sheriff.

The Sheriff will determine whether to accept, return, or reject in whole or in part the request by the employee for LWOP. The Sheriff shall notify the employee in writing of his decision within five (5) days. The Sheriff's decision is final and binding. Copies of the Sheriff's memorandum shall be sent to the employee's supervisors, the Assistant Sheriff, and Administrative Services. All original documents pertaining to this matter shall be maintained in the employee's personnel file. Copies shall be forwarded to Administrative Services.

- Once approval is granted, the employee may continue coverage under the health insurance programs. However, the employee is responsible for contacting the Payroll Office of County Government in order to make payments towards his monthly premium contribution.
- The employee is responsible for notifying the Agency of his intended return to duty date within five (5) days after the expiration of leave without pay. This notification will be made to the Sheriff along with copies to the employee's supervisory staff. Failure to make this notification may be grounds for termination.
- If the employee is unable to assume the same duties held prior to the LWOP, the employee must notify the Sheriff of this fact. If a placement cannot be accomplished, steps will be taken to separate the employee if the employee is not eligible for retirement.
- Sworn employees granted LWOP shall:
  - have their police powers suspended;
  - shall not operate a Sheriff's Office vehicle;
  - shall not wear the uniform; and
  - shall not work law enforcement / security-related secondary employment.

Issued equipment shall be turned in to the Agency Quartermaster, who will store it until the expiration of the granted LWOP.



Administrative and Operational Manual

September 12, 2022

### **3-620 TUITION REIMBURSEMENT PROGRAM**

The purpose of this program is to provide an effective and consistent method of providing a means of tuition reimbursement to Sheriff's Office employees. This procedure establishes a standardized method to be followed by all eligible employees for the application, approval and reimbursement of tuition for approved courses. These guidelines will be followed whenever an eligible employee applies for benefits under the Tuition Reimbursement Program.

#### **3-620.1 EMPLOYEE DEVELOPMENT**

The Charles County Sheriff's Office believes the continued development of its employees is important to the success of the Agency and paramount to upgrading existing levels of service, as well as to providing new services. The Sheriff's Office Tuition Reimbursement Program is a strategy for developing employees who will then enable the Agency to achieve its long-term goals.

#### **3-620.2 ELIGIBILITY**

To qualify for benefits, the employee must be a full-time or a full-time reduced hours employee. To be eligible to receive benefits under the Tuition Reimbursement Program, the employee must have successfully completed his initial probationary period.

#### **3-620.3 COURSE CRITERIA**

Courses covered by the Tuition Reimbursement Program must be credit courses that are job-related. Job-related is defined as a course of instruction which must have a direct bearing on the employee's work assignment or be related to an Agency position to which the employee may reasonably expect to progress. Courses that are required to obtain a degree related to the employee's current job or to an Agency position to which the employee may reasonably expect to progress are also covered by the Tuition Reimbursement Program.

Courses shall be credit courses and be offered at an accredited institution. Other non-credit classes, classes that are assigned continuing education units (CEUs), and seminars are considered "technical training" and should be considered for payment under the Agency training budget.

All courses should be taken during a time that does not conflict with an employee's assigned work. It is understood that an employee's first responsibility is to his assignment with the Agency.

#### **3-620.4 FINANCIAL REIMBURSEMENT AND COSTS COVERED**

An employee is eligible to receive reimbursement for up to 12 credit hours to a maximum reimbursement of \$1,200.00 per fiscal year.

Tuition reimbursement is limited to tuition and textbook costs only. Tuition and textbooks will be reimbursed at 100%. Reimbursement does not apply to other charges, such as registration fees, activity fees, transfer fees, or lab fees associated with courses.

Should the employee be eligible to receive any other financial assistance, i.e., G.I. benefits or scholarships, the Agency reimbursement will be reduced by that amount for tuition / textbook costs up to \$1,200.00.

Example:

An employee enrolls in an approved course of study with an associated tuition / textbook cost of \$750.00. The employee receives a scholarship in the amount of \$400.00. The Agency would reimburse the employee only \$350.00. If the tuition for a course is \$2,200.00 and the employee receives G.I. benefits totaling \$1,000.00, the

**Administrative and Operational Manual****September 12, 2022**

employee would still be eligible to receive the maximum Agency benefit of \$1,200.00.

**3-620.5 REQUIRED GRADES**

To be eligible to receive tuition reimbursement, the employee must receive a passing grade, C or better for undergraduate, and B or better for graduate courses.

**3-620.6 SERVICE COMMITMENT**

Employees who receive this benefit will be required to reimburse the Agency on a pro-rated basis, should they separate from Agency employment in the one-year period following the completion date of the course.

**3-620.7 APPLICANT RESPONSIBILITIES**

An employee must submit a Tuition Reimbursement Program Funding Request (Form #245A) to the Deputy Director, Human Resources Section prior to October 1 in the year preceding the fiscal year in which tuition assistance is being requested. For example, if an employee is seeking tuition assistance for FY-2019 (July 1, 2018 – June 30, 2019), Form #245A must be submitted prior to October 1, 2017. Once the form is approved, it will be forwarded to the Deputy Director, Budgeting, for inclusion in the upcoming fiscal year budget. This funding is not guaranteed and is contingent upon approved budgeted funding.

An employee must complete and submit a Tuition Reimbursement Application (Form #245) to his supervisor at least three (3) weeks before the course commences and obtain approval prior to enrollment in any course. A copy of the course description(s) from the school's catalog and completed school registration form must be attached to the application form. If a course is not directly job-related but is required for a degree, some form of acceptance to the degree program must also be attached. Once the courses have been completed, a final grade(s) report must be submitted to the Human Resources Section to begin the payment process as outlined in AOM 3-620.11 through 3-620.13.

**3-620.8 SUPERVISORY RESPONSIBILITIES**

The supervisor of the employee requesting tuition assistance will review the application to verify the employee meets eligibility and course criteria requirements. The supervisor will then sign the form, indicating the application is either recommended for approval or disapproval and forward it to the division commander / director within three (3) working days of receipt from the employee.

If the application is not recommended for approval, the supervisor must provide a written explanation stating the reason the course(s) was not recommended for approval.

**3-620.9 COMMAND RESPONSIBILITIES**

The division commander / director should receive the application within three (3) working days of the employee submitting the form. Upon review of the application, the commander / director will sign the form, indicating the application is either recommended for approval or disapproval. The commander / director will then forward the application form to Human Resources within two (2) working days of receipt from the supervisor.

If the application is not recommended for approval, the division commander / director must provide a written explanation stating the reason the course(s) was not recommended for approval.

**3-620.10 HUMAN RESOURCES RESPONSIBILITIES (APPROVAL PROCESS)**



**Administrative and Operational Manual**

**September 12, 2022**

Human Resources will review the application for compliance with all guidelines. If all guidelines are met, Human Resources will process the request and return a copy of the approved application to the employee and to the division commander / director (or designee).

If the application is disapproved, Human Resources will advise the employee of the reason for disapproval, in writing, within two (2) weeks from the date of disapproval.

**3-620.11 REPORTING RESPONSIBILITIES**

When an employee has successfully completed an approved undergraduate or graduate level course, the employee will submit a copy of the final grade report within two (2) weeks of receipt to Human Resources.

**3-620.12 HUMAN RESOURCES RESPONSIBILITIES (PAYMENT PROCESS)**

Human Resources will review the grade report and attach it to the employee's original Tuition Reimbursement Application. If it meets the required guidelines, the payment request section will be completed and signed. A copy of the Tuition Reimbursement Application requesting payment will then be forwarded to the Deputy Director, Budgeting Section. The Deputy Director, Budgeting Section or designee will see the request is forwarded to Accounts Payable for undergraduate classes or to Payroll for graduate level classes.

If the request for payment is not in compliance with approved guidelines or if the tuition reimbursement payment is disapproved, Human Resources will advise the employee of the reason for non-compliance or disapproval, in writing, within two (2) weeks.

**3-620.13 PAYMENT - GRADUATE LEVEL COURSES**

The tuition reimbursement payment will be made in conformance with the County's accounts payable policies for all undergraduate and graduate courses.

It is Sheriff's Office policy to follow all IRS regulations, and is hereby stated any future changes to the IRS regulations regarding tuition reimbursement will be followed. Any changes of this nature will not require a formal change to this policy. Employees will be notified of changes related to taxability of this benefit by written notice to divisions.

This benefit is dependent upon availability of funds in the current fiscal year budget.

**3-621 SWORN AND CORRECTIONAL EMPLOYEES' EDUCATIONAL INCENTIVE PAY PROGRAM**

There is established an Educational Incentive Pay Program to encourage sworn and correctional employees of the Sheriff's Office to obtain relevant college degrees, and to attract to the Agency, as entry level employees, those persons who may already have acquired such degrees. Course work must be taken at a college or university accredited by the Commission on Higher Education, Middle States Association of Colleges and Secondary Schools, or a comparable organization having jurisdiction over other parts of the country. At a minimum, to qualify, an employee must have sixty (60) credit hours.

An employee who obtains an Associate Degree or sixty (60) credit hours in a degree program may receive an annual payment of seven hundred fifty dollars (\$750.00). An employee who obtains a Bachelor's Degree may receive an annual payment of one thousand five hundred dollars (\$1,500.00). This policy is predicated upon the availability of funds. In times of budget crises where the funds are not available for educational incentive pay, the Sheriff may suspend such payments.

To qualify for this program, an employee must have submitted the Educational Incentive Program Application Form #244. The application must be accompanied by an official transcript, in a sealed envelope from the college (may be mailed or hand carried), supporting the information contained in the application. Forms must be submitted to Human Resources by October 1 in order that the monies to fund the request be placed in the budget for the fiscal



**Administrative and Operational Manual**

**September 12, 2022**

---

year beginning the following July. Applicant employees who receive the Sheriff's approval generally receive a check in July and December each year for half of the eligible amount. Employees must be eligible before the beginning of the fiscal year (July 1) to receive any education incentive pay in that year.





Administrative and Operational Manual

September 12, 2022

### 3-627 EQUAL EMPLOYMENT OPPORTUNITY

The Charles County Sheriff's Office is committed to providing equal employment opportunities for all of its employees as well as for those who apply for Agency jobs. No employee or applicant will be discriminated against because of age, race, sex, color, religion, creed, national origin, political opinion, marital status, or other factor not based on merit.

### 3-628 FILLING PERSONNEL VACANCIES

The Sheriff is the sole authority for the approval of staffing of the various positions within the CCSO. Human Resources shall continually monitor all positions within the Agency in order to advise the Sheriff, through the Commander / Director, Administrative Services, concerning factors which impact the staffing of these positions.

Staffing considerations include the responsibility to create, fill, maintain or abolish positions, based upon the need to provide a particular service, required of the Sheriff by law or community expectation. It is inherent in this responsibility to provide these services in the most economical way practical, while maintaining an effective and professional level of the delivery of services. In this regard, each position should be evaluated to determine if it must be occupied by a sworn officer, corrections officer, civilian employee, or contract employee.

There are many economic, legal, and professional criteria which may impact the decision to choose any of the aforementioned categories of staffing. Human Resources shall thoroughly research those criteria when making staffing recommendations. Additionally, they will develop a position description containing the essential functions for each authorized or proposed position which accurately defines the position. In addition to the essential functions, the position description will define the pay grade / salary range of the position, whether or not the position is exempt or non-exempt, its place in the organizational structure (reports to and responsible for), the general hours of work, any license or certification requirements, any prerequisite education, experience, or skill requirements, and any other criteria necessary to define the position.

In no case is there a requirement for a particular position to be filled simply because it is vacant. If, in the opinion of the Sheriff, an appropriate candidate has not been found, or there is other cause to temporarily leave the position vacant, then the position may remain vacant until such time as the Sheriff directs it be filled.

Division commanders are authorized to make reassignments of personnel under their command. The division commander shall make notification to Human Resources no later than 48 hours after the reassignment is made.

#### 3-628.1 MOVEMENT OF PERSONNEL

The Sheriff retains the right to make organizational transfers and reassignments which in his sole discretion and opinion are in the best interests of the Charles County Sheriff's Office.

#### 3-628.2 DEFINITIONS

**Transfer** - A change in job function (duties) which entails a major revision in the scope of duties and responsibilities necessary to complete the assigned tasks. Also, movement from one location to another, within the same position.

**Transfer examples:**

- A sworn police officer is moved from a position as a patrol officer to a position as an investigator, at the same pay grade, in CID. This move is a transfer.
- A Lieutenant is moved from a position as the Commander, Communications to a position as the Commander, Community Services. This move is a transfer.



Administrative and Operational Manual

September 12, 2022

- A correctional officer is moved from Squad A, Team 4 to Transport. This move is a transfer.

**Reassignment** - A movement of personnel not involving a transfer.

**Reassignment examples:**

- A sworn police officer is moved from Squad A, Shift 1 at District 1 to Squad G, Shift 3 at District 1. This move is a reassignment.
- A correctional officer is moved from Squad B, Team 3 to Squad A, Team 1. This move is a reassignment.

### 3-628.3 TRANSFER / REASSIGNMENT OF SWORN POLICE AND CORRECTIONAL OFFICERS - SERGEANT AND BELOW

If a position is to be filled by a sworn police or correctional officer and that position is above the entry level position for officers, it may be filled by reassignment or transfer. Entry level positions and those filled by promotion are covered by procedures defined elsewhere in this Manual.

Transfers to fill positions will normally be made using the requests for transfer that are on file with the Administrative Services Division. If there are no requests currently on file to fill a vacancy, or those applying do not meet the requirements or are considered not eligible, the vacancy may be announced or the Sheriff may transfer a sworn police or correctional officer to fill the vacancy. If the vacancy exists as a result of a newly created position, the vacancy will normally be announced in sufficient time for all eligible sworn police or correctional officers to submit a transfer request.

Eligible officers may at any time make known their desire to be transferred to a new position. This will be accomplished by submitting a Request for Transfer or Reassignment Form #301 to Human Resources. No more than two transfer requests will be permitted on file.

To be considered eligible:

- Sworn police officers must be off entry level probation and have three years of experience as a sworn law enforcement officer;
- Correctional officers must be off entry level probation and have three years of experience as a certified correctional officer.

When completing the Form #301, "Division Requested" AND "Section or Assignment" must be completed. Requests that indicate the requested division only will be returned to the officer.

For example: An eligible officer may request a transfer to Criminal Investigations Division (CID) / Investigations Section or CID / Narcotics Enforcement Section. If the officer wants to request both of the above assignments, a Form #301 must be completed for each assignment. When applying for transfer to Special Services, at minimum the Section must be indicated; the officer may also request Unit / Domestic Violence, Warrants, etc.

Transfer requests within the Corrections Division will normally be within the Division, with the exception of Court Security Officer, which is assigned to the Special Services Division.

Other transfer requests will indicate Section and Position; i.e., Support Services Section / Transport or Court Holding, etc.

A separate Form #301 must be submitted for each position requested. Since there is a maximum of two requests allowed active at any time, a third request must indicate which of the previous is to be rescinded. This is to be done by checking the "yes" box in the last paragraph of the Form #301. The officer must then explain which position

**Administrative and Operational Manual****September 12, 2022**

previously requested is to be rescinded.

The transfer request file will be maintained by the Human Resources Section. Officers may at any time contact Human Resources to verify their most current transfer request.

Each October, the transfer request files will be audited and all transfer requests that have been on file for three (3) years or longer will be removed from the file. It will be the officer's responsibility to resubmit a transfer request if he so chooses. As soon after October 1 as feasible, each officer participating in the transfer request process will receive written verification of his transfer request status.

When an officer is promoted from Corporal to Sergeant, any transfer requests on file will be deleted. The Sergeant may then submit a transfer request for a different supervisory position if he so chooses. When an officer is promoted from Sergeant to Lieutenant, any requests for transfer will be deleted. Lieutenants wishing to be considered for a position other than the one they are currently serving in may formulate the request in letter or memorandum format to their Assistant Sheriff via their chain of command.

Each time Human Resources receives a Form #301 from an officer, a copy will be returned to the officer to verify receipt. An officer may only apply for transfer to positions which are to be staffed at the officer's current rank. In addition to meeting rank criteria for a particular transfer opportunity, the officer must also meet any selection criteria for the new position.

### **3-628.4 TRANSFER / REASSIGNMENT SELECTION PROCESS**

Commanders may obtain a current listing of those officers who have made known their desire to transfer to a particular position by initiating a request to the Administrative Services Division. This list may then be used to select personnel to fill a position vacancy.

Eligible candidates on file in the transfer database for the particular position will be considered. The selection process will include the following:

- Agency personnel file;
- performance ratings;
- training records;
- formal education;
- knowledge, skills, and abilities;
- pending investigations;
- disciplinary actions; and
- personal interview.

The date a transfer request was submitted may or may not be included in the selection criteria.

### **3-628.5 CIVILIAN VACANCIES**

In most circumstances, civilian vacancies which occur within the CCSO will be announced. Announcements will generally be in-house only, i.e., within the Agency and Charles County Government, if the position is above entry level. In some cases, when the anticipated response to an announcement is expected to be low, the announcement may be made simultaneously in-house and to the general public.

Responses to such announcements by current employees of the CCSO will be made using the Request for Transfer or Reassignment Form #301. The Form #301 shall be submitted to Human Resources on or before the closing date indicated on the announcement for the position. Announcements for entry level positions will always be made both publicly and in-house. Announcements of vacancies will define, at least in general terms, salary requirements,



Administrative and Operational Manual

September 12, 2022

skills, and qualifications for the position.

If a competitive process is to be used, Human Resources shall conduct or coordinate this process. The final approval shall remain the responsibility of the Sheriff. Civilian employees may only submit a transfer request for positions which have been announced. No database of transfer requests is maintained for civilian positions.

Civilian positions are not subject to the consideration of rank as are sworn and correctional officer positions. Civilians may therefore apply for transfer to any position for which they meet the basic qualifications.

**Voluntary Grade Reduction**

When an employee applies for a position with a lower grade, it is considered a voluntary grade reduction through the recruitment process. An employee who is selected for a lower graded position will receive a decrease in pay according to the following sliding scale:

Number of Grades of Reduction	Percent Decrease
1	6%
2	9%
3 or more	12%

If the reduction in an employee's salary is higher than the maximum pay on the salary scale even with the percentage decrease, the employee's salary will be further reduced to the maximum salary of the grade for that position.

**In-Grade Transfer**

If an employee transfers to a position at the same grade level as the one they are currently serving in, they will retain the same salary.

**Promotion**

An employee who is promoted competitively to a new position in a grade higher than his current position, will receive an increase according to the following sliding scale:

Number of Grades of Promotion	Percent Increase
1	6%
2	9%
3 or more	12%

The employee's salary would increase according to the sliding scale or the minimum of the new, higher grade, whichever is greater (percentage increase or minimum of grade). The salary increase cannot place the employee's pay above the maximum salary of the new grade. If a promoted employee's salary increase would surpass the maximum of the grade, the increase will be limited to the maximum salary of the grade.

Promotions will be effective the first full pay period following the approval of the promotion.

**NOTE:** When a position is grant funded, that specific salary amount will be advertised. Grant positions will be paid at the funded amount. All in-house announcements will advise whether a position is grant funded or not.

**Reclassification**

When a position is changed to a lower grade for reasons such as reclassification, the incumbent will retain the same rate of pay. If the incumbent's rate at the time of a change is higher than the maximum rate for the new grade, the incumbent's rate will be retained and redlined.

**Administrative and Operational Manual****September 12, 2022**

When a position is changed to a higher grade due to a change in the position, in the classification plan, or a classification error, the incumbent will be placed in the higher grade, without competition, using the same sliding scale as noted under the Promotion section of this policy.

**Position Upgrade**

When an employee has been approved by the Sheriff to receive a position upgrade (career ladder advancement) they will receive a salary increase in the same manner as noted under the Promotion section of this policy. As an example, this would apply when a PCO I has been approved for a position upgrade (promotion) to PCO II.

**3-628.6 CIVILIAN SELECTION PROCESS**

The process by which a person is selected to fill a particular position is a formal one. Prior to the announcement of a vacancy several preliminary matters must be assured:

- There must be a valid position on the current staffing document appropriate to the announcement;
- There must be a current or expected vacancy in at least one such position;
- There must be a current valid position description for the position;
- There must be a valid series of interview questions and rating form for the position.

When a vacancy occurs, Human Resources will prepare and distribute the announcement and receive the Form #301. Human Resources shall initiate the competitive process and coordinate its completion.

All lists of eligible candidates will have an expiration date. During the life of the appropriate list, candidates may be selected from that list without the need to re-announce or interview.

**3-628.7 PAY CONSIDERATIONS - TRANSFERS**

If an employee is transferred, i.e., moved from a current position to one which is at the same pay grade or salary range as the one the employee currently occupies, the employee will be maintained at his current pay structure. If there are some other financial considerations which were connected with the position from which the employee is moving, then the employee will lose them as a result of the move.

If there are some financial considerations connected with the new position, the employee will receive them. For example, a sworn officer is transferred from uniform patrol to investigations. He will lose the normal shift differential associated with working rotating shifts in patrol. Then, as an investigator, he will receive the clothing allowance associated with the investigative assignment and will receive shift differential based on the hours he is assigned specifically to work, hours which qualify for shift differential.

**3-630 SECONDARY EMPLOYMENT**

Employment with the CCSO requires employees to work irregular schedules which are subject to change in order to meet staffing needs. It is necessary for employees to have adequate rest and to be alert while working. Because of this, employees are restricted from working certain secondary employment which inherently conflict with the employee's primary responsibility to serve the Agency and the citizens of Charles County. The Agency may also restrict employees from working secondary employment as security officers or police as a disciplinary measure.

Secondary employment will never be considered an excuse for poor performance, absenteeism, tardiness, or refusal to work overtime.

**3-630.1 APPLICABILITY**

This policy shall apply to all employees of the Charles County Sheriff's Office. It is applicable to all secondary



## Administrative and Operational Manual

September 12, 2022

employment regardless of the length of the term or the temporary nature of that employment.

### 3-630.2 DEFINITIONS

**Secondary Employment** is defined in the context of this policy as any work performed or any service rendered, outside of duties assigned by the Sheriff or command structure of the Agency, for money or other remuneration. This would include any work performed by the employee in a business or company where the Agency employee is a stock holder, sole proprietor, partner or other owner / worker.

**Security or Police-Related** is defined as that employment in which there is a reasonable expectation of the use of police powers. Such employment would not normally be offered to the employee if he were not a sworn police officer. Examples would be as security at Board of Education dances or ball games, as a watchman at a car lot or construction site, or as protection against shoplifters at a department store.

**Non-Security Related** is defined as employment which has no bearing on the employee's police powers, and the exercise of police powers during this employment would be surprising and unusual. Examples would be as a carpenter, painter, shoe salesman, bus driver, or waterman.

### 3-630.3 EMPLOYEE APPLICATION PROCESS

Any employee wanting to work secondary employment will submit a Secondary Employment Request, Form #185, through the chain of command to his division commander / director. The division commander / director will forward the Form #185 to the Assistant Sheriff of Administration for final approval. Once approved, no additional action is necessary to maintain approval.

Final distribution of the Form #185 will be as follows:

- Original to Assistant Sheriff of Administration, who will manage an Agency-wide database;
- Copy to Human Resources for placement in the employee's personnel file; and
- Copy to the requesting employee

If immediate approval is needed during the evening or on a weekend and the employee's division commander / director is not available, the Form #185 may be submitted to the section / shift commander for approval. If approved, it shall be for a period not to exceed 72 hours. If the secondary employment is to continue beyond the 72-hour emergency approval, the employee must resubmit a Form #185 through the normal approval process.

This process provides the employee an opportunity to work secondary employment on short notice. However it should never interfere with the needs of the Agency and must be appropriate and compatible with the Agency's policies and primary mission.

In any case where an employee's request to work secondary employment is denied, the employee shall have the right of appeal to the Sheriff. The appeal shall be in the form of a memorandum addressed to the Sheriff stating the circumstances of the appeal. A copy of the original Form #185 should be attached.

### 3-630.4 SECONDARY EMPLOYMENT LOCATION APPROVAL

Each secondary employment location must be approved before an Agency employee can work there. Each location will have one Agency employee who is identified as the manager of that secondary employment site. A Secondary Employment Location Request, Form #185.1, will be submitted through the chain of command to the Assistant Sheriff of Administration requesting approval for each location. For any new location to be added to the approved list, the employee identified as the manager for the location shall be responsible for the submission of the Form #185.1. Once a location has been approved, it will be added to a database of all security or police-related locations. The database will be managed by the Assistant Sheriff of Administration and will be available on the Agency Intranet to allow employees interested in working secondary employment to determine if a location has been approved.



## Administrative and Operational Manual

September 12, 2022

When a secondary employment site is no longer active, the manager of that site will submit Form #185.1 with the block "site inactive" checked along with the date. The form will be forwarded through the chain of command to the Assistant Sheriff. This will effectively remove this secondary employment site from the list of active sites.

### 3-630.5 PROHIBITIONS AND RESTRICTIONS

Security-related secondary employment is generally not permitted during an employee's probationary period. However, lateral officers with two years of prior police experience may apply for and be approved to work secondary employment once they have been approved to work as a solo officer. In no case shall a sworn employee be permitted to engage in secondary employment related to security or police work, unless the employee has attended an Academy and successfully completed field training.

If an employee's sick and safe leave records reflect the employee's health has hindered their ability to be attentive to the responsibilities of his primary work, secondary employment will be denied.

No employee in a modified or non-officer status may work police or security related secondary employment. No employee may engage in secondary employment which would amount to being paid by the Sheriff and another employer for the same time period.

No employee shall engage in secondary employment where their position may have a coercive effect on individuals interacted with. For example, collection of debts, civil process service, private investigations (including accident investigations), providing bail bond, insurance, etc. No employee may be owner or part owner of any business which engages in such activities.

No employee may work as a police or security officer representing any side in a labor dispute. Unless acting under a contract through the Agency, a sworn employee may not work as a police or security officer for any other county, municipality, or other political subdivision. (This section does not apply to duties related to U.S. military reserves or National Guard activities.) No employee may work as a police or security officer for a private company whose place of business is outside of Charles County.

If a secondary employment location is a private or corporate business enterprise (as contrasted with a not-for-profit charitable, religious or civic enterprise), Sworn officers shall not engage in the sale or service of alcoholic beverages.

In no case will an employee engage in secondary employment that could bring discredit, disrespect, or disfavor from the public in general upon the Agency or its members. Although the circumstances of this requirement may be difficult to determine, the responsibility to maintain public trust and confidence in the Agency and its members requires that employees be extremely conservative in their decisions regarding secondary employment. The fact that approval for a particular secondary employment has been obtained, does not relieve the employee from responsibility for this requirement. The employee is in the best position to evaluate and continually monitor the ongoing conditions of a particular secondary employment position to ensure it is in compliance with the requirements and spirit of this section.

No employee may engage in secondary employment where the employee's access to Agency records or information is a factor. Employees may not gain a business advantage nor profit in any way from the access to such information or records. No employee may disregard or violate Agency rules as a result of secondary employment.

Supervisors and all other employees are reminded the work of the Charles County Sheriff's Office is the primary employment for all. Supervisors shall consider adequate staffing when granting leave requests for employees to work secondary employment.

Security or police-related secondary employment may be suspended or prohibited by a commander / director or an Assistant Sheriff as a disciplinary tool, subject to the Public Safety Article for sworn employees.

**Administrative and Operational Manual****September 12, 2022****3-630.6 LIMITATIONS**

No employee is permitted to engage in secondary employment which may have a detrimental effect upon the employee's performance of his duty functions. This would include, but is not limited to, length of time spent in secondary employment, the physical activity necessary, the mental stress, or job pressures.

**3-630.7 UNIFORMS AND VEHICLES AT SECONDARY EMPLOYMENT**

Sworn officers approved to work secondary employment in security or police-related positions must wear the authorized patrol shift uniform. Officers shall also carry all required equipment as if reporting for duty.

No specialty uniforms (EST, Bike Patrol, etc.) are to be worn while working secondary jobs. Exceptions to the uniform requirement for specific locations or details must be requested and justified during the approval process. A specific request and justification to wear civilian clothing at secondary employment must be submitted via memo to the Assistant Sheriff of Administration. K-9 officers are permitted to wear their specialty uniform when their K-9 partner is present at the secondary employment. If the K-9 partner is not present, K-9 officers will wear the authorized patrol shift uniform.

Sworn employees who are approved to work secondary employment in security or police-related work in civilian clothing will carry an approved firearm, badge, Agency ID Card, Maryland Police Training Commission Card, handcuffs, and the Agency portable radio. It is highly recommended the employee wear issued body armor and carry the issued collapsible baton, OC Spray, and extra ammunition for the firearm.

Use of an Agency vehicle during secondary employment requires prior approval. Use of the vehicle shall be strictly limited to only those tasks that are necessary. Excessive use of an Agency vehicle during secondary employment may result in revocation of approval. An Agency vehicle may be used to travel to and from the fixed location of the secondary employment and for limited movements about the location. The vehicle may be occupied by the employee while parked; however, the engine of the vehicle will not remain running for any extended period of time.

**3-630.8 SECONDARY EMPLOYMENT NOTIFICATION**

Sworn employees working secondary employment in any police or security capacity shall, prior to the start of such employment, notify the police station technician for the district in which the secondary employment assignment will take place. This notification may be made by telephone or in person.

The technician will be provided with the following information:

- the location (address);
- the name of the business (if applicable);
- the hours the employee will be working.

The technician will initiate a "Secondary Employment" event, and enter all information provided by the officer.

When securing from secondary employment, the officer may contact the district station or Communications to clear the event. However, officers shall be responsible for verifying they have been logged off the secondary employment assignment.

Failure of the officer to make this notification may result in disciplinary action, up to and including loss of the privilege to work secondary employment. Police Station Technicians who are responsible for entering this information into Agency computer systems are also subject to disciplinary action for failure to complete this function.

Communications personnel, upon beginning a tour of duty, shall familiarize themselves with locations and officers currently on a secondary employment assignment.





Administrative and Operational Manual

September 12, 2022

### 3-630.8.1 REPORT OF POLICE ACTION

When an officer working secondary employment takes police-related actions, the officer will notify Communications. The Communications PCO will start an event in the CAD system under the officer's ID number. When the situation is completed, the officer will clear the event with a disposition code. This includes any police action at the secondary employment site or anywhere the officer might respond.

### 3-630.9 GAMBLING SITES

Employees working secondary employment at locations where games of chance resulting in monetary winnings to participants are played are required to ensure there is a valid gambling permit on site. Any violations noticed by employees while working at these sites will be reported to the person in charge. If the violations continue, the district supervisor or, the section / shift commander, will be immediately notified and the employee will cease the secondary employment.

The notified supervisor will cause the appropriate action to be taken to deal with the violation(s). In the case where the reporting employee is sworn, an incident report will be completed by the reporting employee documenting the circumstances of the violation(s) and a copy forwarded to Narcotics / Vice. In the case where the reporting person is not sworn, the notified supervisor will cause a report to be made and a copy forwarded to Narcotics / Vice.

### 3-630.10 LIABILITY CONSIDERATIONS

When employees work secondary employment, they should consider the question of liability for their acts on behalf of the secondary employer. They should also consider the consequences of accidents and injuries which they may sustain in the performance of their secondary employment. The Charles County Sheriff's Office will assume no liability for an employee's actions or injuries sustained as a result of activities on behalf of, or at the direction of, secondary employers.

Employees should consider what they have to lose (including the ability to work for the Agency), and take steps to ensure the secondary employer will provide protection for injuries or civil suits arising from the secondary employment. The secondary employer should provide Workers' Compensation and liability insurance to the employee.

### 3-630.11 SWORN RESPONSIBILITIES

Sworn employees have responsibilities inseparable from their oath of office which may not be disregarded because the employee is working secondary employment. If an incident arises which requires law enforcement action during the course of the secondary employment and that action is not associated with or compatible with the secondary employment duties of the employee, the employee must take such actions as are required by his duties to the Sheriff and the citizens of Charles County.

Minor incidents which did not or are not occurring on the secondary employer's premises and do not require immediate law enforcement action may be handled by an on-duty officer. Communications may be notified of the need for an on-duty officer. Otherwise, incidents which occur as a result of the secondary employer's operation, or on the secondary employer's premises, will be handled by the employee working secondary employment. An on-duty supervisor or commander may, under exigent circumstances, direct an incident to be handled by on-duty personnel.

Emergency situations, regardless of location or relationship to secondary employment, will be handled by the employee as if in a duty status. Employees will then be compensated by the Agency for any arrest, transport, processing time, and any subsequent court time associated with the incident. Officers, starting at that point, shall not continue to be compensated by both the Agency and the secondary employer.



Administrative and Operational Manual

September 12, 2022

### **3-630.12 NON-SWORN RESPONSIBILITIES**

Non-sworn employees are prohibited from working in any secondary employment capacity which is prohibited to sworn employees, unless they can demonstrate no conflict with their duties or other detrimental influence will prevail because of their engagement in the secondary employment. Non-sworn employees shall not wear uniforms or equipment associated with their employment with the Charles County Sheriff's Office.

### **3-630.13 DOCUMENTING, MONITORING, AND AUDITING OF SECONDARY EMPLOYMENT**

The Office of Professional Responsibility (OPR) shall be responsible for monitoring all secondary employment.

The Commander, OPR shall ensure random review of secondary employment is conducted. In this regard, occasional inspections of locations and operations of businesses approved for secondary employment will be made. The activities of employees will be observed in order to determine if they comply with this policy and are in accordance with those described on the approved Form #185.1. As a result of such audits, the Commander will report any discrepancies or problems to the Assistant Sheriff of Administration.

The Commander, OPR will ensure an annual review of secondary employment is conducted, and present a written report to the Assistant Sheriff of Administration and Sheriff by February each year, outlining the secondary employment of Agency employees for the previous 12 months.

### **3-639 PATROL OFFICER FIELD TRAINING PROGRAM**

The successful completion of the Patrol Field Training Officer (FTO) Program is required of every sworn patrol officer and will begin once the officer has met the following:

- Completion of mandated Police Academy Training;
- Completion of Agency specified training for newly hired sworn officers;
- Overview of the FTO Program.

The Patrol Field Training Officer Program is based on the essential functions of a Police Officer I and is meant to ensure each officer will have received the necessary training, supervision, and guidance under field conditions to meet the high standards of the Agency.

#### **3-639.1 PATROL FTO PROGRAM RESPONSIBILITY**

A Patrol Administrative Sergeant will be selected as coordinator of the FTO program. The FTO Coordinator is responsible for the overall daily operation and administration of this program. Specific responsibilities of the FTO Coordinator include selecting the curriculum, maintaining records, providing Agency specified training, and acting as a liaison between the Agency and Academy staff. The Commander, Training Division, in conjunction with the Patrol Shift Commanders will continually evaluate the FTO Program to improve its effectiveness toward providing the newly sworn officer with the experience and skills necessary to complete the program. Details of this program may be found in the FTO SOP.

#### **3-639.2 PATROL FTO PROGRAM DESCRIPTION**

The Patrol Field Training Officer Program requires systematic and organized activities that educate and train newly hired officers. The program consists of on-the-job training, classroom training, and numerous evaluations throughout the process. The program is designed to replicate, as nearly as practicable, those conditions a police officer will be presented with on solo patrol. It takes into consideration previous life experiences, whether as a cadet, a member of the military, or an officer from another agency.



**Administrative and Operational Manual**

**September 12, 2022**

The Patrol FTO Program consists of a minimum of 45 work days for newly sworn patrol officers and a minimum of 30 days for lateral/ prior police experience officers. The maximum time a trainee can remain in the Patrol FTO program is 90 work days.

The program consists of two distinct phases. The first phase is a minimum of 30 days for a rookie trainee and a minimum of 20 days for a lateral officer. At the end of this phase, and with approval of supervisory staff, the trainee will move into Phase 2 for the completion of their training. Performance is measured by exams, reports, task completion, and other methods as determined by the FTO Coordinator.

**3-639.3 PATROL FIELD TRAINING OFFICERS**

The selection of sworn officers to act as Patrol Field Training Officers (FTOs) will be closely monitored by the Patrol Shift Commanders. Officers must meet the following requirements:

- Have at least two years' experience (MPTSC requirement) as a police officer post-Academy;
- Have demonstrated a solid understanding of Agency policy and procedures, including criminal and procedural law;
- Have satisfactory performance evaluations for the last year;
- Have their immediate supervisor's recommendation;
- Have the recommendation of their shift commander;
- Be highly motivated and be a positive role model for the Agency;
- Be willing to be subject to transfer within the Patrol Division as the needs of the program require.

Patrol Officers selected to perform the duties of FTO will be constantly evaluated by their immediate supervisor. Performance which does not meet with the standards set forth in the program will result in the officer being removed from the program.

**3-640 CADET PROGRAM**

**3-640.1 DESCRIPTION**

The Charles County Sheriff's Office Cadet Program is designed to temporarily employ young adults seeking employment as police officers or correctional officers with the Charles County Sheriff's Office. Cadets are non-sworn Agency employees. No rank structure exists within the Cadet Program and all cadets are part-time employees serving at the will of the Sheriff.

Cadets require no training prior to commencing employment with the Agency; however, cadets experience on-the-job training to learn the duties of the specific assignments cadets receive throughout the Agency.

The Cadet Program is under the direct supervision of the Training Division. The cadets are periodically evaluated for efficiency and job performance. Successful cadets may be appointed as Police Recruits / Correctional Officers to the first Academy class for which they become eligible, after serving a minimum of one year as cadets.

**3-640.2 REQUIREMENTS**

Cadets must meet the same requirements as those of police officers, excluding the age requirement, and maintain those qualifications while in the Cadet Program. Failure to maintain these standards and qualifications while in the Cadet Program will result in dismissal from the program and the Agency. Cadets must be between the ages of 17 and 19 at the time of application. Applicants may not be appointed until they are 18 years of age and must be appointed before their twentieth birthday. Cadets may enter the Police or Corrections Academy at age 20 provided they will reach their 21<sup>st</sup> birthday before graduation.



**Administrative and Operational Manual**

**September 12, 2022**

A Cadet who becomes ineligible for the position of police officer or correctional officer during employment as a Cadet will be terminated.

**3-640.3 EDUCATION**

Cadets may be in their final year of high school to begin the application process, or hold a diploma from a recognized high school or possess a General Education Development certificate recognized by the Maryland State Board of Education.

They may be high school seniors who are at least 18 years old, planning to major in criminal justice or a related field, or be enrolled in college taking courses in criminal justice or a related field, maintaining a 2.5 grade point average.

**3-640.4 WORK ENVIRONMENT**

Cadets will work a maximum of 24 hours per week, with some exceptions. Work schedules and hours will vary and include shift work and weekends, but may be adjusted around college schedules and demands.

Cadets are non-sworn uniformed members of the Training Division; however, they may be assigned to other divisions as needed.

Cadets shall treat all Agency communications, information and business as confidential. Official information shall not be provided outside of the Agency except as provided elsewhere in this Manual. All report dissemination will originate from the Records Management Section.

Cadets shall not access any Agency computer for the purpose of using the information contained therein for other than official purposes. No information obtained from any Agency computer shall be divulged except as permitted by law and Agency policy.

**3-640.5 DUTIES, ROLE, AND SCOPE OF AUTHORITY**

Cadets are not sworn officers and are not given the power or authority to make arrests or take any law enforcement action whatsoever. Cadets shall not exercise any arrest or enforcement authority. Cadets shall not intentionally engage in activities that may require the powers given to sworn officers, such as the use of force or powers of arrest. This does not prohibit their ability to come to the aid of a citizen or another officer in need of assistance as would any other citizen or at the direction of a lawful order by a sworn officer.

Cadets will assist members of the Agency in accomplishing work objectives to include:

- Administrative duties;
- Performing duties of a Police Station Technician;
- Assisting Traffic Operations with various duties such as:
  - Commercial vehicle inspections;
  - School bus safety inspections;
  - Conducting safety seat inspections;
  - Crime prevention and Traffic Operations public education programs;
  - Staffing CCSO informational displays or booths;



## Administrative and Operational Manual

September 12, 2022

- Assisting with crowd control and traffic control at public events such as carnivals, fairs, fireworks displays, sporting events;
- Assisting with crowd control and traffic control at crime scenes, fires, traffic light outages, and other unusual occurrences;
- Working in the Charles County Detention Center providing assistance in areas that do not involve direct contact with the inmates of the Detention Center; and
- Any other related duties authorized by the Commander, Training Division and within the cadet's scope of authority.

Cadets may also be utilized as a resource for support services during emergencies and large scale special events in accordance with their scope and authority.

Cadets shall not be assigned to perform law enforcement related tasks which would require a sworn law enforcement officer without the direct supervision of a sworn member of the Agency. They will, from time to time, be assigned to assist sworn members of the Agency with their law enforcement related duties. In such instances, the sworn officer will provide the exact nature of the Cadet's duties, and the Cadet will be provided any necessary training to perform his assigned task. During this time, the Cadet shall remain under close supervision by the sworn member.

Cadets shall not be assigned or authorized to carry any weapons, lethal or non-lethal, at any time except during formal training by a certified firearms instructor.

Cadets shall not take any action that is contrary to, or interferes with, the duties of the members of the Agency.

### 3-640.6 OPERATION OF AGENCY VEHICLES

Cadets may operate Agency vehicles only if they are on duty, possess a valid operator's license, and are directed by a supervisor. Vehicles operated by a Cadet may be used for:

- Transportation to and from maintenance facilities;
- Administrative purposes;
- Transportation to and from an assignment location; and
- Special assignments.

Cadets will not use any vehicle to pursue another vehicle or respond to any situation with the emergency equipment activated.

Cadets may operate an emergency vehicle only if they are accompanied by a sworn officer or at the direction of a sworn supervisor.

### 3-640.7 TRAINING

Cadets provide services to support duties not requiring sworn officer status. Prior to any assignment, the Cadet will receive instructions and/or training appropriate to the duties anticipated. Often such training is conducted one-on-one, with an officer / employee assigned to perform such duties. Cadet training may vary from formal classroom training to on-the-job training.

### 3-640.8 AUTHORIZED UNIFORMS



**Administrative and Operational Manual**

**September 12, 2022**

In order to clearly distinguish cadets from sworn or correctional officers, cadets are authorized to wear uniforms only as described in Section 3-520 of this Manual.

Cadet patches shall be worn on all uniform items displaying the Agency shoulder patch. The Cadet patch shall be worn centered 1/4 inch below the Agency shoulder patch.

Cadets will wear a black baseball style cap with the cadet patch centered at the front of the cap. No other style of hat / cap is authorized to be worn with the cadet uniform. No Agency patch will be displayed on the cadet cap.

Cadets are issued a cadet badge which is in the general shape of a shield. The cadet badge is clearly different from the seven-point star issued to sworn officers. Cadets must carry their assigned cadet badges at all times while wearing their basic uniform. Cadets are strictly prohibited from carrying or displaying the cadet badge while off-duty.

The cadet uniform is to be worn by a Cadet only while in the performance of official duties. Cadets are prohibited from wearing any part of their uniform while not on duty, other than traveling to and from work.

**3-641 EXPLORER POST #1658**

The Charles County Sheriff's Office is the sponsoring Agency for Explorer Post #1658. The Post is a subsidiary of the Boy Scouts of America (BSA) organization. The Post is made up of young men and women ranging in age from 14 to 21 years old who have an interest in the law enforcement profession.

Explorers assigned to Post #1658 are volunteers and are in no way considered employees of the Charles County Sheriff's Office. Explorers must meet minimum standards and abide by the Constitution and By-Laws of the Post to remain in the Post.

The Post holds meetings bi-monthly for the purpose of conducting Post business, conducting training and activities related to the Post. The meetings are led by the Post officers and the Advisor/ Assistant Advisor(s). The Post accepts requests for community service through the Post Advisor who evaluates and approves such requests. The Post Advisor/ Assistant Advisor(s) will ensure each community service event is supervised by an adult or police officer, as appropriate for the event.

The overall operation of Explorer Post #1658 is overseen by the Commander, School Resources Section, Special Operations Division, who shall appoint members of the Agency to act as the Explorer Post Advisor and Assistant Explorer Post Advisor(s). The Advisor and Assistant Advisor(s) have the responsibility to oversee the daily operations of the Post.

**3-641.1 UNIFORMS**

The uniform worn by the Explorers and any equipment used by the Explorers shall be approved by the Commander, School Resources Section, Special Operations Division. The Agency will not provide uniforms to the Explorers and any uniform and equipment they have will be purchased at their expense. The uniform will be such that it cannot be mistaken for any uniform worn by sworn members of the Agency.

Uniforms and equipment will only be worn to meetings and on specific occasions as set forth by the Post Uniform Regulations and the Post Advisor.

**3-642 CHARLES COUNTY SHERIFF'S OFFICE AUXILIARY VOLUNTEER PROGRAM**

The purpose of the Charles County Sheriff's Office Auxiliary Volunteer program shall be to provide voluntary personnel capable of assisting the Charles County Sheriff's Office, under the authority of the Sheriff, when such augmentation is essential to public safety and welfare.

Auxiliary Volunteers are personnel who volunteer their services to assist the Agency in law enforcement-related

**Administrative and Operational Manual****September 12, 2022**

community service functions. Auxiliary Volunteers perform specific duties without any financial compensation from Charles County.

Auxiliary Volunteers are only permitted to perform specifically authorized duties. Auxiliary Volunteers are not sworn police personnel. They do not have arrest powers and will not be assigned to duties requiring sworn police officer status. They may not carry firearms, even if they are lawfully allowed to do so under authority granted outside this program. Unless specifically authorized by the Sheriff, they will not carry weapons of any type.

Auxiliary Volunteers serve at the pleasure of the Sheriff of Charles County and may be, at the Sheriff's discretion, terminated from the program at any time for any reason. They will be held to the same standards as Agency employees, adhering to the dictates of the Agency Administrative and Operational Manual. Additionally, the Sheriff may terminate the entire program at any time.

### **3-642.1 AUXILIARY VOLUNTEER QUALIFICATIONS**

Auxiliary Volunteer applications will be accepted through the Sheriff's Office's Administrative Services Division.

Auxiliary Volunteer applicants must meet the following basic requirements:

- must complete a Preliminary Application for Volunteer Work Programs Form #382;
- must be a minimum age of 21 years old;
- must be a United States citizen and reside in reasonable proximity to Charles County, as approved by the Commander of Special Operations;
- cannot have criminal convictions for any felony or serious misdemeanor offenses (i.e., serious crimes against persons, drug possession / sales, serious property crimes, etc.);
- must possess a valid Maryland Driver's License and have a good driving record;
- must be willing to provide a minimum of 8 volunteer service hours each month;
- must have a telephone;
- must be in good (age appropriate) physical condition as documented by a doctor's certificate;
- must submit to a background investigation and criminal history review; and
- must agree to submit to mandatory random drug and alcohol testing.

### **3-642.2 ORGANIZATION**

The Commander of Special Operations Division, Community Services Section shall oversee the daily planning, coordination, and operation of the Auxiliary Volunteer Program. The Commander shall have the authority to appoint a sworn police officer, the rank of Corporal through Lieutenant, to assist in administering the Program. This officer shall be designated as the Administrator of the Auxiliary Volunteer Program.

The Auxiliary Coordinator shall be a member of the Auxiliary program and appointed by the Commander. He will assist the Commander and Administrator in coordinating the Auxiliary Volunteer Program. The Auxiliary Coordinator, as assigned by the Commander / Administrator, may be called upon to:

- assist with the interviewing of Auxiliary Volunteer candidates;



## Administrative and Operational Manual

September 12, 2022

- assist in the implementation of an Auxiliary Volunteer recruitment / retention program;
- make administrative and operational decisions for the Auxiliary Volunteer Program during the absence of the Commander and Administrator; and
- accept a minimum of two assignments per month, alternating among all districts, and be available for emergency call-outs in the district in which he resides.

The Auxiliary Coordinator position and the Auxiliary Assistant Coordinator position will be signified on the Auxiliary Volunteer uniform utilizing approved collar brass.

These positions may be paid or unpaid, at the discretion of the Sheriff.

### 3-642.3 AUXILIARY VOLUNTEER SERVICE

Auxiliary Volunteers serve as an unpaid personnel resource in emergencies, large-scale special events and other various routine duties. Auxiliary Volunteers will not be intentionally used in any manner that could reasonably be expected to bring disrepute to the Sheriff's Office or place a Volunteer in unreasonable jeopardy. Whether called for service in emergency or other circumstances, Auxiliary Volunteers shall make every attempt to respond as requested when called to duty by the Sheriff, or designee.

Auxiliary Volunteers may be required to attend monthly meetings and training sessions. Auxiliary Volunteers shall notify the Commander or Administrator if they cannot attend these meetings.

Auxiliary Volunteers shall keep accurate records of their time worked in hourly increments (i.e., hours should be rounded up or down to whole hours). Volunteers are to fill in the Daily Activity Report Form #951 which shall be submitted to the Commander, Community Services by the last day of each month through the chain of command, to be maintained in a file. Duties and responsibilities may be expanded or reduced at any time, consistent with Agency policy and responsibilities.

Members of the Auxiliary Volunteer Program are permitted to hold paid positions with the Charles County Government. Paid hours cannot be claimed as volunteer hours; similarly, volunteer hours cannot be claimed as paid hours. Volunteer duties cannot be related to paid duties.

### 3-642.4 AUXILIARY VOLUNTEER TRAINING

Training will be conducted to introduce new Auxiliary Volunteers to tasks they will perform in an operational and support capacity. In-service training, consisting of classroom and/or practical-application instruction, will be conducted for veteran Auxiliary Volunteers at least once per annum. Training locations will be specified for each training session. On-the-job training will be conducted as appropriate.

Entry-level training will be conducted for Auxiliary Volunteer Candidates who meet minimum program eligibility requirements. The entry-level Academy program will consist of a minimum of the following courses of instruction for all volunteers:

- Orientation & Introduction to Communications;
- Agency Policies, Rules & Regulations;
- Uniform & Equipment Issuance, Wear & Care;
- Ethics;
- first aid, CPR / AED and first responder training; and
- Other, as deemed appropriate, which may or may not include report writing, civil liability, constitutional / criminal / motor vehicle traffic laws, handling and responding to incidents for service.

All Auxiliary Volunteers will be issued a copy of the Agency Administrative and Operational Manual, in electronic





**Administrative and Operational Manual**

**September 12, 2022**

and/or paper format, and will be expected to be familiar with and in compliance with the policies contained within, in the same manner as Agency employees.

Some volunteers may elect to apply for clerical details only, in which case they will receive training in office procedures and duties of a non-operational nature, as the assignment warrants.

Volunteers who apply to work primarily operational assignments will receive additional training in the following areas:

- Traffic Direction
- Court Testimony & Mock Trial
- Patrol Procedures
- Crime Prevention Displays / McGruff
- Radio Use and Codes
- Weapons Familiarization
- Defensive Driving
- Military Courtesy

In-service training is intended to provide continuous skill enhancement and ensure Auxiliary Volunteers remain current with law enforcement techniques and changes in the law. As such, in-service training will be required for veteran Auxiliary Volunteers at least once annually.

In-service training may consist of some or all of the following, based upon Agency employee training requirements:

- criminal law updates
- CPR / AED recertification
- OC spray (if applicable)
- mental health services
- hazardous materials
- sexual harassment
- cultural diversity
- homeland security issues
- non-lethal weapons training
- knowledge of County roads and locations
- blood borne pathogens

### **3-642.5 AUXILIARY RULES AND REGULATIONS**

An efficient, well-disciplined Auxiliary Volunteer program requires each Auxiliary Volunteer to understand and adhere to applicable rules, regulations, policies, and procedures while performing his duties. The public closely scrutinizes Auxiliary Volunteers actions, both in and out of uniform; this scrutiny arises from the Auxiliary Volunteer's association with a highly visible arm of local government. Misconduct or inefficiency not only creates a negative impression for individual members, it reflects poorly on the entire Sheriff's Office.

It is the policy of the Charles County Sheriff's Office to ensure all personnel maintain exemplary standards of personal integrity and ethical conduct in their relationship with other Agency members and the community. These rules are not intended to be all encompassing, nor are they intended to prevent the Agency from disciplining employees / volunteers for acts or omissions not specifically enumerated within them.

Auxiliary Volunteers who violate rules and regulations will be subject to disciplinary action and/or dismissal from the program.

Auxiliary Volunteers shall adhere to Agency rules, written directives, County personnel regulations, County administrative procedures, Executive Orders, County Code, and conform to all laws applicable to the general public.



**Administrative and Operational Manual**

**September 12, 2022**

No member of the Auxiliary Volunteer Program shall violate any federal, state, county or municipal Law. Auxiliary Volunteers are not vested or empowered with authority to make arrests.

Auxiliary Volunteers are not granted authority to possess, carry or use any firearm as members of the program. Auxiliary Volunteers may be issued certain non-lethal weapons under the authority of the Sheriff or a designee. Upon completion of an approved course of instruction, the Quartermaster will issue said weapons as standard equipment.

Auxiliary Volunteers may purchase and wear body armor at any time the Auxiliary Volunteer is likely to encounter members of the general public (i.e., Auxiliary on patrol, traffic control at parades, funerals, and crash / fire scenes etc.).

Auxiliary Volunteers performing traffic control shall wear an authorized / issued reflective vest or garment as their outermost garment. The vest shall be worn over the raincoat and/or winter jacket in inclement weather.

Auxiliary Volunteers shall not respond to radio calls for service and render service unless directed to do so by the Commander, Administrator, or Communications. Only those Auxiliary Volunteers requested will respond to an incident scene. This directive does not preclude Auxiliary Volunteers from stopping to render aid in an emergency situation where the Auxiliary is the first official on the scene. In these instances, the Auxiliary Volunteer should immediately summon assistance and follow directions from responding police / fire personnel.

Auxiliary Volunteers shall participate in ceremonial events when directed; these occasions may include, but are not limited to, parades, installation of officials, honors, dedications, memorial services and funerals. The Uniform of the Day will be dictated by and at the discretion of the Commander / Administrator or a designee.

The Auxiliary Volunteer program shall be non-partisan; members will not take part in any type of political activity while acting in the name, or in the capacity of, the Auxiliary Volunteer Program.

Disciplinary issues and complaints of any violations of laws or Agency policies will be handled in the same manner as those handled for civilian employees of the Agency.

**3-642.6 PERSONAL APPEARANCE STANDARDS**

Auxiliary Volunteers, the same as Agency employees, shall present an appearance which inspires public confidence in their professionalism. In this regard, auxiliaries will comply with Agency grooming regulations in this Manual. The Commander of Community Services may impose additional appearance standards so long as the standards remain consistent with Charles County Sheriff's Office policies and directives.

Personnel inspections will be periodically completed by the Commander / Administrator or a designee to ensure personnel conform to uniform requirements.

**3-642.7 DUTIES AND RESPONSIBILITIES**

Auxiliary Volunteers may be assigned to work in a variety of duties within the Sheriff's Office, both administrative and operational. Locations for administrative assignments will depend on the Auxiliary Volunteer's skills, interests and Agency need. Formal or on-the-job training will be provided prior to assignments as necessary. Auxiliary Volunteers are required to perform at least 8 hours of approved or assigned duty each month. Auxiliary Volunteers will perform at least two assignments each month when assignments are available.

Administrative assignments may include:

- Agency tours;
- assignments in the Communications Section, Identification Section, Central Records Section, Crime Prevention Unit and any other area where clerical and volunteer office support can supplement police



## Administrative and Operational Manual

September 12, 2022

resources.

Operational assignments may include:

- traffic control;
- participation in funeral details;
- assisting with security surveys;
- assisting with crime prevention displays, serving in costume as McGruff the Crime Dog;
- assisting with Executive Protection details, parades, fairs, carnivals, disaster sites, and other activities of a non-violent nature.

### 3-642.7.1 OPERATIONAL DUTIES

Auxiliary Volunteers assigned to patrol operations are intended, unless otherwise directed by a patrol supervisor, to provide additional personnel for observation of criminal activities, traffic hazards, other unsafe conditions, and unusual activity in business and residential areas. Auxiliary Volunteers shall notify Police Communications upon becoming aware of an incident requiring additional assistance. Auxiliary Volunteers shall document extraordinary patrol activities on their log and on a Commanders' Information Report.

Auxiliary Volunteers shall advise the Communications Section of their duty status at the beginning and end of their tour of duty (10-41 & 10-42). Auxiliary Volunteers shall inform the Communications Section when they arrive at and depart from an incident scene. Auxiliary Volunteers must remain attentive to radio calls during their tour of duty and promptly respond when called on the radio. Auxiliary Volunteers should use appropriate "ten codes" when communicating and remain frugal in using the police radio. The call sign prefix for Auxiliary Volunteers shall be "Auxiliary" (Example: "Auxiliary 7100").

Auxiliary Volunteers shall be scheduled for Auxiliary Patrols by the Commander / Administrator at least 48 hours prior to the patrol. They shall report for duty in proper uniform with appropriate equipment for patrol (i.e., approved flashlight, traffic vest, raincoat, etc.). The Auxiliary Volunteer shall report to the shift supervisor and should attend the shift lineup. The Auxiliary Volunteer shall use an Auxiliary vehicle when possible.

In the event of civil unrest, labor strikes or similar incidents, Auxiliary Volunteers will not be requested for service, nor assigned duties, which could reasonably be expected to place the Auxiliary Volunteer in physical danger or draw the Auxiliary Volunteer into the controversy. Auxiliary Volunteers may be utilized for peripheral duties, i.e., establishing an outer perimeter by traffic control, booking prisoners, transporting supplies, etc.

### 3-642.8 UNIFORMS AND EQUIPMENT

With approval from the Commander, Special Operations, the Quartermaster will issue all Auxiliary Volunteer uniforms and equipment. Any items of equipment (flashlights, etc.) the Auxiliary Volunteer may want to carry in addition to what is issued must be approved by the Commander / Administrator. The Auxiliary Volunteer uniform will clearly distinguish Auxiliary Volunteers from sworn police officers. The Auxiliary Uniform will be worn in a manner consistent with current Agency policy. Each Auxiliary Volunteer shall be individually responsible for care and cleaning of his issued Charles County Auxiliary Volunteer Uniform. All Auxiliary Volunteers shall be responsible for equipment issued to them. If any equipment is lost or damaged, the Auxiliary Volunteer shall make a complete report and submit it to the Commander / Administrator as soon as practical.

Auxiliary Volunteer uniforms are to be worn only for official Auxiliary Volunteer business. No Auxiliary Volunteer shall wear the uniform, whether in whole or in part, while not in an official capacity. Auxiliary Volunteers shall not exchange, lend, borrow, modify or sell any part of the uniform.

The uniform of the day will be prescribed through the Office of the Sheriff. Weather conditions may vary widely while Auxiliary Volunteers are on duty; members shall report fully prepared for such changes by carrying jackets, raincoats, etc. When a jacket is worn with approved summer uniform, a tie need not be worn.

All Auxiliary Volunteers working on the same assignment must be dressed in the same attire. Whether the



**Administrative and Operational Manual**

**September 12, 2022**

assignment is a parade, traffic control, or some other function, every Auxiliary Volunteer must be in complete uniform when working any prescheduled assignment. The complete uniform includes the issued hat unless directed otherwise by competent authority.

Each Auxiliary Volunteer will be issued an Agency identification card. The ID card will be shown upon request and will display the Auxiliary Volunteer's name, ID number, and photograph. If exigent circumstances (emergency details) arise to prevent the wearing of the approved uniform, non-uniformed Auxiliary Volunteers will display their Agency identification on their outermost garment while on duty. Auxiliary Volunteers will identify themselves to any citizen requesting identification by supplying their full name and identification number.

**3-642.8.1 AUXILIARY VOLUNTEER RADIOS**

The Communications Section shall be responsible for the issuance of the Auxiliary Program Agency radios. Police radio use is only permitted for official Sheriff's Office business and shall be in conformance with usage policy elsewhere in the AOM. Any other unofficial use of the police radio is strictly prohibited. Off-Duty use of the Sheriff's Office radio by Auxiliary Volunteers will be limited to emergency situations. Violations of these provisions will result in disciplinary action and/or separation from the program. Auxiliary Volunteers will be monetarily responsible for intentional damage, negligent damage or equipment loss.

**3-642.8.2 AUXILIARY VOLUNTEER VEHICLES**

Auxiliary Volunteer vehicles are provided to meet organizational and operational goals of the Auxiliary Volunteer Program. The Special Operations Division, Community Services Section shall be responsible for the custody and control of Auxiliary Volunteer vehicles. Fleet Management will be responsible for the care and maintenance of the vehicles. This responsibility may include four-wheel-drive and special purpose vehicles. The Special Operations Division shall be responsible for informing Fleet Management of maintenance needs for these vehicles. Any Auxiliary Volunteer who is authorized to operate these vehicles shall do so in accordance with the Rules and Regulations set forth in this policy and elsewhere in the Charles County Sheriff's Office AOM. All drivers must operate Auxiliary vehicles in accordance with Maryland Motor Vehicle laws.

Auxiliary Volunteer vehicles will only be used on authorized assignments. The vehicles may be prescheduled for assignments, but emergency details will supersede any prescheduled assignments. In the event that an auxiliary vehicle is not available, a police pool vehicle may be utilized with approval of the Commander, Special Operations or his designee.

No Auxiliary Volunteer shall operate an Agency vehicle unless that Auxiliary Volunteer possesses a valid Maryland Driver's License. All Auxiliary Volunteers are required to complete a Defensive Driving Course conducted by Charles County Sheriff's Office prior to completing 6 months of service in the program.

Auxiliary Volunteers have a duty to operate Agency vehicles in a safe and legal manner. Any Auxiliary Volunteer who becomes involved in a preventable crash through negligence, as determined by the Collision Review Board, may be charged with negligence. The Collision Review Board will refer preventable crash findings to the Commander, Special Operations for disciplinary action.

Auxiliary Volunteers will not operate Agency vehicles with emergency equipment (i.e., lights, siren) activated to facilitate a more rapid response to any assignment. There shall be no exceptions to this policy. Any Auxiliary Volunteer discovered performing a priority response is subject to immediate dismissal from the Auxiliary Volunteer program.

No Auxiliary Volunteer shall engage, or attempt to engage, in a vehicular pursuit in any fashion. No Auxiliary Volunteer shall be permitted to engage, or attempt to engage, in a vehicular traffic stop. Any Auxiliary Volunteer who violates this provision is subject to immediate dismissal from the Auxiliary Volunteer program.

Operators shall not permit the engine of the vehicle they are operating to be left running while the vehicle is



**Administrative and Operational Manual**

**September 12, 2022**

unattended. The vehicle shall be secured (i.e., ignition locked and door locked) whenever the vehicle is left unattended. Auxiliary Volunteers will not utilize Agency vehicles to jump-start any vehicles.

Every Auxiliary Volunteer assigned to operate an Auxiliary or Agency vehicle shall be held accountable for the proper use and care of the vehicle and all accessories, equipment and tools assigned to the vehicle. Insofar as Auxiliary Volunteer vehicles are shared, each Auxiliary Volunteer shall be held jointly responsible for proper vehicle use, servicing and inspection. Each Auxiliary Volunteer assigned to operate an Agency vehicle shall carefully inspect the vehicle at the beginning of each tour of duty to assure that the vehicle is in operating condition and properly equipped. The inspection shall include a check of the following:

- gasoline, oil, water, battery and tires;
- brakes, lights, windshield wipers and warning devices;
- equipment (its presence and condition);
- damage (body, seats, etc.); and
- interior and exterior vehicle cleanliness and/or damage.

Any defects, damage or loss reported after the vehicle has been inspected and placed in service shall be considered to have occurred during the reporting Auxiliary Volunteer's tour of duty. It is essential all Auxiliary Volunteers carefully inspect Auxiliary vehicles for damage, defect or absence of equipment before placing the vehicle in service.

If a mechanical defect occurs while a vehicle is being operated, the driver shall, as soon as possible, contact the on-duty supervisor for instructions. If a vehicle's condition renders it unsafe for transit, the vehicle will not be moved. The Auxiliary shall notify a sworn supervisor and the Police Communications Section. Inoperable or hazardous vehicles shall be towed to a Charles County Sheriff's Office Authorized Repair Facility for repairs.

Damaged bumpers, fenders, glass, etc., which do not affect the efficient and safe operation of the vehicle, shall be reported as in other cases. In these instances, the vehicle shall be kept in service until scheduled for repairs. Volunteers shall complete and turn in to the Commander, Community Services Section, the Monthly Motor Vehicle Report Form #76.

### **3-642.9 AGENCY VEHICLE COLLISIONS**

When an Auxiliary Volunteer is involved in any collision in an Agency vehicle, regardless of whether or not the collision involves property damage or personal injury, the following procedures shall apply:

- the Auxiliary Volunteer will immediately notify Communications and request a supervisor respond;
- an on-duty sworn supervisor of the District where the accident occurred will respond to the accident scene and will assume responsibility for the accident investigation in accordance with the procedures listed in the Charles County Sheriff's Office AOM;
- the Auxiliary Volunteer shall follow the police supervisor's and/or the investigating officer's directions, answer all their questions and complete all requested paper work; and
- if possible and practical, the Auxiliary Volunteer shall notify the Commander, Special Operations / Administrator, Commander, Community Services Section or designee of his involvement in an Agency collision.

### **3-642.10 AUXILIARY RIDE-ALONG PROGRAM**

The Ride-Along Program is designed to allow Auxiliary Volunteers to accompany police officers during the officer's tour of duty. The Auxiliary Volunteer will serve as an observer, rendering assistance only when directed by the uniformed officer. This program is the responsibility of the Patrol operations commanders, who will administer the program, but application procedures in 3-107.2 will be followed.

**Administrative and Operational Manual****September 12, 2022**

The Ride-Along Program must be administered uniformly in both Patrol Divisions; it is essential all Auxiliary Volunteers adhere to established procedures. Auxiliary Volunteers are eligible to Ride-Along twice in one month after achieving 8 hours of service and two regular assignments. An Auxiliary Volunteer must comply with the following to qualify for participation in the Ride-Along program:

- must have performed the minimum of 8 hours of service for the previous month, consisting of at least two assignments;
- must have an up-to-date personnel file; and
- must submit a request to the Community Services Section Lieutenant at least two weeks prior to the Ride-Along date requested;
- must have completed and have approved the Application Form #38.1, General Release Form #38A, Authorization Form #38.1B, and the Guidelines for Ride-Along Participants Form #38.1A.

The Lieutenant will determine if the requesting Auxiliary Volunteer is eligible to ride. If eligible, the request will be forwarded to the appropriate police station technicians to complete the process. The Auxiliary Volunteer will be notified of the disposition of his request. The number of Auxiliary Volunteers assigned to Ride-Along within a given district will be at the discretion of the shift commanders.

The uniform of the day will be worn during the Ride-Along unless otherwise prescribed. No firearms or unauthorized weapons/ equipment will be carried. Approved flashlights are permitted and encouraged during the hours of darkness.

The Auxiliary Volunteer will report to the designated shift supervisor at least fifteen (15) minutes before the designated Ride-Along start time. The Auxiliary Volunteer will generally ride a minimum of four (4) hours, but no longer than eight (8) hours during a single Ride-Along. The four (4) hour minimum will constitute a single / full ride along.

Auxiliary Volunteers will follow all lawful commands, orders and/or directions given to him by any police officer. Auxiliary Volunteers are not to be intentionally placed in jeopardy and/or in dangerous situations. However, Auxiliary Volunteers must realize certain hazards are always present.

Auxiliary Volunteers shall refrain from physical contact with suspects / offenders / citizens when possible. Any time an Auxiliary Volunteer uses any physical force, regardless of the degree, or becomes involved in any incident that may later bring repercussions (i.e., court, citizen complaint, etc.) the Auxiliary Volunteer shall submit a written report or inter-office correspondence to the Commander within 24 hours of the incident. The report shall include all pertinent facts of the incident, including the police case number.

Ride-Along time will not be considered time served against the 8-hour minimum. However, Ride-Along times will be recorded on monthly reporting sheets. If other Auxiliary Volunteer assignments interrupt the Ride-Along for a minimum of one (1) hour, time spent working the assignment will be recorded in the normal manner.

**3-642.11 AUXILIARY VOLUNTEER INJURIES**

Any Charles County Auxiliary Volunteer injured while on duty, or who becomes physically ill or otherwise incapacitated, shall report the injury or illness to a sworn supervisor as soon as possible. The supervisor will ensure a Report of Injury or Illness Form #227 is completed and that the Volunteer receives prompt medical attention. Copies of the Report of Injury or Illness form and any related police incident reports shall be forwarded to the Commander, Special Operations, Community Services Section, who will in turn submit them to the Administrative Services Division. If possible and practical, the injured and/or incapacitated Auxiliary Volunteer will also personally notify the Commander or Administrator. The Commander will conduct follow-up to ensure required medical / Workers' Compensation paperwork is submitted to and received by Human Resources. Any follow-up shall be as



**Administrative and Operational Manual**

**September 12, 2022**

outlined in Chapter 6-202 of the AOM.

Auxiliary Volunteers designated for light-duty will have restrictions on duties they may perform. Eligible light-duty tasks will be determined on a case-by-case basis; consideration will be given to the specific medical / personal needs of the Auxiliary Volunteer and the Agency.

**3-645 STUDENT INTERN PROGRAM**

The Charles County Sheriff's Office recognizes that a close working relationship with the community is imperative for effective operation. This includes working with local colleges, universities, and high schools in the development of a student intern program. The student intern program provides students with the opportunity to observe and participate in designated activities within the Agency. In addition, the Agency can observe potential police applicants in action. The focus of the program shall be to offer the students a variety of exposures within the Agency.

This section establishes program responsibility, eligibility, and operational procedures for the Student Intern Program.

**3-645.1 PROGRAM RESPONSIBILITY**

The responsibility for this program is assigned to the Commander, Administrative Services Division. The Pre-Employment / Recruitment Unit Supervisor will be responsible for coordinating with local colleges and universities, interviewing prospective interns, evaluating intern eligibility, coordinating necessary form completion, intern placement, and program evaluation.

**3-645.2 PROGRAM ELIGIBILITY**

Candidates shall meet the following requirements to be eligible to participate in the program:

- Currently enrolled as a Maryland high school Junior or Senior student, or a Maryland college/ university student or Maryland resident enrolled in an out-of-state college/ university. If under the age of 18 the student must have parent/ guardian written consent.
- Have the approval of a faculty advisor;
- Successful completion of a background investigation and oral interview conducted by the Pre-Employment/ Recruitment Unit Supervisor;
- Completion of Student Intern Program Application, Liability Waiver, and Student Intern Work Agreement.

**3-645.3 OPERATIONAL PROCEDURES**

Upon successful completion of the interview, the background investigation, and all necessary forms, the student intern will be given a tour of Headquarters for familiarization purposes.

The Pre-Employment/ Recruitment Unit Supervisor, Administrative Services Division, will coordinate the placement of interns within the Agency based on requests received from the various divisions. Efforts will be made to give the intern as many diverse assignments as possible. Following deployment, commanders shall exercise normal managerial authority over interns and shall assign either a sworn or a civilian employee to monitor the intern's progress.

Interns, who will serve for any length of time to make it feasible, will be issued a photo I.D. card identifying them as a student intern.



Administrative and Operational Manual

September 12, 2022

An intern may be removed from the program when circumstances warrant such action for the benefit of the Agency. Recommendations for removal shall be directed to the Commander, Administrative Services Division.

### 3-646 TRAINING RECORD

The Commander, Training Division will establish and maintain records of schools, seminars, conferences, and training programs attended by Agency personnel. The Commander, Training Division shall see that a copy of each training record for individual employees is maintained within the employee's training file.

#### 3-646.1 REQUEST FOR TRAINING

The procedures for requesting training are as follows:

- The Request for Training Form #181 will be filled out in full for all requested training, excluding in service training for civilians, correctional and sworn personnel and in-house, no cost, training programs. The form should include a justification for attending the training.
- Any fliers or further information on the training will be attached to the Request for Training. Incomplete Requests for Training will be sent back to the originating division commander for further documentation.
- Any costs associated with the training should be included on the form 181. Examples: air travel, lodging, rental vehicles, or per diem. These can be basic estimates determined through internet search. The Training Specialist will research the final cost once the Request for Training is received with approval signature by an Assistant Sheriff.
- If lodging is needed the night before the training, it should be noted on the Request for Training.
- The completed Request for Training will be forwarded up the chain of command to the appropriate Assistant Sheriff for approval. Requests that pertain to outside collateral duty related training (EST, Security Response Vessel Function, Crisis Negotiations, etc.) will be approved by the employee's direct chain of command. Upon approval, the employee's division commander will verify the training is approved through the Commander of the affected collateral duty assignment prior to forwarding to the Assistant Sheriff for final approval.
- All no cost training requests for programs presented outside of the Agency need only be approved by a division commander. All other training requests with costs associated are to be forwarded to the appropriate Assistant Sheriff for approval.
- In-house, no cost, training programs will be requested through the use of the on-line training request form located under the "Reports" tab on the Agency intranet. Supervisory approval to attend is required before completing the form.
- If a request is denied after going through the chain of command, the appropriate supervisor is to be notified and he is to advise the requesting party.
- All denied Requests for Training should still be forwarded to the Training Division for documentation purposes. An electronic file of the denied training requests will be maintained in the Training Division shared drive. The original denied paperwork will be returned to the originating division commander.
- If anyone in the chain of command is not available, please mark "unavailable" in that slot on the Request for Training and continue to forward the documents to avoid any undue delays in the approval process of the training.





**Administrative and Operational Manual**

**September 12, 2022**

The Commander, Training Division will coordinate with the Accounting Section to obtain the necessary funds.

All requests for training should be made sixty (60) days in advance when possible to allow for processing and disbursement of pre-paid expenses.

**3-646.2 TRAINING ASSESSMENT PROCEDURES**

Employees who conduct, participate in, or attend seminars, schools, conferences, and programs must complete the Report of Training Form #182 and forward through their respective chains of command, to the Commander, Training Division, within five (5) days after completion of training. A copy of any certificate awarded will be attached to the Form #182. This report will become a permanent part of the employee's training and personnel files.

**3-646.3 REPORT OF EXPENSES**

When Agency funds are spent with regard to training, a final accounting will be made to the Accounting Section at the completion of training. The Travel Expense Report Form #183 shall be used for this accounting. The Form #183 shall be submitted along with receipts for all expenses, except meals paid by per diem unless meal receipts are required by a special funding source, even if no out-of-pocket expenses were incurred. This form shall be submitted within five (5) days after the completion of training. The Travel Expense Report Instructions, Form #183a (printed on the reverse of Form #183) shall be complied with in the completion of Form #183. Additionally, the rules explained in the following sections shall govern the character and amount of expenses which may be reported. Only those allowed expenses, which are the direct result of the business purpose for which the travel is approved, will be allowed.

**3-646.3.1 TRANSPORTATION**

All travel shall be by the most direct route reasonably available. Side trips and detours for personal reasons are not allowed and will not be reimbursed. The most economical mode of transportation is the preferred method of travel. All factors shall be considered in deciding the most economical. For example, if the choices consisted of traveling by air or by car, the car trip would include the computed cost of the vehicle mileage, plus the meals in transit, plus the lodging if the trip required an overnight stop, plus the cost of any overtime hours spent driving, plus tolls, and so forth.

In most cases involving a trip by automobile, a Sheriff's Office vehicle shall be used. Civilian employees attending training classes should contact the Commander, Property Management to see if a suitable pool vehicle is available for their use. If no vehicle is available, an alternate method may be used. If the employee has a marked vehicle which would be inappropriate for the trip and/or no suitable pool vehicle is available for the employee's use, the employee may use a personal vehicle. The current standard mileage allowance will be reimbursed for personal vehicle use in an approved business capacity. The Training Division may be contacted for the current standard mileage allowance amount.

When public transportation is the preferred method of travel, the actual fare for the transportation shall be reimbursed. The ticket receipt or coupon is the proof of the cost of the transportation, not a charge receipt. The most economical class of travel shall be used.

Other miscellaneous transportation expenses, when incurred during business travel, which will be reimbursed include: porter or bellman fees at one dollar per bag, bus fares, street car fares, subway fares, parking fees and taxi/ ridesharing platform fares.

**3-646.3.2 LODGING**

Lodging may be provided to employees who are required to attend a business function which is more than two hours from their primary work location. This applies if the employee will work a full business day at the location of



## Administrative and Operational Manual

September 12, 2022

the function, and it is impractical, because of the time required to travel to and from the function in the same day. It will, in most cases, be considered impractical, if any expenses incurred (overtime and meals, if applicable) by traveling during non-work hours, would be greater than the expense of lodging and meals incurred by an overnight stay. In any case where the employee's workday would be extended beyond a period of fourteen (14) hours, including attending the function and the travel to and from the function, an overnight stay is presumed reasonable.

**NOTE:** The Agency is not able to get Federal government published hotel rates in most cases. Employees need to request either a government rate or special conference rate when making reservations.

Training will make reservations at a cost within published per diem rates. If an employee opts for accommodations in excess of the per diem rate, he will be responsible for any amount in excess, unless a prior approval has been granted because the function attended is held in the place of lodging, and it would be impractical or more expensive to stay elsewhere when all expenses related to that stay are considered.

All lodging receipts shall be itemized daily and only allowed business expenses in addition to the room rate shall be reimbursed. Such allowed items might include business telephone calls and laundry or cleaning expenses on extended stays. Such expenses as movie or television rental and room bar bills will not be reimbursed. If an employee travels with a family member who stays in the same room, any added expenses incurred as a result are the employee's responsibility and will not be reimbursed. Receipts shall not show non-allowable expenses.

### 3-646.3.3 MEAL EXPENSE REIMBURSEMENT

While on overnight travel, employees shall be eligible for meal expenses. Eligibility for a given meal is dependent upon the following circumstances:

- On the first day of travel with an overnight stay, the employee's lunch and dinner are eligible for reimbursement, and breakfast is eligible if the employee was required to leave home more than two hours sooner than required by the employee's normal commute to work. On the last day of travel connected with an overnight stay, the employee is reimbursed for breakfast and lunch. Reimbursement for dinner will be paid only if the employee returns home two hours after his normal commute time.
- If an employee is required to work at a location that is more than two hours from his normal work location, the employee shall be eligible for a before and/or after work meal. If in accordance with this policy, an employee is eligible for meal reimbursement for breakfast and/or dinner, the employee is also eligible for lunch reimbursement.
- When training does not require an overnight stay and does not meet the standards as established for per diem, employees will not be eligible for meal expenses. On the rare occasion when training meets the established standard for per diem but the employee elects to commute, he will be eligible for meal expenses. When these circumstances occur, no per diem meals will be paid in advance. The meal expenses will be reimbursed up to the allowable meal per diem after receipts are submitted with the Travel Expense Report Form #183. This saves the Agency on the number of check requests processed.

In an effort to standardize travel distances to comply with the two hour time frame, the Agency will use a recognized mapping website or application which is easily accessible through the Internet.

All meal pre-payments and reimbursements are based upon the current annual rates as published in the U.S. General Services Administration (GSA) website at [www.gsa.gov/perdiem](http://www.gsa.gov/perdiem). Daily rates are listed for particular cities or if not listed, there is a rate which applies to all other places in the Continental United States which will be used. Individual meal payments are determined by calculating 20% of the daily allowance for breakfast, 25% of the daily allowance for lunch and 55% of the daily allowance for dinner. Meal receipts are required if per diem has not been pre-paid to the employee. If receipts are required for reimbursement, only that amount meeting the per diem rates listed on the GSA website will be reimbursed. The employee should contact the Training Division for any questions in this matter.

**Administrative and Operational Manual****September 12, 2022**

No reimbursement will be made for the cost of alcoholic beverages. If the cost of meals is part of a duly authorized flat rate per diem or part of a maximum rate of reimbursement, the limitations set forth above shall not apply (for example, when personnel attend out-service training that is several months in duration such as Northwestern University or the FBI National Academy). When an official or employee is attending a meeting, seminar, or convention where a meal is part of the program and the employee must pay for the meal with his own money, the expense of such a meal will be reimbursed.

**3-646.3.4 MISCELLANEOUS ALLOWABLE EXPENSES**

Telephone and postage charges incurred in the performance of official duties are reimbursable. Registration and tuition fees for approved courses are reimbursable. The costs of supplies needed for courses, seminars, and conferences are reimbursable with receipts. When a training period exceeds one week, the cost of laundry, cleaning, and pressing may be allowed.

**3-646.4 CIVILIAN TRAINING**

Certain positions within the Charles County Sheriff's Office require in-service training as an essential function of those positions. In addition, civilian employees are encouraged to attend position-related seminars and training to supplement and encourage growth within the Agency.

The following civilian positions require completion of the CN1 (NCIC Logon Certification) Course administered by CJIS (Criminal Justice Information System) before being authorized to access confidential information involving state, national, and local agencies:

- Records Management personnel;
- Police Station Technician I, II;
- Police Communications Officer I, II, Supervisor;
- Warrant Specialist I, II;
- Firearms Tracking Specialist;
- Central processing personnel;
- Civil Process Server Specialist I, II, Supervisor;
- Child Support Enforcement Coordinator;
- Civil Specialist I, II;
- Latent Print Specialists.

ITD personnel must obtain the appropriate access level for their position.

Records Technicians and Central processing personnel are required to attend National Incident-Based Reporting System (NIBRS) training.

The Victim Services Coordinator is required to attend the Maryland State Board of Victim Services pre-certification conference.

When a civilian employee of the Agency is promoted or transferred within the Agency, that employee will receive either formal training if required, or on-the-job training by personnel qualified in the position being filled by the

**Administrative and Operational Manual****September 12, 2022**

employee. This training will either take place prior to the promotion or transfer or within the first year of the employee filling the new position.

### **3-646.5 POSITIONS REQUIRING SPECIALIZED TRAINING**

There are several positions throughout the Agency which have been identified as requiring some degree of specialized training. Each employee shall receive initial training by either attending a training course to develop skills in the particular specialization or by receiving instructions and on-the-job training. This development is continuously enhanced by on-the-job training and supervision by experienced personnel as well as additional training and seminars as approved.

The following is a list of the Agency identified positions requiring some degree of specialized training:

- Traffic Operations
- School Resource Officers/ D.A.R.E. Officers
- Electronic Fingerprinting Technicians
- Emergency Services Team Members
- Crisis Negotiators
- Forensic Science Technicians
- Truth Verification Examiners
- Drug Recognition Experts
- Intoximeter Operators
- Unmanned Aerial System (UAS) Operators
- Security Response Vessel Operators
- Motorcycle Operators
- Radar / Laser Operators
- Crime Scene Processors
- Field Training Officers
- Crisis Intervention Team Members
- MPTSC Certified Trainers
- Academy Instructors
- Firearms Instructors
- K-9 Handlers / Trainers
- Comfort K-9 Handlers
- Search Managers
- Special Events Response Team Members
- ATV/UTV Operators
- Community Policing Officers
- Crime Prevention Officers
- Forensic Chemist
- Latent Print Specialists

Additional positions may require some degree of specialized training as Agency policy, or legal requirements, change.

### **3-646.6 REMEDIAL TRAINING**

Remedial training is defined as personalized training used to correct a specific deficiency which may have been identified through:

- testing;



**Administrative and Operational Manual**

**September 12, 2022**

- evaluation by a supervisor or FTO during training;
- evaluation by a supervisor during routine job performance;
- employee performance evaluations;
- the disciplinary process; or
- employee requests.

The goal of remedial training is always to correct an employee's deficiencies in basic skills, knowledge, and abilities required to perform his job assignments. When it is determined that an employee should receive remedial training, it may be provided:

- through Agency in-service training;
- by re-assignment to the Field Training Program; or
- by enrollment in a course of instruction given by another agency, school, or university as deemed necessary.

Requests for remedial training shall be made by memorandum along with a Remedial Training Worksheet Form #775 and any supporting documentation. The memorandum will outline the deficiency in the employee's performance and include:

- a recommendation for training to correct the deficiency; and
- any other corrective action that may have already been taken.

The Commander, Training Division will review all approved requests for remedial training and make arrangements for the needed training. Once approved, remedial training must be completed within 30 days.

Upon completion of remedial training the employee will submit a Report of Training Form #182 through the chain of command to the Training Section. In addition, the employee shall be evaluated by his supervisor to determine the effectiveness of such training or if further training may be required. Results of this evaluation will be in memorandum form and will be forwarded through the chain of command to the Commander, Training Division with a recommendation for further action, if required. Unsatisfactory completion or non-participation in remedial training may be cause for disciplinary action.

### **3-647 CRITICAL INCIDENT INVESTIGATION TRAINING**

All officers shall receive awareness training regarding the investigation of critical incidents, including officer-involved shootings and other police actions leading to death or serious bodily injury, while they are assigned to the Southern Maryland Criminal Justice Academy.

Officers assigned to positions within the Criminal Investigations Division and the Office of Professional Responsibility who are responsible for the criminal and administrative investigation of such critical incidents shall receive additional training on the investigative process following their transfer into those positions.

All additional personnel potentially impacted by a critical incident or police action death investigation will receive awareness training periodically.



Administrative and Operational Manual

September 12, 2022

### 3-650 EMPLOYEE PERFORMANCE EVALUATION SYSTEM

There are established performance evaluation systems within the Charles County Sheriff's Office. These systems are designed to provide every employee and the Agency with an objective evaluation of the employee's performance of the essential functions of their position. A specific system has been developed for evaluating members of each segment of the Agency: police, corrections and civilian.

Performance evaluations serve the following purposes:

- To facilitate supervisors in identifying issues of concern and enhancing overall job performance;
- To encourage supervisors to identify issues of concern, put forth new ideas, and assist in goal setting for officers and the Agency;
- To facilitate and encourage frequent and open communication between supervisors and employees regarding job expectations, job performance, personal goal setting, and achievement;
- To provide a mechanism to review the period of evaluation and to discuss both positive and negative aspects of job performance as well as performance improvement plans if necessary; and
- To allow for the supervisor and the employee to discuss upward mobility, lateral movement, and/or identify training needs.

#### 3-650.1 DEFINITIONS

**Formal Entry-Level Training:** includes the Academy or Comparative Compliance Training and Field Training Program (FTO).

**Rater:** The person completing the performance evaluation form is the Rater. The Rater should be the immediate supervisor of the employee being evaluated.

**Reviewer:** The immediate supervisor of the Rater.

#### 3-650.2 GENERAL PROCEDURES

All employees shall receive a performance evaluation at least annually. All entrance level probationary employees shall receive quarterly evaluations. Civilians as well as non-commissioned sworn police and correctional officers shall receive an evaluation specific to their assignment. All civilian deputy directors, directors as well as commissioned sworn police and commissioned correctional officers shall receive a management level evaluation.

A candid performance evaluation requires continuous observation, analysis of employee's actions, first-hand knowledge of the employee and the employee's work habits, and accuracy in completing the evaluation. It is not a static activity and a true evaluation of an employee must be viewed as a continuous process with frequent communication and feedback between the supervisor and the employee. The review process should stimulate communication and interaction between the supervisor and employee.

The Rater may provide written comments in all applicable comment sections on the evaluation form. If additional space is needed, the Rater may attach a continuation page to the evaluation form.

Any disciplinary actions against the employee during the rating period shall be documented in the performance evaluation. Information contained in positive and negative conference forms received by the employee during the



## Administrative and Operational Manual

September 12, 2022

rating period may be incorporated into the performance evaluation and copies of conference forms may be attached as supporting documentation.

Completed and signed performance evaluations become a permanent part of the employee's personnel file.

### 3-650.3 REQUIRED RATER TRAINING

Training for raters will be conducted as needed through the Training Division. Any employee assigned to supervise and evaluate an employee will be required to attend training within thirty days of being assigned as a supervisor. The Commander, Training Division will coordinate with the Deputy Director, Human Resources Section to identify and schedule training for new supervisors. Supervisors will be rated on their ability to rate employees fairly, accurately, and according to the procedures outlined in this Manual.

### 3-650.4 CORRECTIONAL OFFICER PERFORMANCE EVALUATION SYSTEM

A performance evaluation within the context of the Correctional Officer Performance Evaluation System is an objective, structured evaluation of an employee's performance, for a specified period, of the essential functions which make up the employee's position description. The measurement of the employee's performance is gauged against established standards, as defined in this section.

The Correctional Officer Performance Appraisal Rating Form #119 will be used to document the performance of all non-commissioned correctional officers the rank of sergeant and below. The form is completed by the employee's supervisor to document quarterly evaluations, annual evaluations, and progress reports.

At a minimum, the employee will be rated on the first fourteen (14) categories which are reflective of the job functions of all correctional officers. Corporals will be rated on the first seventeen (17) categories. Supervisors will also be rated on two additional categories which evaluate their management and supervision skills.

Each rating category will be developed by the Deputy Director, Human Resources in conjunction with the Director, CCDC and the Assistant Sheriff of Administration.

#### Quarterly Evaluation

All entry-level probationary correctional officers will be rated quarterly during their probationary period. This will be accomplished through the use of the Correctional Officer Performance Evaluation Rating Form #119. Quarterly evaluations will also be completed, utilizing Form #119, during any approved extensions to an employee's probationary period.

#### Annual Evaluation

Once a correctional officer has gained permanent status, the supervisor will evaluate the officer's performance annually, coinciding with the anniversary of their employment with the Agency. The Rater will prepare the Performance Evaluation by utilizing the Correctional Officer Performance Evaluation Rating Form #119.

#### Progress Report

A Progress Report is an informal tool which may be used at any time during the course of the rating period by a supervisor to address specific areas of an employee's performance that have been identified as Needs Improvement. Progress Reports are instruments of early intervention. They can be used in conjunction with the Remedial Training Worksheet as a means of monitoring, to increase documentation for Entry Level Probationary employees, or to address behavior or performance prior to the need for a Special Evaluation. The progress report will be for a 30-day period. A supervisor and employee conference will be held at the end of the 30-day period. This will be accomplished through the use of the Correctional Officer Performance Evaluation Rating Form.

#### Action Plan



Administrative and Operational Manual

September 12, 2022

An action plan is a proposed program agreed upon by the supervisor and employee to improve performance to an Acceptable performance level or above. Action Plans will be documented to address all areas rated below Acceptable. Action Plans will be documented on the Correctional Officer Performance Evaluation Rating Form.

Action Plans will include:

- Goal setting: what will be accomplished
- Specific tasks: what will be done and by whom
- Time horizon: when will it be done
- Resource allocation: what specific means are available for specific activities

**Rating Categories and Factors**

1. ACCEPTS RESPONSIBILITY, SUPERVISION & CRITICISM - Evaluates the way the employee holds oneself accountable for one's work or actions and strives for continuous improvement of the division's overall effectiveness. Evaluates the way the employee accepts criticism and/or suggestions for improvement as well as how the employee uses that feedback to further the learning process and improve performance.
2. ATTENDANCE (REGULAR & PROMPT) - Evaluates the employee's regular and prompt attendance in relation to Agency policies and procedures and impact on others.
3. DEMEANOR & FLEXIBILITY - Evaluates how the employee views their career in terms of personal motivation, goals and responsibilities of the job. The manner in which one outwardly displays feelings and thoughts concerning themselves, the division, and superiors, etc. Evaluates the ability and willingness to adapt to and work effectively in light of new information, changing situations and/or different environments. The ability to orient oneself to changing conditions.
4. COMMUNICATION SKILLS (ORAL) - Evaluates the ability to gain and maintain control of situations through verbal command and instruction. Communicates openly and effectively with co-workers, supervisors, inmates and the public. Uses effective (clear and concise) spoken communication skills. Satisfactorily adheres to policies concerning phone calls and voicemails.
5. COMMUNICATION SKILLS (WRITTEN) - Evaluates the ability to prepare written documents, without assistance, that accurately reflect the situation in a detailed, organized manner. Evaluates the employee's ability to use proper English and grammar, follow the rules for spelling, and to write neatly when necessary. Evaluates the ability to properly utilize departmental forms.
6. COMPLETION OF WORK ON SCHEDULE / TIME MANAGEMENT - Evaluates efficiency relative to the amount of time taken to complete a task. Efficiently organizes, coordinates and uses available time and resources to achieve division goals. Organizes, schedules and completes work by objectives and guidelines. Completes work in an organized and efficient manner.
7. DECISION MAKING / PROBLEM SOLVING / JUDGEMENT - Evaluates performance in terms of ability to perceive, form valid conclusions, arrive at sound judgements, and make proper decisions. The ability to think clearly and arrive at logical conclusions without supervision.
8. EQUIPMENT MAINTENANCE / PERSONAL APPEARANCE – Evaluates the degree of care and concern demonstrated toward Agency property and issued equipment (vehicles, weapons, uniforms, office equipment, etc.). Reports equipment malfunctions and discrepancies to the proper authority.
9. INITIATIVE / MOTIVATION / TRAINING - Evaluates interest and ability to initiate corrections-related activity. To notice and act on even low-priority situations. Evaluates the amount of acceptable work performed (includes all functions and activities within the employee's daily performance as described in the job description). Does not require daily supervision. Evaluates existing systems and techniques in an effort to be more efficient and





Administrative and Operational Manual

September 12, 2022

effective. Has suggested new procedures, systems and/or devices that save time and/or Agency funds.

10. **JOB KNOWLEDGE** - Evaluates knowledge of departmental procedures and ability to apply this knowledge under field conditions. Fulfills expectations of job classification. Knows and reliably follows department's Standard Operating Procedures. Evaluates how employee understands and applies knowledge of their particular assigned position. Includes how that knowledge is used to achieve personal, unit and division goals. Evaluates the ability to perform routine, non-stress activities. Evaluates ability to perform tasks without injuring self or others or exposing self or others to unnecessary danger/risk.

11. **PERFORMANCE (STRESSFUL CIRCUMSTANCES)** - Evaluates the ability to perform in moderate and high stress situations in relation to the employee's job duties. For example, a use of force situation, skill in vehicle operation under emergency situations and preparing and presenting a significant presentation at meetings or in the media.

12. **QUALITY OF WORK** - Evaluates the degree of excellence of work performed. Includes all functions and activities within the employee's daily performance as described in the job description. Produces high quality of work with few errors and minimal supervision and direction. Does not require continuous oversight by supervisor.

13. **TEAM WORK / WORKING RELATIONSHIPS** - Evaluates the ability to effectively interact with citizens, members of diverse race, ethnicity, and gender groups, and other staff members of various ranks in an appropriate manner.

14. **COMMUNITY / INMATE RELATIONS**- Evaluates the ability to conduct job duties while maintaining effective customer service, using tact, patience and courtesy. Delivers quality customer service.

15. **SUPERVISION AND LEADERSHIP** - Evaluates how well the supervisor provides effective guidance, direction and disciplinary control to staff. This includes the ability to establish clear, measurable goals for staff, and to effectively evaluate and monitor performance through verbal and written feedback. Demonstrates the ability to remain free from bias or favoritism. Completed evaluations are a sufficient depiction of staff's performance.

16. **DELEGATING** - Evaluates the ability to entrust employees with responsibilities and authority, and creates accountability for results. Evaluates the ability to provide clear and motivating direction for work assignments.

17. **PLANNING AND ORGANIZATION** - Evaluates the ability to multi-task and follow through on assignments despite setbacks. Evaluates the ability to plan and schedule work for self and others to meet objectives and goals.

18. **RATING** -This category is part of the evaluation only for supervisors who rate or evaluate other employees. Here they are evaluated on how much effort, how much documentation and how they communicate the evaluation to the employee.

19. **DEVELOPMENT OF EMPLOYEES** - Evaluates the ability to set performance goals and apply them in a timely, accurate, fair and consistent manner. Evaluates the ability to effectively coach, mentor and plan for development.

**Rating Scale Definitions**

- **UNACCEPTABLE** – Performance fails to meet Agency standards and expectations. (Attached documentation required)
- **NEEDS IMPROVEMENT** – Performance is inadequate, often requiring close supervision.
- **ACCEPTABLE** – Performance fully meets standards and expectations.
- **PROFICIENT** – Performance shows an advanced degree of competency.
- **OUTSTANDING** – Performance significantly exceeds standards and expectations, generally recognized by



Administrative and Operational Manual

September 12, 2022

peers, supervisors and commanders for their performance. (Attached documentation required)

Documentation for Unacceptable or Outstanding performance may include, but is not limited to, the following: awards; citations; conference forms; supervisor notes; work samples; official documents; third party letters, emails, and notes; magazine and newspaper publications.

### 3-650.5 SWORN POLICE OFFICER PERFORMANCE EVALUATION SYSTEM

Sworn police officers shall fall into one of three categories for purposes of evaluating their performance.

- **Probationary Status, Non-Solo Officer:** Entry-level officers who are on probation and have not yet completed the required formal entry-level training to be considered solo officers.
- **Probationary Status, Solo Officer:** Officers who have completed their entry-level training and are working as solo officers, however, are still in a probationary status.
- **Permanent Status:** Officers who are performing as solo officers and have reached permanent employment status.

Probationary, non-solo officers will be rated on basic overall performance. Probationary solo officers and permanent status officers will be rated in four basic categories which are reflective of the job functions of all baseline police officers. Supervisors will also be rated on their management and supervision skills. Officers assigned to specialized functions of the Agency will also be evaluated on functions specific to those assignments.

#### 3-650.5.1 PROBATIONARY SWORN POLICE OFFICER EVALUATION (PROBATIONARY STATUS, NON-SOLO OFFICER)

Prior to completing all required formal entry-level training, probationary, non-solo officers shall receive quarterly evaluations by utilizing Form #64A. Officers will continue to receive these quarterly evaluations until such time as they have completed their formal entry-level training and are considered solo officers. Quarterly evaluations will also be completed, utilizing Form #64A, during any approved extensions to an employee's probationary period.

#### 3-650.5.2 SWORN POLICE OFFICER EVALUATION (PROBATIONARY STATUS, SOLO-OFFICER)

Once an officer has completed all required formal entry-level training and is considered a solo police officer, he shall receive the same evaluation as a permanent status officer. Since the officer will still be in a probationary status, they shall be rated every quarter until reaching permanent status. Form #64 shall be utilized for this purpose.

#### 3-650.5.3 NON-COMMISSIONED SWORN POLICE OFFICER EVALUATION (PERMANENT STATUS)

The evaluation system described in this section shall be used for permanent status, solo police officers of the Charles County Sheriff's Office the rank of POI through Sergeant. The evaluation shall be completed twice yearly for each officer and submitted, via the chain of command, to Human Resources within thirty (30) days of the close of the evaluation cycle. Form #64 shall be utilized for this purpose.

#### Evaluation Cycles

- Evaluation Cycle 1: January 1 through June 30
- Evaluation Cycle 2: July 1 through December 31



## Administrative and Operational Manual

September 12, 2022

When completing the performance evaluation form, the Rater will circle the appropriate cycle (1 or 2).

**Rating Categories**

When rating the employee, the Rater may select one of three options to describe the employee's performance:

- Acceptable (A),
- Needs Improvement (NI), or
- Outstanding (O).

If the employee does not routinely perform the task as part of their assigned job function, the Rater should select the block labeled Not Applicable (N/A).

The Performance Evaluation form is comprised of four standard categories, one management category, and four special assignment categories. Listed under each category are tasks or job requirements related to the category. Each category will be developed by the Deputy Director, Human Resources Section in conjunction with the Assistant Sheriffs of Administration and Operations.

Generally, all employees should be evaluated by the four standard categories:

- **Fundamentals,**
- **Officer Initiated Field Contacts/Traffic,**
- **Report Writing and**
- **Time Management and Job Knowledge.**

If the employee is the rank of Corporal or Sergeant, the Rater shall also complete the evaluation section titled **Management and Supervision**.

If the employee is assigned to one of the four specialized assignments, the Rater will complete the appropriate categories under the **Specialized Agency Assignments** section.

**Rating Criteria**

When considering the appropriate rating for a given task or job function, the Rater should consider the quality, frequency and/or proficiency of the standard being evaluated as demonstrated by the employee.

- **Acceptable (A)** The employee performs the task satisfactorily most of the time or engages in an activity at an acceptable rate of frequency. If the employee is at a reasonable and acceptable level, the Rater should select the ACCEPTABLE rating.
- **Needs Improvement (NI)** If the employee's proficiency or performance of the standard or task being measured requires improvement or additional training to rise to the level of acceptable, the Rater should select the NEEDS IMPROVEMENT rating.

The Rater must further explain any standard rated as NEEDS IMPROVEMENT in the section of the evaluation titled **Discuss Performance Weaknesses and Improvement Plan**. The explanation should be brief and include a plan to help the employee meet the standard during the next evaluation cycle.

- **Outstanding (O)** The employee shows a strong understanding of a standard, performs a task with high frequency and at a more than above average level, or is highly skilled at a task beyond that of an average officer with similar years of service and rank.



## Administrative and Operational Manual

September 12, 2022

The Rater must describe any standard rated as OUTSTANDING in the section of the evaluation titled **Discuss Performance Strengths**. The explanation should be brief but contain justification for the rating of OUTSTANDING.

- **Not Applicable (N/A)** The employee does not perform the listed job function or is not required to meet the listed standard due to a specialized assignment. This rating should not be used if the employee is expected, based on section or division assignment, to complete the task but fails to do so.

### 3-650.6 CIVILIAN PERFORMANCE EVALUATION SYSTEM

Civilian quarterly probationary evaluations, annual performance evaluations and special evaluations will be documented using the Civilian Evaluation Form #64C.

Supervisors will evaluate civilians each quarter during the probationary period they serve after beginning employment or transferring to a new position within the Agency. Quarterly evaluations will also be completed during any approved extensions to an employee's probationary period.

Once the civilian employee has gained permanent status, the supervisor will evaluate the civilian's performance annually, coinciding with the anniversary of their employment with the Agency.

#### Rating Categories

Civilians will be evaluated on six basic categories, each of which provides both basic and specific feedback to the wide range of job tasks performed by the Agency's civilian staff. Each category will be developed by the Deputy Director, Human Resources in conjunction with the Assistant Sheriffs of Administration and Operations.

These categories are:

- Professional Demeanor,
- Attitude,
- Job Knowledge,
- Quality of Work,
- Dependability and Attendance, and
- Communications Skills.

In addition, civilian supervisors will be rated on their management and supervisory skills.

#### Rating Criteria

When considering the appropriate rating for a given task or job function, the Rater should consider the quality, frequency and/or proficiency of the standard being evaluated as demonstrated by the employee.

- **Acceptable (A)** The employee performs the task satisfactorily most of the time or engages in an activity at an acceptable rate of frequency. If the employee is at a reasonable and acceptable level, the Rater should select the ACCEPTABLE rating.
- **Needs Improvement (NI)** The employee's proficiency or performance of the standard or task being measured requires improvement or additional training to rise to the level of acceptable, the Rater should select the NEEDS IMPROVEMENT rating.  
The Rater must further explain any standard rated as NEEDS IMPROVEMENT in the section of the evaluation titled **Level of performance expected, improvement plan (if applicable) and goals for upcoming rating period**. The explanation should be brief and include a plan to help the employee meet the standard during the next evaluation cycle.



## Administrative and Operational Manual

September 12, 2022

- **Outstanding (O)** The employee shows a strong understanding of a standard, performs a task with high frequency and at a more than above average level, or is highly skilled at a task beyond that of an average employee with similar years of service and grade.

The Rater must describe any standard rated as OUTSTANDING in the section of the evaluation titled ***Level of performance expected, improvement plan (if applicable) and goals for upcoming rating period.*** The explanation should be brief but contain justification for the rating of OUTSTANDING.

- **Not Observed (N/O)** The employee does not perform the listed job function or is not required to meet the listed standard due to a specialized assignment. This rating should not be used if the employee is expected, based on section or division assignment, to complete the task but fails to do so.

### 3-650.7 ANNUAL PERFORMANCE EVALUATIONS FOR MANAGEMENT AND COMMANDERS

All commissioned officers the rank of lieutenant and above, the General Counsel and civilian directors and deputy directors who have attained permanent status will receive an annual evaluation of their performance. This evaluation will be to determine if the employee's overall performance is at a level that is satisfactory to their supervisor. This evaluation will be documented on Form #64B. These evaluations are exempt from the supervisor review process.

### 3-650.8 PERFORMANCE EVALUATION SUPERVISORY REVIEW

Upon completion of the performance evaluation form, the Rater shall meet with their supervisor (the Reviewer) to discuss each performance category as well as the employee's strengths, weaknesses and expectations. The Reviewer and the Rater will acknowledge the review process was completed by signing and dating the evaluation.

In cases of disagreement between the Rater and the Reviewer, they will discuss the discrepancy and reach an agreement on the performance evaluation prior to the presentation to the employee. If an agreement cannot be reached, the Reviewer has the authority to change ratings or make comments on the evaluation form and reflect a new overall rating. This new rating will be the official rating. However, before the Reviewer makes any rating changes, he will consult with the employee's division commander.

### 3-650.9 PERFORMANCE EVALUATION CONFERENCE

Each supervisor rating an employee shall meet with that employee to provide them a copy of the evaluation as well as discuss the employee's performance during that rating period.

During this conference, the supervisor (Rater) and the employee shall accomplish the following:

- Review the position description;
- Discuss results of performance evaluation;
- Discuss level of performance expected and goals;
- Review the employee's accomplishments during the covered evaluation period;
- Clearly define any deficiencies in the employee's performance and what is expected to be accomplished in order to bring performance to the expected level; and
- Discuss career paths and opportunities for the employee on advancement, possible special assignments, and/or training opportunities.

The Rater will ensure the employee's job description and the Harassment and Beneficiary Annual Review Form #65 are presented, completed, signed and attached to the performance evaluation. For sworn police officers, this will be accomplished during the Evaluation Cycle 2.

**Administrative and Operational Manual****September 12, 2022**

At the conclusion of the conference, the employee may make written comments on the performance evaluation. The employee may take up to 48 hours to prepare and attach their comments or present additional documentation they deem appropriate.

The employee will sign the evaluation form acknowledging they have received the evaluation. The employee's signature will not indicate agreement or disagreement with the evaluation. The evaluation form will then be forwarded to the employee's Division Commander and then the Human Resources Section to be placed in the employee's personnel file.

Once all parties have signed the evaluation form and all appeals, if applicable, have been satisfied, the Human Resources Section will provide an electronic copy of the completed and signed evaluation form to the affected employee.

**3-650.10 TRANSFERS AND REASSIGNMENTS DURING RATING PERIODS**

Supervisors are responsible for ensuring interim evaluations are completed anytime the supervisor or a subordinate employee is transferred, reassigned or promoted during a rating cycle. This will be accomplished through the use of the appropriate rating form for that Agency segment and by indicating it is an interim evaluation at the top of the respective form.

Upon notice of the transfer or reassignment of an employee, the current supervisor will complete an interim evaluation covering the time elapsed in the employee's current evaluation cycle. The interim evaluation will be completed prior to the employee's transfer or reassignment. The current supervisor will communicate the results of the interim evaluation to the employee and the employee will sign the interim evaluation form to acknowledge he has received the evaluation. The current supervisor will provide the original, signed interim evaluation form to the employee's new supervisor to be used in completing the subordinate employee's next regularly scheduled performance evaluation. The interim evaluation form will be attached to the affected employee's next regular evaluation.

Should a supervisor responsible for evaluating subordinate employees be promoted or transferred to a new squad/unit, the outgoing supervisor will complete an interim performance evaluation for each employee they supervise. The interim evaluations will be completed prior to the supervisor's transfer or reassignment. The outgoing supervisor will communicate the results of the interim evaluation to each employee and each employee will sign their interim evaluation form to acknowledge they have received the evaluation. The outgoing supervisor will then provide the original, signed evaluation forms to the incoming supervisor to be used in completing the subordinate employees' next regularly scheduled performance evaluations. The interim evaluations will be attached to the affected employees' next regular evaluation.

**3-650.11 USE OF PERFORMANCE EVALUATION RESULTS**

Performance evaluation rating results may be used in the following instances:

- Gaining permanent status for employees in a probationary status;
- Granting or denying salary step/merit increases for those employees whose salary increases are dependent on the performance evaluation;
- Consideration for transfer to or from a particular division, section, or unit, or special assignment;
- Consideration for promotion; and/or
- Retention or termination.

An employee will be denied a salary step/merit increase if the employee has received two or more rating factors which have been deemed below acceptable standards on the employee's most recent performance evaluation or special evaluation.



**Administrative and Operational Manual**

**September 12, 2022**

The employee will be eligible for the salary step/merit increase at the beginning of the next pay period following the successful achievement of Acceptable ratings in the deficient categories. Salary increases will not be retroactive.

An employee may be denied transfer or assignment to a specialized unit if they do not receive an Acceptable rating or better in all factors as documented in the employee's most recent performance evaluation. Once an employee is qualified for the promotional process, they must maintain an Acceptable rating or above in all factors to remain eligible for promotion.

**3-651 RATING APPEAL PROCESS**

Employees receiving a performance evaluation are eligible to appeal their rating if there is a disagreement between the employee and the Rater and a consensus could not be reached. Probationary quarterly evaluations are not subject to appeal.

If an employee has elected to appeal their evaluation, the first step is to meet with the Reviewer listed on the evaluation form. The Reviewer will discuss the evaluation with the employee. If the employee still wishes to appeal their evaluation, the employee must file their appeal with the Human Resources Section within seven (7) days of the meeting with the reviewer.

The appeal will be in form of a memorandum addressed to Deputy Director, Human Resources Section. The memorandum will specifically list the portions of the evaluation which are being appealed. The specific reasons the employee believes the rating is in error shall be stated. The specific relief sought (i.e., "the rating on a particular factor should be changed to...") shall be stated. A summary of any evidence to be presented shall be given and a copy of any supporting documents shall be attached to the appeal memorandum. The appeal hearing shall be narrowly and specifically limited to the matters and points raised in the appeal memorandum. No general "I think I deserve a higher evaluation" type of appeals will be entertained.

The Assistant Sheriff of Administration will appoint a Rating Appeal Board, consisting of three employees, at least one of whom will be from the same segment of the Agency as the appealing employee. The board will be formed and hold the rating appeal hearing in accordance with the policy outlined in the Administrative Services SOP.

At the conclusion of the hearing, the board shall make a determination as to the validity of the appeal. The determination of the Board will be by majority vote (two or more members). In cases when the decision of the Board is to amend a performance evaluation, the Chairman shall make the appropriate entry on the performance evaluation. In all cases, a memorandum to the employee's personnel file, explaining the Board's actions, will be generated by the Chairman and forwarded with the performance evaluation to the Commander / Director, Administrative Services Division.

The Commander / Director, Administrative Services will advise the appealing employee, rater, reviewer, division commander and the Assistant Sheriff, by memorandum, as to the Board's action. The decision of the Appeal Board shall be final.

**3-652 SPECIAL EVALUATION FOR UNACCEPTABLE PERFORMANCE**

A Special Evaluation is a formal tool to be used to document employee performance which is unacceptable or needs improvement. Special Evaluations are not to be used for entrance level probationary employees. The Special Evaluation may be used during probationary periods after receiving a promotion. The receipt of a Special Evaluation is not grounds for filing a grievance.

Generally, a Special Evaluation is used when a supervisor identifies a subordinate with an ongoing performance problem. At any point during the rating period when an employee's performance diminishes to Unacceptable or Needs Improvement, the supervisor must take corrective action.



## Administrative and Operational Manual

September 12, 2022

The following guidelines shall be followed:

- When an employee is deemed Unacceptable or Needs Improvement in one rating category, then it is at the supervisor's discretion as to whether or not a Special Evaluation is initiated.
- When an employee's performance is deemed Unacceptable or Needs Improvement in two or more rating factors, a formal process becomes necessary, and the supervisor shall initiate a Special Evaluation.
- Additionally, if a **sworn police officer** is rated Needs Improvement in the same rating category on two consecutive performance evaluations, a formal process becomes necessary and the supervisor shall initiate a Special Evaluation.

This policy does not prevent a Rater, with proper documentation of an employee's poor performance, from giving a "Needs Improvement" or "Unacceptable" rating on an evaluation. It does also not prevent a supervisor from initiating a Special Evaluation if the employee is performing below acceptable standards in one rating factor.

The Special Evaluation is accomplished by using the performance evaluation form that corresponds with the employee's classification segment (Form #64 for sworn police officers, Form #64C for civilians and Form #119 for Corrections) and by indicating that it is a Special Evaluation on the form. The completion of the form notifies the subordinate of the specific below standard performance and directs them to improve their performance in these areas during the special evaluation period. To initiate the Special Evaluation, the supervisor shall:

- Prepare a full evaluation for the employee;
- Indicate the evaluation will be used as a Special Evaluation;
- Explain in detail the performance which is not acceptable;
- Explain the expected level of performance and offer guidance on how to achieve it;
- Outline any prior corrective actions taken; and
- Forward the form through the chain of command to the division commander / director for review and recommendation.

If the Special Evaluation is authorized, it will be returned to the Rater, who will coordinate with Human Resources to properly implement the Special Evaluation process.

During the special evaluation cycle, the supervisor must ensure they are providing the proper direction to the employee to ensure they are clear on the supervisor's expectations. The supervisor shall then meet with the employee every thirty (30) days to review and document the employee's progress. These meetings may occur up to ninety (90) days or until the employee's performance improves to an acceptable level. These conferences are to be recorded on the corresponding evaluation form.

The Rater will indicate the start date and end date of the Special Evaluation Cycle in on the evaluation form. If the Special Evaluation is the first of the Special Evaluation series, the Rater will select **Initial** for the Special Evaluation period. If the form is being used to document employee progress during the Special Evaluation process, the Rater will select the appropriate progress interval (30/60/90 days).

Each form is then forwarded through the chain of command to the division commander / director for review. The commander / director will forward the evaluation to Human Resources. Human Resources shall place the Special Evaluation in the employee's personnel file. Once the employee's performance has improved to at least an Acceptable level, the supervisor shall forward a memorandum and a memorandum cover sheet (Inter-Office Memorandum, Form #144) through the chain of command recommending the employee be removed from the Special Evaluation process.

If the 90-day special evaluation period coincides with the date for a regular performance evaluation, there will be no need for the regular evaluation. The special evaluation will serve as the evaluation for that cycle.





Administrative and Operational Manual

September 12, 2022

During the time an employee is in a Special Evaluation status, they will not be eligible for advancement by promotion, a requested transfer, or for reassignment.

During the time a supervisor or above is placed in a Special Evaluation status all rating responsibilities will be suspended. During this period, the division commander / director will designate an alternate Rater.

Upon the successful conclusion of the Special Evaluation, the employee will obtain the eligibility status held prior to the Special Evaluation.

Eligibility for step increases originally scheduled during the time of the Special Evaluation will start with the pay period following the successful conclusion of the Special Evaluation period. Salary increases will not be retroactive.

If at the conclusion of the 90-day Special Evaluation period the employee's performance has not improved to a rating of Acceptable in all factors, the employee's division commander / director shall meet with Human Resources and, based on the immediate circumstances, make a joint recommendation to the appropriate Assistant Sheriff. A recommendation may include, but not be limited to, the following courses of action:

- Extension of the Special Evaluation period;
- Formal remedial training;
- Transfer / reassignment;
- Demotion; and/or
- Termination.

### 3-653 ANNUAL HARASSMENT AND BENEFICIARY REVIEW

Supervisors will provide each employee with an electronic copy of the Agency's harassment policy as well as ensure the employee knows and understands the process for reporting any instances of harassment within the workplace. In addition to the harassment policy, supervisors shall also ensure the employee understands the importance of updating their beneficiary information as well as their personal contact information within Human Resources.

The supervisor should conduct this review annually while meeting with the employee at the conclusion of the evaluation conference and document this review on CCSO Form #65.

- For **probationary sworn police officers, correctional officers and civilian employees**, this process will be conducted during the employee conference following the fourth quarter performance evaluation.
- For **non-probationary sworn police officers**, this process will be conducted during the Cycle 2 performance evaluation employee conference.
- For **non-probationary civilians and correctional officers**, this process will be conducted during the annual performance evaluation employee conference.

If an employee indicates they are unsure of any of the processes referenced, the supervisor will provide the employee with directions or resources to assist them. The resources/guidance provided will be documented in the comments section of the form.

### 3-654 PROMOTIONS - SWORN LAW ENFORCEMENT AND CORRECTIONAL OFFICERS

This system of advancement for police and correctional officers is created at the direction of the Sheriff by the

**Administrative and Operational Manual****September 12, 2022**

Agency Promotional Process Development Committee and in collaboration with the International Association of Chiefs of Police (IACP), and with input from officers within the system. The system is established as the formal framework for the selection and promotion of employees within the ranks of Corporal, Sergeant, and Lieutenant. The goal is to manage, with the partnership of the IACP, a promotional process using proven methods that guarantee fairness, integrity, and successful outcomes for personnel and the Agency as a whole. As appointing authority of the merit system, the Sheriff will authorize all promotions and permanent status.

**3-654.1 SECURITY AND CONFIDENTIALITY**

The Sheriff will appoint an Agency employee as Chairman of the Agency Promotional Process Development Committee. The Chairman shall be responsible for the administration of the promotional process. This will be accomplished with the assistance of the Human Resources Section, along with input and direction which will be provided by the Agency Promotional Process Development Committee members and the International Association of Chiefs of Police.

It is essential that all portions of the promotional process remain fair and equitable for all participants. To ensure this, employees shall not disclose information pertaining to any portion of the promotional process to any participants if doing so would provide an unfair advantage over other participants. Anyone providing or receiving such information will be subject to disciplinary action.

The Agency strives to provide for an open and honest system and to ensure the integrity of the entire process. All elements of the promotional process are promulgated, scored, and the results recorded by the IACP. The results are then provided to the Agency and all tests, resume results, in-basket results, answer keys, and numerical ranking of candidates will be secured in the offices of the Human Resources Section. Access to these files shall be controlled and recorded and is limited to the Sheriff, the Assistant Sheriff of Administration, the Commander/ Director of Administrative Services, and specifically designated Human Resources personnel. Access to secured files by anyone other than the employees listed above will be granted only upon written approval of the Sheriff.

**3-654.2 APPLICATION FOR PROMOTION**

For promotion to the ranks of Corporal, Sergeant, and Lieutenant, the candidate must submit an Agency Application for Promotion Form #645. The application must be received by Human Resources no later than 1600 hours on the first Friday of October preceding the start of the promotional cycle.

**3-654.3 REQUIRED ELEMENTS**

For all ranks (sworn/ corrections) within the promotional process there are several required elements. Each element must be satisfied in order for the officer to meet eligibility requirements and be placed on the promotional eligibility list.

Most elements consist of a single compliance date, and the officer must meet the requirements on or before the specific due date of that element. Elements include:

- Application for Promotion - First Friday in October by 1600 hours, odd numbered year;
- Submission of Resume - Close of business the second Friday following the written examination date;
- Written Examination and In-Basket Exercise - First Sunday in April, even-numbered year, unless the first Sunday is a holiday, in which case it will be moved to the second Sunday in April;
- Oral Board - completed as soon as practical after the written examination date.

For each rank (sworn/ corrections) a maximum of 140 points may be accumulated in the following categories:



Administrative and Operational Manual

September 12, 2022

- Resume review 30 points
- Written examination 50 points
- In-Basket exercise 30 points
- Oral Board 30 points

In the event of unforeseen weather-related or other emergencies, the process may be delayed for up to two weeks. A predetermined “rain/ snow” date will be established. Candidates will be responsible for being available for those dates.

### 3-654.4 COMPETITIVE PROCESS

Candidates for all ranks, both sworn and corrections, must complete each of the four competitive requirements: Resume, Written Examination, In-Basket, and Oral Board in order to be placed on the promotional eligibility list.

Candidates for all ranks scoring within the top 50% on the written examination will have their overall combined scores from each of the four promotional segments totaled and ranked on the eligibility list. This 50% requirement may be adjusted by the promotional committee, if necessary, depending on the number of applicants competing for the specific ranks, to ensure there will be a sufficient number of candidates to fill the projected vacancies within the individual ranks.

#### 3-654.4.1 RESUME COMPONENT

For promotion to the ranks of Corporal, Sergeant, and Lieutenant, a resume must be provided to Human Resources.

In lieu of having a performance evaluation score used in the promotional process, the candidates will use the resume component as a method of performing a self-evaluation as an overview of their qualifications and performance. The candidates should include as much information in the resume about their past performance as they feel should be known by the review panel.

This component is designed to measure the candidate’s performance, experience, training, and contributions to the Agency. The resumes will be evaluated by an outside entity contracted by the Promotional Committee, such as the IACP.

Human Resources will date and time stamp the resume front page upon receipt. The candidate may earn one (1) point for resume submission and development. Measurement criteria will include: timely submission, proper format, accuracy, grammar, and spelling. Twenty-nine (29) additional points may be earned from the resume review.

Candidates are responsible for the accuracy of the information contained in their resumes. In order to ensure the integrity of the process for everyone, the candidates will provide the completed resume to their immediate supervisor for review. The resume shall be reviewed by a supervisor and/or other appropriate personnel to ensure the accuracy of its content. The applicants may submit the completed original resume to Human Resources any time prior to the deadline; however, the supervisory review must be accomplished prior to the resume being forwarded for scoring. The reviewing supervisor shall complete the Supervisory Review of Resume Form #306 and forward to HR.

The supervisor’s responsibility will be to assess the resume for any obvious inaccuracies, note the inaccuracies, and return to the candidate. The supervisor may consult with prior supervisors or review the candidate’s personnel file to verify information he may not be familiar with. Any blatantly dishonest information found during the review raises an integrity issue and shall be reported up the chain of command to the Assistant Sheriff of Administration. Such an issue may lead to the candidate’s disqualification from the promotional process and further disciplinary action.

The resume must be submitted no later than 1600 hours on the second Friday following the written examination date. It is the candidate’s responsibility to ensure delivery to Human Resources by the due date. Therefore, hand



**Administrative and Operational Manual**

**September 12, 2022**

delivery is recommended. Applicants are responsible to take into account weather-related closures, which will not be considered as an excuse for late submission.

**3-654.4.2 WRITTEN EXAMINATION**

The written examination is prepared by the IACP, based on information and study materials submitted by the Promotional Process Committee.

**3-654.4.3 IN-BASKET EXERCISE**

This component consists of an in-basket exercise that is designed to measure the candidate's ability to resolve issues and prioritize responsibilities in the most effective manner available.

Candidates will participate in an in-basket exercise where the types of situations a successful candidate might encounter on a daily basis are handled. Various types of correspondence are given to the candidate, who is then required to sift through the information and decide what to do with each item.

**3-654.4.4 ORAL BOARD**

The oral board will evaluate the candidate's ability to convey his thoughts associated with past experience, skills, and problem solving techniques.

Oral boards will be scheduled as soon as practical following the written examination date.

**3-654.5 APPEAL PROCESS**

The written examination portion of the promotional procedures does have an appeal process; however, the final scores for the in-basket, resume, and oral board do not have an appeal process.

**3-654.6 PROMOTIONAL PROCEDURES**

Nothing in this promotional policy shall be construed to require the promotion of any officer because eligibility requirements are met. Many factors including, but not limited to, budget and Agency administrative considerations, impact the decision of the Sheriff to authorize promotions.

In-grade service must be within the Agency segment, position, rank, or grade specified. For example, service in the rank of Corporal within Corrections would not qualify for promotion to the rank of Sergeant within the Sheriff's police officer ranks.

Sworn court security officers have no avenues of advancement through the sworn or correctional ranks. However, they may apply for a position as an entry level police or correctional officer if they meet the established qualifications. In cases where the officer is the subject of an Agency internal investigation, or any criminal investigation, the Sheriff, with input from the officer's division commander and the Commander, Office of Professional Responsibility, will determine, based on the nature of the allegations and available information, the officer's eligibility.

Human Resources is responsible for providing candidates with information pertaining to the promotional process. This information, provided by the IACP, includes, but is not limited to: a study materials list, resume guidelines/training, and in-box guidelines/ training.

**3-654.7 PROBATIONARY POLICE OFFICER TO POLICE OFFICER II**

To be eligible for promotion to PO II, the officer must achieve permanent status. The employee's release from entry level probation and promotion to PO II will take place only after authorization of the Sheriff.



Administrative and Operational Manual

September 12, 2022

- There is no probationary period for the rank of PO II and therefore permanent status is automatic upon promotion.

In the event a probationary officer has not achieved sufficient proficiency to justify permanent status and promotion to Police Officer II at the end of the probationary period, the Sheriff may:

- terminate the officer's employment; or
- extend the officer's probation to allow for an interim rating process to gauge whether or not sufficient progress has been made to warrant permanent status.

### 3-654.7.1 PROBATIONARY CORRECTIONAL OFFICER I TO PROBATIONARY CORRECTIONAL OFFICER II

To be eligible for promotion to CO II, the officer must successfully complete formal entry level training as outlined under AOM 3-602.6 Probationary Periods, be recommended for promotion and approved for promotion by the Sheriff. The CO I promoted to CO II will continue probation for one year following the completion of formal entry level training. Once the probationary period has been successfully completed the CO II will be eligible for permanent status. Permanent status will take place only after authorization of the Sheriff.

In the event a probationary officer has not achieved sufficient proficiency to justify permanent status at the end of the probationary period, the Sheriff may:

- terminate the officer's employment; or
- extend the officer's probation to allow for an interim rating process to gauge whether or not sufficient progress has been made to warrant permanent status.

### 3-654.7.2 PROMOTION TO PFC/ CFC

In order to be eligible for promotion to PFC, a PO II must have served three (3) years as a police officer with the Charles County Sheriff's Office within their current segment and scored a minimum of 70% on a written exam.

In order to be eligible for promotion to CFC, a CO II must have served two (2) yeas as a correctional officer with the Charles County Sheriff's Office within their current segment and scored a minimum of 70% on a written exam.

If the minimum score of 70% is not achieved, the officer may request a make-up exam through Human Resources. The make-up exam must be taken within thirty (30) days of the first exam and will be scheduled by Human Resources. The minimum passing score for the make-up exam is 70%. If a score of 70% is not obtained on the make-up exam, the officer must wait until the next regularly scheduled exam to re-test.

The PFC examination will be administered by Human Resources on a bi-annual basis. The tests will occur on the first Tuesday of each June and December. Eligible officers will be scheduled to take the test on the date that falls immediately prior to the first date they are eligible for promotion. Once an officer is eligible for promotion to the rank of PFC, the officer will be placed on an eligibility list in the order of their eligibility date. Promotions will be made from this list in the order of eligibility, and once officers are placed on this list they remain until promoted.

CFC testing will take place approximately one month before their eligibility for promotion to CFC. If the minimum score of 70% is not achieved, the correctional officer may request a make-up exam through Human Resources. The make-up exam must be taken within thirty (30) days of the first exam and will be scheduled by Human Resources. The minimum passing score for the make-up exam is 70%. If a score of 70% is not obtained on the make-up exam, the officer must wait six (6) months before being eligible to test once again.

### 3-654.7.3 PROMOTION TO CORPORAL



**Administrative and Operational Manual**

**September 12, 2022**

In order to be eligible to compete for promotion to the rank of Corporal, the PFC/ CFC must be eligible for permanent status and have or will have served five (5) years with the Agency within his current segment by July 1 of the even numbered year of the promotional cycle; or the PFC/ CFC must be eligible for permanent status and have or will have served five (5) years with the Agency within his current segment by July 1 of the odd numbered year of the promotional cycle. If the officer does not meet either of these requirements, he will not be eligible to participate in the promotional process.

**3-654.7.4 PROMOTION TO SERGEANT**

In order to be eligible to compete for promotion to the rank of Sergeant, the Corporal must be eligible for permanent status by the beginning of the promotional cycle. If the Corporal is not granted permanent status by the beginning of the promotional cycle, he will not be placed on the eligibility list for promotion.

**3-654.7.5 PROMOTION TO LIEUTENANT**

In order to be eligible to compete for promotion to the rank of Lieutenant, the Sergeant must have gained permanent status. The sworn Sergeant must have served a minimum of twelve (12) calendar months as a permanent status Sergeant by the beginning of the promotional cycle (July 1, even-numbered year). Correctional Sergeants are not required to serve a minimum time in permanent status.

**3-654.8 ELIGIBILITY LIST**

For promotion to the ranks of Corporal, Sergeant, and Lieutenant, a two (2) year eligibility list will be maintained. This promotional cycle will be effective from July 1 of an even numbered year, through June 30 of the next even numbered year.

Once established, the total score of those officers on the eligibility list will remain constant and will not change during the life of the promotional cycle.

Officers meeting all eligibility requirements will remain on the respective eligibility list until removed by promotion or as directed by a notice of final disciplinary action.

In the event of a tie, officers will be placed on the eligibility list first by time in grade in current rank. If not resolved at that point, then resolution will be by seniority as a police / correctional officer with the Agency. If the tie is not broken, the Sheriff may, in his sole discretion, rank the tied officer candidates.

Should a sworn officer whose name appears on the respective eligibility list receive disciplinary action for any offense which results in demotion (temporary or permanent) or suspension without pay for any period, the name of that officer will be removed from consideration for promotion during the period of demotion and/or suspension, as specified in the final disciplinary action. Those PFCs/ CFCs who have met all eligibility requirements by July 1 of an even numbered year will be placed on the eligibility list effective July 1 of that even numbered year. Those PFCs/ CFCs who will meet all eligibility requirements by July 1 of the odd numbered year will be permitted to participate in the promotional process, but will not be eligible for placement on the promotional list until July 1 of the odd numbered year. The recalculated eligibility list for promotion will become effective on July 1 of odd numbered years and will consist of all eligible candidates listed in descending order in relation to total points earned.

For promotion to the ranks of Sergeant and Lieutenant, a competing officer must have gained permanent status in his current rank and meet all other eligibility requirements by the beginning of the promotional cycle (July 1 of even numbered year) in order to be eligible to participate in the promotional process.

**3-654.9 SPECIAL ACCOMMODATION**

An officer who fails to comply or who will not be able to comply with the time frame established for a specific element(s) may request a special accommodation. The request must specifically state the reason for non-



**Administrative and Operational Manual**

**September 12, 2022**

compliance and the remedy that is being sought.

The request must be submitted to the Chairman of the Agency Promotional Process Development Committee, who will convene the Promotional Process Development Committee. The Committee will review the request and forward their written recommendation to the Assistant Sheriff of Administration. The Assistant Sheriff's decision will be final. The requesting officer will be notified in writing of the final decision.

In the event an officer has a conflict with the written exam/ review date due to a conflicting Agency assignment, the commander under whose authority the conflict exists will request, in writing, an accommodation. The request will be processed in the same manner as an officer's request; however, once validated that the conflict was Agency specific, the officer will be accommodated. Commanders are cautioned to avoid this type of conflict and only emergency situations should apply.

Those conflicts that are Agency specific or resulting from activation to military service will be reviewed on an individual basis by the Committee, and a recommendation regarding special accommodations will be presented to the Assistant Sheriff of Administration.

**3-654.10 SELECTION PROCESS**

In making promotions from the respective competitive eligibility list, the Sheriff shall select for each position an officer whose score is included in the five highest, exclusive of those officers who decline promotion, request they not be considered, or are removed from the list in accordance with this policy.

**3-654.11 PROMOTION WHILE ON EXTENDED SICK AND SAFE LEAVE, INJURED IN THE LINE OF DUTY LEAVE, NON-OFFICER STATUS, OR MODIFIED DUTY - SWORN AND CORRECTIONAL OFFICERS**

Those officers who become eligible for promotion to PO II / CO II or PFC / CFC will be considered on a case-by-case basis. Consideration will be given to:

- the nature of the officer's temporary disability and prognosis for return to duty;
- whether the officer is going to return to work;
- when the officer is going to return to work; and
- whether the officer meets all eligibility requirements.

Officers certified for promotion by their participation in the competitive process and placement on the respective eligibility list for promotion will be considered for promotion to Corporal, Sergeant, or Lieutenant on a case-by-case basis. Considerations will be given to the nature of the officer's temporary disability and prognosis for return to duty.

**3-655 EMPLOYEE'S PERSONNEL FILE**

No materials shall be placed in the employee's personnel file unless the employee has an opportunity to review, sign, receive a copy of, and comment in writing upon the material, unless the employee waives these rights.

**3-655.1 ADVERSE MATERIAL**

Adverse material (letters of censure, reprimand, etc.) shall be placed in the affected employee's personnel file in accordance with procedures in Section 3-655.

**3-655.2 CONFERENCE FORMS**

Employee Conference Forms #180 are utilized by this Agency to document both positive and unfavorable



## Administrative and Operational Manual

September 12, 2022

performance, actions and deeds of its members. These forms shall be placed in the respective employee's personnel file, after review by the Sheriff, in accordance with procedures in Section 3-655.

- Employee Conference Forms containing adverse material shall be removed from the employee's personnel file one year from the date of its placement. When removed, Conference Forms will be sealed and forwarded to the respective employee.
- Positive Employee Conference Forms shall remain in the employee's personnel file indefinitely.
- Both positive and negative Employee Conference Forms that are attached to another document within the employee's personnel file, such as a performance evaluation, will remain part of that document and will not be subject to removal.

### 3-656 AGENCY AWARDS

Agency awards are a manner in which the Agency recognizes extraordinary efforts of its employees in the performance of their duties. They also provide a means of recognizing the heroic acts of employees whenever and wherever they may occur.

#### 3-656.1 AWARD NOMINATION

Any employee may nominate another for an award; however, criteria for each award must be strictly observed.

The Award Nomination Form #176 shall be used for all nominations. A Conference Form or supporting documentation (such as Officer/ Correctional Officer of the Quarter nominations) shall be forwarded through the chain of command to the Assistant Sheriff of Administration, who will retain until the Awards Committee meets for subsequent screening and selection. All nominations must be submitted during the calendar year in which the incidents or actions occurred. The individual submitting the nomination shall include the suggested award category on the Award Nomination Form. Award nominations must be submitted as soon as possible after the incident, but no later than thirty (30) days before the annual Awards and Retirement Banquet date.

#### 3-656.2 AWARDS COMMITTEE—ORGANIZATION AND PROCEDURES

The Committee shall consist of the commander/ director or designee from each division, as well as the following personnel:

- The Chairperson of the Awards and Retirement Banquet Committee;
- The President of FOP Lodge 24 or designee;
- The President of the Charles County Correctional Officers Association or designee; and
- Anyone the Assistant Sheriffs appoint to the Committee.

The members of the Committee shall serve at the pleasure of the Assistant Sheriff of Administration. The Committee may conduct business if seven (7) or more members are present. The Assistant Sheriff of Administration will designate the Chairman. The Chairman will only vote in the selection process to break ties.

#### 3-656.3 AWARD SELECTION PROCESS

The Awards Committee Chairman shall convene the Committee as required to efficiently complete its responsibilities. The Committee shall impartially evaluate all nominations and supporting documentation. The Chairman shall record the Committee consensus on the Award Nomination Form #176, affix his signature, and forward to the Assistant Sheriff of Administration.

Copies of all nominations for awards, as well as those receiving awards, will be placed in the respective member's





## Administrative and Operational Manual

September 12, 2022

personnel file.

### 3-656.4 AWARDS CEREMONY AND PRESENTATION

The Awards Ceremony and Presentation will be held yearly with the Retirement Banquet. The purpose of the ceremony is to recognize award recipients and retirees from the previous year.

### 3-656.5 TYPES OF AWARDS

#### Medals of Valor

- **Gold Medal of Valor** (the highest Agency award)
  - The officer performs a courageous act far above and beyond the call of duty;
  - No other recourse for the successful performance of the police service exists;
  - The officer is knowingly and voluntarily exposed to danger;
  - The danger is so extreme that the officer's death or serious injury is a predictable, reasonable expected result.
- **Silver Medal of Valor** (the second highest Agency award)
  - The officer performs a courageous act far above and beyond the call of duty;
  - No other recourse for successful performance of the police service is readily apparent to the officer;
  - The officer is knowingly and voluntarily exposed to danger;
  - The danger is so extreme that the officer's death or serious injury, while not expected, is still a very high possibility.
- **Bronze Medal of Valor** (the third highest Agency award)
  - The officer performs a courageous act beyond that normally expected of a dedicated officer in a similar position;
  - The officer's actions are sound and appropriate;
  - The officer, either through his own actions or those of others, is exposed to an unusually high level of danger;
  - The danger is such that the officer's death or serious injury is a realistic possibility.

#### Heroism Award

This award shall be presented to a citizen who encounters an extraordinary hazard and risks his/her life in performing an act of heroism (life-saving, apprehension of dangerous criminals). The act must be of an extraordinary nature above and beyond the normal expectations of a citizen.

#### Memorial Medal

The Memorial Medal is posthumously awarded to an officer in recognition of the ultimate sacrifice in the line of duty. This medal shall be presented to the family of the officer as a display unit and will not have a corresponding ribbon.

At the discretion of the Sheriff, the Memorial Medal may be awarded to any officer who was killed or dies, accidentally or otherwise. Awarding of the Memorial Medal does not necessarily preclude a posthumous Award of Valor if the appropriate requirements are met.

#### Agency Injury Citation

- An officer has suffered a serious injury inflicted by an armed or dangerous adversary;



## Administrative and Operational Manual

September 12, 2022

- An officer has been seriously injured in an effort to save the life of another, whether successful or not in the attempt;
- Heart attack, communicable disease, or other serious ailment clearly resulting from the direct performance of duty;
- The seriousness of the injury or illness must be substantiated by physical evidence or a reliable witness.

### Meritorious Service Award

The Meritorious Service Award is awarded to any employee or citizen who performs an extraordinary act beyond that which is normally expected. The acts include:

- Attempting to render aid or save the life of a person in which the degree of expected risk is moderate, but is not likely to be life-threatening.
- Demonstrating a high level of expertise, initiative, resourcefulness or dedication in the solution of a crime or the apprehension of an offender.

### Sheriff's Award

The Sheriff's Award is for outstanding achievement reflecting well on the recipient or the Agency. It is associated with administrative career development, general public service, or community relations achievements rather than with patrol or investigative performance. An example would be an employee making a suggestion / recommendation resulting in a measurable monetary savings to the Agency. The Awards Committee may recommend persons for the Sheriff's Award, but the recipients will be selected solely by the Sheriff.

### Life-Saving Award

This award is presented to any employee or citizen who, while on- or off-duty, preserves the life of any person or who rescues someone from a life-threatening environment. Circumstances shall have been such that had the person's actions not been taken, death to the victim certainly or most probably would have resulted.

### Safe Driving Award

The Safe Driving Award is given to recognize those employees who have driven pre-established continuous strings of miles without a preventable collision. Awards are given at 50,000 and 100,000 miles and at every 50,000 miles thereafter.

### Certificate of Commendation

This is awarded to any employee or citizen who performs a remarkable act, not normally expected. The acts include:

- Acts intended to provide aid to an injured person or prevent a person from being harmed. The degree of risk or danger was minimal.
- Acts which lend a high degree of cooperation or assistance in an operational, administrative or community service. This may include an internal, job-related action worthy of recognition, clearance of unusual cases, significant recoveries of stolen property, or discovery of unreported crimes.

### Certificate of Appreciation

This certificate may be awarded to any person, group, or organization who/ which displays exceptional effort and dedication to the Sheriff's Office by providing assistance to help the Agency carry forward its mission to serve the community.



## Administrative and Operational Manual

September 12, 2022

The nomination process for civilian/ non-sworn employees and citizens is identical to the process for police officers.

In highly unusual incidents, civilian/ non-sworn employees and citizens may be awarded a Medal of Valor, with the concurrent approval of the Sheriff and the Awards Committee.

When a civilian/ non-sworn employee who wears civilian attire or a citizen is the recipient of an award, the award will be displayed on an appropriate plaque.

### 3-656.6 AWARDS ACCOUTERMENTS

All Valor Awards will be designated by a gold, silver, or bronze medal with corresponding ribbon. Medals may be worn only on the uniform full dress blouse. The ribbons may be worn either on the blouse or uniform shirt, centered parallel 1/8" above the name plate. When worn, the medals or ribbons will be worn in descending order (Gold, Silver, Bronze, Agency Injury Citation, Merit Award, Sheriff's Award) from left to right as viewed from the front with a maximum of three ribbons per row.

Ribbon awards will be as follows:

- **Gold Medal of Valor**—a gold star centered on a purple and white ribbon;
- **Silver Medal of Valor**—a gold star centered on a blue and white ribbon;
- **Bronze Medal of Valor**—a gold star centered on a red and white ribbon;
- **Agency Injury Citation**—a gold star centered on a purple ribbon;
- **Merit Award**—a gold star centered on a white ribbon;
- **Sheriff's Award**—a gold star centered on a green ribbon;
- **Life-Saving Award**—a gold star centered on a yellow ribbon;
- **Safe-Driving Award**—a gold star centered on a blue ribbon.

### 3-656.7 SUBSEQUENT AWARDS

Only one ribbon will be worn to represent each class of medal received. When a second medal is received, the corresponding ribbon will display a second star. When worn, the star will be positioned to the left of the centered star. A third star will be placed to the left of the second star. A fourth (and fifth) star will be placed to the right of the centered star. A sixth award (for the same medal) will be denoted with an oak leaf cluster, displayed on the left side of the centered star.

### 3-656.8 AWARDS FROM OTHER LAW ENFORCEMENT AGENCIES

On occasion, employees are recognized by allied agencies for acts of valor, meritorious service and/or conduct which brings credit upon the individual, the Agency, and our profession. Consequently, recipients of such recognition may display medals received from other law enforcement agencies, after providing a copy of certification of such awards and subsequent approval of the Sheriff.

- Certificate of award and subsequent approval shall be placed in the member's personnel file;
- Award accouterments shall be worn in compliance with Sections 3-559 and 3-655.10.

### 3-656.9 AWARDS PRESENTED TO THE AGENCY

The Charles County Sheriff's Office frequently receives awards, commendations, and other recognition from allied agencies, community groups and civic organizations. In many cases these awards are presented to individual employees who may be representing the Sheriff and the Agency or who may be the presenter's point of contact with the Agency. Any employee who receives or who presently possesses such items will deliver them to the Charles County Sheriff's Office Media Relations Office. The Media Relations Office will be responsible for maintaining these items for archival and display purposes.



Administrative and Operational Manual

September 12, 2022

### **3-657 AGENCY MEMORIAL**

The Agency has established a memorial on the grounds of the Headquarters building to honor those employees who have been killed in the line of duty, died in the line of duty, served as Sheriff, retired after being required to do so because of an on-duty injury or disease, or who have retired from the Agency after significant service.

#### **3-657.1 DESCRIPTION OF THE MEMORIAL**

The Memorial consists of granite panels for the names of employees. The Agency Logo is in the foreground of these panels. There is a walkway to the Memorial with benches for rest and reflection and landscaping to supplement the beauty of the overall design. The walkway consists of bricks and tiles engraved with names of those, or at the request of those, who contributed to the construction of the Memorial.

#### **3-657.2 MEMORIAL COMMITTEE**

The Memorial Committee is made up of current Agency employees who have been appointed by the Assistant Sheriff of Administration to serve in this capacity. The Committee Chairman is appointed by the Assistant Sheriff and makes recommendations, within the scope of the Committee's purpose, to the Sheriff, through the Assistant Sheriff, for approval and authority to act.

The Committee shall include at least six and not more than ten members. An attempt will be made by the Assistant Sheriff to include representation from all segments of the Agency, to include sworn, correctional, and civilian employees. In all matters before the Committee which require a vote of the members, the Chairman will vote only when necessary to break a tie vote.

The Assistant Sheriff of Administration is the appointing and removing authority for membership on the Committee. All appointments to and removals from the Committee, including the position of Chairman of the Committee, will be made by memorandum from the Assistant Sheriff.

#### **3-657.3 RESPONSIBILITIES OF THE COMMITTEE**

The Committee meets at the pleasure of the Committee Chairman to consider matters pertaining to the Memorial and the names to be engraved on it. Generally, it should be clear from the contents of this policy the names which should be placed upon the Memorial. However, an employee, retired employee, or other person on behalf of one of these, may make application to the Committee to clarify issues pertaining to names placed on the Memorial.

Application shall be in the form of a letter or memorandum addressed to the Chairman of the Committee. The Committee, upon majority vote, shall decide the proper response to all applications. With the approval of the Sheriff, the Committee Chairman will respond to the person making application with the decision.

The Committee shall be responsible for oversight of all care, maintenance, and expansion of the Memorial. It is anticipated that some future expansion will be necessary to support the addition of names of retirees as that group continues to grow. The Committee will explore various options of accomplishing this need.

#### **3-657.4 MINIMUM SERVICE TIME**

The minimum service time as an employee of the Charles County Sheriff's Office in order to normally qualify to be included as a retiree is at least 20 years of service.

The case of an employee who meets the minimum service time but who has left the Agency on less than favorable terms is subject for review by the Memorial Committee. It will be incumbent upon the employee to petition the Memorial Committee for a meeting to determine eligibility to be placed on the Memorial. The Memorial Committee



**Administrative and Operational Manual**

**September 12, 2022**

will then make a determination of the facts presented and make a written recommendation to the Sheriff regarding the possible inclusion to the Memorial.

**3-657.5 KILLED IN THE LINE OF DUTY**

An employee is to be added to the Memorial panel for “Killed In The Line Of Duty” if that employee is killed or dies as a result of actions taken to fulfill a Sheriff’s Office official responsibility. This action may be taken at a time when the employee is considered on duty, or while off duty, voluntarily performing an activity which can be considered to be a normally expected action in service to the community by any employee of the Agency. The employee’s death in these cases will be the result of some unlawful act, intentionally committed by someone who causes the employee’s death.

Some examples would be that the employee was shot, stabbed, beaten, rundown by a vehicle, or the object of some other force. The employee could also be overcome by some disease or chemical element used by a criminal or terrorist in the furtherance of that person’s aims.

**3-657.6 DIED IN THE LINE OF DUTY**

An employee is considered to have died in the line of duty if that employee suffers an event which immediately, or at a later time, results in the employee’s death. The event which causes or leads to death may occur at a time when the employee is considered on duty, or while off duty, voluntarily performing an activity which can be considered to be a normally expected action, by any employee of the Agency, in service to the community.

Some examples would include a heart attack not precipitated by a struggle or activity involving a criminal or other violator of the law, death as a result of an unintentional motor vehicle collision, natural death as a result of a disease, or physical condition the employee is overcome by.

The placement of a name in the Killed in the Line of Duty or Died in the Line of Duty section of the Memorial may be decided by vote and recommendation of the Committee. Such recommendations will be made to the Sheriff in writing by the Chairman for final approval.

**3-657.7 SHERIFFS OF CHARLES COUNTY**

The names of those persons who are elected to, or appointed by the Governor of Maryland to fill the remainder of a term of, the position of Sheriff of Charles County, Maryland, are to be inscribed in the panel for Sheriff. Persons who act temporarily as acting Sheriff, for whatever period or reason, are not entitled to be placed on the Memorial as Sheriff.

**3-657.8 AGENCY RETIREES**

Employees who have retired from the Charles County Sheriff’s Office may qualify to be placed on the Memorial as retirees if they fall within one of the following qualifying categories:

- Have met the minimum service time requirement; or
- Have been forced to leave employment after suffering an injury in the line of duty or contracting a debilitating disease in the line of duty.

**3-657.9 MULTIPLE NAME APPEARANCE ON THE MEMORIAL**

No employee who otherwise qualifies for appearance on the wall will be placed in more than one place on the wall. An exception is that of a Sheriff who is killed in the line of duty. In this one specific case the Sheriff’s name will be placed on the Sheriffs of Charles County panel and upon the Killed In The Line Of Duty panel. In a case where other employees might otherwise qualify for placement on more than one panel, the employee’s name will be placed

**Administrative and Operational Manual****September 12, 2022**

in the highest place of honor (as determined by the Memorial Committee).

Another exception to this rule might be in the case of an employee who has retired and whose name has been placed upon the Memorial, and subsequently comes back to work for the Agency and is killed in the line of duty. That employee's name may then be also placed on the Killed In The Line Of Duty panel. Such other events that may in the opinion of the Committee require a departure from this policy will be decided by a majority vote of the Committee and, upon approval of the Sheriff, acted upon.

**3-657.10 MAINTENANCE, REPAIR AND EXPANSION OF THE MEMORIAL**

The Chairman of the Memorial Committee will see that the Memorial is maintained in a manner to the credit of all of the employees whose names appear thereon. The Chairman, through the use of the Committee members and otherwise, will arrange for any upkeep necessary beyond that provided by the County Government as a normal part of grounds maintenance.

It is envisioned there will be a future need to expand the Memorial in order to accommodate a growing list of retirees. The Chairman, with the assistance of the Committee and the approval of the Sheriff, will create a plan for the expansion and its funding. Based upon experience over time, the Chairman will ensure the need is met in advance of retirees' panel space being used up.

**3-658 ACTUAL OR POTENTIAL CIVIL SUITS****3-658.1 EMPLOYEE PROTECTION**

The Attorney General's Office and/or insurance carrier provided by the County shall be responsible for protecting the legal interests of Agency members and the Sheriff in any matter involving either actual or potential civil litigation arising out of the performance of the employee's duties.

**3-658.2 LITIGATION AND AGENCY EMPLOYEES**

Employees of the Sheriff's Office must notify the Office of the General Counsel in writing within 24 hours of being served as a court witness or defendant, requesting legal representation for any reason from the Attorney General's Office or the County Attorney's Office, and/or filing a lawsuit.

Any employee of the Sheriff's Office served as a defendant in a lawsuit related to their official duties as a member of the Charles County Sheriff's Office may request appropriate legal representation through the Office of the General Counsel. The employee should attach to the request copies of all court documents received. The request for representation should be made through proper channels in memorandum format on Agency letterhead. The employee should note in the request the date, time, and manner of service. The request for representation will be reviewed by the employee's division commander who will then forward the request to the Office of the General Counsel. The General Counsel will review the request and may forward it to the Attorney General's Office and/or the County Attorney's Office. If a determination is made that the Attorney General's Office will be the representing entity, the employee may need to fill out additional forms as mandated by the Attorney General's Office.

Employees will not make any statements, or otherwise furnish information regarding an incident or allegation of liability against the Sheriff, the Office of the Sheriff or Charles County to anyone outside of the Agency without first notifying an attorney in the Office of the General Counsel, the Attorney General's Office or the appropriate attorney representing the County. Approval must be obtained from the Office of the General Counsel, the Attorney General's Office or the appropriate attorney representing the County to make the statement or to furnish the information.

An employee filing a lawsuit as a plaintiff must provide sufficient written information at the time of notification so that a determination can be made as to whether the cause of action arose during the course of employment.



**Administrative and Operational Manual**

**September 12, 2022**

Employees will not compromise, discharge, or settle any claim arising from the performance of their duties of employment against their personal or property interests, or against the state or county's property or interests, without the consent of the Sheriff, the Attorney General, or the appropriate attorney representing the County.

When an employee is summoned / requested or voluntarily acting to testify, write correspondence, or make statements on behalf of a criminal defendant, the employee will:

- notify his commander and the appropriate prosecutor as soon as possible;
- if no summons is received, advise the person making the request that a summons or subpoena is necessary, unless acting voluntarily;
- not, if acting outside the line-of-duty when testifying or otherwise making statements, make voluntary reference to his position or employment with the Charles County Sheriff's Office.

When an employee is summoned / requested or voluntarily acting to testify, write correspondence, or make statements on behalf of a civil plaintiff or defendant, the employee will:

- notify his commander and the Office of the General Counsel as soon as possible;
- if no summons is received, advise the person making the request that a summons or subpoena is necessary, unless acting voluntarily.
- not, if acting outside the line-of-duty when testifying or otherwise making statements, make voluntary reference to his position or employment with the Charles County Sheriff's Office.

**3-659 CONTRACT SERVICES BENEFITS**

Any employee who provides police services under a contract which the CCSO has entered into with another government entity will be protected and receive the same benefits as if the services were rendered to the CCSO without such a contract in existence.

**3-679 TRAIL AUDITS**

The purpose of trail audits is to assist supervisors in evaluating the performance of their subordinates, to identify potential problem areas and training needs, to monitor an officer who has been identified as a potential problem employee under the Personnel Early Warning System, and to explore ways to improve the quality of service to the community.

To conduct an audit, each supervisor of sworn personnel will choose for review a random sampling of calls for service, assigned cases or other citizen contacts. The supervisor will contact the involved citizen by telephone to conduct the trail audit. Supervisors will conduct at least two trail audits for each non-probationary officer during each quarter. More audits may be conducted as the supervisor deems necessary to assist in evaluating or monitoring an officer. Examples of the types of incidents that qualify for a trail audit include:

- a patrol officer's response to a call for service;
- traffic stops and traffic crashes;
- a detective's handling of an assigned case;
- a Judicial Services officer's handling of a domestic violence case; and
- a COPS officer's response to an assigned problem.

Individuals involved in the following types of incidents should not be contacted for trail audits:

- homicides or suicides;



## Administrative and Operational Manual

September 12, 2022

- sexual assaults;
- child abuse cases; or
- fatal traffic incidents.

Supervisors shall conduct trail audits utilizing the Trail Audit Form #856. If a particular question does not apply to the instant case, it will be marked as not applicable. If the person contacted refuses to answer the questions, "refused" will be written at the bottom of the form. A refusal shall not count as a completed audit. Upon completion, copies of the form will be forwarded by the supervisor through the chain of command to the division commander. If the trail audit is being used to monitor an officer as part of the Personnel Early Warning System, a copy of the audit will be forwarded to Human Resources and/or the Commander, OPR. The original will be maintained by the supervisor for use in completing the officer's evaluation.

Supervisors may review the results of trail audits with subordinates in order to provide immediate positive or negative feedback regarding the performance of their duties.

### 3-680 PERSONNEL EARLY WARNING SYSTEM

The purpose of this order is to establish policy and procedures for identifying employees who may be experiencing difficulties in the workplace and to provide resources to assist the employee at the earliest stages of a problem.

Additionally, a comprehensive Personnel Early Warning System is an essential component of good discipline in a well-managed law enforcement agency. The early identification of potential problem employees and a menu of remedial actions can increase Agency accountability and offer employees assistance in correcting a problem.

The system can help reduce instances of the Agency and the employee being faced with investigations of serious cases of misconduct, only to find that there was an escalating pattern of less serious misconduct which could have been abated through earlier intervention. To unnecessarily lose an employee from the profession because no measures to detect and assist employees with problems or to correct and/or improve work performance were taken is devastating, not only to the employee, but also to the Agency and the community.

Employees are the most important and crucial resource of the Agency. Supervisors will make every effort to identify employees who have issues that negatively impact their ability to effectively do their jobs and will make every effort to help employees to resolve such issues in an appropriate manner, consistent with Agency policy and procedures.

This policy will be administered through Human Resources and, in those cases involving potential disciplinary problems, coordinated with the Commander, OPR.

#### 3-680.1 FIRST LINE SUPERVISOR RESPONSIBILITIES

**First Line Review** - First line supervisors must be attuned to potential problems that may negatively affect an employee's work performance. Supervisors, in addition to day-to-day contact and observation, will evaluate regularly collected material as indicators to determine whether there is a pattern of activity that indicates the existence of a problem. These regularly collected materials may include, but are not limited to:

- performance evaluations;
- citizen complaints;
- work attendance / leave records;
- trail audits;
- disciplinary actions;
- use of force incidents; and
- preventable Agency vehicle crashes.

A supervisor shall take immediate appropriate action, consistent with Agency policies and procedures, whenever the supervisor directly observes inappropriate employee conduct.





## Administrative and Operational Manual

September 12, 2022

When a supervisor becomes aware of a pattern of behavior that requires intervention efforts beyond informal supervisor / employee counseling, the supervisor will forward a memorandum through the chain of command to the division commander / director. The memorandum shall include:

- details of the pattern of behavior that raised the concern;
- details of any informal intervention efforts already attempted by the supervisor; and
- a list of any other witnesses to the behavior.

### 3-680.2 COMMAND / MANAGEMENT RESPONSIBILITIES

Upon receipt of a memorandum requesting intervention action, the employee's section commander / manager will meet with the supervisor to discuss the perceived problem. The section commander / manager will review all records, reports, and other relevant files. He will interview any witnesses and interview the involved employee to discuss possible courses of action and follow-up. After this review of the matter, the section commander / manager will decide if the supervisor should continue to monitor the problem, should further investigate the problem, or that immediate action needs to be taken.

If the section commander / manager determines that immediate action needs to be taken, he will then meet with the division commander / director to review the matter and determine an appropriate course of action to correct the problem or behavior and make a plan for follow-up. The division commander / director shall consult with Human Resources and, in cases involving potential disciplinary problems, with the Commander, OPR to assist in making a determination as to how best to proceed. Intervention action may include, but is not limited to:

- formal counseling and monitoring;
- remedial training;
- EAP referral;
- referral to the Agency's contract psychological assessment services;
- reassignment; or
- disciplinary action.

After a proposed course of action and follow-up is decided upon, the section commander and supervisor will meet with the employee to further discuss the proposed course of action and the plan for follow-up. A finalized action and follow-up plan will be presented in writing to the employee. The employee will receive a copy and sign a receipt acknowledging acceptance of the terms and conditions.

No action in regard to the Early Warning System is subject to either the grievance or disciplinary process. **Exception:** If the action plan includes any recommended disciplinary action, such action will be taken in accordance with established policy concerning discipline.

At the conclusion of this meeting the section commander / manager will forward the finalized action plan, along with a cover memorandum, that details how the action plan and follow-up will be accomplished to the division commander / director.

The division commander / director will forward a memorandum detailing the problem, the proposed course of action, and the follow-up plan along with the finalized action plan to Human Resources, and/or the Commander, OPR and to the Assistant Sheriffs and Sheriff. Follow-up reports or other related documents will also be forwarded as they become available.

### 3-680.3 FOLLOW-UP ACTIONS

The employee's section commander / manager will conduct monthly follow-ups by meeting with the employee and the employee's supervisor for a minimum of three months following the initial meeting. The section commander /



**Administrative and Operational Manual**

**September 12, 2022**

manager, after each such meeting, will forward a memorandum detailing the progress being made toward a solution of the problem to the division commander / director, Commander / Director, Administrative Services, and/or Commander, OPR and to the Assistant Sheriffs and Sheriff. At the conclusion of the three-month follow-up period, the section commander / manager will prepare a final memorandum in which he will evaluate the results and recommend whether to conclude or continue the action plan and follow-up.

**3-680.4 HUMAN RESOURCES / OPR RESPONSIBILITIES**

The Commander / Director, Administrative Services shall be responsible for coordinating all intervention services both within and outside of the Agency, for tracking follow-ups and for maintaining all documents and correspondence relating to these matters in the involved employee's personnel file.

The Commander / Director, in conjunction with the Commander, OPR will ensure a review and evaluation of the Personnel Early Warning System is conducted on an annual basis to determine the effectiveness of the system. All initial and follow-up reports will be reviewed, and input and commentary will be solicited from those employees who have been involved in the system during the previous year. This information will be evaluated and used, if needed, to revise the system in order to make it more responsive to the needs of the employee and the Agency. This review will take place each February and a written report will be prepared by the Commander / Director, Administrative Services and forwarded through the chain of command to the Sheriff in March. In addition, copies will be provided to all affected members of the Executive Command Staff.

**3-700 ORGANIZATIONAL DISCIPLINE**

As an Agency, we are committed to our collective integrity; such integrity is dependent upon the personal conduct, integrity, discipline, accountability, and responsibility of each employee. The Charles County Sheriff's Office holds these values in high esteem, and through fairness and objectivity, has created Agency guidelines. When employees do not perform or behave in a manner consistent with Agency philosophies, expectations, and guidelines, their behavior should be addressed through the disciplinary process.

The Charles County Sheriff's Office is committed to a progressive disciplinary process. The focus of the disciplinary process is corrective action through individual employee responsibility and accountability.

Remedial discipline, such as problem solving and behavior changes, should be the primary emphasis while punitive discipline is secondary. Punitive discipline shall be for cause and shall follow the basic concepts of due process.

The Agency is committed to maintaining an effective internal disciplinary and citizen complaint system. Such a system maintains high professional standards and improves morale by establishing a fair and thorough means to process complaints, while eliminating arbitrary disciplinary applications.

The Charles County Sheriff's Office does not discriminate in any manner against current members, potential members, or member groups on the basis of race, color, religion, sex, age, national origin, marital status, sexual orientation, gender identity, genetic information, or disability unrelated in nature and extent so as to reasonably preclude the performance of employment.

**3-700.1 AUTHORITY AND RESPONSIBILITY**

The Sheriff, as the elected State Constitutional Officer responsible for the Agency, is empowered to initiate and/or administer discipline within this Agency and to authorize subordinate supervisory personnel to initiate, administer, or recommend disciplinary action. Complaints filed by members of the public against sworn police officers are controlled by the Police Accountability and Discipline Act, Title 3, Subtitle 100, of the Public Safety Article.

The Commander of the Office of Professional Responsibility (OPR) is hereby specifically assigned and delegated the responsibility to oversee and administer the disciplinary process within the Charles County Sheriff's Office. In this regard, the Commander, OPR may report directly to the Sheriff. Any officer assigned to the OPR will assist the

**Administrative and Operational Manual****September 12, 2022**

Commander in this assignment and will have the authority of the Commander when acting on his behalf. Any supervisor, when accomplishing the discipline requirements of this section, is acting on behalf of the Commander, OPR and in such matters has the authority to require employees to give truthful and accurate statements.

**3-700.1.1 SUPERVISORY ROLES**

First line supervision begins with the rank of Sergeant. Sergeants have the best opportunity to observe the conduct and appearance of officers and detect those instances when disciplinary actions are warranted. Internal complaints will be investigated by officers at least the rank of Sergeant. The Sergeant responsible for the investigation will have the authority to conduct the investigation and make recommendations as to the disposition of the case. Sergeants also have the authority to recommend remedial training and to conduct counseling with subordinate officers. In the case of the Disciplinary Disposition Report (DDR), Sergeants have the authority to issue the DDR to sworn non-probationary officers once the disciplinary disposition has been reviewed and approved by their division commander / director and the Commander, Office of Professional Responsibility (OPR).

Lieutenants have the same authorities as Sergeants and may also investigate internal complaints against Agency employees. Lieutenants may also carry out the service of administrative charges on officers under their command.

Captains and directors have the same authorities as Sergeants and Lieutenants, and they will be involved in the review and recommendation phase of the final disposition of cases. Captains will confer with the Commander, OPR prior to the issuing of any final dispositions which are related to internal investigations. Captains will normally carry out the service of administrative charges on officers under their commands. Captains are also delegated by the Sheriff with the authority to terminate officers if the situation warrants. All terminations must be coordinated with Human Resources (civilian employees and probationary sworn officers), the Commander, OPR, and General Counsel. The Assistant Sheriffs will be notified of all terminations.

Any superior of the employee, the rank of Sergeant or above (or equivalent supervisor) may initiate an emergency suspension.

Commanders have the ultimate responsibility of ensuring the integrity and reputation of the CCSO through fair and equitable investigations of internal matters and application of disciplinary procedures where warranted. Commanders must be sensitive to the concerns of the complainant and the needs of the employee throughout the investigative process.

Employees are responsible for complying with CCSO guidelines including all additions and amendments that may be promulgated and with all other orders and directives, either verbal or written, which may be issued by competent authority. Ignorance of the guidelines, procedures, and orders of the CCSO is not justification for any violation. Further, employees are responsible and accountable for their own actions or failure to act and may not transfer the responsibility for executing or failing to execute any lawful order or police duty.

**3-700.2 CONFIDENTIALITY**

All information and material pertaining to internal investigations and disciplinary actions is considered confidential. Only those persons involved in the investigation, or some other formal activity of the instant case, are permitted access to information concerning that case, and then only to the degree that there is a legitimate need to know such information. Any person who obtains, seeks to obtain, or distributes confidential information or material, or fails to take reasonable measures required to guard the security of information and materials, as required by this section, is subject to disciplinary action up to and including dismissal.

Any requests for information about an internal investigation by a member of the public through a public information act request must be forwarded to the Records division. Records will notify the Office of Professional Responsibility and the Office of General Counsel of the request.

**3-700.3 DEFINITIONS**



## Administrative and Operational Manual

September 12, 2022

**Administrative Charging Committee:** The designated entity as part of the Charles County Police Accountability Board process to review complaints made by a member of the public and issue administrative charges.

**Administrative Hearing Board:** A hearing board convened to decide allegations of misconduct by correctional or sworn officers other than a complaint made by a member of the public.

**Charles County Trial Board:** A hearing board convened to decide allegations of police misconduct.

**Complaint of Misconduct Involving a Member of the Public:** A complaint of police misconduct involving a member of the public and a police officer either received directly by the Agency or referred to the Agency by the Charles County Police Accountability Board. A complaint made by a member of the public must include: 1) the name of the officer accused of misconduct; 2) a description of the facts on which the complaint is based; and 3) contact information of the complainant or a person filing on behalf of the complainant for investigative follow-up. The complaint need not be notarized.

**False Statement** - Any statement made or given by a person, in response to a question or interrogatory which is part of an inquiry, investigation or proceeding, or a written statement made as part of a report or official document of any kind, when the person making the statement knows the statement, or any material part thereof, to be not true.

**Lawful Order** - any order issued by a superior employee, or relayed from a superior employee by an employee of the same or lesser rank to any subordinate, which is not in violation of any law, ordinance, or any written directive.

**Police Accountability and Discipline Act:** Title 3, Subtitle 100, of the Maryland Code relating to the discipline of officers.

**Police Misconduct:** A pattern, a practice, or conduct by a police officer that includes: 1) depriving persons of rights protected by the constitution or laws of the State or the United States; 2) a violation of a criminal statute; or 3) a violation of Agency standards and practices.

**Respondent** - Any employee who is the subject of an internal inquiry or investigation.

### 3-700.4 COORDINATION OF EFFORTS

In most discipline matters, the immediate supervisor of the employee is the most likely person to investigate the subject matter of the disciplinary action and is also the most likely person to recommend the proper action needed. In cases where there is possible criminal activity on the part of the subject employee, or the nature of the activities would require an investigation of a magnitude greater than could be reasonably accomplished by the supervisor, the OPR will assume the major responsibility for the completion of the investigation and the recommendation of disciplinary action.

In any case, disciplinary activities will be coordinated through the OPR. Before beginning an investigation, unless exigent circumstances require immediate action, a supervisor will contact the OPR and obtain a case control number. The supervisor will supply the OPR with the name of the respondent employee, the nature of the probable offense(s) or complaint(s), the name of any complainant(s) (this could be the supervisor), the date, time (or a range of dates or times), place(s) of occurrence, and the name of the investigating supervisor.

For the purposes of taking statements from respondent employees, the investigating supervisor is empowered to place the employee under duress and require a statement. Employees who refuse to make a statement after being ordered to do so are subject to additional disciplinary action for insubordination in the matter of refusing to make a statement. Correctional officers are entitled to the protections outlined in the Charles County Correctional Officer Bill of Rights. Absent exigent circumstances, civilian and sworn personnel should be given a reasonable opportunity to consult with an attorney and have an attorney present.

Supervisors should be mindful duress statements are of value only in administrative cases. If criminal activity is

**Administrative and Operational Manual****September 12, 2022**

involved in the matter under investigation, no duress statement should initially be taken. All cases involving criminal or possible criminal activities will be referred to the OPR for investigation. The OPR Commander will make a determination concerning the advisability of taking duress statements from any of the persons involved in a case where criminal activities are the focus. Duress statements should not be taken from persons against whom criminal charges are possible, unless the Commander, OPR or his designee has been consulted. Any statement from such persons, other than duress statements, will be handled in the same manner as are statements in any normal criminal investigation.

Supervisors are not permitted to present final punitive action recommendations unless approved by the Commander, OPR. They may, however, make recommendations to their division commander/ director, regarding appropriate punitive action in a given case.

**3-701 OFFICE OF PROFESSIONAL RESPONSIBILITY**

The Commander, OPR is charged with overseeing the disciplinary process within the Agency. As the Commander responsible for all investigations of Agency employees, the Commander, OPR is responsible for assuring the fair and equitable administration of discipline, to include progressive discipline and equal punishment for equal infractions. The Commander is charged with maintaining files, records, and a personal awareness of all disciplinary matters. This includes the responsibility for:

- supervising the Internal Affairs Section;
- briefing the Sheriff or his designee of any alleged serious misconduct or patterns of misconduct occurring within the Agency;
- issuing Internal Affairs case numbers to track all complaints and sending a letter acknowledging that the complaint has been received for processing to the complainant;
- an awareness and review of all current Internal Affairs cases;
- knowledge of the past history of discipline within the Agency;
- an awareness of current legal developments regarding the disciplinary process;
- maintaining the security and confidentiality of all disciplinary and investigatory records;
- establishing and coordinating administrative hearing boards;
- preparing and presenting, in conjunction with the Agency General Counsel, the Agency's case during administrative hearing procedures;
- providing for the notification and summoning of witnesses in administrative hearing procedures;
- the maintenance of a current photograph of each employee which would be suitable for a photographic lineup;
- the maintenance of statistical data relating to complaints and employee misconduct;
- the continuous appraisal of trends in employee misconduct to the end that policies and procedures are modified and training programs are created to rectify such trends;
- ensuring that complainants are notified in writing the results of the investigation upon the conclusion of the case;
- the management and administration of the Agency's drug testing policy;

**Administrative and Operational Manual****September 12, 2022**

- Providing completed investigations of complaints of police misconduct to the County Administrative Charging Committee.

The Commander, OPR is authorized to use any of the resources of the Agency in carrying forward these responsibilities. Division commanders/ directors will assign such personnel as are needed to aid in any internal investigation. Commanders/ directors conducting parts of such investigations will consult with the Commander, OPR and keep him informed concerning their part of any investigation.

**3-701.1 INTERNAL AFFAIRS SECTION RESPONSIBILITIES**

The Commander, OPR or his designee will review all complaints received by the OPR. When appropriate, the complaint will be assigned to an Internal Affairs investigator for investigation. The Unit's responsibilities include, but are not limited to:

- investigating allegations of graft, corruption, and serious misconduct by Agency employee(s);
- participating with CID in the investigation of all complaints of criminal misconduct by Agency employee(s);
- investigating police shootings when an officer intentionally discharges a firearm and wounds or fatally injures another person. In such cases, Internal Affairs monitors the CID investigation and addresses the administrative aspects of the shootings. Internal Affairs is not responsible for investigating the primary offense that led to a firearm discharge by an officer. The investigation of the primary incident remains the responsibility of the appropriate specialized unit. For example, if the officer responds to a citizen armed robbery and intentionally discharges his or her firearm at a suspect who is not injured, the robbery shall be investigated by CID;
- participating with CID in the investigation of all cases in which employee actions result in the death of another person, or such serious injuries as are likely to cause death;
- conducting other inquiries as directed by the Sheriff and Commander, Office of Professional Responsibility. Such investigations may not be limited to Agency employees.

Internal Affairs investigations will be conducted in accordance with the guidelines set forth in the Handbook for Conducting Internal Affairs Investigations. The Handbook is a written directive, and employees are required to comply with the contents. Any recommended changes are to be forwarded to the Commander, OPR.

The Sheriff agrees to publish, on a quarterly basis on the Agency Intranet, a synopsis of Internal Affairs investigations concluded during the quarter. The synopsis shall include the officers' ranks, violations, findings, and dispositions (including any penalties). The officers' names will not be identified by publication (per MOU).

**3-702 CITIZEN COMPLAINTS**

The complaint process should be viewed as one of building confidence and credibility between the Agency and its citizens. Many complaints can be traced to a misunderstanding between the persons involved. Therefore, each complaint represents an opportunity for the Sheriff's Office to build or solidify its relationship with the citizens it serves. To assist in educating the public regarding the complaint process, the Procedures for Initiating a Commendation or Complaint Brochure, Form #394, will be available at all Sheriff's Office facilities, public libraries, the Sheriff's Office website, and the County Government Building. The Charles County Sheriff's Office shall strive to ensure the highest level of integrity is achieved and maintained by properly receiving and investigating all complaints against the Agency or its members, including anonymous complaints, in a thorough, fair, and expeditious manner.

A complaint may be a result of:



Administrative and Operational Manual

September 12, 2022

- a violation of Agency rules, policies, or procedures, or of vehicle / criminal law(s);
- other improper action(s) on the part of Agency employees;
- a misunderstanding between an employee and some other person;
- a flawed organizational policy; or
- an unrealistic view held by a citizen of the abilities and/or resources of the Charles County Sheriff's Office and its personnel.

**3-702.1 RECEIVING COMPLAINTS**

Nothing in this policy precludes an employee from listening to a complainant's account of events before a referral is made. However, a complainant should not have to repeat his narrative to several different employees before reaching the correct person to address the complaint. The processing of the initial receipt of citizen complaints should, absent a specific request by the complainant, be handled as follows:

- If received by phone, the receiving employee will obtain the caller's name, a call-back number and, if known, the name of the involved employee(s). The employee taking the call will assure the caller a supervisor or commander will return their call. The employee taking the call will immediately contact the involved employee(s) supervisor, if available, or any available supervisor or command officer to respond to the caller. The contacted supervisor or command officer will contact the complainant promptly.
- If received by mail or electronic correspondence, the receiving employee will immediately forward the letter or email up the chain of command to OPR.
- Walk-in complainants will be immediately referred to the most immediately available on-duty supervisor or command officer. If needed, a supervisor or command officer will be contacted to respond to the location of the complaint. Absent exigent circumstances, a complainant should never be required to go to a different location to report a complaint.
- If a complaint is made in the field, the area patrol supervisor will be notified to respond to the location of the complainant.
- An employee receiving an anonymous complaint will document the receipt, with as much information as possible, in a memo and forward it up the chain of command to OPR.
- Complaints by members of the public may be received by the Police Accountability Board.

**3-702.2 HANDLING CITIZEN COMPLAINTS**

All minor complaints except for complaints of misconduct involving a member of the public and a police officer should be handled at the lowest level possible, preferably by the supervisor of the involved employee. Sometimes a perceived complaint may be a question about police practices or a question or misunderstanding about how an incident was handled. Often complainants just want the opportunity to express themselves, ask questions, and have someone listen to them. Such complaints or inquiries can frequently be handled informally by an employee's supervisor. However, based on the information provided, an inquiry may turn out to be a valid complaint needing further action. Whether a complaint is handled as an inquiry or not will be determined by the nature and seriousness of the complaint and with consideration for how the complainant wants to proceed.

Inquiries not leading to a complaint investigation should generally only be documented within supervisory notes. While each inquiry is unique, supervisors should understand that a pattern of inquiries regarding a particular officer may reveal the need for further supervisory action, possibly including the use of the Personnel Early Warning System, remedial training, or disciplinary action. All complaints not handled as an inquiry are normally to be recorded, either by the complainant or the handling supervisor/ commander on a Complaint Form #145 and, if not handled at the local level, forwarded through the chain of command to OPR.

**Administrative and Operational Manual****September 12, 2022**

If a division commander, upon reviewing a forwarded complaint, deems the allegations require immediate action or that the early involvement of OPR would be beneficial to the investigation, he shall contact the Commander, OPR directly. If the division commander determines, after consulting with the Commander of OPR, the complaint should be handled in the field, he will retain a copy of the Complaint Form and forward the original to OPR for review and control purposes. If retained for field investigation, the division commander will ensure investigation by a supervisor or command officer. OPR reserves the right to assume case responsibility for any complaint.

Whether OPR or the division handles a citizen complaint, the Citizen Complaint Victims' Rights Advocate will send a letter notifying the complainant that the complaint has been received for processing. Within the letter the complainant will be informed of the case number assigned to the complaint, the name of the supervisor or investigator conducting the investigation and that he will be contacted in the near future for follow-up. The letter will also provide information about the investigative, administrative charging committee, and trial board processes.

**3-702.3 FORM OF COMPLAINT**

Complaints not handled as an inquiry should generally be received on the Complaint Form #145 which are available at all Sheriff's Office facilities, on the Agency Website, at public libraries, and the County Government Building. If a citizen asks for a Complaint Form and does not wish to discuss the matter with a supervisor or other employee, the citizen shall be provided a Complaint Form and the brochure "Procedures for Initiating a Commendation or Complaint." If a complainant needs assistance in filing a written complaint, they shall be given assistance in completing the form.

Any letter of complaint, verbal complaints, and anonymous complaints will be received and documented, either on the Complaint Form or, if anonymous or only minimal information is provided, in a memo. All completed forms or memos will be forwarded through the chain of command to OPR.

A formal complaint from a citizen is not a necessary prerequisite for an investigation. If an employee becomes aware of information which would indicate the need for an internal investigation of any personnel or activities of the Agency, the employee shall contact the Commander, OPR who shall initiate the Complaint Form on behalf of, or in place of, a citizen complainant.

**3-703 COMPLAINT INVESTIGATION**

A copy of all documented complaints will be forwarded to OPR for a tracking number and assignment. Complaints not requiring involved investigations, criminal activities, or personnel from several units of the Agency may be assigned for field investigation. The Commander, OPR still retains general oversight of all complaint investigations. The Commander, OPR may retain any case for investigation when the Commander deems it is necessary for the proper resolution of the case.

Regardless of where the investigative responsibility is placed, the complainant will be kept informed of the progress of the case and there will be a formal closure to each investigation. If the case is handled at the division level, the report will be sent to OPR. For complaints of misconduct involving a member of the public, the Commander of OPR will forward the completed report to the County Administrative Charging Committee if the complaint involves a sworn employee.

**3-703.1 COMPLAINTS THAT ARE NOT COMPLAINTS OF MISCONDUCT INVOLVING A MEMBER OF THE PUBLIC**

Anonymous and other complaints that do not meet the definition of a complaint of misconduct involving a member of the public should not be excluded from investigation. Anonymous callers may be referred directly to OPR; however, if after hours, the employee receiving the initial contact will document the complaint and forward that documentation to OPR. Where possible, a preliminary investigation of the substance of the complaint will be made. The investigation of anonymous complaints will be terminated when no additional information can be obtained. The



**Administrative and Operational Manual****September 12, 2022**

case will be documented and the subject employee will be informed of the nature of the complaint and the result of the investigation.

**3-703.2 INTERNAL COMPLAINTS**

Any employee desiring to file a complaint against another employee shall submit a written complaint directly to OPR. The Complaint Form #145 should be used for these complaints. Complaints involving harassment, arbitrary discrimination and/or sexual harassment shall be handled in accordance with procedures outlined elsewhere in the AOM.

**3-703.3 HARASSMENT OF WITNESS**

Harassment of a witness is a serious offense. Any Agency employee who subjects a complainant or witness to harassment shall be subject to appropriate disciplinary action up to and including termination.

**3-704 DISCIPLINE - CORRECTIONAL EMPLOYEES AND SWORN EMPLOYEES FOR COMPLAINTS OTHER THAN COMPLAINTS OF MISCONDUCT INVOLVING A MEMBER OF THE PUBLIC**

The following subsections of this policy apply only to correctional officers of the Charles County Sheriff's Office. These subsections also apply to sworn officers for investigations of complaints other than complaints of misconduct involving a member of the public. They do not apply to probationary law enforcement officers except in cases of alleged police brutality.

Civilians and police communications officers are covered in the second phase of this policy following this section of the Manual.

**REFERENCES:**

Information concerning the Correctional Officers' Bill of Rights is found in the Annotated Code of Maryland. Information concerning disciplinary matters and the Sheriff can be found in 210 of the Code of Charles County, Maryland.

**3-704.1 PROGRESSION OF DISCIPLINE****3-704.1.1 LETTER OF REPRIMAND/ WRITTEN WARNING**

A Letter of Reprimand (Form #633B) is a formal written warning to an employee which will be maintained in the employee's personnel file, and may be utilized for sworn and correctional officers and civilian employees.

- The Letter of Reprimand is considered a formal disciplinary action.
- All Letters of Reprimand must be attached to the Disciplinary Disposition Report (DDR), Form #633 for non-probationary correctional officers, and #633A for probationary correctional, and reviewed by the employee's division commander/ director, the Commander, Office of Professional Responsibility or his designee, and the appropriate Assistant Sheriff prior to issuance.
- Unless waived by the employee, the employee shall have the right to receive a copy of the Letter of Reprimand and to respond to the Letter of Reprimand in writing.
- The employee has three (3) working days to respond in writing to the Letter of Reprimand (LOR)/ Disciplinary Disposition Report (DDR). The LOR/ DDR shall be returned to the issuing supervisor.
- If for any reason a sworn or correctional officer does not agree to the Letter of Reprimand recommended



## Administrative and Operational Manual

September 12, 2022

in the DDR, a formal investigation shall be completed and documented, if not already conducted. The Commander, OPR or his designee shall assign an Internal Affairs tracking number to be assigned as a field or internal investigation.

### 3-704.1.2 DISCIPLINARY DISPOSITION REPORT (DDR)

The Disciplinary Disposition Report (DDR), Form #633 for non-probationary sworn and correctional officers, allows disciplinary action including a written reprimand, fines, loss of leave, suspension, and termination. In most cases the Disciplinary Disposition Report (DDR) permits Agency employees to accept punishment for infractions without a formal investigation or interrogation. By using the DDR, a single disciplinary event can be quickly settled with or without a formal investigation when all parties agree.

Incidents involving a recommendation of termination of a non-probationary sworn or correctional officer shall be documented by a formal investigation.

The DDR may be used for the disposition of a final disciplinary action recommended as the result of a formal investigation.

If for any reason a sworn or correctional officer does not agree to the disciplinary action recommended in the DDR, a formal investigation shall be completed and documented, if not already conducted. The Commander, OPR or his designee shall assign an Internal Affairs tracking number to be assigned as a field or Internal Affairs investigation.

In disciplinary situations where a formal investigation has not been conducted, a supervisor, through the chain of command, shall confer with his division commander/ director and the Commander, OPR prior to the DDR being presented to the respondent officer. This shall be done to ensure the proposed discipline is consistent with others who have been charged with similar violations.

Upon completion of the review, the Commander, OPR may decide the DDR is not the appropriate method of handling the allegations, and assign the infraction an Internal Affairs case number to be handled as a formal field or Internal Affairs investigation.

As in all disciplinary situations, supervisors must recommend disciplinary action through the chain of command for approval by the appropriate division commander/ director.

Prior to final service of the DDR, the division commander/ director shall confer with the employee's Assistant Sheriff regarding the allegations and recommended disciplinary action, to include disciplinary recommendations resulting from the Agency Collision Committee.

The Agency reserves the right to increase the proposed punishment if a respondent declines disposition by DDR and an investigation sustains an Agency violation, subject to the procedures of the Police Accountability and Discipline Act.

When completing the DDR, the supervisor must cite the specific rule or other directives violated and briefly describe the violation.

Officers must be informed of the following if they accept the punishment recommended in the DDR:

- They are not disputing the violation occurred;
- They are waiving their rights to an Administrative Hearing Board and their rights under the COBOR, and the AOM; and
- They are accepting the punishment which is imposed by the highest-ranking officer of their respective division.



## Administrative and Operational Manual

September 12, 2022

The proposed punishment must be indicated on the DDR before it is presented to the respondent officer. The DDR shall inform the officer he has three working days to decide whether to accept the disposition. If the officer declines to accept the disposition, or fails to return the form within the specified three working days, he will be advised that if the subsequent investigation sustains the alleged violation, the punishment proposed on the original DDR may be increased.

The Commander, Office of Professional Responsibility (OPR) or his designee shall sit on the Agency's Collision Committee. DDRs issued as a result of a recommendation by the Collision Committee may be issued without further consultation with the Commander, Office of Professional Responsibility. The remainder of the DDR review process, however, shall be followed.

The DDR may serve as an official administrative charging document and satisfies the requirements of COBOR §11-1106. In the event a respondent officer does not accept the disciplinary recommendation presented in the DDR, formal administrative charges may be completed through the Office of the General Counsel.

A correctional officer who does not accept the disciplinary recommendation presented in the DDR may request an Administrative Hearing Board as described in AOM 3-711. A sworn police officer who does not accept the disciplinary recommendation presented in the DDR may select a hearing before a Charles County Trial Board as described in 3-716.

### 3-704.1.3 ADMINISTRATIVE CHARGES

Administrative charges may be initiated in cases involving violations, which could result in discipline more severe than outlined within the DDR. These charges could lead to disciplinary action, up to and inclusive of loss of leave, demotion and termination of employment. Examples would be criminal law violations, excessive use of force, making any false report or statement, and the like. Once approved, the OPR Commander will prepare these charges.

Administrative Charges are considered "filed" for purposes of §11-1106 of the COBOR when signed by the respondent officer's Commander, the commander of OPR, or the Sheriff's designee.

Prior to taking disciplinary action, commanders/ directors will refer to the Disciplinary Matrix contained within this policy. This section categorizes offenses to provide a uniform recommended disciplinary action range. This is intended to provide guidelines only, and the final disciplinary action will be determined on an individual case-by case basis.

Nothing in this section or in the Disciplinary Matrix has the intent or the effect of limiting the Sheriff's authority in determining or rendering the appropriate final disciplinary action.

Prior to disciplinary action being taken, the nature of the violation and recommended disciplinary action shall be forwarded, via the chain of command, to the affected employee's commander / director. The Commander, OPR will ensure the recommended disciplinary actions are administered equitably by researching the employee's history with the Agency and the Agency's history in disposing of similar incidents.

**NOTE:** Should the imposed disciplinary action include any financial obligation incurred by the employee, i.e., fines or training costs, a copy of the disciplinary disposition shall be forwarded to the Accounting Section by the imposing authority.

### 3-704.1.4 FINES VERSUS RESTITUTION

Fines may be imposed as part of the conclusion of a disciplinary case. Restitution, on the other hand, for lost or damaged property is not considered discipline and therefore does not require the procedures outlined within the disciplinary policy. Restitution will never be over 3% of the officer's base salary.



## Administrative and Operational Manual

September 12, 2022

**3-706 DISCIPLINARY MATRIX - SWORN AND CORRECTIONAL OFFICERS****PURPOSE**

Contained in this document is the Maryland Statewide Model Disciplinary Matrix required by the Maryland Police Accountability Act of 2021 (Public Safety Article, 3-105, Annotated Code of Maryland). The Statewide Model Disciplinary Matrix is the required framework through which all matters of discipline will be imposed as a result of a sustained disposition from an administrative investigation into an officer's misconduct. The purpose of this Disciplinary Matrix is to apply disciplinary standards in a fair, equitable and consistent manner statewide.

**GENERAL PROVISIONS**

In order to protect the collective integrity of a law enforcement agency, all matters that may result in discipline shall be imposed pursuant to the Disciplinary Matrix as responsive measures to an officer's sustained violation of an agency's policy or other police misconduct. Generally, each sustained misconduct violation shall be considered separately for the purpose of recommending and imposing discipline. However, when multiple violations arise from the same incident, a determination may be made that the most effective manner to address discipline in the case is to consolidate violations into one form of discipline.

Discipline is imposed for first violations and may follow a progressive course for repeat or increasingly serious offenses. This Disciplinary Matrix, and the imposition of discipline, shall not be based on the member's race, religion, gender expression, gender identity, sex assigned at birth, sexual orientation, national origin, age, ethnicity, or familial relationships. Furthermore, the imposition of discipline shall not be influenced by the high or low profile nature of the incident.

The Matrix includes a breakdown of six (6) different categories of violations, labeled A through F, with A as the lowest level of discipline and F as the highest. Each category is defined, along with example violations. Three penalty levels are included in each category which are based on the number of similar violations in a specified period of time. A disciplinary range is then used for assessing the recommended discipline. Based on aggravating and/or mitigating factors the disciplinary range can increase or decrease upon review of the totality of the circumstances surrounding the sustained violation.

**DEFINITIONS**

**Aggravating Factors** – Conditions or events related to the violation that increase the seriousness of the violation and may increase the degree of penalty as specified in the Matrix below. Examples of aggravating factors include, but are not limited to, the following:

- The officer's prior disciplinary history
- The officer's prior negative work history, including non-disciplinary corrective action
- The officer's rank
- The violation was committed willfully or for personal gain
- The officer's efforts to conceal the violation, or to be untruthful or dishonest
- The officer's failure to cooperate with the investigation into the alleged misconduct
- The violation was retaliatory in nature
- The violation or behavior was motivated by bias against a member or group of a protected class under the State's hate crimes law, (Public Safety Article, §10-304, Annotated Code of Maryland).
- The officer's expressed unwillingness to comply with policy, tactics, or performance standards
- The impact of the violation on the community or the department's ability to carry out its mission
- The degree to which the violation caused or could have caused the loss of life or injury, and
- The degree to which the violation caused loss or damage to public or private property.



## Administrative and Operational Manual

September 12, 2022

Note: Some aggravating factors may in themselves constitute additional violations of policy associated with separate, higher, ranges of discipline. For example, “efforts to conceal” even a minor violation may themselves constitute separate ethics/honesty violations subject to a higher range of discipline (e.g., lying or destroying/falsifying evidence to conceal a minor violation).

**Disciplinary Matrix** – a written, consistent, progressive, and transparent tool or rubric that provides ranges of disciplinary actions for different types of misconduct. (Public Safety Article, §3-101, Annotated Code of Maryland).

**Formal Written Counseling (FWC)** – A form of counseling given to employees who have violated an agency’s policy. Formal Written Counseling, the least severe form of disciplinary action, serves as a warning for violations. Further violations of same or similar conduct may result in more severe discipline. A copy of the formal written counseling shall be placed in the officer’s disciplinary file.

**Letter of Reprimand (LOR)** – A formal letter to an officer from the agency which details the officer’s wrongful actions and states their actions have been deemed inappropriate or unacceptable. Further violations of same or similar conduct may result in more severe discipline. A copy of this letter shall be placed in the officer’s disciplinary file.

**Loss of Leave (LOL)** – Removal of leave from officer’s accrued leave total (vacation, personal). Loss of leave shall be determined in hours.

**Loss of Pay (LOP)** – Suspension from duty without pay.

**Level (One)** – Penalty level for first offense violation.

**Level (Two)** – Penalty level for second offense of similar conduct.

**Level (Three)** – Penalty level for third offense or more of similar conduct.

**Mediation** – A process in which parties in a dispute work with one or more impartial mediators who assist the parties in reaching a voluntary agreement for the resolution of a minor dispute or conflict.

**Mitigating Factors** – Conditions or events that relate to the violation, but do not excuse or justify the violation, that are considered in deciding the degree of penalty. Examples of mitigating factors include, but are not limited to, the following:

- The officer’s actions are attributable to selfless concern for the well-being of others
- The officer’s lack of disciplinary history
- The officer’s complimentary work history
- The officer’s prior positive work history
- The violation was the inadvertent result of reasonable, otherwise compliant performance
- The officer’s prompt acceptance of responsibility for the conduct and willingness to be held accountable
- The officer’s commission of the violation at the direction of a superior (who might also be subject to separate discipline)
- Unusually serious workplace tensions / stressors, and
- The violation is attributable to limitations beyond the control of the officer that are caused by legally protected physical or mental disabilities and/or conditions.

**Penalty Days** – The forfeiture of vacation days and/or the imposition of suspension without pay for a specified period of time. The decision to suspend, deduct vacation days, or impose a combination of both, is based upon the severity of the misconduct along with any relevant aggravating and mitigating factors. The local ACC and/or Agency Head shall define a “day” as a specified number of hours depending on the officer’s schedule and/or unit within the agency.



## Administrative and Operational Manual

September 12, 2022

**Police Misconduct** – Refer to Public Safety Article, §3-101, Annotated Code of Maryland.

**Remedial Training** – Training designed to correct the behavior of officers who have failed to perform their duties with the skill, knowledge and/or ability expected and/or required of them, or have otherwise demonstrated a need for additional training.

## PROCEDURES

**Violation Categories** – The Matrix includes six (6) categories. Each offense is categorized by a letter (A-F) that represents the severity of the offenses in that category. Category A is the lowest level of discipline and Category F is the highest level. Each category is defined along with a list of example misconduct violations that fit into that category.

**Special Circumstance Categories** – Special circumstance categories are specific violations with their own disciplinary ranges.

**Factors Influencing Discipline** – Mitigating and aggravating factors surrounding a violation may increase or decrease the discipline. Those factors will be considered within the disciplinary range for a specific category.

**Multiple Count Adjustments** – Generally, each sustained misconduct violation shall be considered separately for the purpose of recommending and imposing discipline. However, when multiple violations arise from the same incident, a determination may be made that the most effective manner to address discipline in the case is to consolidate violations into one form of discipline. The most serious offense is used as a starting point within a violation category. The other offenses determine whether and how much to increase the discipline within the selected violation category.

**Prior Disciplinary Record - Same Category** – The Matrix incorporates an officer's prior sustained disciplinary record in determining discipline for a new violation. In each category, there are three penalty levels based on the number of misconduct violations within a specified period of time. Three or more sustained violations in the same category and specified time period will progress to the next higher offense category noted in the Matrix.

**Determining Discipline** – In determining discipline, there must first be an agency policy violation or other police misconduct. Once a violation has been identified, review the violation examples found in the Matrix and select the appropriate offense category. If the specific policy/procedure violation is not listed, review the violation category definition, along with similar example violations and select the most appropriate category. Next, determine if the offense is a first offense or repeat offense and select the appropriate level. The disciplinary section is located to the right of the category definition and level. Each chart includes an acceptable disciplinary range for applicable violations. In addition to the severity of the conduct, mitigating or aggravating factors should be considered prior to making a final determination of discipline. The range of discipline includes formal written counseling (least severe), reprimands, penalty days, and termination (most severe).

**Additional Corrective Measures** – Notwithstanding the penalties in the Matrix, an officer may be referred to counseling, an employee assistance program, training, restitution and/or a demotion. Demotions can be considered for Category D and E violations. Additionally, suspension or removal from a take-home car program and suspension or removal from secondary employment are also options for an ACC to consider. These options may also be imposed by police management, independent of the Local Administrative Charging Committee, consistent with management rights and/or agency policy.

**Violations that Fall into Multiple Violation Categories** – Some violations can fall into multiple categories depending on the severity of the violation. For example, penalties for body-worn camera related violations, insubordination, and harassment may carry more or less severe penalties, depending on which category most accurately fits the member's actions.

### Notes:

- PAB/ACCs and Agencies may only deviate from the use of the Matrix when required to do so by court



Administrative and Operational Manual

September 12, 2022

order, consent decree or any other superseding legal authority. The Matrix does not impact police management rights to maintain the order and manage the affairs of an agency in all aspects including, but not limited to, establishing standards of service, transfer or assignment of employees, establishing standards for performance and conduct, and maintaining control and regulation of the use of government equipment and/or property.

- Agencies that operate a formal mediation program are not impacted by this process since it occurs prior to an investigation and is mutually agreed to by both the complainant and officer.

Note: An agency policy violation must first be identified prior to selecting a Violation Category. If the specific policy/procedure violation is not listed in the examples, review the violation category definition, along with similar violations and select the most appropriate category.

**VIOLATION CATEGORY – A**

Categories and Descriptions	Level	Disciplinary Range Mitigating Factors → Aggravating Factors
<b>Category A:</b> Conduct that has or may have a minimal negative impact on operations or professional image of the law enforcement agency.	<b>ONE:</b> 1 <sup>st</sup> Violation	Formal Written Counseling → Letter of Reprimand
	<b>TWO:</b> 2 <sup>nd</sup> Violation in 24 Months	Formal Written Counseling → Up to 1 Day Loss of Leave or Loss of Pay
	<b>THREE:</b> 3 <sup>rd</sup> Violation in 24 Months	GO TO CATEGORY B LEVEL 1

**Policy Violation Examples for Category A**

Note: The below list represents violation examples that may fall into this category. An agency policy violation must first be identified.

Violation associated with improper attire and grooming (uniformed/non-uniformed)
Late for duty assignment
Failure to properly care for agency vehicle, including but not limited to vehicle inspection and maintenance care
Failure of officer to provide identification when required
Failure to comply with traffic stop procedures



Administrative and Operational Manual

September 12, 2022

Loss of agency property (excluding weapon and radio)
Parking Violations

**VIOLATION CATEGORY – B**

Categories and Descriptions	Level	Disciplinary Range	
		Mitigating Factors →	Aggravating Factors
<b>Category B:</b> Conduct that has or may have a negative impact on the operations or professional image of law enforcement agency; or that negatively impacts relationships with other officers, agencies, or the public.	<b>ONE:</b> 1 <sup>st</sup> Violation	Letter of Reprimand →	Up to 2 Days Loss of Leave or Loss of Pay
	<b>TWO:</b> 2 <sup>nd</sup> Violation in 36 Months	1 Day Loss of Leave or Loss of Pay →	Up to 3 Days Loss of Leave or Loss of Pay
	<b>THREE:</b> 3 <sup>rd</sup> Violation in 36 Months	GO TO CATEGORY C LEVEL 1	

<b>Violation Examples for Category B</b>
Note: The below list represents violation examples that may fall into this category. An agency policy violation must first be identified.
Rude, discourteous actions towards the public or other employees to include profanity and/or obscene gestures.
Failure to furnish name, ID number, and assignment
Officer using their official status, name, or photograph to endorse any product or service connected with law enforcement for personal gain without permission from agency
Failure to remain alert and awake on duty
Failure to notify supervisor of the suspension, revocation, or cancellation of driver's license
Unauthorized use or wearing agency issued equipment (or use of agency insignia) while working secondary employment
Failure to make required inspection of agency vehicle for weapons/contraband prior to and after transporting a prisoner
Operating an agency vehicle beyond jurisdictional boundaries without authorization





## Administrative and Operational Manual

September 12, 2022

Altering or modifying agency equipment without approval
Operating an agency vehicle while on sick leave, light duty status, or suspension without authorization
Failure to submit required report
Failure to conduct preliminary and follow-up investigation/reporting
Improper use of Internet or other communications equipment
Working secondary employment without approval
Violation of social media policy
Failure to accept a complaint against an officer
Failure to obey traffic laws – minor, while operating an agency vehicle

**VIOLATION CATEGORY – C**

Categories and Descriptions	Level	Disciplinary Range	
		Mitigating Factors	→ Aggravating Factors
<b>Category C:</b> Conduct that involves a risk to safety or that has or may have a pronounced negative impact on the operations or professional image of the law enforcement agency or a member, or on relationships with other officers, agencies, or the public.	<b>ONE:</b> 1 <sup>st</sup> Violation	2 Days Loss of Leave or Loss of Pay	→ Up to 4 Days Loss of Pay
	<b>TWO:</b> 2 <sup>nd</sup> Violation in 48 Months	3 Days Loss of Pay or 3 Days Loss of Leave	→ Up to 5 Days Loss of Pay
	<b>THREE:</b> 3 <sup>rd</sup> Violation in 48 Months	GO TO CATEGORY D LEVEL 1	

**Violation Examples for Category C**

Note: The below list represents violation examples that may fall into this category.  
An agency policy violation must first be identified.

Failure to notify or report to duty assignment – Absent without leave (AWOL)
Failure to notify agency that officer has become subject of a criminal investigation
Failure to properly secure a firearm
Unauthorized/careless use/handling/display of a weapon
Carrying an unauthorized firearm, ECD or other weapon in a vehicle or on the officer's person, on or off duty



Administrative and Operational Manual

September 12, 2022

---

Discharging of firearm in violation of policy – no injury
Failure to properly search a prisoner incident to arrest
Improper release/escape of a prisoner (no criminal intent)
Unnecessary force/excessive force resulting in unknown injury or minor injury
Failure to document or investigate a physical use of force
Engaged in secondary employment while on sick leave
Unauthorized vehicle pursuit – no injury
Dissemination of confidential information related to a criminal investigation, Criminal Justice Information System (CJIS) or Motor Vehicle Administration (MVA) to unauthorized persons



Administrative and Operational Manual

September 12, 2022

**VIOLATION CATEGORY – D**

Categories and Descriptions	Level	Disciplinary Range Mitigating Factors → Aggravating Factors
<b>Category D:</b> Conduct substantially contrary to the values of the law enforcement agency or that substantially interferes with its mission, operations, or professional image, or that involves a serious risk to officer or public safety, or intentionally violates law enforcement agency policy.	<b>ONE:</b> 1 <sup>st</sup> Violation	5 Days Loss of Pay or 5 Days Loss of Leave → Up to 15 Days Loss of Pay
	<b>TWO:</b> 2 <sup>nd</sup> Violation in 60 Months	10 Days Loss of Pay → Up to 20 Days Loss of Pay
	<b>THREE:</b> 3 <sup>rd</sup> Violation in 60 Months	GO TO CATEGORY E LEVEL 1

Note: Demotion and/or reduction in rank can also be considered as a part of the disciplinary penalty for Category D.

**Violation Examples for Category D**

Note: The below list represents violation examples that may fall into this category. An agency policy violation must first be identified.

- Reporting to work with a measurable amount of alcohol in system (no requirement to be legally intoxicated)
- Failure to provide and/or request needed medical assistance (includes individuals not in custody)
- Failure to notify agency that officer has been charged with a civil or criminal violation, whether by arrest or criminal summons.
- Unauthorized vehicle pursuit – with injury
- Failure to report a firearm or less lethal weapon discharge (includes accidental discharges)
- Failure to report an agency collision



Administrative and Operational Manual

September 12, 2022

**VIOLATION CATEGORY – E**

Categories and Descriptions	Level	Disciplinary Range	
		Mitigating Factors	→ Aggravating Factors
<b>Category E:</b> Conduct that involves misuse of authority, unethical behavior (not involving false reporting or false statements), or an act that could result in an adverse impact on an officer or public safety or to the professionalism of the law enforcement agency or a violation of any misdemeanor.	<b>ONE:</b> 1 <sup>st</sup> Violation	15 Days Loss of Pay	→ 25 Days Loss of Pay up to TERMINATION
	<b>TWO:</b> 2 <sup>nd</sup> Violation in 60 Months	15 Days Loss of Pay	→ 30 Days Loss of Pay up to TERMINATION
	<b>THREE:</b> 3 <sup>rd</sup> Violation in 60 Months	GO TO CATEGORY F LEVEL 1	

Note: Demotion and/or reduction in rank can also be considered as a part of the disciplinary penalty for Category E.

<b>Violation Examples for Category E</b>
Note: The below list represents violation examples that may fall into this category. An agency policy violation must first be identified.
Using official position to avoid consequences of criminal laws and/or incarcerable traffic violations.
Unnecessary force/excessive force resulting in serious injury
Failure to report a use of force
Engaging in acts of retaliation
Discharging of firearm resulting in injury or death, non-criminal intent
Obstructing or hindering a criminal investigation
Obstructing or hindering internal affairs or an administrative investigation
Affiliation with any person or organization known to be involved in criminal activity



Administrative and Operational Manual

September 12, 2022

**VIOLATION CATEGORY – F**

Categories and Descriptions	Level	Disciplinary Range Mitigating Factors → Aggravating Factors
<p><b>Category F:</b> Any violation of law, policy, rule or regulation which: foreseeably results in death or serious bodily injury; or constitutes a willful and wanton disregard of the law enforcement agency's mission, vision and values; or involves any act or omission which demonstrates a serious lack of the integrity, ethics or character related to an employee's fitness to hold their position; or involves egregious misconduct substantially contrary to the standards of conduct reasonably expected, to include those whose sworn duty is to uphold the law; or involves conduct which constitutes the failure to adhere to any condition of employment required or mandated by law, including any 18 U.S.C. § 922(g) (Lautenberg) violations.</p>	<p><b>ONE: ANY VIOLATION</b></p>	<p>TERMINATION</p>



Administrative and Operational Manual

September 12, 2022

**Violation Examples for Category F**

Note: The below list represents violation examples that may fall into this category.  
An agency policy violation must first be identified.

- Truthfulness: Intentionally making any verbal or written false statement during an official investigation or on any official agency document.
- Enforcement and/or detention of individuals based on discriminatory practices
- Engaging in sexual behavior on duty
- Engaging in sexual behavior in an agency vehicle or facility, on or off duty
- Intentional malicious and unjustified use of force resulting in serious bodily injury or death
- Intentional erasing video footage and/or audio transmissions from digital video camera equipment (BWC/In-Car Camera)
- Converting property/evidence for personal use
- Performing secondary employment while on-duty
- Improper use of controlled dangerous substance (CDS), narcotic, or hallucinogen
- Tampering or manufacturing of evidence
- Knowingly participating or joining an organization that advocates, incites, or supports criminal acts or criminal conspiracies or that promotes hatred or discrimination toward racial, religious, ethnic, or other groups or classes of individuals protected by law.

**SPECIAL CIRCUMSTANCE VIOLATIONS**

Categories and Descriptions	Level	Disciplinary Range	
		Mitigating Factors	→ Aggravating Factors
<b>DRIVING UNDER THE INFLUENCE</b>  <b>Category 1:</b> Any <u>off-duty</u> driving under the influence of alcohol and/or drugs which would constitute a violation of law.	<b>ONE:</b> 1 <sup>st</sup> Violation	15 Days Loss of Pay	→ TERMINATION*
	<b>TWO:</b> 2 <sup>nd</sup> Violation	30 Days Loss of Pay	→ TERMINATION*



## Administrative and Operational Manual

September 12, 2022

	<b>THREE:</b> 3 <sup>rd</sup> Violation	TERMINATION*
<b>Category 1a:</b> Any <u>on-duty</u> or off-duty in a departmental vehicle driving under the influence of alcohol and/or drugs which would constitute a violation of law.	<b>ONE:</b> 1 <sup>st</sup> Violation	TERMINATION*

\*Unless prohibited by Executive Order or Government Policy

Categories and Descriptions	Level	Disciplinary Range	
		Mitigating Factors	→ Aggravating Factors
<b>FAILURE TO APPEAR FOR COURT/MVA HEARINGS</b>  <b>Category 2:</b> Intentional or purposeful failure to appear for any properly summoned court appearance which is the result of action taken as a law enforcement officer. This category also includes MVA hearings.  *Resets 1 calendar year from the date of the first violation.	<b>ONE:</b> 2 violations in 1 year	Formal Written Counseling	→ Formal Written Counseling
	<b>TWO:</b> 2 additional violations in 2 years	Formal Written Counseling	→ Up to 2 Days Loss of Leave or Loss of Pay

**DEPARTMENTAL COLLISIONS**

Categories and Descriptions	Level	Disciplinary Range	
		Mitigating Factors	→ Aggravating Factors
<b>DEPARTMENTAL COLLISIONS</b>  <b>Category 1:</b> Minor Damage <sup>1</sup> to Police Vehicle and/or Other Property or	<b>ONE:</b> 1 <sup>st</sup> Violation up to 12 months	Formal Written Counseling	→ Letter of Reprimand



Administrative and Operational Manual

September 12, 2022

<p>Vehicle</p> <p><sup>1</sup>Law Enforcement Agencies may establish a dollar amount as a guideline for determining the level of severity (minor vs major).</p> <p><sup>2</sup>Driver Re-training can be imposed at any level but is mandatory for three or more at-fault departmental collisions.</p>	<p><b>TWO:</b> 2<sup>nd</sup> Violation within 0-24 months</p>	<p>Formal Written Counseling →</p>	<p>Up to 2 Days Loss of Leave or Loss of Pay</p>
	<p><b>THREE<sup>2</sup>:</b> 3<sup>rd</sup> or more Violation within 0-36 months</p>	<p>Letter of Reprimand →</p>	<p>Up to 5 Days Loss of Leave or Loss of Pay</p>
<p><b>Category 2: Major Damage to Police Vehicle and/or Other Property or Vehicle</b></p> <p><sup>1</sup>Law Enforcement Agencies may establish a dollar amount as a guideline for determining the level of severity (minor vs major).</p> <p><sup>2</sup>Driver Re-training can be imposed at any level but is mandatory for three or more at-fault departmental collisions.</p>	<p><b>ONE:</b> 1<sup>st</sup> Violation up to 12 months</p>	<p>Formal Written Counseling →</p>	<p>Up to 1 Day Loss of Leave or Loss of Pay</p>
	<p><b>TWO:</b> 2<sup>nd</sup> Violation within 0-24 months</p>	<p>Letter of Reprimand →</p>	<p>Up to 3 Days Loss of Leave or Loss of Pay</p>
	<p><b>THREE<sup>2</sup>:</b> 3<sup>rd</sup> or more Violation within 0-36 months</p>	<p>Letter of Reprimand →</p>	<p>Up to 10 Days Loss of Leave or Loss of Pay</p>
<p><b>Category 3: Injury to Law Enforcement Personnel and/or Civilian</b></p> <p>If gross negligence or reckless operation of a police vehicle is involved in any collision that results in serious injury or death the disciplinary range will increase up to and including termination.</p>	<p><b>ONE:</b> 1<sup>st</sup> Violation up to 12 months</p>	<p>Formal Written Counseling →</p>	<p>Up to 2 Days Loss of Leave or Loss of Pay</p>
	<p><b>TWO:</b> 2<sup>nd</sup> Violation within 0-24 months</p>	<p>Letter of Reprimand →</p>	<p>Up to 5 Days Loss of Leave or Loss of Pay</p>
	<p><b>THREE<sup>2</sup>:</b> 3<sup>rd</sup> or more Violation within 0-36 months</p>	<p>Letter of Reprimand →</p>	<p>Up to 14 Days Loss of Leave or Loss of Pay</p>





## Administrative and Operational Manual

September 12, 2022

---

## VIOLETION EXAMPLES THAT MAY FALL INTO MULTIPLE VIOLETION CATEGORIES DEPENDING ON THE FACTS OF A CASE

The policy violation examples set forth in this document are not intended to serve as an exhaustive list of prohibitions on officer conduct and activities. Rather, they are intended to be a sampling of policy violations that exist in the majority of law enforcement agencies. Examples of misconduct have been provided in each policy violation category to serve as a guide in determining discipline for officers found to have violated an agency's policy or general orders/procedures. However, while policy examples outlining acceptable and unacceptable conduct for officers is necessary, not every situation can or will be covered explicitly. Below is a listing of policy conduct violations commonly found in law enforcement policies that may not fall into one specific violation category, but may warrant a higher or lower level of discipline based on the severity of the misconduct.

**ABUSE OF POSITION:** Officers conduct, whether on or off duty, where their authority or position is used for financial gain, obtain or grant privileges or favors, avoid consequences of illegal acts for themselves or others, or to barter, solicit or accept any good or services, such as gratuities, gifts, discounts, rewards, loans, or fees, whether for themselves or others.

### **BWC/IN CAR VIDEO/VIDEO RECORDED EQUIPMENT VIOLATIONS**

**CONDUCT UNBECOMING:** Officer conduct, whether on or off duty, that casts doubt on their integrity, honesty, moral judgment, or character; brings discredit to an agency; or impairs the agency's efficient and effective operation.

### **CUSTODIAL RELATED VIOLATIONS (ABUSE, SECURING, TRANSPORTATION, MEDICAL CARE)**

### **DISCRIMINATION AND/OR HARASSMENT TOWARD AN INDIVIDUAL BASED ON RACIAL, RELIGIOUS, ETHNIC, OR OTHER GROUPS OR CLASSES OF INDIVIDUALS PROTECTED BY LAW**

### **DUTY TO INTERVENE/FAILURE TO DEESCALATE**

### **FAILURE OF SUPERVISOR TO PROPERLY MANAGE PERSONNEL AND/OR FOLLOW SUPERVISORY POLICY RESPONSIBILITIES**

**INSUBORDINATION:** Willful failure of an officer to obey a supervisor's lawful orders.

### **VIOLATIONS OF FEDERAL, STATE OR LOCAL LAW**

**WORKPLACE VIOLENCE:** Any act or threat of physical violence, harassment, intimidation, or other threatening disruptive behavior that occurs in the workplace or arises out of the employment relationship.

## **3-708      SUSPENSIONS OF POLICE POWERS/ CORRECTIONAL OFFICER AUTHORITY**

This section provides guidance on suspending an officer's police powers or removing a correctional officer's authority whenever it is in the best interest of the public, an officer, or the Office of the Sheriff.

- An officer ranked Sergeant or above (or equivalent civilian supervisor), or the Commander, OPR, may initiate an emergency suspension.
- Suspensions will take one of three forms: suspension with pay working in an administrative capacity,



Administrative and Operational Manual

September 12, 2022

suspension with pay on administrative leave or suspension without pay.

- The Commander, OPR shall be responsible for convening and administering this hearing on the next available business day or as soon as possible.
- Prior to imposing suspension without pay, approval must first be obtained from the Sheriff or his designee. A sworn officer may be suspended without pay if the Sheriff determines such a suspension is in the best interest of the public. For correctional officers, the suspension may be without pay if the officer is charged with a felony.
- A suspension can be imposed either as a phase in the disciplinary investigation process or as a form of final discipline.
- Suspension before final disposition occurs as either a discretionary suspension or a mandatory suspension. When considering whether to apply discretionary suspension, the suspending supervisor must weigh the gravity of the offense against the officer's continued duty status pending an internal investigation.
- Suspending an officer's police powers or correctional authority before the final disciplinary action is an emergency suspension.
- Suspensions shall be documented on the Notification of Suspension Form #391.
- An emergency suspension without pay of a sworn officer cannot exceed 30 days unless the officer has been charged with:
  - a crime of violence, a felony, or a misdemeanor that carries a statutory penalty of more than two years;
  - A misdemeanor committed in the performance of duties as a police officer; or
  - A misdemeanor involving dishonesty, fraud, theft, or misrepresentation.

In cases where an officer is suspended with pay and on administrative leave or suspended without pay, during weekdays between 0800 and 1600 hours, the suspended officer shall be available to respond to a requested location within approximately one hour. Reasonable consideration will be given for the location of the officer's residence. The suspended officer will contact their division commander at the beginning of each week and apprise them of any appointments or plans for the upcoming week that could make them unavailable to respond within that time frame.

### 3-708.1 DISCIPLINARY SUSPENSIONS

To maintain continuity across agency segments, (sworn, corrections, civilian) suspensions resulting from disciplinary recommendations shall meet the following criteria:

- A suspension day equals 8 hours regardless of the number of hours an employee typically works as a result of their specific duty assignment or schedule.
- Suspension days shall be applied in 8-hour increments. If multiple suspension days are imposed, it is the total number of hours that must be satisfied.
- Employees who work more than an 8-hour day must work or use accrued leave for any hours remaining in their shift.



Administrative and Operational Manual

September 12, 2022

- Employees who work less than an 8-hour day will be required to satisfy any remaining suspension hours as soon as possible as scheduled by their Division Commander/Director. After serving the remaining suspension hours, the employee may work the remainder of their shift or use accrued leave.

**Examples:**

A sworn officer is suspended for 1 day (8 hours) but is assigned to the patrol division where a shift is 10 hours. The officer will be suspended for the first 8 hours and then work the remaining 2 hours or use accrued leave.

A sworn officer is suspended for 2 days (16 hours) but is assigned to the patrol division where a shift is 10 hours. The officer will be suspended for a total of 16 hours. The officer will be suspended for a 10-hour shift and serve the remaining 6 suspension hours as soon as possible as scheduled by their Division Commander. After serving the additional 6 hours, the officer will work the remaining 4 hours of that shift or use accrued leave.

A corrections officer is suspended for 1 day (8 hours) but the regular schedule is 8.5 hours. The officer will be suspended for the first 8 hours and then work the remaining ½ hour or use accrued leave.

A civilian employee is suspended for 1 day (8 hours) but their regular schedule is 7.5 hours with a half hour unpaid lunch break. The civilian will be suspended for their 7.5-hour shift and serve the remaining ½ hour of their suspension as soon as possible as scheduled by their Division Commander/Director. After serving the additional ½ hour of suspension time, the employee will work the remaining hours of that shift or use accrued leave.

**3-708.2 DISCRETIONARY SUSPENSION**

A sworn police or correctional officer may be suspended if it is in the best interest of the public, the officer, or the Agency, for circumstances including but not limited to:

- reporting to work unfit or unprepared for duty;
- unsatisfactory performance;
- conviction of a crime;
- AWOL;
- mishandling, abuse, or theft of County property;
- knowingly giving a false statement;
- misrepresentation of facts;
- violations of written directives;
- consuming alcoholic beverages or being intoxicated on the job;
- immoral or unethical conduct reflecting unfavorably on the Agency;
- membership in any organization advocating the overthrow of the U.S. Government by force or violence;
- accepting gratuities in violation of policy;
- refusing to be examined by an Agency physician when ordered;
- loss of job requirements, driver's license, or ability which prevent an employee from satisfactorily executing job tasks or fulfilling mandated training or certification requirements;
- on- or off-duty conduct detrimental to the performance of required duties.

**3-708.3 MANDATORY SUSPENSION**

A sworn police or correctional officer shall be suspended when:

- charged with a felony in any jurisdiction
- alleged conduct as determined by the Sheriff to warrant suspension



Administrative and Operational Manual

September 12, 2022

### 3-708.4 METHOD OF SUSPENSION

Supervisors will suspend employees with or without pay, in writing, using Notification of Suspension Form #391 and inform them their police power/ correctional authority is suspended. In some cases, an employee may be assigned to administrative duties; however, this will be done in writing and not occur until after the initial suspension hearing for those who qualify for one. In most cases, the suspension will be with pay pending the recommendation at the conclusion of the suspension hearing. Officers can waive their right to a hearing and accept the suspension. The supervisor will collect any agency issued firearms, badge(s) of office, identification card(s), assigned vehicle and keys, and any other sensitive agency property. The supervisor will inventory the collected property and provide a receipt to the suspended employee. The inventory shall be documented on Form #393 Suspension Checklist.

The Notification of Suspension will briefly describe the events that transpired resulting in the suspension of the employee. The notification is not a charging document.

For suspensions due to potential misconduct, the suspending supervisor will:

- Immediately notify the Commander, OPR who will establish a prompt suspension hearing.
- Complete an initial report of the circumstances surrounding the suspension and submit it to the Commander, OPR by 0800 hours on the next business day following the suspension.
- Consult with the Commander, OPR and provide the suspended employee the date, time, and place of the scheduled suspension hearing.

### 3-708.5 SUSPENSION HEARINGS

A sworn police or correctional officer suspended for alleged misconduct may request a suspension hearing, which is a formal administrative process. While not a judicial proceeding, the suspension hearing will follow a structured process and allow the Agency and suspended employee the opportunity to present facts relevant to the suspension. The hearing will be conducted by the Hearing Officer who is a command officer appointed by the Assistant Sheriff and rules on all matters relevant to the suspension. An audio recording record will be kept of the hearing.

The suspension hearing will only be concerned with whether the suspension should continue and the conditions. The suspended officer may be present and represented by counsel if desired, however there is no requirement for either to attend, and the hearing may proceed without the officer or council present.

The suspending supervisor and the Commander, OPR or his designee will attend the suspension hearing. The suspending supervisor will present his/her position. The Hearing Officer will be the final authority concerning the proceedings and decide what testimony, evidence or other information is relevant.

Suspensions will generally be with pay except when in the opinion of the Sheriff, suspension without pay is in the best interest of the public. Should an officer be suspended and circumstances change that warrant a reconsideration to suspension without pay or to suspension with pay, an additional suspension hearing will be held.

The suspension hearing is not a public process and only those persons required for the hearing and presenting testimony are permitted to attend. The proceedings of the suspension hearing are confidential and will be handled as such by all employees.

### 3-708.6 RESPONSIBILITIES OF THE HEARING OFFICER

The Hearing Officer has the responsibility for conducting the suspension hearing and will:

- Hear/ review evidence and information



**Administrative and Operational Manual**

**September 12, 2022**

- Determine if an officer will be placed on administrative leave without duties or if the employee will be maintained in a modified duty assignment.
- Immediately prepare a written report of the findings and deliver it to the Sheriff and the division commander/director of the suspended officer.

### **3-709 EXCESSIVE FORCE COMPLAINTS - CORRECTIONS**

All excessive force complaints will be handled in accordance with the Correctional Officers' Bill of Rights (COBOR).

### **3-710 ARREST OF EMPLOYEES**

Any employee arrested and/or charged with a crime or serious traffic violation which mandates a court appearance, or served with a warrant, criminal summons, statement of charges, criminal information or indictment naming the employee as a defendant, will immediately notify his supervisor/ commander. This notification will also be required of an employee who is aware a warrant or criminal summons is on file, but has not yet been served.

The supervisor/ commander receiving such notice will immediately notify his Assistant Sheriff, Sheriff, and Commander, OPR.

In the event an employee of this Agency becomes the recipient of criminal charges, whether by warrant or summons, an immediate investigation shall be initiated. This investigation shall be conducted by the OPR.

### **3-711 ADMINISTRATIVE HEARING BOARD (AHB)**

The Administrative Hearing Board (AHB) is convened at the direction of the Sheriff. The AHB process described here only applies to correctional officers entitled to the protections of COBOR. The AHB conducts hearings of charges against employees and presents a finding of facts to the Sheriff. The AHB is an administrative process where the rules of evidence need not be as strictly adhered to as in a court of law. Evidence with probative value that is commonly accepted by reasonable and prudent individuals in the conduct of their affairs is admissible and shall be given probative effect. However, the AHB is a quasi-judicial proceeding and should be conducted with adherence to the established guidelines within this policy, COBOR and with an atmosphere affording a degree of formality.

Administrative Hearings shall be audio recorded and open to the public, unless the Sheriff finds a hearing must be closed for good cause, including to protect:

- a confidential informant;
- an undercover officer; or
- a child witness.

AHBs will normally be scheduled for Monday through Friday business hours, but may occur on a weekend or be extended to such other hours as are necessary in the opinion of the chairman. All disciplinary matters shall be presented to an AHB unless the employee and the employer agree on the disposition, and the employee waives this process.

#### **3-711.1 OFFICE OF PROFESSIONAL RESPONSIBILITY (OPR)**

The Commander, OPR or his designee will schedule and manage all logistics associated with the AHB. These duties include:

- coordination with the Agency General Counsel as needed to present the Sheriff's Office case;



**Administrative and Operational Manual**

**September 12, 2022**

- making records, investigative reports, and evidence available to the General Counsel;
- preparation of the AHB location to allow members of the public to view the proceedings in person when appropriate, and/or through audio / video conferencing;
- the notification of prosecution witnesses and members of the AHB of the time, date, and location of the AHB;
- on written request by the Respondent or his attorney, notify Agency defense witnesses utilizing the same methods used to notify prosecution witnesses, provided the request is made no less than ten days prior to the hearing;
- monitor the selection process of the AHB, including the process of selection of the member of equal rank;
- provide for clerical assistance to the AHB; and
- such other actions as may be necessary to ensure the proper conduct of the AHB proceedings.

**3-711.1.1 INFORMATION TECHNOLOGY DIVISION**

The Director, Information Technology Division will post the public notification of all Administrative Hearings on the Agency Internet website [www.ccsso.us](http://www.ccsso.us), as soon as possible prior to the hearing, including:

- Internal Affairs Case Number;
- date, time, and hearing location;
- time and location of alleged incident;
- summary of the allegations;
- any applicable rules to the attending or viewing public, including:
  - the public will not be permitted to audio / video tape proceedings;
  - the public shall be excluded if sensitive or privileged evidence and/or testimony is offered, or undercover officers are required to testify;
  - any unruly conduct or any attempt to disrupt the hearing shall be grounds for removal;
  - limited number of persons allowed into the hearing, etc;

**3-711.2 RESPONDENT APPEARANCE AT AHB**

The appearance of the Respondent at the AHB is mandatory. The Respondent's Division Commander or designee shall order the Respondent, in writing, to attend the AHB. Respondents will not be armed upon their arrival for the AHB. The AHB chair is responsible for the security of proceedings.

**3-711.3 REQUIRED ATTENDANCE BEFORE THE AHB**

A notice for an employee to appear before an AHB is a direct order of the Sheriff. Failure to obey such an order is insubordination. Any employee who disobeys this notice to appear and testify specifically, directly, and narrowly to the facts at issue, may be suspended and charged with insubordination.

**3-711.4 CONTINUANCES**

Requests for continuances must be made to the Commander, OPR in writing, no less than 72 hours prior to the beginning of the scheduled start of the hearing. The Commander, OPR may waive this 72-hour requirement in the



Administrative and Operational Manual

September 12, 2022

case of an emergency request.

### **3-711.5 CONSTRUCTION OF THE AHB**

The Sheriff shall convene an AHB composed of at least 3 voting members who are impartial sworn employees with no involvement in the matter pending before the AHB. At least one AHB member shall be of equal rank as the Respondent. One member shall be an officer of the rank of Lieutenant or above who shall act as the AHB chairman.

The Respondent officer may petition the Sheriff to remove any member of the AHB for just cause. The Sheriff shall be the sole judge of the ability of members to serve on the Board. In order for any petition for removal to be considered, it must be presented to the Sheriff within five (5) calendar days of the mailing of notification of the formation of the AHB to the Respondent and/or the Respondent's attorney.

### **3-711.6 DUTIES OF BOARD MEMBERS**

All Board members shall participate in deliberations to determine a verdict and recommendations. In rendering a verdict, a majority opinion of the AHB members shall prevail. The chairman presides over the proceedings and shall:

- describe the reasons for the AHB, under whose authority it is being convened, and the name of the Respondent;
- rule on procedural questions;
- determine the acceptability or relevance of evidence;
- rule on objections raised by either party; and
- notify the Sheriff and the Respondent, in writing, of the AHB's decision, findings, and recommendation.

### **3-711.7 RESPONDENT PRIVILEGES**

The Respondent to an AHB shall be notified by his Division Commander in writing, of the AHB and the charges to be presented no less than ten (10) days prior to the hearing. The Respondent may call defense witnesses and cross-examine opposing witnesses. The Respondent has the right to be represented by counsel of his choosing.

### **3-711.8 WAIVER OF RIGHTS**

A Respondent may ask to waive the AHB and be directly disciplined by the Sheriff. A Respondent officer may waive any other right granted by the COBOR. Any waiver of rights will be granted only upon the written request of the Respondent, presented to the Sheriff in a timely fashion.

### **3-711.9 AHB ORDER OF PRESENTATION AND PROCESSES**

The following order of presentation will be followed when cases are heard by an AHB:

- opening remarks are allowed for the prosecution;
- opening remarks are allowed for the defense;
- the prosecution's case is presented;
- cross examination by the defense is allowed;
- examination by AHB members is allowed;
- the defense case is presented;
- cross examination by the prosecution is allowed;
- examination by AHB members is allowed;



**Administrative and Operational Manual**

**September 12, 2022**

- a summation by the prosecution is allowed;
- a summation by the defense is allowed; and
- a final rebuttal by the prosecution is allowed.

At the conclusion of this process, the AHB members will meet in closed session to deliberate. This meeting will not be a matter of record. The AHB, at the conclusion of its deliberations, will return a finding of guilty or not guilty for each of the charges before the AHB. A finding of not guilty on all charges terminates the action.

If a finding of guilt is made on one or more charges, the AHB shall reconvene the hearing, receive evidence, and consider the Respondent's past performance and other relevant information as factors before making its recommendations to the Sheriff. The AHB will render a verdict and recommendation on each of the charges.

A copy of the decision or order and accompanying findings and conclusions, along with written recommendations for action, shall be delivered or mailed promptly to the Respondent or to his attorney or representative of record, the Office of General Counsel, and to the Commander of the Office of Professional Responsibility (OPR). The Commander of the OPR, using CCSO Form #144, will forward the report through the chain of command to the Sheriff. Upon receipt of the report to the Sheriff, the Sheriff will sign and date the Form #144 indicating receipt of the report.

In determining guilty or not guilty, the standard of proof shall be a preponderance of the evidence.

### **3-712 RECOMMENDATION FOR SUSPENSION**

If the AHB recommends suspension of the officer as part of the final disposition, the officer is not entitled to a hearing as set forth in the section of this policy governing emergency suspension.

#### **3-712.1 RECOMMENDATION FOR TERMINATION**

If the AHB recommends termination of a sworn/ correctional Respondent, the Respondent shall be immediately suspended. The Respondent's police powers/ correctional authority shall be suspended by the Respondent's Division Commander, who shall recover the Respondent's Agency owned firearms, badges, identification cards, and magnetic door access key cards. The recovery of all other Agency property shall be coordinated through the Human Resources Section and the Quartermaster's Office.

The Commander, OPR shall coordinate with Human Resources for a Personnel Order to be transmitted throughout the Agency, concerning the Respondent's status.

### **3-713 FINAL ORDER OF THE SHERIFF**

Written recommendations as to punishment are not binding upon the Sheriff. Within thirty (30) days of receipt of the Hearing Board's recommendations, the Sheriff shall review the findings, conclusions, and recommendations and shall then issue his final order. The Sheriff's final order and decision are binding. Before the Sheriff may increase the recommended penalty of the AHB, he personally shall:

- review the entire record of the Hearing Board proceedings;
- meet with the Respondent and permit the Respondent to be heard on the record;
- disclose and provide to the Respondent in writing, at least ten (10) days prior to the meeting, any oral or written communication, not included in the Hearing Board record, and on which the decision to consider increasing the penalty is based, in whole or in part; and
- state on the record the reason for increasing the recommended penalty.





Administrative and Operational Manual

September 12, 2022

### **3-713.1 EMPLOYEE TERMINATION**

Upon issuance of a final order by the Sheriff that a correctional officer is to be terminated, the Commander, OPR will coordinate with the Commander/ Director, Administrative Services to prepare the termination documents. The Commander/ Director, Administrative Services will ensure that all termination documents are reviewed by General Counsel prior to presenting to the officer. The Deputy Director, Human Resources will notify the Deputy Director, Accounting Section of the pending termination.

Upon approval of the documents by the General Counsel, the Assistant Sheriff of the Respondent will coordinate a meeting with the Respondent and the Respondent's Division Commander. At the meeting, the termination documents will be presented to the officer.

The termination will be finalized in writing, noting the effective date of the termination. The Deputy Director, Human Resources will prepare a Personnel Order to be transmitted throughout the Agency, concerning the Respondent officer's status. Copies of all documents detailing the termination will be placed in the officer's personnel file.

### **3-713.2 APPEAL OF FINAL ORDER**

Correctional officers covered under the COBOR may appeal the decisions of the final order to the Circuit Court of Charles County, Maryland. Any party aggrieved by a decision of a court may appeal to the Court of Special Appeals.

### **3-714 WITNESS FEES**

Witness fees and mileage, if claimed, shall be paid in accordance with the criteria used by the Circuit Court. All requests for witness fees, mileage, and other actual expenses necessarily incurred in securing attendance of witnesses and their testimony shall be itemized and submitted along with receipts and proper documentation to the Agency for payment. The AHB Chairman must validate applications.

### **3-715 EXPUNGEMENT - SWORN/ CORRECTIONAL RESPONDENTS**

Expungement of disciplinary actions and investigations will be accomplished in accordance with the provisions of the COBOR in the Annotated Code of Maryland. Under that section, three years must have elapsed since the final disposition of the action and there must have been a finding of unfounded, unsustainable or exonerated for each and every allegation in the case, or an Administrative Hearing Board acquits, dismisses, or makes a finding of not guilty on each and every charge in the case. If these conditions are met and the officer makes written application to the Sheriff for expungement, the Sheriff may cause the record of the complaint to be expunged.

The Commander, OPR in accordance with COBOR, shall handle expungement requests. No expungement will be made of files where a court action is pending. In instances where one respondent in a multiple respondent case is found not guilty, only references to the respondent who is found not guilty will be deleted from the case file.

Administrative or criminal records relating to alleged police misconduct may not be expunged or destroyed.

### **3-716 INVESTIGATION AND DISCIPLINARY PROCESS FOR COMPLAINTS OF MISCONDUCT INVOLVING A MEMBER OF THE PUBLIC**

This section describes the process to be followed for complaints of misconduct involving a member of the public.

**Action upon Receipt of Complaint Police Misconduct Involving a Member of the Public and a Police Officer.**



**Administrative and Operational Manual**

**September 12, 2022**

Upon receipt of a complaint involving a member of the public, the Commander, OPR, will immediately review the complaint and assign the complaint for investigation.

**Investigation Process**

Unless otherwise stated, investigations involving sworn officers will follow the procedures and restrictions that apply to Correctional Officers under the COBOR.

**Report of Investigation**

The concluded report of investigation will include:

- a description of the evidence relating to the complaint;
- a summary of the investigation including the investigator's recommended findings; and
- the investigator's suggestions for which provisions of the AOM may be involved.

The Commander, OPR, will forward the concluded report and the investigatory file to the Administrative Charging Committee for Charles County (ACC).

**Action by the Administrative Charging Committee for Charles County**

The ACC must review the investigation and make a determination if the officer who is subject of the investigation will be administratively charged or not administratively charged within 30 days of receipt of the investigatory file. The ACC may ask for further investigation.

The ACC may call an officer to appear before it. The officer is entitled to be accompanied by a representative.

If the ACC issues administrative charges, the ACC will recommend discipline in accordance with the Uniform State Disciplinary Matrix.

The ACC will forward its opinion, including any administrative charges and recommended discipline, to the Sheriff, the involved officer, and the complainant.

**Action Following Receipt of ACC Opinion**

The ACC opinion will be distributed to the Chief of Staff, the Assistant Sheriffs, the Office of General Counsel, and the Commanders of OPR and Training.

Within 15 days of receipt of administrative charges against an officer, the Sheriff, through the officer's commanding officer, shall offer discipline to the officer. The Sheriff may increase, but may not decrease, the discipline recommended by the ACC.

The officer must either accept or reject the offered discipline and demand a Board within 5 days. Failure to demand a Charles County Trial Board within 5 days is a waiver of the right to the Trial Board and the Sheriff's offered discipline will be imposed.

**Charles County Trial Board Process**

If an officer demands a hearing before a Charles County Trial Board, the Commander, OPR will coordinate the creation of the trial board with the County Commissioners and the head of the Charles County Police Accountability Board. The Commander, OPR, will be responsible for scheduling the hearing.

The Commander, OPR, with the approval of the Sheriff, will select an officer of equal rank to the involved officer to serve on the trial board.



Administrative and Operational Manual

September 12, 2022

The Office of General Counsel will represent the Agency's interests before the trial board as directed by the Sheriff, which may include presenting evidence and calling witnesses to prove police misconduct occurred.

### **3-717 DISCIPLINARY PROCEDURES - CIVILIAN EMPLOYEES**

All civilian employees are expected to abide by the law, Agency rules, policies and procedures and to efficiently and effectively perform their duties. Whenever an employee fails to do this, measures will be taken to correct the employee's conduct and/or performance. Fair discipline for proper cause, which treats all employees equitably, is an essential element of professional Agency management.

#### **3-717.1 SCOPE OF POLICY**

This policy applies to full-time civilian employees of the Sheriff's Office. For purposes of this policy a civilian employee is defined as any full-time or full-time reduced hours employee other than a sworn law enforcement/correctional officer. The term specifically includes police communications officers. This policy does not apply to probationary, part-time, temporary, emergency or contractual employees. Nor does this policy apply to civilians serving in appointed positions.

Civilian employees may be disciplined for failure to maintain job-related skills, qualifications and certifications, for misconduct, or for unsatisfactory performance of duties and responsibilities.

The role of supervisors is crucial in the disciplinary process. First-line supervisors have the best opportunity to observe the performance, conduct and appearance of employees and detect those instances when disciplinary actions, both positive and negative, are warranted. Employees holding supervisory positions have the authority to conduct counseling and issue oral reprimands to employees within their span of control. They also have the authority to make recommendations to commanders/ directors regarding more severe forms of discipline.

#### **3-717.2 RESTITUTION**

Restitution is the required reimbursement to the Sheriff's Office or the County for loss or damage to Agency or County property.

- Requiring an employee to make restitution to the Sheriff's Office or the County for lost or damaged property is not disciplinary action.
- An employee is not required to pay restitution exceeding three percent (3%) of the employee's annual base pay.
- An employee required to make restitution may also be subject to disciplinary action and/or civil or criminal prosecution.

#### **3-717.3 ABSENT WITHOUT AUTHORIZATION (AWOL)**

An employee who is absent without authorization may be placed in an off-duty status without compensation (LWOP).

- Placing an employee on leave without pay when the employee is absent without approval is not a disciplinary action. An employee who is AWOL may be subject to disciplinary action.
- An employee who is AWOL may also be considered to have abandoned his position, thereby forfeiting any rights to his employment and any protections or rights afforded by the disciplinary process.



Administrative and Operational Manual

September 12, 2022

### 3-717.4 EMERGENCY SUSPENSION

A commander/ director may suspend an employee and require the employee to leave the workplace immediately for engaging in certain conduct (Notification of Suspension Form #391B). Actions which may lead to emergency suspension include, but are not limited to:

- disorderly conduct, fighting or assault;
- being under the influence of illicit drugs or intoxicants, or unauthorized possession of illegal drugs or intoxicants;
- endangering the safety of personnel or causing injury to others;
- malicious damage to Agency property;
- sexual or racial harassment or gross discrimination; and/or
- other acts, activities or omissions which impair the ability of the Agency to fulfill its mission.

Such emergency suspension will be with pay and shall not exceed five days without disposition. Within the five (5) day period, a meeting between the employee, the employee's division commander/ director, the supervising commander if not the division commander/ director, and the Commander/ Director, Administrative Services, will be held.

Emergency suspensions are not subject to the grievance process. However, prior to any loss of pay or other punitive action, an employee will be entitled to the due process set forth within this disciplinary policy.

Upon conclusion of the meeting with the employee, the division commander/ director, with concurrence from the Commander/ Director, Administrative Services, will:

- return the employee to work with no further action; or
- charge the employee and inform him of the proposed disciplinary action and return him to work; or
- continue the employee on suspension with pay pending further investigation and disposition; or
- place the employee on suspension without pay pending further investigation and disposition.

Copies of documents detailing any suspension must be submitted to the Commander/ Director, Administrative Services to be placed in the employee's personnel file.

### 3-717.5 MISCONDUCT

Certain actions are cause for discipline. They include, but are not limited to:

- negligence in the performance of duties;
- incompetent or inefficient performance of duties;
- intentional misconduct without justification which:
  - injures another person;
  - causes damage to property; or
  - threatens the safety of the workplace.
- conduct which has brought or could bring the Agency into disrepute;
- being unjustifiably offensive toward the public, prisoners or fellow employees;



Administrative and Operational Manual

September 12, 2022

- 
- theft;
  - following notification to cease, continuing to engage in another business, trade or occupation which conflicts with the employee's position or prevents the employee from satisfactorily performing the duties of his position;
  - conduct involving dishonesty, fraud, deceit, misrepresentation or illegality;
  - causing damage to public property or wasting public supplies through negligence, recklessness or willful conduct;
  - willfully making a false official statement or report;
  - engaging in or knowingly assisting another in conduct which is a violation of the Agency Administrative and Operational Manual or any other lawful Agency policy;
  - violations of federal, state or local laws;
  - disobeying or failing to obey a lawful order given by a superior, or engaging in other conduct which amounts to insubordination;
  - sexual harassment;
  - engaging in unlawful discrimination;
  - using leave contrary to law or policy;
  - excessive or unexcused absenteeism;
  - misuse of confidential information;
  - using, threatening, or attempting to use political influence or the influence of any County employee or officer in securing promotion, transfer, leave of absence or increased pay; or
  - committing another act not previously specified when there is a connection between the employee's activities and an identifiable detriment to this Agency.

### **3-717.6 SUPERVISORY/ MANAGEMENT RESPONSIBILITIES**

Upon being notified or becoming aware of alleged misconduct or of an unsatisfactory performance issue involving an employee, a division commander/ director may, depending on the circumstances, conduct a performance review/ investigation of the matter personally, assign a supervisor to conduct an investigation, or request the Office of Professional Responsibility to investigate.

If an allegation of misconduct is of a serious nature for which the employee may be terminated, the division commander/ director or the Commander, OPR will immediately notify the appropriate Assistant Sheriff, the Office of General Counsel and the Chief of Staff. The Assistant Sheriff, the Office of General Counsel, and the Chief of Staff will be kept abreast of the progress and the outcome of the investigation.

In all cases, where a supervisor is reviewing the unsatisfactory performance of an employee or is assigned to investigate an allegation of misconduct, before taking any disciplinary action, the supervisor will:



## Administrative and Operational Manual

September 12, 2022

- meet with the employee to allow the employee to respond to the allegations;
- consider any mitigating circumstances;
- review the employee's personnel history;
- determine the appropriate disciplinary action, if any, to be imposed; and
- Forward, through the chain of command, the results of the investigation along with a recommendation for disciplinary action to the division commander / director.

When the recommendation for discipline is less than termination and is approved by the division commander / director, the investigating supervisor will provide the employee with:

- information about the employee's appeal rights (Employee Grievance Process); and
- the effective date and time of the disciplinary action.

If the employee accepts the disciplinary action, it will take effect after five days. If the employee wishes to appeal the disciplinary action, he must do so in writing within five days and follow the employee grievance process.

### 3-717.7 LEVELS OF DISCIPLINE

The Sheriff's Office agrees with and supports a progressive disciplinary policy. Such a policy includes both non-punitive and punitive measures. Due process protections attach only to punitive measures and will not be afforded when the action taken is a non-punitive corrective measure such as remedial training, oral counseling or formal counseling. The degree of discipline administered will depend on the severity of the offense and the circumstances under which it occurred. Nothing in this policy should be construed as prohibiting or limiting the Sheriff's ability to administer discipline at any level. Disciplinary actions which may be taken include, but are not limited to, the following:

- a Letter of Reprimand / written warning;
- forfeiture of accrued annual leave;
- suspension without pay;
- demotion;
- termination of employment;
- Fine;
- Transfer; and/or
- any other appropriate disciplinary measures.

#### 3-717.7.1 REMEDIAL TRAINING

In the event of minor violations which might be corrected by remedial training, an employee may be required to attend or participate in remedial training. Remedial training is not discipline and is not by its nature punitive and therefore not subject to the grievance process.

#### 3-717.7.2 FORMAL COUNSELING

Formal counseling is a discussion between an employee and his supervisor during which the employee is informed of performance or conduct which is unacceptable. Formal counseling is an instructional communication and not a disciplinary action. Neither formal counseling nor any preceding oral counseling are subject to the grievance process. Formal counseling should not be confused with letters of reprimand/ written warnings. This discussion will be governed by the following:

- Counseling sessions will be documented on an Employee Conference Form #180 which lists:



Administrative and Operational Manual

September 12, 2022

- 
- the actions of the employee;
  - the actions taken by the supervisor to modify the behavior or performance; and
  - employee comments. If none, the employee shall write “none” or “to be submitted” to verify he had the opportunity to make comments.
- A counseling session shall occur as soon as possible following the incident so the employee’s behavior or performance can be discussed and corrected while the incident is fresh in the minds of the employee and the supervisor.
  - If available, the supervisor will also refer to any job observation material which has been previously presented to and signed by the employee.
  - The supervisor and the employee are to discuss the incident so the reason the behavior or performance is considered inappropriate is clear to both.
  - The employee is given the opportunity to state his views and suggest corrective action.
  - At the conclusion of the counseling session, the supervisor will recommend a course of action designed to help the employee improve behavior or performance.
  - An employee may submit a written response to an Employee Conference Form within five (5) days after receipt. The response will be attached to the Employee Conference Form. An employee has no other recourse in response to an Employee Conference Form.
  - The original Employee Conference Form and any response and/or attachments will be forwarded through the supervisor’s chain of command to the Sheriff. Upon the Sheriff’s review, the Executive Office Administrator will send the original to Human Resources and copies to OPR, the employee’s immediate supervisor and the employee.
  - A copy will be retained by the supervisor and may be incorporated into the employee’s evaluation for the time period in which the conduct resulting in the Conference Form occurred.
  - OPR will retain copies of all Employee Conference Forms, and any attached responses/other attachments, indefinitely.
  - If the counseling is ineffective, the supervisor shall proceed to the next appropriate level of discipline.

### 3-717.7.3 LETTER OF REPRIMAND

A Letter of Reprimand (Form #633B) is a formal written warning to an employee which will be maintained in the employee’s personnel file, and may be utilized for sworn and correctional officers and civilian employees.

- The Letter of Reprimand is considered a formal disciplinary action.
- All Letters of Reprimand must be attached to the Disciplinary Disposition Report (DDR), Form #633 for non-probationary sworn and correctional officers, and #633A for probationary sworn and correctional officers and civilian employees and reviewed by the employee’s division commander/ director, the Commander, Office of Professional Responsibility or his designee, and the appropriate Assistant Sheriff prior to issuance.
- Unless waived by the employee, the employee shall have the right to receive a copy of the Letter of Reprimand and to respond to the Letter of Reprimand in writing.



Administrative and Operational Manual

September 12, 2022

- The employee has three (3) working days to respond in writing to the Letter of Reprimand (LOR)/ Disciplinary Disposition Report (DDR). The LOR/ DDR shall be returned to the issuing supervisor.
- Civilian employees who do not agree with the Letter of Reprimand recommended in the DDR will have the recourse to appeal the imposition of punitive disciplinary action through the employee grievance process as outlined in AOM 3-750.

### 3-717.7.4 SUSPENSION WITHOUT PAY

Suspension without pay places an employee involuntarily in a non-duty, non-pay status. It is an extremely severe disciplinary action imposed by a division commander/ director with the concurrence of Human Resources and only when a lesser penalty is inadequate. Where feasible under the circumstances, notice will be given to the employee prior to a suspension, proposing suspension without pay. It will be documented in writing noting the offense, when the offense occurred and the proposed amount of time the employee is to be suspended. It entitles the employee to five (5) workdays (from receipt of notice) to respond. Where feasible, the employee will continue in a work status pending the final decision. If the intended disciplinary action is accepted, the suspension will be documented in writing, noting the amount of time for which the employee will be suspended and the date and time the employee is to report back to work.

Suspended employees will be afforded the opportunity to listen to the charges, respond to them and review the evidence prior to any loss of pay.

Copies of documents detailing the suspension will be submitted to the Human Resources Section to be placed in the employee's personnel record.

### 3-717.7.5 TERMINATION

When a performance review or misconduct investigation results in a recommendation of termination, the division commander/ director shall review the unsatisfactory performance documentation or misconduct investigation and either concur or non-concur. He shall forward the completed investigation and recommendations to the Assistant Sheriffs, Chief of Staff and to the Office of General Counsel.

When a determination is made that an employee should be terminated, the division commander/ director will coordinate with Human Resources to prepare a Personnel Order and other termination documents. Human Resources will ensure that all termination documents are reviewed by the Office of General Counsel prior to presenting to the employee. The Deputy Director, Human Resources will notify the Deputy Director, Accounting Section, of the pending employee termination.

Upon approval of the documents by the Office of General Counsel, the division commander/ director and Human Resources will coordinate a meeting with the employee. At the meeting, the Notification of Disciplinary Action proposing termination will be given to the employee.

If the employee is an eligible non-probationary employee and requests it, the Grievance Review Board Process will be initiated. If the final disciplinary action is accepted without appeal, the termination will be documented in writing, noting the date of termination. Copies of all documents detailing the discharge will be placed in the employee's personnel file.

When a division commander/ director determines that a probationary employee has failed to meet performance standards, no investigation is required. The division commander/ director shall forward a written recommendation for termination of a probationary employee to the Chief of Staff, Assistant Sheriffs and to the Office of General Counsel. When a decision to terminate has been reached, the same sequence of events listed above regarding the presentation of termination documents will be followed. Probationary employees have no right to appeal through





Administrative and Operational Manual

September 12, 2022

the employee grievance process.

In any case where an employee refuses to sign the written Notification of Disciplinary Action, the person presenting the notice will write "refused to sign" in the respondent's signature space. A witness to an employee's refusal to sign a written Notification of a Disciplinary Action must initial the written notice.

### 3-717.7.6 APPEAL OF DISCIPLINARY ACTION

Eligible employees will have the recourse to appeal the imposition of punitive disciplinary action through the Employee Grievance Process. An appeal of the imposition of punitive disciplinary action begins with the procedures described in AOM 3-750.3.2, "Level Two".

An employee who wished to appeal the imposition of punitive disciplinary action must make the request in writing to the Deputy Director, Human Resources, within five (5) days from the date the employee is presented with the Notification of Disciplinary Action.

Non-punitive action outlined within the disciplinary process, including, but not limited to, remedial training and formal counseling is not subject to the grievance process.

### 3-717.7.7 DISCIPLINARY ACTION - CALCULATION OF EFFECTIVE DATE

The supervisory official will record the date and time the Notification of Disciplinary Action is presented to the involved employee. The supervisor will calculate five (5) work days from the date and time of notice and record that date and time on the Notification. The employee shall be advised he has until that date and time to grieve the proposed disciplinary action through the Employee Grievance Process. If no grievance is received by the Deputy Director, Human Resources by the conclusion of the recorded five (5) day period, the proposed disciplinary action will become effective at the conclusion of that period. A grievance received after expiration of the five (5) day period without good cause will not be valid. The Deputy Director, Human Resources has sole discretion as to what constitutes good cause.

Example:

The five (5) day grievance period begins on Friday at 1:00 P.M. The first day (24-hour period) concludes on Monday at 1:00 P.M. Each day would be calculated on the 24-hour basis and in this example the five (5) day period would conclude on the subsequent Friday at 1:00 P.M. If one of the weekdays is an official holiday, the five (5) day period would conclude on the following Monday at 1:00 P.M.

### 3-717.8 EXPUNGEMENT PROCEDURES

Expungement of disciplinary actions and investigations will be accomplished in accordance with the following:

- three years must have elapsed since the final disposition of the action; and
- there must have been a finding of unfounded, unsustainable or exonerated for each and every charge in the case; or
- an Administrative Hearing Board acquitted, dismissed, or made a finding of not guilty.

If these conditions are met and the employee makes written application to the Sheriff for expungement, the Sheriff may cause the record of the complaint to be expunged.

The Commander, OPR shall handle expungement requests. No expungement will be made of files where a court action is pending. In instances where one respondent in a multiple respondent case is found not guilty, only references to the respondent who is found not guilty will be deleted from the case file.



## Administrative and Operational Manual

September 12, 2022

### 3-717.9 NAME CLEARING HEARINGS FOR EMPLOYEES NOT ENTITLED TO THE DISCIPLINE PROCESS

This policy shall serve as notice to Agency employees that a name-clearing hearing is, under certain circumstances, provided for; and it outlines the procedures to be followed for an employee to be able to offer information into his personnel record. These procedures shall be separate and apart from all other disciplinary and grievance procedures and will not serve as an appeal of any disciplinary action or to gain reinstatement.

The procedures outlined in this policy provide for the conduct of a name clearing hearing when an employee not entitled to the discipline process is terminated. To request a hearing, the employee must claim false charges are damaging to the employee's reputation and are included in his personnel file, and that there is a likelihood the information will be made available to prospective employers, thus depriving the employee of the freedom to take advantage of other employment opportunities.

A name clearing hearing is not available every time an employee not entitled to the discipline process is terminated. A hearing is available only when any charges relating to the termination may stigmatize the employee's reputation, and the employee denies the truth of the charges. A charge is stigmatizing if it involves allegations of dishonesty, immorality or other conduct which may damage the employee's reputation and impair his ability to obtain other employment. Examples of stigmatizing charges may include: falsifying records; misappropriating property or funds; or charges the employee is untruthful, untrustworthy, unethical, or has committed a crime or other immoral act.

A request for a name clearing hearing must be filed by the employee in writing with the Deputy Director, Human Resources within fifteen (15) calendar days from the effective date of the termination of employment. The employee requesting the name clearing hearing must do so in writing. The employee must articulate what specific information contained in his personnel file would justify a hearing. The failure of an employee to request this hearing on a timely basis shall be considered as a waiver of the employee's rights under this policy.

Upon receipt of an employee's timely request for a name clearing hearing, the Deputy Director, Human Resources shall notify, via the chain of command, the Sheriff and the Office of General Counsel. The Deputy Director, Human Resources shall coordinate the arrangements for the hearing. The hearing shall be scheduled within fifteen (15) calendar days of the employee's request. The hearing shall be conducted by the Commander/ Director of Administrative Services. If the Commander/ Director of Administrative Services is unable to conduct the hearing because of personal involvement in the matter that led to termination, the hearing shall be conducted by a commander selected by the General Counsel.

The conduct of the hearing shall be informal. The sole purpose of the hearing is to provide an opportunity for the employee to present information for the record to clear his name. The employee shall be allowed to present testimony, witnesses and documents to support the employee's position the charges in question are untrue. The employee may have witnesses testify on his behalf and may have legal representation present. The employee may not compel the attendance of any witness, however an agency employee who agrees to testify for the employee shall be granted reasonable administrative leave in order to attend the hearing providing there is no disruption to Agency operations. In addition to accepting live testimony, the hearing officer(s) may also accept other documents which are relevant to the proceeding. A representative from the Office of Professional Responsibility designated by the Commander of OPR may provide a response to employee's presentation. The hearing officer(s) shall ensure a complete record of the hearing is made.

Within fifteen (15) calendar days after the hearing, the hearing officer(s) will issue a written report summarizing the information presented. A copy of the hearing officer's report and any other documentation provided by the employee shall be placed in the employee's personnel file. A copy of the report and any record of the hearing shall be provided to the terminated employee. The Deputy Director, Human Resources shall ensure a cover page is placed on top of the hearing information stating a name-clearing hearing was conducted.

If the hearing officer finds in the employee's favor, the contested information will be sealed. Sealed information will



Administrative and Operational Manual

September 12, 2022

not be disclosed outside the Agency except pursuant to operation of law or court order.

The role of the Office of General Counsel during a name-clearing hearing and process is to advise the Deputy Director of Human Resources and the hearing officer. Except when given during the hearing itself, the advice of the Office of General Counsel is confidential and subject to the attorney/client privilege.

### 3-750 EMPLOYEE GRIEVANCE PROCESS

The grievance process is designed to allow an organizational method of identifying problems and personnel dissatisfaction within the Agency and resolving differences between the employee(s) and the management structure of the Agency. The process shall not serve as an appeal process for sworn or corrections disciplinary action and shall not be applicable to any issue which is subject to the provisions of the Annotated Code of Maryland, the section commonly referred to as the Charles County Correctional Officers' Bill of Rights.

It is in the best interest of all segments of the organization to resolve differences expeditiously. Division commanders / directors, managers, and administrators should seriously consider each grievance brought to their attention with the purpose of arriving at an equitable settlement of the matter at their level of authority. If that is not possible because of the limits of their authority or an impasse in negotiations, the matter should be referred cordially to the next level of the grievance process.

The Deputy Director, Human Resources shall be responsible for the coordination and monitoring of the grievance process as well as maintaining all records resulting from filed grievances. The Deputy Director will provide an annual analysis report outlining grievances filed for that time period and disposition of each grievance filed. Copies of the annual report will be forwarded to the Office of General Counsel, the Chief of Staff, the Assistant Sheriffs and the Sheriff.

#### 3-750.1 DEFINITIONS

**Grievance** - is defined as a dispute, claimed violations, misinterpretation or misapplication of the rules or regulations governing the employee's terms and conditions of employment. "Grievance does not include those matters listed in 3-750.2.

**Working Days** - as used in this section shall mean the weekdays, Monday through Friday, and does not include Saturdays, Sundays or County holidays.

#### 3-750.2 EXCLUSIONS

The employee grievance procedure shall not be available in the following circumstances:

- terms and conditions of employment for part-time or probationary employees;
- terms and conditions of employment for appointed positions;
- terms and conditions of employment for contractual employees;
- position classifications;
- actions taken by the Sheriff which are policy decisions and are not management / administrative actions;
- non-selection for promotion when the sole reason for the grievance is based on personal opinion, and is not substantiated by fact;
- performance ratings, which are governed by separate appeal procedures; or
- oral counseling.



Administrative and Operational Manual

September 12, 2022

### 3-750.3 GRIEVANCE PROCEDURES

Employees are required to be familiar with the grievance process defined by this section and invoke the formal process when informal methods have failed to resolve conflicts. Employees should initially discuss problems and differences with their immediate supervisors. It is important to develop a dialog between supervisors and employees which deters misunderstandings and solves problems before they become significant.

#### 3-750.3.1 INFORMAL GRIEVANCE PROCEDURES

The grievable subject shall be discussed with the employee's supervisor and/or first-level manager within ten (10) work days of the occurrence. The supervisor or first-level manager shall attempt to resolve the issue and respond in writing to the employee within five (5) working days of the discussion. The response shall state the proposed resolution and inform the employee of the employee's right to pursue this matter through the formal grievance procedure. A copy of this letter shall be sent to the Deputy Director, Human Resources. If the supervisor or first-level manager does not respond within 5 working days, the employee may proceed to Level One as described in 3-750.3.2.

#### 3-750.3.2 FORMAL GRIEVANCE PROCEDURES

##### Level One

The formal grievance process will be initiated through written memorandum to the division commander / director of the grieved employee and only after participation in the informal grievance procedures. The grievance must be filed within ten (10) working days of the conclusion of the informal grievance process (Section 3-750.3.1).

The written grievance shall contain all of the points of contention for which the employee desires resolution in the particular instance. A written grievance must contain the following information:

- A statement of the facts upon which it is based;
- The identification of a specific wrongful act(s) committed and harm done;
- A statement of the remedy or adjustment sought.

No consideration shall be given to any issue not raised in this original written grievance to the division commander / director. This rule is necessary in order that some resolution may be reached. As a practical necessity, if the nature of the original grievance was allowed to change, develop and/or reform during the process, no matter would ever likely be resolved.

The division commander / director will review the written grievance to determine if it meets all eligibility requirements as depicted in this policy. When the grievance meets eligibility criteria, the division commander / director shall meet with the grievant, investigate the grievance and provide a written decision to the grievant no later than five (5) working days after receiving the grievance. A copy of the complete file shall be sent to the Deputy Director, Human Resources immediately following conclusion of this step.

If the division commander/director does not provide a written decision within 5 working days, the employee can proceed to Level Two.

##### Level Two

If the grievance has not been resolved at the division level, the employee must contact the Deputy Director, Human Resources in writing within five (5) working days of the response provided by the division commander / director requesting that the grievance be heard by the Grievance Review Board.



**Administrative and Operational Manual**

**September 12, 2022**

For non-disciplinary appeals, it is not necessary for the employee to repeat the facts of the grievance. Only those points in the original written grievance to the division commander / director will be addressed by the Board.

For disciplinary appeals, the employee's written notice to the Deputy Director, Human Resources must explain the employee's dispute with the proposed disciplinary action. The employee may dispute the factual basis for the imposition of discipline or the nature of the proposed discipline.

Rejection - The Deputy Director, Human Resources will determine whether to accept, remand or reject, in whole or in part, any grievance presented. A grievance may be rejected if the aggrieved employee has not completed action under the informal grievance procedure, if the grievance is not presented within the five (5) day time limit, or if it does not provide a clear statement of the issue and does not indicate the specific corrective action desired. The Deputy Director may remand the grievance to the grievant for clarification or additional information.

### **3-750.3.3 GRIEVANCE REVIEW BOARD**

The Deputy Director, Human Resources will coordinate the operation of the Grievance Review Board. The Grievance Review Board shall convene for a hearing within ten (10) working days of the acceptance of the grievance by the Deputy Director.

The Grievance Review Board will consist of:

- a Captain or director from a division other than the aggrieved employee's division (this person will act as chairman);
- a Lieutenant or civilian manager or supervisor from the same Agency segment as the aggrieved employee; and
- a non-management employee from a division other than the aggrieved employee's division.

The following persons shall have access to all Grievance Review Board proceedings:

- the Deputy Director, Human Resources or designee, who will be responsible for process evaluation and who will be the custodian of the Board's records; and
- the Office of General Counsel, which will advise the Board and/or the Deputy Director of Human Resources. Except when given during the hearing itself, the advice of the Office of General Counsel is confidential and subject to the attorney/client privilege.

#### **Hearing Board Proceedings**

Prior to the hearing, the Deputy Director, Human Resources will provide each Board member with a copy of the employee's grievance and a copy of any investigation related to the grievance. Members of the Board may not conduct their own investigation into the grievance.

The Deputy Director, Human Resources will establish the procedures for the hearing to include the setting of time limitations. The Deputy Director may at any time during the proceedings, limit or extend the scheduled time constraints if the hearing is not progressing according to schedule.

The Board will request the grievant to restate his grievance, to present additional information relevant to the grievance and to call any witnesses who can be expected to contribute materially to the issue. The grievant may not compel the attendance of any witness. An agency employee who agrees to testify for the employee shall be granted reasonable administrative leave in order to attend the hearing, providing there is no disruption to Agency operations. The grievant may not call as witnesses members of the Board, the involved division commander / director, the Deputy Director, Human Resources, or Office of General Counsel.



**Administrative and Operational Manual**

**September 12, 2022**

The Board will request the division commander / director of the employee, to represent management in these proceedings and to present all facts and evidence available to them which bear on the grievance. The Board will have the opportunity to ask questions and clarify information throughout the hearing. At the conclusion of the hearing, the employee will have the opportunity to present closing remarks and the division commander / director will have the opportunity to present closing remarks. The Board will then adjourn to consider the case.

The determination of the Board shall be by majority vote. At the conclusion of their deliberations, and within five (5) working days of the hearing, the Board will provide a written report of its findings and recommendations for actions by management to the Deputy Director of Human Resources. The Grievance Review Board has wide discretion in determining a resolution. The Grievance Review Board may increase or decrease any previously recommended action.

The Deputy Director, Human Resources will serve a copy of the Board's written report on the grievant and the management representative. The Deputy Director, Human Resources will further advise the grievant of his right to appeal the findings of the Board to an Assistant Sheriff if the grievant so desires.

The Deputy Director, Human Resources will make a record of the proceedings and the findings of the Board. This record, with all attendant documents, will be preserved for not less than three (3) years in the Human Resources records.

The hearing will be closed to anyone other than those participants noted.

**Level Three**

In all cases, the Deputy Director, Human Resources shall, upon receipt of the Grievance Review Board findings, forward them to the Commander / Director, Administrative Services. The Commander / Director shall meet with the Assistant Sheriff of Administration to present the facts of the grievance and the recommended resolution. This meeting will take place as soon after receipt of the Board's findings as possible. Within ten (10) working days of receipt of the Grievance Review Board's findings and in the absence of any appeal, the Board's findings will be acted upon if no appeal has been filed.

**3-750.3.4 APPEAL PROCEDURES**

In the event the action of the Grievance Review Board does not satisfy the employee, he may, within five (5) working days of receiving the Board's findings in writing, appeal the findings of the Grievance Review Board to an Assistant Sheriff. Such appeal will be made in writing to the Assistant Sheriff who is not in the employee's chain of command. The Assistant Sheriff will review the record of the case and, at the Assistant Sheriff's discretion, meet with the employee. The Assistant Sheriff will notify the employee in writing, within ten (10) working days, of his findings and decision which will be final.

**3-750.4 GRIEVANCE PROCESS TIME LIMITS**

Time limits may be extended by the Deputy Director Human Resources, upon written request and for good cause. If the grievant fails to pursue any steps within the time limits, he shall have no further right to continue the grievance.

**3-750.5 REPRESENTATION**

A grievant may request a Sheriff's Office employee, or other advocate of the employee's choice (at the employee's expense if other than an employee of the Sheriff's Office), be present and represent the grievant at any step of the procedure. Any Sheriff's Office employee who assists another employee in this manner shall be granted reasonable administrative leave to participate in the grievance process during working hours, providing there is no disruption



Administrative and Operational Manual

September 12, 2022

to Agency operations. Stenographic assistance may be involved at any step of the procedure at the expense of the grievant, if involved on behalf of the grievant, or at the expense of the CCSO, if on its behalf.

### 3-750.6 ADMINISTRATION

Written grievances, appeals, decisions and all associated records or correspondence shall be forwarded to the Deputy Director, Human Resources for review and filing. These records are sensitive and shall be maintained in a secured file. Access to the files shall be limited to the Deputy Director and Commander / Director, Administrative Services, or the Office of General Counsel.

Any Agency employee involved in the grievance process shall not be subjected to reprisal, discrimination or jeopardy as a result of having invoked the grievance process or for his involvement in the grievance process.

### 3-800 USE OF FORCE POLICY

Decisions regarding the use of force, weapons, and lethal force must be made quickly. Therefore, the contents of the Manual regarding the use of force shall be committed to memory by all sworn and correctional officers. The employee is not required to recite the sections verbatim, but must be able to apply the information to situations encountered without physical reference to the Manual.

Employees may not use force against a person unless, under the totality of the circumstances, the force is necessary and proportional to prevent an imminent threat of physical injury to a person or to effectuate a legitimate law enforcement objective. The use of excessive force, regardless of the provocation or action of the recipient, shall result in disciplinary action, up to and including termination, and may result in criminal prosecution and civil action.

The Agency does not intend this policy to be so restrictive as to impose greater dangers to employees and innocent citizens than would exist without the policy.

#### 3-800.1 DEFINITIONS

**Active Aggression:** the display of an immediate and serious physical threat to cause injury to an officer or another person. Active aggression may include, but is not limited to, a subject taking a fighting stance, punching, kicking, striking, attacks with weapons, or other actions which an officer reasonably believes present an imminent threat of physical harm to the officer or another. Flight or non-violent resistance does not, in and of itself, equate to active aggression.

**Agency Issued Rifles:** rifles issued for on-duty use by the Agency. Current issue rifles will be based on the AR-15 platform. The rifle will be chambered for 5.56 / .223, and capable of semi-automatic fire only.

**Alternate Duty Firearm** - a firearm approved to be carried in lieu of the duty firearm under specific circumstances for a specific employee.

**Alternate Duty Flashlight** – a personally owned flashlight approved by the Agency.-

**Armorer:** Agency personnel specially trained to inspect and conduct maintenance of an authorized, specified Agency weapon system.

**ASR** - Aerosol Subject Restraint. A pressurized chemical spray used to control or temporarily disable a person without long term effect.



Administrative and Operational Manual

September 12, 2022

**Authorized Weapons** - weapons which are approved by the Agency and which the officer has been trained and qualified to use.

**Chief Firearms Instructor** - the employee who is a certified firearms instructor responsible for all Agency firearms training, qualifications, records, and a certified range officer responsible for the safe operation and maintenance of the firearms range.

**Collapsible Baton** - a metal expandable baton designed to occupy minimum space on the duty belt.

**Conducted Energy Weapon (CEW):** a device that emits a non-lethal electronic energy charge which causes neuromuscular incapacitation (NMI).

**Data-port:** a built-in data-port of a CEW which allows internally recorded data from each firing of the device to be downloaded to a computer.

**Deployment:** The active use of an instrument.

**K-9 Deployment:** the use of a K-9 team for the purpose of criminal apprehension and/or to gain compliance.

**Display:** The sparking of a CEW or the showing of an instrument for the purpose of gaining compliance.

**Drive Stun Mode:** The application of a CEW directly onto the body as a pain compliance technique or to complete the circuit to achieve neuromuscular incapacitation (NMI) with a lodged probe.

**Duty Firearm** – an Agency-owned and issued firearm which is carried in the daily performance of the employee's specific duties.

**Firearms Range** - any facility designed for the discharging of firearms under the direct control of the Sheriff's Office by way of ownership or agreement.

**Firearms Specialist:** the Firearms Tracking Specialist assigned to the Property Management Division.

**FN-303 Projectile Launcher:** an instrument designed to launch a fin-stabilized projectile by the means of compressed air to a maximum effective range of 55 yards.

**Imminent Threat of Physical Injury:** The physical or verbal act by an individual which an officer reasonably believes indicates intent and a present ability to inflict immediate injury or poses a serious safety threat to the officer or another person. Consideration must be given to the totality of the circumstances known to the officer at the time.

**Injury** – damage to the body caused by external force, or a complaint of injury, whether visible or not.

**Instrument:** a weapon which is approved by the agency to be utilized by an officer when they need to use physical force in situations which cannot be otherwise controlled. These instruments include, but are not limited to: Impact weapon, ASR, CEW, FN-303 or any other weapon which the agency utilizes.

**Lethal Force** - force which is likely to cause death or serious physical injury.

**NMI:** Neuro Muscular Incapacitation.

**Non-Lethal Force** - force which is neither likely nor intended to cause death or serious physical injury.

**Non-Violent Resistance:** refusal by an unarmed person to comply with an officer's verbal commands or physical





## Administrative and Operational Manual

September 12, 2022

control techniques resulting in non-violent resistance to a lawful seizure. The subject is not complying with an officer's commands and is uncooperative, but is taking non-violent action to prevent an officer from placing the subject in custody and taking control. Examples include, but are not limited to, standing stationary and not moving upon lawful direction, falling limply and refusing to use their own power to move (becoming "dead weight"), holding onto a fixed object, locking arms to another during a protest or demonstration.

**Off-Duty Firearm** - a firearm that is specifically approved for off-duty use by the Chief Firearms Instructor. The employee must qualify annually to receive approval.

**Primary Duty Flashlight** – an Agency issued flashlight to be worn on the duty belt.

**Probe Mode:** CEW setting in which two (2) probes are fired from a disposable cartridge which releases electrical pulses into the body.

**Reasonable Belief** - What a reasonable and prudent officer would believe based on the totality of the circumstances known to the officer.

**Serious Physical Injury** - Physical injury which creates a substantial risk of death; causes serious permanent or serious protracted disfigurement; or results in long-term loss or impairment of the functioning of any bodily member or organ (Criminal Law, § 3-201(c)).

**Stun-Cuffs:** a device designed for the temporary non-lethal incapacitation of a violent or resisting individual, with a minimal likelihood of serious injury.

**Weapon mounted light** – an Agency approved light mounted to any Agency-owned and issued weapon.

### 3-800.2 AUTHORIZATION TO USE FORCE AND REQUIRED TRAINING

Employees who use force shall use only that amount of force which is necessary to accomplish a lawful purpose.

All sworn and correctional officers will complete a recruit training program to include comprehensive training on all Agency use of force policies and all other related instruction prior to their assignment in any capacity which allows the carrying of lethal and/or non-lethal weapons / instruments or places the officer in a situation to affect an arrest. Officers can receive additional training that expands the types of use of force available to them in a particular circumstance. Completion of the initial training, as well as required refresher training, as defined in each individual weapon policy, will be documented by the Training Division.

### 3-800.3 MEDICAL AID

When an employee uses force and a person is injured or complains of injury, the employee shall provide medical aid as quickly as practical. Medical aid may include:

- increased observation to detect obvious changes in condition;
- flushing chemical agents from the eyes;
- rendering first aid;
- applying Tactical Emergency Casualty Care (TECC) trained methods;
- contacting Communications for activation of Emergency Medical Services (EMS) personnel; or
- for more serious or life-threatening incidents, providing for treatment by medical professionals.

Documentation of all injuries and the medical aid obtained or offered for the person injured shall be made on the appropriate reports associated with the instant case.



Administrative and Operational Manual

September 12, 2022

### 3-800.4 LETHAL FORCE

The use of lethal force is justified when lesser force is insufficient to accomplish a lawful purpose and such use is not specifically prohibited by law or Agency policy. Specifically, lethal force may be used:

- to protect oneself from death or serious physical injury; and/or
- to protect another from death or serious physical injury; and/or
- to apprehend a fleeing person when no reasonable alternative for apprehension exists and the officer has probable cause to believe that the person fleeing:
  - has committed or attempted to commit a life-threatening felony causing the death of another person or involving the infliction or threatened infliction of serious physical injury to another person, **and**
  - poses an immediate and significant threat of death or serious physical injury to the officer or to others if he is not immediately apprehended.

The Agency will provide training for all sworn personnel on the Agency's use-of-lethal-force policies during annual in-service training.

### 3-800.5 PROHIBITED USE OF FORCE

Choke, strangle, or similar control techniques intended to reduce blood or oxygen to the brain for the purpose of gaining control of a subject are prohibited unless the use of deadly force is justified under this policy.

Targeted head strikes with any weapon are prohibited, unless the use of deadly force is justified under this policy. Warning shots of any type are prohibited. Additionally, firearms should not be used as an impact weapon, unless deadly force is authorized.

Employees of the CCSO are issued a collapsible baton as the Agency impact weapon. Therefore, blackjacks / slapjacks are obsolete weapons for all employees. No employee shall carry or use these obsolete weapons in the performance of their duties.

PR-24 Batons are also not permitted to be used.

### 3-810 USE OF FIREARMS

An employee shall not draw or display a firearm except for official use as provided for in this policy. An employee should not draw a firearm unless the employee reasonably anticipates a need to use it. When necessary, the firearm shall be aimed center of mass, as taught in Agency firearms training. The employee will cease firing when the threat no longer exists.

#### 3-810.1 AUTHORIZED USE OF FIREARMS

An employee who is authorized, trained and certified to carry firearms may discharge a firearm in connection with the performance of official duties, for the following reasons:

- for target practice or other activities at a range; or
- to kill an injured or dangerous animal when other alternatives are impractical or unavailable; or
- when deadly force is justified under Agency policy.

Recruit police and correctional officers who are in initial training at the Academy and employees who are being trained on various weapons platforms (such as shotguns, rifles, snipers, etc.) are not certified until successful completion of the requisite course. However, they are authorized to use the weapon while participating in training



Administrative and Operational Manual

September 12, 2022

exercises and at the range during the course of the training.

### **3-810.2 SHOOTING AT OR FROM A MOVING VEHICLE**

Discharging a firearm at or from a moving vehicle is rarely effective and can create substantial risks to other motorists, bystanders and other uninvolved parties within the target vehicle. Out of control vehicles and rounds that do not impact their intended target are the primary risks when shooting at or from a moving vehicle. These risks should be considered, along with all other factors, when making the decision to fire the weapon.

Officers are therefore generally discouraged from firing any weapon at or from a moving vehicle except when the justification exists to utilize lethal force, including the following circumstances:

- it reasonably appears the moving vehicle would endanger officers or the public,
- it is reasonably perceived the vehicle is being used as a weapon against the officer or others and other reasonable means of defense have been exhausted or are not present or practical, or
- to stop a fleeing suspect when the officer has probable cause to believe the suspect has committed, or intends to commit, a felony involving the infliction or threatened infliction of serious bodily injury or death and the officer believes there is an imminent or potential risk of serious bodily injury or death to others if the suspect is not immediately apprehended.

When feasible, a loud verbal warning should be given prior to discharging the firearm. Officers should avoid positioning themselves in the path of a moving vehicle.

### **3-810.3 CARRYING OF FIREARMS BY PERSONS AUTHORIZED BY LAW**

No person, other than sworn law enforcement officers or correctional officers as part of their assigned duties, will be allowed to carry a firearm on property or in buildings owned or controlled by the Sheriff without prior authorization from the Sheriff or his designee.

Non-sworn CCSO employees who desire to carry a firearm on property or in buildings controlled by the Sheriff must submit a Request to Carry Firearm, Form #935, to the appropriate Assistant Sheriff or his designee for authorization. Employees making such a request will attach a copy of a valid Maryland Gun Permit or their most recent LEOSA certification, along with their retired police agency ID card. Authorization will be granted on a case-by-case basis.

Once they have been approved, employees shall submit a request for authorization annually, by December 31 for the following calendar year. Along with the request for authorization, employees must submit the following:

- Copies of their valid Maryland Gun Permit and certification from the CCSO Training Division that they satisfactorily completed annual firearms training; or
- A copy of their most recent LEOSA certification.

## **3-820 SHERIFF'S AUTHORIZATION TO CARRY FIREARMS**

This section defines when the Sheriff authorizes the carrying of a firearm. Any employee who possesses a firearm outside of the Sheriff's authorization must comply with State and federal law such as a carry permit or the Law Enforcement Officer Safety Act (LEOSA).

### **3-820.1 DEFINITIONS**



Administrative and Operational Manual

September 12, 2022

**Alternate Duty Firearm** – a firearm approved to be carried in lieu of the duty firearm under specific circumstances for a specific employee.

**Authorized Weapons** – weapons which are approved by the Agency and which the officer has been trained and qualified to use.

**Duty Firearm** – an Agency-owned and issued firearm which is carried in the daily performance of the employee's specific duties.

**Off-Duty Firearm** – a personally owned firearm that is specifically approved for off-duty use by the Chief Firearms Instructor. The employee must qualify annually to receive approval.

**Personally Owned Firearm** – are firearms an employee owns that may require the Sheriff's authorization or Agency qualification to carry. Possession, carrying, and/or use of a personally owned firearm is controlled by federal and State law and the Sheriff's authorization if carried while operating an Agency vehicle.

### 3-820.2 SWORN POLICE/ CORRECTIONAL OFFICERS' RESPONSIBILITIES

Sworn police officers of the Agency are considered to be always available to perform their duties. Therefore, while on-duty or while operating an Agency vehicle (whether on-duty or off-duty), sworn police officers shall be armed with a duty, alternate duty or off-duty firearm, except in the circumstances identified below. While on-duty and wearing a uniform or authorized alternative apparel that readily identifies the sworn employee as a Police Officer, there is no requirement to conceal the employee's firearm. While off-duty in Charles County, sworn police officers are authorized, but not required to, be armed. Sworn police officers will wear their badge next to their holster or in an easily accessed area on their person, to be readily displayed, when carrying their firearm concealed.

In accordance with the Law Enforcement Officers Safety Act (LEOSA), 18 U.S.C. §926, sworn police officers who live or travel outside of Charles County or the state of Maryland are afforded the privilege to be armed but must comply with the laws of the state where they live or travel. Sworn police officers may carry their duty firearm outside of the State and must comply with LEOSA requirements.

Sworn police officers are not required to be armed if:

- An officer's supervisor/ commander determines that the carrying of a weapon or Agency identification could jeopardize a covert operation or investigation. In these cases, commanders may make specific exceptions, or general exceptions, for certain situations or circumstances. These exceptions will be conveyed in writing within the unit SOP Manual, or will be given in writing to an individual member of the commander's component. Individual members who, because of covert circumstances which arise unexpectedly, decide to exercise the exception of this section must be prepared to provide sufficient justification for their actions.

All employees are prohibited from carrying an Agency-owned firearm under these circumstances:

- Attending any court as a defendant in a criminal trial, a plaintiff or defendant in a civil trial, or while serving as a juror, or in any other circumstance where the court prohibits the carrying of a firearm. (In any case, employees must comply with the specific provisions of this Manual regarding firearms within the Charles County Courthouse).
- While drinking or consuming alcohol.
- While under the influence or impaired by alcohol, drugs, controlled dangerous substances, or any combination.
- Whenever carrying a firearm is specifically prohibited by law.



**Administrative and Operational Manual**

**September 12, 2022**

The Sheriff's authorization to carry alternate duty or off-duty firearms, does not extend to these circumstances:

- Attending any court as a defendant in a criminal trial, a plaintiff or defendant in a civil trial, or while serving as a juror, or in any other circumstance where the court prohibits the carrying of a firearm. (In any case, employees must comply with the specific provisions of this Manual regarding firearms within the Charles County Courthouse).
- While drinking or consuming alcohol.
- While under the influence or impaired by alcohol, drugs, controlled dangerous substances, or any combination.
- Whenever carrying a firearm is specifically prohibited by law.

Firearms shall not be removed from concealment or from their holster unless there is intent to use them for a lawful purpose. Firearms may additionally be un-holstered:

- when they are to be unloaded in a safe location; and/or
- when they are presented unloaded for inspection by a superior; and /or
- when they are placed in secure storage; and/ or
- when they are presented unloaded for approved maintenance; and/ or
- when they are to be fired on the firing line of an approved range; and/ or
- when it is necessary because of an operational threat to be ready to use the firearm, even though the use is not eminent.

In the performance of their official duties, some correctional officers are authorized and required to be armed. These correctional officers may carry and use firearms only during duty hours. During these times, they will adhere to all policies contained in this Manual regarding the use of firearms.

### **3-820.3 FIREARMS RANGE USE**

In order to limit our Agency's exposure to liability, no employee, employee's family member or citizen shall enter an Agency operated firearms range facility without authorization. To seek authorization, an employee must prepare a memorandum to the Chief Firearms Instructor. The Chief Firearms Instructor will ensure a Range Safety Officer will be present during such events. The Range Safety Officer will provide for the overall safety of all personnel on the range. Prior approval does not apply to authorized Correctional Officers, the Firearms Tracking Specialist, the Forensic Science Section or for any previously approved programs such as "Retiree Certifications."

#### **3-820.3.1 RANGE SAFETY**

Firearms range safety can never be over-emphasized. It is the duty of all those utilizing the range, and the responsibility of the Sheriff's Office, to ensure the safety of all individuals at the range. The following criteria will be adhered to by all individuals utilizing the range whether they are shooters, line instructors, or spectators:

- all shooters will wear appropriate eye and ear protection at all times;
- there will be no handling of loaded firearms behind the firing line;
- all long guns shall be placed in the designated weapons rack unless the shooter is on the firing line;
- the Chief Firearms Instructor shall make a trauma kit readily available during all live fire exercises;
- weapons will be 'charged' or loaded only on the firing line;
- no alcoholic beverages are permitted in the range area;
- no person may be present in the range area while under the influence of alcohol and/ or drugs;
- during various training scenarios, all weapons will be pointed downrange unless approval from an instructor has been given; and
- all instructors and shooters will ensure that all rounds fired will be directed into the impact area located



Administrative and Operational Manual

September 12, 2022

directly behind the turning target system.

Any firearm carried at the range and not on the firing line shall be carried in one of the following manners:

- securely holstered;
- in a weapons carrier or case; or
- unloaded with the action, bolt, slide or cylinder open, depending on the specific firearm.

Only weapons, ammunition, targets and equipment authorized by the Commander, Training Division or the Chief Firearms Instructor shall be permitted for use during qualification and training events at the range. All firearms, ammunition and holsters at the firearms range are subject to a safety inspection by any firearms instructor or range officer at any time. Defective or unsafe firearms, ammunition or holsters shall not be used until repaired or replaced. During qualification or firearms training, range safety protocol will be reviewed and firing will be done only on command from the on-duty range officer. The course of fire and safety regulations will be approved by the Chief Firearms Instructor.

### 3-820.4 AUTHORIZED FIREARMS

No employee shall use a firearm in his official capacity with the Agency unless that firearm is issued to him or approved for use by him as in his official capacity or as an off-duty firearm.

#### 3-820.4.1 DUTY FIREARMS

The current issued handgun for all sworn officers and the Corrections Division of the CCSO, is the Smith & Wesson M&P .40-caliber semi-automatic pistol. Duty firearms shall be carried in a fully loaded and ready to use condition as instructed during qualification and certification training. The duty firearm shall be carried in the issued holster, or one approved by the Chief Firearms Instructor.

A second handgun will not be worn by personnel while on duty.

#### 3-820.4.2 USE OF ALTERNATE FIREARMS WHILE ON DUTY

Officers may request to carry an alternate firearm in lieu of their agency-issued handgun. The firearm must be, either 9mm or .40 caliber S & W, purchased by the employee and must meet the other specifications in this policy. The employee must qualify with the alternate handgun in accordance with Section 3-820.4. The request will be made through an Alternate Duty Weapon Request Form #906 and shall:

- contain a specifically stated purpose;
- be for a specifically stated time period and/or while working a specific assignment;
- cover only the specifically named individual employee;
- describe the firearm(s) and associated serial number(s) attributed to a particular employee;
- contain qualification scores for day and night fire;
- contain a statement that the commander has examined the qualification records for the employee and found the employee properly qualified with the firearm.

Any alternate duty handgun carried by an employee shall require an inspection by the Chief Firearms Instructor, endorsement by the Division Commander and written authorization by the appropriate Assistant Sheriff. The recommendation will be based upon some specific assignment, for example, a temporary undercover vice assignment. The Sheriff, Assistant Sheriff or the sworn officer's division commander may revoke this approval as they may deem appropriate. The original written approval shall be given to the employee. The division commander shall keep a copy for the period during which the approval is valid. A copy shall be forwarded to the Chief Firearms



Administrative and Operational Manual

September 12, 2022

Instructor, the Assistant Sheriff and the employee's personnel file.

A weapon mounted light is not required for an approved alternate duty weapon. The officer may elect to install their agency issued weapon mounted light, or purchase at their own expense, a smaller weapon mounted light from a reputable manufacturer.

**3-820.5 SPECIFICATIONS FOR OFF-DUTY FIREARMS**

This subsection applies to "off-duty firearms." Off-duty firearms are personally owned firearms that are specifically approved for off-duty use by the Chief Firearms Instructor. The employee must qualify annually.

Employees who carry a firearm off-duty will carry that firearm in accordance with state law and to policies within the AOM regarding firearms control. Off-duty firearms will be carried loaded and ready to use as instructed during a certification and qualification course. All Agency and off-duty handguns will be carried in a holster approved by the Chief Firearms Instructor; the holster shall have retention and cover the trigger of the firearm. Any firearm that does not meet the definition of Agency off-duty or alternate firearm will be considered a personal firearm.

All off-duty, semi-automatic pistols shall conform to the following specifications:

- caliber of ammunition shall be .357 auto, 9mm, .40 caliber Smith and Wesson, .45 caliber ACP or .380 auto; and
- the action of the handgun shall be either the Glock Safe Action, double action only, or striker fired action; and
- a single ammunition magazine must be capable of containing 6 rounds or more; and
- the slide shall lock open automatically upon firing the last round in the handgun.

All off-duty revolvers shall conform to the following specifications:

- shall be either .38 or .357 caliber; and
- shall be capable of double action firing; and
- have a barrel length of 2 inches to 4 inches; and
- shall have a cylinder capacity of at least five rounds.

Only those employees who have received entry level training and qualification in the use of revolvers shall be allowed to carry these off-duty weapons. Approval shall be contingent upon the continuous ability to annually qualify with the revolver.

If the firearm uses ammunition not stocked by the Agency, the employee is required to furnish, at his own expense, the ammunition required to practice and qualify with the firearm. Ammunition will be of a type and caliber approved by the Assistant Sheriff and the Chief Firearms Instructor.

**3-820.5.1 MODIFICATIONS TO FIREARMS**

Firearms approved for duty use shall not be modified or have accessories added. Accessories which are not authorized may include but are not limited to: add-on handgrips, grip tape, battery assist levers, electronic sights and scopes. The Emergency Services Team is exempt from the guidelines laid forth in this section. There are no other exceptions to this policy.





Administrative and Operational Manual

September 12, 2022

[REDACTED]

**3-820.6 PERSONALLY OWNED FIREARMS**

“Personally owned firearms” are firearms an employee owns that may require the Sheriff’s authorization or Agency qualification to carry.

- An officer who wishes to carry a personally owned firearm off-duty and while operating an Agency vehicle, must be specifically approved to carry that firearm by the Chief Firearms Instructor. The employee must qualify annually to receive approval, and must follow the policies outlined in 3-820.5.
- An officer who chooses to carry a personally owned firearm, without the Sheriff’s authorization and Agency qualification, may not carry that firearm while operating an Agency vehicle and must comply with State and federal law, such as a carry permit or the Law Enforcement Officer Safety Act (LEOSA) 18 U.S.C. § 926.

LEOSA allows a “qualified law enforcement officer” to carry a concealed firearm in any jurisdiction in the United States. A “qualified law enforcement officer” is any individual employed by a governmental agency who:

1. is authorized by law to engage in or supervise the prevention, detection, investigation, or prosecution of, or the incarceration of any person for any violation of law, and has statutory powers of arrest, or apprehension under section 807(b) of title 10, United States Code (article 7(b) of the Uniform Code of Military Justice), including state and public college/university police officers;
2. is authorized to carry a firearm;
3. is not the subject of any disciplinary action by the agency which could result in suspension or loss of police powers;
4. meets standards, if any, established by the agency which require the employee to regularly qualify in the use of a firearm;
5. is not under the influence of alcohol or another intoxicating or hallucinatory drug or substance; and





Administrative and Operational Manual

September 12, 2022

6. is not prohibited by Federal law from receiving a firearm.

A law enforcement officer carrying a firearm under LEOSA must carry photographic identification issued by the Agency that identifies the officer as a law enforcement officer with the Agency.

Employees carrying a firearm under the authority of LEOSA are responsible for knowing and complying with LEOSA requirements and restrictions.

Some states require an individual to obtain a carry permit or license to lawfully carry a handgun. Employees who choose to carry a firearm outside of the Sheriff's authorization are responsible for knowing and complying with state laws.

### 3-820.7 AUTHORIZED AMMUNITION

Only ammunition which is issued or approved by the Agency shall be used in weapons carried and used while an employee is in a duty status. For the purposes of this section only, duty status includes those times when an employee is using an assigned vehicle or working part-time in a capacity allowed by his position with the Agency.

When off-duty, the employee may use any factory ammunition with similar characteristics as Agency issued duty ammunition designed for use in the particular weapon the employee has qualified with and is currently carrying. However, the following ammunition is restricted from use:

- any ammunition designed as armor piercing (steel or tungsten core bullet with full metal jacket);and
- any ammunition with explosive incendiary (percussion) heads, designed to explode on impact; and
- any ammunition with fluid filled cavities in the head designed to fragment on impact.

Hand loaded ammunition is prohibited for use in Agency firearms and will not be used by an employee either on- or off-duty, or during Agency sponsored practice or qualifications.

This section is not intended to limit any ammunition approved for use by the Emergency Services Team by the Commander, Special Operations and Chief Firearms Instructor. Members who are unsure of the approval of any ammunition for use may request written approval from the Chief Firearms Instructor.

### 3-820.8 FIREARMS QUALIFICATION

All officers are required to meet the minimum qualification requirements of the Maryland Police Training and Standards Commission. Qualifications will be coordinated by the Chief Firearms Instructor. All proficiency training will be monitored by certified firearms instructors. Officers are limited to qualifying with their duty handgun, shotgun, and one alternate firearm at a time. Officers may qualify with a maximum of two off-duty firearms during off-duty range dates. Officers who fail to qualify shall not be entitled to overtime or compensatory time for completing required qualifications.

Sworn officers who fail to qualify with their duty handgun are subject to the loss of police certification as mandated by the Maryland Police Training and Standards Commission. Loss of police certification can result in termination of employment.

After two attempts, if the officer fails to meet the minimum score in qualifying as established by the Maryland Police Training and Standards Commission, and have no apparent physical handicap, the following procedures shall be followed:

- the Chief Firearms Instructor shall immediately notify the Commander, Training Division or if unavailable, the officer's commander;



**Administrative and Operational Manual**

**September 12, 2022**

- the notified commander will require the officer to surrender his firearm and the officer will be placed in a non-sworn status;
- if the Commander, Training Division is notified, he will in turn notify the involved officer's commander of the actions taken;
- the Chief Firearms Instructor will coordinate the rescheduling of a range date and remedial training as needed;

If the involved officer continues to be unable to meet qualification requirements after remedial training, appropriate administrative action, to include suspension of police powers and/ or termination, shall be initiated by the officer's commander.

An employee who has been injured or who has recovered from an illness which may have had an effect upon the employee's ability to use a firearm, shall be required to re-qualify with the duty firearm before being allowed to return to duty. Failure to qualify shall be handled in the same manner as normal qualification.

The Chief Firearms Instructor will maintain qualification records by computer and will post the records on the Agency computer network. Supervisors or commanders may access employee qualification records on the network.

### **3-820.9 MARKSMANSHIP BADGES**

Pistol qualification badges shall be awarded based on daylight qualification with the Agency issued firearm. The following scores will be used to designate the authorized badge:

- Distinguished Pistol Expert      96% - 100%
- Pistol Expert                        90% - 94%
- Pistol Sharpshooter                84% - 88%
- Pistol Marksman                    78% - 82%

Officers who fail to score 78% will not be awarded a pistol qualification badge.

The determination of which badge will be worn will be made upon completion of the thirty-five hours basic recruit entry level class or the completion of re-qualification. In the case of entry level qualification, the final qualifying score shall be used to determine the appropriate badge. In the case of re-qualification, the first documented score shall be used. Officers shall wear the badge they have most currently qualified for.

When an employee qualifies for a badge different than the one currently issued to the employee, the employee shall respond within the first week of the following month to the Firearms Training Unit for a replacement badge. The Chief Firearms Instructor will exchange, at no cost to the employee, the former badge for the current qualification badge.

### **3-820.10 FIREARMS ISSUANCE**

All non-issued Agency firearms will be stored within the Agency Armory system under the control of the Commander, Property Management and the Chief Firearms Instructor or a designee. Prior to any firearm being issued for use, the Chief Firearms Instructor will inspect and approve it. Any firearm found to be unsafe for use will be tagged for repair or replacement.

Initial issuance of any firearm will be accomplished by the Chief Firearms Instructor only after the person being issued the firearm has completed all required recruit or other training programs and the Chief Firearms Instructor has certified the person has qualified with the firearm to be issued. The receiving person will sign a receipt for the firearm and the Armory log will be completed.



Administrative and Operational Manual

September 12, 2022

The Chief Firearms Instructor or his designee may assign firearms from the Armory on a temporary basis in exchange for a firearm in need of repair or when firearms are needed for training. This exchange/ temporary issue will be documented in the Armory log.

### 3-820.11 FIREARMS INSTRUCTORS

Employees of the Agency who are designated as Firearms Instructors, including the Chief Firearms Instructor, shall be certified by the Maryland Police Training and Standards Commission to give firearms instruction. Additionally, they shall each maintain, as a minimum, the Agency certification of "Pistol Expert" and qualify with a score of at least 90% on any other firearm system they instruct to Agency personnel. All instructors shall have emergency medical response training to supervise operations on the Agency range.

### 3-820.12 LOST, STOLEN OR SEIZED FIREARMS

If an officer's firearm is lost or stolen, the officer shall report the incident in accordance with policy found elsewhere in this Manual. A copy of the investigation will be forwarded to the Assistant Sheriff of Operations; Chief Firearms Instructor; Commander, OPR; and the Commander, Training. If an officer's issued firearm is collected as evidence, lost, or stolen, a replacement firearm will be issued by the Commander, Property Management or the Chief Firearms Instructor. The Loss/ Damage Report Form #310 will be the controlling document for firearm replacement.

**NOTE:** This section does not require a firearm to be issued to an employee who has been suspended or otherwise relieved of his authority to carry a firearm.

### 3-820.13 FIREARMS INSPECTIONS

On-duty firearms shall be inspected by the member's supervisor at the time of the monthly vehicle inspection and, additionally, at any other time the supervisor deems appropriate. The inspecting officer shall use the following procedures to ensure the safety of the officer, supervisor and the general public.

The officer being inspected shall (with the firearm pointed in a safe direction or into an unloading containment device if available):

- remove the magazine and secure it;
- retract the slide and empty the chamber;
- visually check the chamber and magazine well; and
- present the firearm to the inspector with the slide locked to the rear and in accordance with training.

The inspecting officer shall:

- examine the chamber and magazine well to ensure the firearm is unloaded;
- examine the firearm for dents, burns, rust, modifications, etc.;
- check the barrel for obstructions and powder fouling;
- check the slide for proper lubrication;
- remove the ammunition from the magazine(s) and ensure the magazine(s) and ammunition is of proper issue;
- check for the proper operation and condition of the magazine; and
- return the firearm, magazines and ammunition to the officer.

Handgun, shotgun and patrol rifle armorer's evaluation shall be conducted during the practice or qualification at the range by the Chief Firearms Instructor or his designee. The Chief Firearms Instructor or his designee shall verify the firearm is serviceable and in compliance with Agency policy. The serial number shall be verified and documented



**Administrative and Operational Manual**

**September 12, 2022**

by the Chief Firearms Instructor or his designee. Points of inspection shall be as follows after unloading:

- examination of exterior of the firearm for general overall appearance;
- interior of the barrel for obstruction(s), dirt, rust, etc.;
- approved ammunition and condition of the same, approved carry condition, "cruiser safe";
- the proper function of the safety, slide lock release, magazine follower, ejector, etc.; and
- when the inspection is performed in conjunction with the monthly vehicle inspection, the serial number of the firearm will be recorded on the Monthly Personnel & Vehicle Inspection Form #75. If the inspection is of personnel only, it will also be recorded on the Form #75.

Notifications of firearms issues shall be forwarded to the appropriate division commanders, Assistant Sheriffs, Sheriff and Chief Firearms Instructor at the discretion of the armorer.

### **3-820.14 HOME STORAGE OF FIREARMS**

Firearms in the home must be secured in a manner which prevents their casual access. Criminal Law, § 4-104 (c) of the Annotated Code of Maryland dictates that an unsupervised minor be denied access to a loaded firearm. Employees are required to prohibit access to Agency firearms by any unauthorized persons.

The Agency has provided trigger locks to secure the employee's issued handgun, if that handgun is to be taken home with the employee. Even with a firearm unloaded and the trigger lock applied, no employee shall leave an Agency firearm where it may be accessed by a minor or any unauthorized person.

### **3-820.15 UNLOADING CONTAINMENT DEVICES**

An unloading containment device shall be installed in each location where firearms inspections take place within the Agency and in any location where firearms are routinely unloaded for maintenance or cleaning. This device shall be designed and constructed to reduce the possibility of injury to personnel in the event of an accidental discharge occurring during the process of loading and unloading firearms. Wherever such a device is provided, firearms shall be loaded and unloaded utilizing this device.

### **3-820.16 SALE OF AGENCY HANDGUNS TO EMPLOYEES**

The Sheriff may consider the sale of a handgun to the employee who carried it. If the handgun carried is not available, one similar may be considered. The employee shall request the purchase in writing through the chain of command including the make, model, and serial number of the handgun. If the purchase is approved the Commander, Special Services will verify the handgun's availability and determine the associated costs.

The Commander, Special Services, or his designee shall initiate the lawful transfer through the Agency Firearms Specialist who will, ensure the submission of, all required documents to the Maryland State Police.

All Agency handguns will be turned in to the Chief Firearms Instructor and/or his designee to ensure the Employee Clearance Form #240 is properly completed and the firearm is removed from the Agency inventory. The Chief Firearms Instructor will be responsible for transporting the firearm to the Firearms Specialist for final processing and transfer to the employee.

For out-of-state firearms transfers, the employee shall submit to the Agency Firearms Specialist proper documentation for a federal firearms licensed dealer, from the state in which the employee will be residing and who will be processing the transfer of the firearm. Once all paperwork is submitted and any applicable waiting periods have expired the firearm will be shipped to the federal firearms dealer requested by the employee.



Administrative and Operational Manual

September 12, 2022

In all cases, the Agency Firearms Specialist will ensure transfers are conducted legally.

The Commander, Special Services or his designee shall deliver the handgun to the employee for in-state transfers or the federal firearms licensed dealer that is handling the out-of-state transfer upon completion of paperwork and required waiting period. The employee's copy of the MSP Form #77R will be considered their receipt for in-state transfers. A copy of the employee's check shall be considered the receipt for out-of-state transfers.

Once the transfer is complete, the Agency Firearms Specialist shall ensure copies of the documents are provided to the employee, the Commander/ Director, Administrative Services, for placement in the employee's personnel file, and the Commander, Office of Professional Responsibility, to document firearms transfer into the Internal Affairs tracking software program and the Commander of the Training Division for inventory purposes. The original documents will be kept with the Agency Firearms Specialist.

The Commander, Special Services, or his designee shall submit the funds collected for the handgun to the Deputy Director, Accounting. The Commander, Special Services, shall order a replacement handgun as necessary to replenish the Agency inventory.

### 3-820.17 ACCIDENTAL DISCHARGE OF FIREARMS

This policy applies to all cases of accidental discharge of an issued firearm or other firearm that a sworn/ correctional officer is qualified by the Agency to carry. This policy shall apply whether an injury occurs or not. Additionally this policy applies to all firearms accidentally discharged while on duty.

#### Involved Officer's Responsibilities

- When it occurs in Charles County:
  - The involved officer will immediately notify Communications
  - The involved officer will complete a use of force report in Blue Team
- When it occurs outside Charles County:
  - The involved officer will immediately notify Charles County Communications
  - The involved officer will complete a use of force report in Blue Team

#### Communications Responsibilities

- When it occurs in Charles County:
  - Communications will dispatch an on-duty supervisor or command officer to respond to the scene
  - Communications will ensure the on-duty shift Commander is immediately notified
- When it occurs outside Charles County:
  - Communications will immediately notify the on-duty shift commander

#### Shift Commander's Responsibilities

- When it occurs in Charles County:
  - The Commander will ensure a supervisor is dispatched to the scene
  - The Commander will immediately notify the employee's division commander/ Director
- When it occurs outside Charles County:
  - The Commander will determine, based on the circumstances and location of the incident, if the response of an agency supervisor or commander is necessary and/or feasible
  - The Commander will immediately notify the employee's division commander/ Director
  - The Commander will immediately notify the appropriate law enforcement jurisdiction



**Administrative and Operational Manual**

**September 12, 2022**

**Division Commander/ Director's Responsibilities**

- The Division Commander/Director will immediately notify the appropriate Major/Assistant Sheriff, the Commander of O.P.R. and the Commander of the Training Division

If the involved employee is unable to complete the report due to injury or other extenuating circumstance, it shall be completed by a supervisor or commander who either responded to the scene or who obtained information about the discharge occurring outside the County. The Commander, O.P.R. shall ensure a copy is forwarded to the Chief Firearms Instructor.

The involved employee's commander shall review the circumstances of each instance of an accidental discharge. The commander shall coordinate with the Training Division to ensure the employee receives remedial training. The Chief Firearms Instructor shall review the circumstances of each incident on a case by case basis to determine what level of remedial training is required. Upon completion, a Remedial Training Worksheet Form #775 shall be completed. This training shall include, but not be limited to:

- a review of firearms safety rules;
- a review of safe firearms handling procedures;
- a review of Agency use of firearms and deadly force policy; and
- live fire exercises.

Upon completion of the training the employee will submit a Report of Training Form #182, through the chain of command to the Training Division. The Chief Firearms Instructor will evaluate the effectiveness of the training and document his conclusions in memorandum form and forward it through the chain of command to the Commander, Training Division, the employee's commander and the Commander, OPR.

**3-820.18 SHOTGUNS**

Any shotgun carried by employees in their official capacity shall be approved by the Chief Firearms Instructor or his designee. Any employee carrying a shotgun will have received a police shotgun basic training course. The shotgun shall be of a pump/ slide action only and shall be equipped with a sling which has been approved by the Chief Firearms Instructor or his designee. It shall be designed to chamber 12-gauge ammunition. The shotgun shall conform to the minimum length requirements set by the National Firearms Act and have a minimum magazine capacity of 4 rounds. A shotgun with a barrel of less than 18 inches or overall length of less than 26 inches is subject to the National Firearms Act.

The Chief Firearms Instructor or his designee shall examine all off-duty shotguns presented for qualification to determine they meet the Agency requirements and are in good condition for use. No shotgun which is judged to be in unserviceable condition, or which does not meet Agency requirements, or is for any reason deemed not appropriate to use as an Agency shotgun, will be used in qualification.

Ammunition carried for the shotgun by the employee while performing in his official capacity shall be Agency issued ammunition. Members of the Emergency Services Team may have other ammunition approved for use in their capacity as Emergency Services Team members.

Shotguns shall be carried in the "cruiser safe" condition (magazine loaded, hammer down on an empty chamber, safety on) when they are being transported within a vehicle. All employees who use a shotgun in their official capacity will receive annual training and an annual qualification course.



Administrative and Operational Manual

September 12, 2022

---

### 3-820.19 EMERGENCY SERVICES TEAM FIREARMS

Guidelines on EST procedures regarding firearms can be found in the EST SOP.

### 3-821 AGENCY RIFLES

Carrying an Agency rifle is a voluntary, additional weapons platform available to sworn officers.

All rifles shall be Agency issued, iron sighted and, either 5.56 / .223, capable of semi-automatic fire only. The Chief Firearms Instructor or his designee will determine the acceptability of a specific rifle for Agency purchase. No Agency rifle shall be equipped with any form of silencing device or scope.

Rifles shall be equipped with a sling which has been approved by the Chief Firearms Instructor or his designee. A rifle with a barrel length of less than 16 inches or overall length of less than 26 inches is subject to the National Firearms Act. All rifle magazines for duty use shall be loaded 2 less than maximum capacity (for example, 28 rounds in a 30-round magazine).

If an employee fails to comply with the required policy regarding carrying an Agency rifle, that employee's rifle shall be removed and reassigned as needed.

#### 3-821.1 TRAINING AND QUALIFICATION

Officers who carry an agency rifle must successfully complete special weapons entry-level training as mandated by the Maryland Police Training and Standards Commission. This entry-level training must include a minimum of six (6) hours of classroom instruction and a minimum of 350 practice / qualifying rounds before being authorized to carry an Agency assigned rifle. Upon rifle issuance, semi-annual qualification will commence consisting of 50-round courses of fire.

All sworn officers shall qualify with the rifle they are assigned and must qualify with a score of at least 90% accuracy. Any qualification score under 90% will result in the mandatory relinquishment of the rifle.

When officers fail to meet the minimum score in qualifying as established by the Charles County Sheriff's Office, the following procedures shall be followed:

- the Chief Firearms Instructor shall notify the officer's commander;
- the Chief Firearms Instructor or his authorized designee will take possession of the officer's Agency rifle; and
- the Chief Firearms Instructor will coordinate the rescheduling of a range date and remedial training as needed.

Officers carrying an Agency rifle shall receive annual in-service rifle training as approved by the MPTSC. Supervisors not in the program will receive familiarization training on the rifle and the program.

All records of qualification and training will be maintained by the Chief Firearms Instructor and/or his authorized designee. All courses of fire will be in conjunction with the mandated Maryland Police Training and Standards Commission's qualification guidelines.

#### 3-821.2 RIFLE DEPLOYMENT GUIDELINES

The decision to deploy a rifle shall be in conformance with the training provided and based upon the information and resources available to the officer at the time (the risks created by the use of the rifle and the danger posed by



Administrative and Operational Manual

September 12, 2022

the suspect).

Scenarios in which trained and qualified officers may use rifles include, but are not restricted to:

- provide immediate tactical response to calls involving armed and/or violent offenders;
- increase citizen and officer safety during high-risk incidents;
- provide for more accurate and controlled shot placement;
- penetrate ballistic body armor;
- perimeter / containment situation involving a hostage situation and/or barricaded subject;
- response to an active shooter;
- high risk traffic stop;
- incident where an officer has reasonable expectation that there is a potential for an armed subject encounter;
- provide cover for a police K-9, or another officer, in the search for an armed subject;
- upon request of a supervisor for an extraordinary event.

Officers shall always consider the potential consequences of their actions when making the decision to use a rifle.

### 3-821.3 TRANSPORTATION AND STORAGE

Rifles will be kept in one of three ways:

**Cruiser Ready Condition:** The rifle will be kept in the cruiser ready condition on duty and at all times when not deployed and charged. The following describes the cruiser ready condition:

- magazine inserted or readily accessible;
- bolt forward on an empty chamber;
- selector switch on SAFE; and
- secured in an Agency issued or Agency approved case or gun box as approved by the Chief Firearms Instructor or his designee.

**Charged Condition:** The rifle will be placed in the charged condition when deployed for training or duty. The charged condition is as follows:

- magazine inserted;
- round chambered in the rifle; and
- selector safety on SAFE until ready to fire.

**Armory Condition:** The rifle will be placed in the armory condition when the rifle is going to be inspected, checked for maintenance or on a break on the shooting line. The armory condition is as follows:

- magazine removed;
- bolt locked to the rear;
- selector switch to SAFE; and
- ejection port visible.

### 3-821.4 MAINTENANCE AND CARE OF RIFLES

Officers are responsible for the periodic cleaning and lubrication of their assigned rifles in accordance with their training.





**Administrative and Operational Manual**

**September 12, 2022**

Other than cleaning and lubrication, only the Chief Firearms Instructor or his designee shall perform maintenance on any rifle.

Damage or mechanical failure will be reported to the Chief Firearms Instructor or his designee so appropriate action can be taken.

Failure to properly maintain an assigned rifle may result in reassignment of the rifle.

All rifles will be required to be inspected by the Chief Firearms Instructor or his designee once a year. The Chief Firearms Instructor or his designee will be responsible for the collection and timely return of the rifles to the designated officers. The Chief Firearms instructor shall maintain written records of all maintenance and inspections of each rifle.

All rifles will be inspected monthly for cleanliness, visual damage and proper lubrication by the officers' supervisors, with the results being noted in the comment section on the bottom of the Monthly Personnel & Vehicle Inspection Form #75.

### **3-830 USE OF WEAPONS OTHER THAN FIREARMS**

Except in deadly force situations, employees should only use the instruments provided by the Agency, in accordance with Agency training and policy. The employee shall be responsible for articulating the necessity of the use of any other instrument, and the use will be evaluated for compliance with Agency policy pertaining to the use of force.

#### **3-830.1 BATONS**

A collapsible baton is issued or approved by the Training Division and will be used in accordance with Agency training and policy. When applying force with a baton, employees shall utilize the techniques taught in the Agency training program for that weapon. Initial baton training will occur before the employee is authorized to carry and biennial training will occur for all authorized carriers.

#### **3-830.2 AEROSOL SUBJECT RESTRAINTS (ASR)**

Only Agency issued chemical ASRs will be used by employees.

ASRs are authorized for use in circumstances where force is justified. The choice to use an ASR is to be based upon the evaluation of weapons and techniques available to accomplish the task at hand.

All ASR use shall be in accordance with the methods, techniques and policies of the training program for the weapon.

When an ASR has been used, it shall be immediately turned in for replacement.

#### **3-830.3 CHEMICAL WEAPONS**

Information concerning Chemical Weapons and the deployment of Chemical Weapons can be found in the EST and SERT SOP manuals.

#### **3-831 CONDUCTED ENERGY WEAPONS (CEWs)**



**Administrative and Operational Manual**

**September 12, 2022**

The objective of this policy is to provide direction with regard to use and reporting of the Conducted Energy Weapon (CEW) as it applies to Agency Use of Force policies and when used in accordance with guidelines as taught in initial and in-service training. Only an Agency-owned CEW shall be authorized for use by the Charles County Sheriff's Office.

**3-831.1 TRAINING AND USE**

Only officers who have received the required training and certification are authorized to carry or use the CEW. Responsibility for the management of the Agency CEW program is assigned to the CEW Coordinator. The CEW Coordinator will be designated by the Commander, Training Division. The CEW Coordinator shall be a certified instructor with all CEW devices.

Re-certification will occur once a year as scheduled by the Commander, Training Division. An officer who cannot fulfill the training requirements will not be authorized to carry or use the device.

Officers shall take into consideration known physical or mental conditions which potentially could increase the likelihood of injury to the individual if the CEW is deployed.

**3-831.2 WEAR AND CARRY / CARE AND MAINTENANCE OF THE CEW**

With the exception of EST personnel, who, due to tactical needs, are authorized to carry the CEW elsewhere, all authorized users shall carry the CEW in an Agency authorized holster on the weak hand side opposite from the duty firearm. The CEW, when not being worn by the officer, should be stored in the holster and transported in a safe and secure location. When stored, the CEW should be secured in a safe location.

To ensure proper functioning and to ensure that the device is free of dirt and other debris that may affect its reliability, the CEW shall be subjected to a full 5-second "spark / functionality test" as defined in training to ensure that the device is functioning properly. This "spark / functionality test" shall be completed prior to the start of each officer's work week.

Only authorized individuals will make any modifications to the CEW or its holster.

**3-831.3 USE OF A CEW**

The most frequently utilized mode of the CEW is the Probe Mode, which is designed for incapacitation of an individual and preventing officer-individual physical contact. When deployed, a CEW cartridge produces a loud popping sound which could be mistaken for a gun shot. Therefore, whenever possible, an officer who is about to deploy a CEW will give a loud verbal warning prior to firing this device by shouting the word "Taser!" This verbal warning achieves two purposes:

- It gives the subject a final warning that his / her actions are dictating the use of a CEW device; and
- It warns other officers and bystanders the device is about to be deployed.

When practical, officers shall target the lower center mass (below the chest) for front shots and below the neck area for back shots. Officers shall avoid targeting the individual's groin, neck, face, hands, feet, upper chest, or anywhere on the head with the CEW.

An officer shall use a CEW only when presented with an exigency the officer believes creates an immediate threat of physical injury and that is reasonably likely to be cured by using the CEW.

After a deployment, officers should reassess the situation and evaluate whether additional deployments are necessary. Where practical, no more than one CEW should actively deliver an electrical charge against an



Administrative and Operational Manual

September 12, 2022

individual at one time. Once used, the deploying officer will direct the actions of other assisting officer(s) on the scene in handcuffing the subject.

If application of a CEW appears to be ineffective, officers must consider the reasonableness of applying subsequent bursts and consider other methods of gaining control and compliance from a subject.

Officers should use a CEW for one standard 5-second cycle and then evaluate the situation to determine if subsequent cycles are necessary. Exposure to the CEW for longer than 15 seconds (whether due to multiple applications or continuous cycling), may increase the risk of death or serious injury.

Officers are permitted to “paint” an individual with the laser sight in an effort to gain compliance to orders. However, officers shall not intentionally point the laser into an individual’s eyes. Officers are also permitted to spark the weapon in an effort to gain compliance.

The Drive Stun Mode is used primarily to complete the circuit to achieve NMI. The Drive Stun Mode can also be used as a pain compliance tool when faced with active aggression.

A CEW will not be used to unlawfully threaten, coerce, harass, taunt, or abuse any person. Any form of horseplay using a CEW is prohibited.

Officers may consider deploying a CEW when confronted with aggressive animal attacks.

The pulse from a CEW is strong enough to ignite flammable substances such as gasoline, kerosene, etc. A CEW will not be used if there is reason to believe the individual or the individual's clothing has been exposed to a flammable substance. Officers should also be aware that some OC sprays are alcohol-based and are possibly flammable. However, the Pepper Spray currently issued by the Agency is CEW compatible. Certified officers may carry both the OC spray and the CEW.

### 3-831.4 POST DEPLOYMENT CONSIDERATIONS

All individuals who have received a discharge from a CEW should be restrained in a manner and position that does not interfere with their breathing.

The CEW darts may be removed from the subject after being restrained, following procedures outlined in training. The CEW darts should be treated as a biohazard risk.

Personnel are not required to request EMT response unless one or more of the following applies:

- the individual requests medical attention, or there is an obvious need for medical attention;
- the individual is hit in a sensitive area (for example, eye, face, head, breasts, genitals);
- the officer has difficulty removing the probes;
- the individual does not appear to recover in a reasonable period of time after being exposed, as determined by the officer following training guidelines;
- the individual is part of a sensitive population group as described in this policy;
- the individual has been exposed to more than three CEW cycles;
- the individual has been exposed to the effects of more than one CEW device;



**Administrative and Operational Manual**

**September 12, 2022**

- the individual is reasonably believed to have been exposed to a continuous cycle of 15 seconds or more;
- the individual has exhibited signs of "excited delirium," as outlined and defined in training, prior to and/or during CEW exposure.

If the probes penetrate the flesh, photographs of the contact area should be taken after they are removed. When the device has been used operationally, the officer shall collect the cartridge, wire leads, and darts, and secure them as evidence.

Any deployment of a CEW will require spent cartridge(s) and probes to be collected and submitted to Property Held by the deploying employee. The owner will be the Charles County Sheriff's Office, and the notation that the property will be kept for a minimum of thirty-seven (37) months will be included in the narrative portion of the report.

An officer who deploys a CEW will request a supervisor who is trained and certified to download the stored firing data from the CEW. This data can aid in protecting the employee and the Agency from false allegations of misuse of the CEW. This step will be accomplished within 72 hours of the field use. When a CEW's stored data is downloaded, it will be the responsibility of the downloading supervisor to forward this written data to the Office of Professional Responsibility to be attached to the related Use of Force Report. The supervisor should review the incident and ensure that all aspects of the CEW protocol and policy have been followed.

Unintentional deployments of a CEW, where no one was affected by the device, will be documented on a memorandum, forwarded to the Commander, OPR and Commander, Training Division. The memorandum will include the date, time, and the circumstances of the deployment.

### **3-832 STUN-CUFFS**

The Stun-Cuff system is assigned to the Special Services Division and is maintained in accordance with SOP directives.

### **3-835 FN-303 PROJECTILE LAUNCHER**

The FN-303 Projectile Launcher is designed to launch a fin-stabilized projectile by the means of compressed air to a maximum effective range of 55 yards. A projectile striking an offender will first deliver kinetic energy in an attempt to modify or control threatening behavior. The same projectile will also contain powder Oleoresin Capsicum (OC) chemical agent as a secondary effect to the kinetic energy strike. The use of the FN-303 is categorized as non-lethal force and may be used to control a dangerous or violent subject when:

- lethal force does not appear to be justified;
- attempts to control the subject by other conventional tactics have been ineffective; and/or
- there is reasonable expectation it is unsafe for officers to approach within contact range of the subject.

#### **3-835.1 TRAINING**

Only officers who have received the required training and certification with the specific launcher (FN-303 Projectile Launcher) are authorized to carry or deploy the weapon. This training will be documented and monitored by the Training Division. Recertification will occur and be documented annually and those who cannot maintain the training requirements will relinquish the weapon.-

#### **3-835.2 STORAGE AND MAINTENANCE**



**Administrative and Operational Manual**

**September 12, 2022**

Officers who are issued the FN-303 are required to maintain it just as they would any other weapon. The FN-303 will be stored in a case when not in use. Only officers who have received training in their use are allowed to utilize the FN-303 during their tour of duty. The FN-303 Armorer will be responsible for the regular inspection and maintenance of the equipment.

The officer is responsible for:

- ensuring the air reservoir is charged;
- ensuring issued OC rounds are serviceable and operational;
- dry firing the system;
- ensuring proper overall condition of the weapon.

Officers authorized to deploy the FN-303 will not disassemble or tamper with the internal mechanisms. Any repair for malfunction, damage, or parts replacement will be completed by an FN-303 Armorer.

### **3-835.3 OPERATIONAL GUIDELINES**

A loud verbal warning “Launcher” will be given by the officer prior to deploying the weapon. This warning will fulfill two (2) purposes:

- It will provide aggressive subjects a final warning their actions are dictating the use of the device; and
- It will give notification to officers and bystanders on the scene the device is about to be discharged.

The preferred target area when deploying the FN-303 should be center mass of the body between the neck and groin or the large muscles in the legs. Attempts should be made to target clothed areas of the body. Officers are reminded individuals tend to bend over and turn after being struck with non-lethal projectiles. Officers should be prepared to aim lower if follow up applications are needed.

Under normal circumstances the FN-303 should not be deployed if the officer is within 12 feet of the recipient. If the officer deploys the FN-303 within 12 feet, the recommended target area is the thighs.

The deploying officer will be responsible to direct the actions of any other on-scene personnel concerning the restraint of the subject. Assisting personnel should allow a few moments, if practical, for the chemical agent to take effect prior to making any arrest.

When a suspect is apprehended who has been impacted by an FN-303 projectile, a medical evaluation will be conducted as soon as reasonable.

Deployment of the FN-303 on large- to medium-sized aggressive animals is authorized. The body of the animal is the preferred target area. If the owner of the animal can be located, the owner should be notified of the deployment by the operator of the FN-303.

### **3-837 USE OF FORCE REPORTING**

#### **3-837.1 USE OF FORCE REPORTING REQUIREMENTS**

In addition to any other report that may be required based on the nature of the incident, use of force reports shall be completed in Blue Team when any level of force is applied, according to the following guidelines.



**Administrative and Operational Manual**

**September 12, 2022**

**Call Sheet Only (Show of Force):**

- Display of a firearm or any instrument. An involved officer will notify Communications of the type of display, the officer(s) who displayed the firearm or other instrument, and the race and gender of the recipient(s). This event will be a companion to the event the officer(s) are on/responding to.
- K-9 deployment with no physical contact. An involved officer will notify Communications of the type of deployment, the officer(s) and K-9(s) deployed, whether the K-9 was on-lead or off-lead during the deployment, and the race and gender of the recipient(s). This event will be a companion to the event the officer(s) are on/responding to.
- For show of force incidents involving large crowds, the officer is not required to notify Communications of the race and gender of the recipients. However, a call sheet should still be completed to document the incident.
- In cases involving more than one officer or more than one recipient, the officer is only required to complete one companion event call sheet.

**Officer Report Only:**

- The utilization of a pressure point, joint lock, pain compliance technique or takedown on a resisting person or physical contact by a K-9 which has been deployed with no injuries.
- The involved officer will complete a use of force report by the end of shift, which will be reviewed by a supervisor and forwarded through the chain of command.

**Supervisor Investigation Required:**

- The attempt or actual use of physical strikes, stuns, impact weapon, CEW/ taser, chemical agent or other instrument on a person, or any complaint of injury from the officer or recipient of force. The deployment of a K-9 resulting in injury or complaint of injury of a recipient of force. Forced stopping or intentional collisions under AOM 4-302.10.
- The involved officer will complete a use of force report by the end of shift. A supervisor will conduct an investigation on the use of force and forward it through the chain of command.

**Criminal Investigation Required:**

- CID shall conduct a criminal investigation when the use of force involves the discharge of a firearm or when the use of force results in serious physical injury or death.
- The Office of Professional Responsibility shall complete the use of force report.

**Administrative Investigation Required:**

- The Office of Professional Responsibility shall conduct an administrative investigation when a use of force results in serious physical injury or death. However, the Office of Professional Responsibility may conduct an administrative investigation of any use of force and can refer any use of force incident to the Criminal Investigations Division for further investigation.

**Other Situational Requirements:**

- If the employee, due to the circumstances of the incident, is unable to complete the use of force report, the supervisor assigned to investigate the incident shall complete all necessary reports for the employee. In all cases, the reports shall be completed by the end of the involved officer's shift.



**Administrative and Operational Manual**

**September 12, 2022**

- For incidents involving multiple officers using reportable force, each individual officer using force must complete a separate use of force report. The overall use of force incident, however, may be captured in one supervisory investigation.
- For incidents involving more than one recipient (e.g., the Emergency Services Team introducing a chemical agent into a residence inhabited by several individuals), the employee introducing the agent would complete the use of force report. All recipients would be identified and listed in the report.
- In situations where the identity of a recipient cannot be obtained (e.g., a large crowd where some recipients have fled the scene), the officer should select “Unknown – Large Crowd” as the recipient.

**Review and Dissemination of Use of Force Reports:**

- The Office of Professional Responsibility will direct a copy of use of force reports involving sworn officers to Records Management to be placed in the general case file for the related incident.
- The Office of Professional Responsibility, Office of the General Counsel and the Training Division will review all use of force reports.

**3-837.2 USE OF FORCE REPORTING RESPONSIBILITIES**

**OFFICER RESPONSIBILITIES:**

The involved officer will notify communications, a supervisor and, if outside of Charles County, notify the local jurisdiction first.

**During call sheet only incidents, officers will have the following responsibilities:**

- Notify Communications of the type of display, the officer(s) who displayed the firearm or other instrument, and the race and gender of the recipient(s). This event will be a companion to the event the officer(s) are on/responding to.
- In the case of a K-9 deployment with no physical contact, notify Communications of the officer(s) and K-9(s) deployed, whether the K-9 was on-lead or off-lead during the deployment, and the race and gender of the recipient(s). This event will be a companion to the event the officer(s) are on/responding to.
- For show of force incidents involving large crowds, the officer is not required to notify Communications of the race and gender of the recipients. However, a call sheet should still be completed to document the incident.
- In show of force incidents involving more than one officer or more than one recipient, the officer is only required to complete one companion event call sheet.
- The supervisor will be notified of the incident. An acknowledgement over the radio will be sufficient. This information will be documented on the call sheet.

**During incidents that require an officer report, officers will have the following responsibilities:**

- The involved officer will complete a use of force report by the end of shift, which will be reviewed by a supervisor and forwarded through the chain of command;
- Detailed photographs of the recipient of force are taken, regardless of injury. If the person is not in custody and refuses to submit to the taking of photographs, this fact shall be noted in the report; and
- Document the recipient(s) of force, complainants, witnesses and all involved employees.

**During incidents that require supervisory investigation, officers will have the following responsibilities:**



**Administrative and Operational Manual**

**September 12, 2022**

- The involved officer will complete a use of force report by the end of shift.

**During incidents that require criminal investigation, officers will have the following responsibilities:**

- The involved officer may be required to give a public safety statement, a general overview of events that occurred, to a supervisor; and
- Surrender any instrument used when needed for evidentiary purposes.

**SUPERVISOR RESPONSIBILITIES:**

**During call sheet only incidents, supervisors will have the following responsibilities:**

- Ensure Communications was notified of the type of display and that the officer(s) who displayed the firearm or other instrument and the race and gender of recipients were identified in the call sheet.
- In the case of a K-9 deployment, ensure Communications was notified, the officer and K-9 deployed were identified, and the race and gender of recipients were documented in the call sheet.
- Notify responsible commander of the incident.

**During officer report incidents, supervisors will have the following responsibilities:**

- Contact the individual employee, respond to the scene when practical;
- Review the report;
- Ensure all rules, regulations and policies related to the reporting of such incidents are complied with;
- If the recipient of force(s) is a juvenile and their identity is known, it is the responsibility of the supervisor to notify the juvenile's parents or legal guardian of the circumstances as soon as it is safe and practical. This notification will be made regardless of whether or not the juvenile is arrested; and
- Notify the responsible commander of any reportable use of force as soon as practical.

**During incidents that require supervisory investigation, supervisors will have the following responsibilities:**

- Initiate a use of force investigation immediately;
- Ensure detailed photographs are taken of the recipient of force and the officer, regardless of injury. If the person is not in custody and refuses to submit to the taking of photographs, this fact shall be noted in the report;
- Review the report;
- Ensure all rules, regulations and policies related to the reporting of such incidents are complied with;
- Ensure that any video of the event has been identified and proper procedures within policy and law to preserve and obtain video that has been taken;
- Interview the recipient(s) of force, complainants, witnesses and all involved employees;
- If the recipient of force(s) is a juvenile and their identity is known, it is the responsibility of the supervisor to notify the juvenile's parents or legal guardian of the circumstances as soon as it is safe and practical. This notification will be made regardless of whether or not the juvenile is arrested; and
- Notify the responsible commander of the status of the incident.

**In instances where a use of force incident involving an officer occurs outside Charles County, supervisors will have the following additional responsibilities:**

- Notify the responsible commander of the status of the incident;
- Respond as assigned;





**Administrative and Operational Manual**

**September 12, 2022**

- Gather information and copies of local reports;
- Act as a liaison between the local agency and CCSO;
- Protect the interests of the involved employee and the Agency to the highest degree possible;
- Take custody of Agency property as necessary; and
- Request additional assistance as needed.

**SHIFT/SECTION COMMANDER RESPONSIBILITIES:**

**During call sheet only incidents, shift/section commanders will have the following responsibilities:**

- Review the call sheet, if necessary.

**During officer report incidents, shift/section commanders will have the following responsibilities:**

- Assign a supervisor to respond to the scene.

**During incidents that require supervisory investigation, shift/section commanders will have the following responsibilities:**

- Coordinate and control initial response, if necessary;
- Assign a supervisor to respond to the scene;
- Make the following notifications as required.
  - Possible violations of Agency policy:
    - Office of Professional Responsibility (OPR), and
    - Involved employee's Division Commander / Director.
  - Possible criminal violations, or incident involving serious injury or death:
    - Involved employee's Division Commander / Director,
    - CID, and
    - OPR.

**DIVISION COMMANDER/DIRECTOR RESPONSIBILITIES**

**During officer report incidents, division commanders/directors will have the following responsibilities:**

- Review the officer report, if necessary.

**During incidents that require supervisory investigation, division commanders/directors will have the following responsibilities:**

- Review the supervisory investigation, if necessary.

**During incidents that require CID investigation, division commanders/directors will have the following responsibilities:**

Make notifications to the following list of people:

- Sheriff,
- Chief of Staff,
- Assistant Sheriff,



**Administrative and Operational Manual**

**September 12, 2022**

- Commander, Executive Services, and
- General Counsel.

**During incidents that require OPR investigation, division commanders/directors will have the following responsibilities:**

Make notifications to the following list of people:

- Sheriff,
- Chief of Staff,
- Assistant Sheriff, and
- Office of the General Counsel.

**CRIMINAL INVESTIGATIONS DIVISION RESPONSIBILITIES**

- CID shall conduct a criminal investigation when the use of force involves the discharge of a firearm or when use of force results in serious physical injury or death.

**OFFICE OF PROFESSIONAL RESPONSIBILITY RESPONSIBILITIES**

- When a CID investigation is required, OPR will complete the use of force report.
- The Office of Professional Responsibility shall conduct an administrative investigation when a use of force results in serious physical injury or death. However, the Office of Professional Responsibility may conduct an administrative investigation of any use of force and can refer any use of force incident to the Criminal Investigations Division for further investigation.

**3-838 FATAL OR SERIOUS PHYSICAL INJURIES**

Any employee whose action(s) or use of force in an official capacity results in death or serious physical injury will be referred to an Agency psychologist/psychiatrist for evaluation and consultation. In no case will an employee return to work until an initial counseling session has been attended and the employee's ability to perform his duties has been determined. It shall be the responsibility of the Commander, Administrative Services to see this session occurs as quickly as possible, preferably within twenty-four (24) hours of the occurrence of the event.

**3-839 INJURED WILD ANIMAL TERMINATION**

On occasion, officers of this Agency are called upon to terminate the lives of injured wild animals. Most often, wild animals are injured as a result of highway accidents.

In cases where the animal's injuries are severe, causing unnecessary suffering, or have caused the animal to be a threat to itself, other animals or humans, the animal shall be terminated.

In cases necessitating the termination of an injured wild animal, the officer shall have Communications start an event for "Destroyed Wildlife." The officer will have Communications make note on the call sheet specifying the firearm used and the number of rounds expended to terminate the animal.

No Incident Report or Use of Force / Discharge of Firearms Report is required when Agency guidelines are followed to terminate an injured (non-domesticated) wild animal.



Administrative and Operational Manual

September 12, 2022

---

Should damage occur to property other than the injured wild animal, the officer shall complete an Incident Report detailing the circumstances surrounding the event, the property damaged and property owner information, if applicable.

### **3-840 USE OF FORCE ON DOMESTIC ANIMAL**

It is unreasonable for a police officer to use force on a privately owned animal when it does not pose an immediate threat to the officer or others. In cases where an officer uses force on a domestic animal an Incident Report (not a use of force report) shall be completed. The Incident Report for "Domestic Animal" shall include details surrounding the event and the reason for the force.

A supervisor will be notified at the time of the use of force.

### **3-841 VICIOUS OR DANGEROUS ANIMALS**

Any dog or other animal, which, without provocation, has attacked, bitten or injured any human being, or other animal, or which has a known propensity to attack or bite human beings is defined to be a vicious / dangerous animal [see Charles County Code (230-12.5) for full legal definition]. When an officer receives a complaint of a vicious or dangerous animal, he shall submit an incident report with a note for a copy to be forwarded to the Charles County Animal Control Division. Routine animal complaints will be directed to the Charles County Animal Control Division during regular business hours. The Communications Section will forward a copy of the call sheet on each of these incidents.

When other means to control vicious or dangerous animals have been ineffective, unavailable or clearly inappropriate in the instant circumstances, an officer may resort to the use of a firearm to apply deadly force to protect himself, or another person, from the threat posed by the vicious or dangerous animal. When such action is taken the officer will notify a supervisor and complete an incident report detailing the circumstances of the firearms use.

Supervisors who are notified as a result of these events, will evaluate the circumstances to determine the need for command, CID or OPR notification and/or response. If such action is required, the supervisor will coordinate these activities and, at a minimum, will see that the Incident Report and a Commander's Report are completed in a timely manner.

### **3-842 SUSPECTED RABID ANIMALS**

When an officer is confronted with a situation involving a suspected rabid animal (bats included), the officer will attempt to confine the animal to prevent the animal from escaping, if the officer can do so without placing the officer or anyone else in a position to receive a bite or come in contact with the animal. In determining whether an animal is safely confined or not, it must be remembered that wild animals possess cunning instincts which increases the probability of escape; whereas, many domestic animals can be safely confined on the owner's premises or property with only a remote possibility of escape. When wild animals are involved, the officer must not be hesitant to take definitive action to prevent the animal from escaping or gaining a position which poses a greater threat to human safety.

If any wild or suspected rabid animal has had any physical contact with any human or domestic animal, the officer



Administrative and Operational Manual

September 12, 2022

will utilize any resources at the officer's disposal, to include shooting the animal, to prevent the animal from escaping. In cases involving wild animals that have had any physical contact with any human or a domestic animal, the wild animal will be confined or destroyed. Environmental Health shall be notified by the officer handling the incident and a notation shall be placed on the report noting the name of the person, at Environmental Health, receiving the notification. The officer may obtain call-out information from the Communications Section supervisor who shall maintain that current information.

### 3-842.1 SHOOTING OF RABID ANIMALS

When an officer is confronted with a situation involving a possible rabid animal that cannot be safely confined or captured by the Charles County Animal Control Division and there is a possibility that the animal can escape, the officer will destroy the animal, preferably by shooting it after weighing all safety factors. When killing the animal, care should be taken to preserve the brain, if possible.

### 3-842.2 RESPONSIBILITIES SUBSEQUENT TO SHOOTING RABID ANIMALS

Once a suspected rabid animal has been killed, the officer will:

- neither touch the animal nor allow anyone else to touch it, without the use of protective gloves; and
- take measures to ensure that children or other animals do not come in contact with the carcass; and
- in cases where the animal has bitten or had contact with a person or a domestic animal, notify the Environmental Health Division to respond and recover the animal for testing; and
- in the case of wild animals where there was no contact with humans or a domestic animal, contact the Environmental Health Division in order to have them call the property owner with instructions (generally on how to bury or bag the animal); or in the case of an animal on public property, to make arrangements to immediately recover the carcass.

No report of investigation or Use of Force Report is required when Agency guidelines are followed to kill a suspected rabid animal, unless direct human contact or an indirect contact through a domestic animal was possible.

In cases necessitating the termination of a suspected rabid wild animal, the officer shall have the Communications Section start an event "Destroyed Wildlife." The officer will have the Communications Section make note on the call sheet specifying the firearm used and the number of rounds expended to terminate the animal.

Should damage occur to property other than the suspected rabid animal, the officer shall complete an incident report detailing the circumstances surrounding the event, the property damaged and property owner information (see Use of Force policy elsewhere in this Manual).

### 3-842.3 ADDITIONAL RESPONSIBILITIES IN RABID ANIMAL CASES

In all situations involving rabid animals or animals that exhibit the symptoms of being rabid, the officer will:

- make an extra effort to locate the animal if the animal is not present when the officer arrives on the scene; and
- detour citizens from the area to prevent them from coming into contact with the animal; and
- make every effort to contain the animal if the officer can do so safely without placing himself or anyone else in a position to receive a bite or come in contact with the animal; and
- ensure that the animal does not escape or in any way endanger the officer or the community; and
- notify the Animal Control Service and remain on the scene until the Animal Control Services personnel arrive; and
- notify the Environmental Health Division.

The police officer's role is crucial to prevent the spread of rabies, and it is mandatory that officers be responsive to



Administrative and Operational Manual

September 12, 2022

prevent the disease from infecting the human population.

### **3-850 FIREARMS QUALIFICATION FOR RETIRED LAW ENFORCEMENT OFFICERS**

The following policy is created with respect to the Federal Law Enforcement Officers Safety Act of 2004 (18 U.S.C. § 926 B and C). In order to accommodate the provision of that law allowing law enforcement officers to carry firearms nationwide if they qualify annually, the following qualification provisions are adopted by this Agency.

#### **3-850.1 QUALIFICATION OF RETIRED OFFICERS**

Whenever resources permit, firearms instructors of this Agency may conduct firearms qualifications for retired officers of this Agency. Retired officers of other agencies may be qualified at the discretion of the Sheriff. It is the responsibility of the retired officer to ensure that they meet the requirements of 18 U.S.C. § 926 and will complete and sign the Retired Officers Qualification Application and Affidavit Form #72A prior to qualifying. The firearms qualification will be conducted using current Maryland Police Training and Standards Commission (MPTSC) firearms qualification standards.

A retired officer will be qualified using a type of firearm which that officer has previously qualified with in a duty status prior to retirement. All retired officers will attest to this fact using the Form #72A, prior to the retired qualification.

Retired officers must be capable of qualification when they report to the range, and range instructors will provide only one opportunity per firearm type on any single range date. If conditions permit, a retired officer may qualify with two firearms. No more than two firearms will be allowed per range date.

#### **3-850.2 FIREARMS AND AMMUNITION FOR RETIRED OFFICERS QUALIFICATION**

All firearms and ammunition will be provided by the individual officer seeking qualification. Firearms and ammunition must be approved by the range instructor before qualification.

#### **3-850.3 FEE FOR QUALIFICATION**

The retired officer may be required to pay the CCSO a fee to offset the use of the range facility and the instructor time used for the qualification process. This fee must be paid by check or money order made to the CCSO prior to qualification. This fee is non-refundable without consideration as to the retired officer's successful qualification or lack thereof. This fee will be set from time to time as dictated by the costs associated with the process. If more than one firearm is used in the process, a fee will be paid for both.

#### **3-850.4 QUALIFICATION CARDS FOR RETIRED OFFICERS**

A Qualification Card Form #72 will be issued by the qualifying firearms instructor to each applicant who fires a qualifying score. Qualification cards issued to retired officers will contain the following information:

- the date the qualification occurred;
- the manufacturer of each firearm used;
- the serial number of each firearm used;
- the model of each firearm used;
- a statement that the qualification was conducted in accordance with current standards of the Maryland Police Training and Standards Commission;
- the qualifying score;



**Administrative and Operational Manual**

**September 12, 2022**

- 
- the title of the Charles County Sheriff's Office as the entity conducting qualification; and
  - the name and signature of the range instructor conducting the qualification.

### **3-850.5 RETIRED OFFICER QUALIFICATION APPLICATION FORM #72A USAGE**

When a retired law enforcement officer wishes to qualify with a firearm, that person will complete a Retired Officer Qualification Application and Affidavit Form #72A. The completed form will be forwarded to the Chief Firearms Instructor. The Chief Firearms Instructor will check the form and contact the applicant.

The applicant will be informed of any problems with the form and will be required to correct them. The applicant will be told the date and location to report for qualification and the number of rounds of ammunition to bring to the range for qualification. If the Chief Firearms Instructor wishes to check the firearms and ammunition prior to the applicant reporting to the range, such arrangements will be made during this contact.

The shaded areas on the form are to be completed by the firearms instructor. The witness at the bottom of the form may be any Agency employee who witnesses the completion of the form by the applicant.

The completed form will be sent to Records Management Section for filing for a period of four years. Records Section personnel will answer any inquiries from other law enforcement agencies during that period, and supply any information from the form.

### **3-850.6 COLLECTION OF QUALIFICATION FEES**

Firearms instructors will determine and collect the fee from the applicant prior to the beginning of a qualification session. The applicant will be given a receipt using the receipt book designated for this purpose. These fees, along with the original of the receipt, will be submitted to Deputy Director, Accounting Section by the end of the next business day following the qualification session.



Administrative and Operational Manual

September 12, 2022

## CHAPTER 4 – AGENCY OPERATIONS

### 4-100 COMMUNICATIONS SECTION

The basic function of the Charles County Sheriff's Office Communications Section is to receive, screen, and prioritize calls for service and subsequently dispatch the appropriate response units in an efficient and coordinated manner.

The Communications Section shall be staffed and operated on a twenty-four hour basis to provide continuous two-way communications and support services to all CCSO officers. Radio communications, whether voice, wireless data, or a combination of voice and data, is the primary method used by the Communications Section to relay information. Officers are issued a portable radio equipped with an automatic identification system that identifies the unit number to Communications. This radio shall be carried at all times while on duty.

Charles County Public Safety has the ability to conduct interoperable communications with all surrounding jurisdictions, between police, fire, marine, federal agencies, and jurisdictions in Virginia, either by switching talk groups (radio channels) or with the assistance of a Communications Officer "patch with another agency. These communications also include encrypted talk groups with other agencies.

All Agency radio operations will be conducted in accordance with Federal Communications Commission procedures and requirements. FCC regulations prohibit radio misuse such as profane language, inappropriate transmissions, intentionally "covering" other units, etc. Misuse of the radio is a serious and potentially dangerous breach of safety protocol and will not be tolerated. Idle conversation not related to police operations is prohibited, as it may interfere with operational transmissions and compromise officer safety. Supervisors are responsible for identifying individuals misusing the radio, and those found to be in violation would be subject to disciplinary action.

The Communications building is a secured facility and only authorized personnel on official business are permitted to enter. Visitors to the facility must log in and be escorted.

#### 4-100.1 DEFINITIONS

**Code 1 calls** - Members responding to non-emergency calls will respond immediately while observing all traffic laws.

**Code 2 calls** - These calls involve potentially life-threatening situations. Members responding Code 2 shall use lights and siren, and should turn on the vehicle's headlights. Members shall also comply with the provisions of the Transportation Article (TR § 21-106), for Emergency Vehicles. A minimum of two units will be dispatched on Code 2 calls.

### 4-101 COMMUNICATIONS PROCEDURES

Communication procedures for specific situations are covered throughout the AOM. Procedures outlined in this section are to be followed for most circumstances.

**Emergency Calls** - All "911" lines are to be answered by saying "Charles County 911." "911" lines are for emergency calls only. The County's "911" call taker is responsible for answering this line. If he is busy or on another line, the "911" line is to be answered by the following personnel in order:

- Fire / EMS Supervisor;
- Fire / EMS Dispatcher;
- CCSO Police Communications.



Administrative and Operational Manual

September 12, 2022

Every attempt shall be made to obtain the following minimum Information:

- exact location (a mailing address is not sufficient);
- nature of call;
- name of person calling and the name of their residence; and
- call back number.

A caller's refusal to identify himself will not preclude an attempt to assist the individual nor inhibit a response by an officer to a call for service.

Dependent upon the nature of the call, additional information should be obtained if appropriate:

- suspect identity and/or description;
- extent of injuries;
- whether or not weapons were involved and what type.

The common "911" caller may be highly distraught; some may be hysterical. The call taker should professionally, but firmly, take control of the conversation, obtain the necessary information, and advise the caller assistance is being dispatched.

**CCSO Non-Emergency Lines** - It shall be the responsibility of police station technicians at each district station to answer these lines. If they are unable to answer, these lines are to be answered by the police station technicians at the District I Station. If it becomes necessary to leave the telephones unattended and no one is immediately available to monitor them, police station technician personnel at the District I Station will be notified of their absence.

The call takers shall obtain as much information as possible when receiving a call for service. The amount of information required will depend on the nature of the call and the status of the requesting party. Particular attention must be committed to issues that involve the safety of officers who may be dispatched on the call. The call taker uses the CAD system to record the following minimum information:

- Name and address of the complainant, if possible;
- Type of incident (call type) being reported;
- Location of incident being reported.

After sending the call information to the PCO via the CAD, the call taker should stay on the line with the caller, if needed, to obtain additional information to pass along to the PCO.

**PCO Communications Procedures** - Upon receiving information, the Police Communications Officer (PCO) uses that information from the CAD system to dispatch the call. The CAD system automatically records the following entered information:

- Call for Service Number (CFS);
- Received Date and Time for the Call for Service;
- Identification of units assigned as primary and backup units;
- If there is a closer unit to the call, he shall give his location and may be reassigned as backup.
- The time the unit(s) was dispatched;
- The time of the unit's arrival;
- The time the unit returned to service.
- Disposition of dispatched incident as reported by the responding officer.

When dispatching an emergency call:





Administrative and Operational Manual

September 12, 2022

- the PCO will activate an emergency tone, notifying units of the forthcoming emergency message;
- the PCO will then announce the sector, brief description of the situation, location, assigned units, and assign it as Code 2.
- units will then acknowledge the call and advise where they are responding from. Additional units committing to the call will advise Communications of their location and their intentions concerning the call;
- the PCO will provide any other additional information such as look out details.
- if any other agency with units in the area of the incident acknowledges the call, Communications will advise if they are needed.

The PCO will attempt to notify the field supervisor of any calls of which they may need to be aware, or which may need the response of a supervisor.

Dispatching of non-emergency calls – Code 1 calls, absent exigent circumstances, will be dispatched as quickly as possible. To save on radio airtime, silent dispatch through the MDT for non-priority calls and all Animal Control calls will be used whenever possible. Additional information concerning the call may be provided by the MDT.

- The complainant will be notified, whenever possible, by a police station technician if there will be a delay in officer response to the call;
- Calls that have been held an extended length of time, or in case of numerous "stacked" calls, the street supervisor will be notified of the nature of calls holding; and
- Decisions on unit assignment shall be the responsibility of the PCO; however, the street supervisor holds the ultimate authority over assignment decisions.

**Police Communications Supervisors (PCS) Procedures** – Police Communications Supervisors shall monitor the radio system. They shall seek additional information for calls for service as needed or as requested. Nothing in this policy should prevent a PCS from seeking more information by telephone and consulting with the assigned officer(s) or a police supervisor about changing a call's status, or the number of officers assigned, etc. This is especially true for calls for assistance from the Detention Center.

**Officers Communication Procedures** - officers will be identified during radio transmissions by their assigned designator code and identification number. When going 10-8 officers shall announce their assignment for the day by sector and beat. Example: Adam 700, 10-8 in 1 Adam 2.

Officer radio transmissions will be made briefly and concisely using:

- Radio 10-Code;
- Phonetic alphabet (when necessary);
- Appropriate military time;
- Radio Completion Codes.

Radio messages are to be acknowledged promptly and officers should obtain necessary information (complainant's address, description of suspects, etc.) prior to acknowledging receipt of the message. This will save airtime and avoid redundancy in dispatching.

When contacting Communications by radio, officers will call using their full unit designation and wait for acknowledgement before continuing with a message to ensure dispatch is prepared to document information.



Administrative and Operational Manual

September 12, 2022

Officers will advise the PCO when:

- They switch from their primary radio frequency to another district's primary radio frequency (patrol officers only);
- They receive a report of a crime or incident in need of police attention;
- They arrive at the scene of a call for service;
- They are out of service for any reason; and
- They have returned to service.

Officers, when clearing a call, will be as brief as possible and refrain from using slang, unprofessional language, and unnecessary chatter.

The police radio system allows unit-to-unit communication between field units. Because any unit utilizing this system is effectively off the air for purposes of monitoring or receiving other radio traffic during that time, this feature should be used judiciously.

**Police Supervisors Communications Procedures** – Prior to field units beginning their shift, the unit rosters will be logged into a CAD terminal by a police supervisor or a designee. Supervisors should monitor the radio as much as possible. Supervisors may delay or cancel an assignment, change a response code, or reassign units under their command. Calls for service that have been delayed by a supervisor must be reassigned by him. In doing so, the supervisor assumes responsibility for the decision. If a supervisor feels the need for more information, he will contact the PCS by telephone.

**4-101.1 DESIGNATOR CODES - AGENCY PERSONNEL**

ID numbers will be continuously and sequentially assigned as new officers are employed. ID numbers vacated due to officers terminating employment will not be reassigned to employees; however, they may be assigned to a spare vehicle.

CCSO personnel are assigned designators based on their current assignment within the Agency. These designators will assist in quickly identifying an officer's assignment within the Agency. They are utilized as a prefix to personnel's assigned identification number:

Commissioned Officers	CAR	Traffic Operations Unit	TRAFFIC OPS
Sector Supervisors	PAUL	Canine Officers	K-9
Patrol Corporal	ADAM PAUL	Cadets	JOHN
Patrol Beat Officers	ADAM	Correctional Officers	CHARLES OCEAN
		Narcotics / Vice	VICTOR
Motorcycle Units	MOTOR	Criminal Investigations	ID
School Resource Officers	ROBERT	Training	TOM
Crime Prevention - Community Policing	DAVID	Special Services Officers	SAM

The Patrol District designations are:

District 1      La Plata



Administrative and Operational Manual

September 12, 2022

District 2 Indian Head  
District 3 Waldorf (East)  
District 4 Waldorf (West)

**4-101.2 DESIGNATOR CODES - NON- AGENCY PERSONNEL**

La Plata Police Department	La Plata
Animal Control	Animal Control / AOC
Fire Marshal	Frank Mary
Natural Resources Police	Nora Robert
Maryland Transportation Police	MTA
Federal Bureau of Investigation	FBI
MSP-Barrack Identifier	H/L +#
College of Southern Maryland	CSM 1 or 2 (emergency only)
Examples:	

"Frank-Mary-1168" - Fire Marshal #1168 calling Communications.

"La Plata-505" - La Plata Police Officer #505 calling Communications.

**4-101.3 JOINT OPERATIONS**

During joint traffic operations with another agency such as MSP or the Maryland Transportation Police, the CCSO officer(s) assigned to assist should remain on CSSO channel until preliminary requests are completed, the scene is stabilized, and the other agency arrives on the scene. Officers may then switch over and operate on the other agency's channel. For an incident being handled primarily by the CCSO with assistance from another agency, communications should be handled through our channels.

For all other joint operations such as warrant services and operations involving EST, the CCSO supervisor / commander shall determine whether to stay on our own channel or to switch to the other agency's channel. Communications will be notified either way.

For all multi-jurisdictional operations, all radio communications will be conducted using plain English. In order to maintain brevity and professionalism on the radio, the Agency will be using the definitions already established on the current 10-code list. For example, under the new system, instead of using 10-46, the user would state, "Assist Motorist".

**4-101.4 MOVING TO A TACTICAL TALK GROUP**

For prolonged incidents requiring uninterrupted communications, operations will be moved from the primary dispatch talk groups to a designated tactical talk group. This movement provides the freedom to manage the special circumstance, uninterrupted, for as long as necessary; and effectively allows for normal law enforcement activities to continue.

Such a move will be preceded by a short alert tone and the announcement by the PCO of the movement to a specified tactical talk group. PCOs will make every effort to monitor the activities of the special circumstances operating on a tactical talk group. At times, the staffing within the Communications center may not support dedicating a PCO to the tactical talk group. In such event, on-scene officers will be notified that the tactical talk group will not be monitored.



Administrative and Operational Manual

September 12, 2022

**4-101.5 RADIO USAGE-TALK GROUP ASSIGNMENTS**

The primary dispatch talk groups for daily law enforcement activities for the Charles County Sheriff's Office and Mutual Aid Agencies operating within Charles County will be assigned:

- "D1" for Districts One and Two
- "D3" for Districts Three and Four

All personnel operating on the Charles County Sheriff's Office home zone will monitor the primary dispatch talk group for the geographical district they are physically in. In the event an alternate talk group is required to facilitate uninterrupted communication to resolve an incident:

- "STAC1" shall be reserved for units operating within the "D1" talk group, and
- "STAC2" for units operating within the "D3" talk group.

All planned special operations or car-to-car communications that do not fall into daily law enforcement activities, will request through the PCO to use "STAC3", "STAC4" or the appropriate "SECOPS" talk groups to facilitate their communications needs without interruption to the primary dispatch talk group or their operation.

To accomplish the most efficient use of the tactical talk group, the on-scene officers will utilize the Incident Command System, by designating an Incident Commander. Usually the Incident Commander is the first arriving officer on the scene or the highest ranking officer. This officer will notify communications he is in command. If an on-scene Incident Commander is not identified, the PCO shall request that someone be named. The Incident Command system as contained in the Agency All Hazards Plan will be followed. The Incident Commander will provide direction and assign resources on the scene to manage the special circumstance. Unless delegating someone to act as communication officer, the Incident Commander is the direct point of contact between the scene and the Communications Section to provide updates on the progress of the incident or request additional resources to be dispatched. The Incident Commander may be replaced by a higher authority at that person's discretion. When this occurs, Communications will be immediately notified.

Once the special circumstance no longer requires a dedicated tactical talk group, the Incident Commander will notify Communications that the Incident Command is terminated. Communications will sound a short alert tone notifying involved officers to return to their assigned primary dispatch talk group and acknowledge their return to service.

**4-101.6 10-3 STOP TRANSMISSIONS**

A 10-3 should be used when there is an immediate officer safety need to suspend all radio transmissions on the primary dispatch talk group. During a 10-3, all officers shall cease normal activities, remain on the talk group, and listen for a call for help or other urgent transmissions, usually from a lone unit on the scene. For this reason, the 10-3 should be used only for the shortest period necessary to ensure the scene is safe. Every effort should be made to place a primary dispatch talk group in service as soon as practical. Once scene safety is secured, incidents that require prolonged uninterrupted communications shall be transferred to the appropriate tactical talk group for the affected district.

When a 10-3 is placed in effect by an officer or PCO, the PCO controlling the affected talk group will sound a short alert tone and announce the 10-3. The PCO will monitor the talk group for transmissions from the on-scene unit(s). If no transmissions are received within the first minute, the PCO will request the status of the unit. The 10-3 will remain in effect until such time as the on-scene units or supervisor place the talk group in service. Once the talk group is placed in service, the PCO will sound a short alert tone and announce the 10-3 has been lifted.



Administrative and Operational Manual

September 12, 2022

4-101.7 OFFICER IN DISTRESS (SIGNAL 13)

When a Signal 13 is received on any talk group, the PCO will immediately place a 10-3 on the channel and direct units to assist with the incident as appropriate, based on the information received during the distress call.

If the distress signal is received due to an officer activating their radio's emergency call button, users on that talk group will immediately cease all communications, allowing the officer to provide additional information. If the officer does not contact Communications to supply additional information in a timely manner, or the PCO cannot determine the nature of the emergency by the officer's original transmission, the PCO will check on the officer's status. The PCO will provide updates and instructions to other officers on the talk group as appropriate.

4-101.8 PHONETIC ALPHABET

To standardize radio transmissions in the spelling of words, the below terms shall be used in conjunction with their corresponding letters of the alphabet:

Table with 8 columns and 8 rows mapping letters A-Z to names: A ADAM, B BAKER, C CHARLES, D DAVID, E EDWARD, F FRANK, G GEORGE, H HENRY, I IDA, J JOHN, K KING, L LINCOLN, M MARY, N NORA, O OCEAN, P PAUL, Q QUEEN, R ROBERT, S SAM, T TOM, U UNION, V VICTOR, W WILLIAM, X X-RAY, Y YOUNG, M MARY, Z ZEBRA

4-101.9 RADIO CODE LIST

Table with 4 columns and 25 rows of radio codes and their meanings, such as 10-1 c Caution, 10-2 -- Unable copy-change location, 10-25 c Report in person (meet)....., 10-50 c Accident (F, PI, PD), 10-75 c in contact with.....

4-101.10 CLEARING CALLS- DISPOSITION

Whenever a dispatched unit clears a call, a clear and concise disposition shall be given. The PCO will enter that disposition on the call sheet. Should more information be required, the officers will use the MDT to enter notes. Officers should ensure that notes match the given disposition. If a report is to be written, Communications will advise the officer of the assigned incident number for the report. All calls will be cleared with a disposition for the



Administrative and Operational Manual

September 12, 2022

call sheet.

4-101.11 RADIO COMPLETION CODES

Situation Completion Codes	Report Completion Codes	Person Completion Codes	Vehicle Completion Codes
Unfounded UTL (Unable to Locate) GOA (Gone on Arrival) 2 GOA SOW (Sent on Way) Fled on Foot Handled by MSP Handled by Other Agency False Call Settled No One Home Civil Matter Checked OK Assisted Unable to Gain Entry Entry Gained Assignment Completed (10-24) Information Obtained Music Turned Down Notification Made Unable to Serve No Police Services Needed	No Report Report JOR (Juvenile Offense Report) Dom. Violence, Notice Given Dom. Violence, Notice/Report Supplement FIR (Field Information Report) Dom. Violence, Notice/Report/10-95 Property Recovered Use of Force Report Deer Tag Issued	10-95 10-95 With Report Emergency Commitment Voluntary Commitment Warrant Advised Warrant Executed/Served Civil Citation Alcohol Citation Summons Served Missing Person Located	Citation Warning Citation/Warning ERO (Equipment Repair Order) Citation/ERO Warning/ERO Entry Gained/Waiver Unable to Gain Entry Information Exchanged Vehicle Tagged Vehicle Removed/Towed Vehicle Removed/Seized No Damage/No Report

4-101.12 FALSE ALARM AND BUILDING COMPLETION CODES

**False Alarm** - This response is to be used by officers who arrive on the scene of an alarm. If homeowner is on scene, and advises accidental, it is a false alarm. If residence is checked and no signs of entry are observed, it is a false alarm. Hold-up alarms at T/A's that are accidental are false.

**Malfunctioning Alarm** - This response is used when an officer arrives on the scene and speaks with someone on the scene. That person must advise that there is a problem in the alarm system.

**Building Checked Secure** - This type of response is only to be used when an officer finds an open door or window and the subsequent search reveals no indication of crime.

4-101.13 REPORTING DISTRICTS

The reporting districts will be as follows:

- 01 La Plata
- 02 Indian Head
- 03 Waldorf (East)
- 04 Waldorf (West)
- 03 Calvert County (mutual aid)
- 03 Prince George's County (mutual aid)
- 01 Virginia (mutual aid)
- 01 St. Mary's County (mutual aid)

4-101.14 COVERAGE AREAS

The Coverage Areas for Charles County will be as follows:



Administrative and Operational Manual

September 12, 2022

EXAMPLE: 01A1

01 - District 1  
A - Sector A  
1 - Beat 1

## 4-102 CHARLES COUNTY SHERIFF'S OFFICE JURISDICTIONAL BOUNDARIES

The jurisdiction of the Charles County Sheriff's Office is Charles County, Maryland. This County is bounded on the North by Prince George's County, Maryland, and on the East by Calvert and St. Mary's County, Maryland. On the West by the water lines of the Potomac River and the Virginia Counties of Fairfax, Stafford, and Prince William. On the South by the Potomac water line of King George and Westmoreland Counties, Virginia. These boundaries are displayed graphically in the ADC of Alexandria, Inc. maps available from the Agency Quartermaster.

## 4-103 AGENCY TELEPHONE USAGE

This section of policy applies to the use of Agency land-line and wireless devices. Agency issued or personal, on- or off-duty, or while operating an Agency Vehicle. For the purposes of this policy, the term "wireless device" will include cell phones and all other devices issued or authorized by the Agency and shall include any communication device other than the Agency radio system or Mobile Data Terminal.

### 4-103.1 USE OF AGENCY LAND-LINE PHONES

A businesslike salutation will be made when answering telephones:

- All employees will identify themselves when answering telephones.
- Accepted salutation shall consist of:
  - the Agency name, "Charles County Sheriff's Office";
  - the division / section, or the location;
  - rank if sworn, or title if non-sworn;
  - alternately, civilian personnel may use their first and last names when answering.

Long-distance calls will not be made on an Agency-owned device when a less expensive procedure would suffice (e.g., mail, email, fax). When it is necessary to make a personal long-distance call, the Agency's system may be used, provided the telephone operator is contacted and the call is charged against the employee's home phone number. All personal phone calls received should be as brief as possible.

Generally, personal phone calls should not be made from Agency telephones. Personal phone calls received should be brief.

Prisoners, witnesses, suspects, etc., may use Agency phones for local calls, at the discretion of the custodial officer.

### 4-103.2 RESTRICTED USE OF CELL PHONES/WIRELESS DEVICES

When an employee is issued a cellular phone or other wireless device, they will be provided with the guidelines and limitations for its use. Employees should read and follow all directions provided within the owner's manual regarding the safe use of the wireless device.



Administrative and Operational Manual

September 12, 2022

Many employees are provided with wireless devices for the purpose of conducting Agency business. Use of these devices may incur additional air-time and access charges. Employees should determine which is most economical and efficient when deciding whether to use a wireless or land-line phone.

Employees issued Agency wireless devices may be responsible for additional costs associated with unauthorized use of the device, such as personal messaging or exceeding the allotted time limits, picture texting, roaming charges, etc.

Once the employee has been presented with an invoice for overages due on their Agency-issued wireless device, the employee will pay the invoice by the date due. If the payment is not submitted within one week after the due date, both the employee and his commander will be notified of pending service suspension. If payment has not been made by the second week after the due date, service will be suspended until the Accounting Section has received and processed the payment. The employee will be responsible for any reactivation fees incurred. Any roaming charges incurred using the Mobile Data Terminal or cell phone will be billed on a case-by-case basis. Payments must be made by check or money order payable to the Charles County Sheriff's Office (CCSO).

Electronic messages sent or received by Agency issued devices are considered property of the Sheriff's Office and are subject to monitoring or interception by the Agency. There will be no expectation of privacy concerning these messages when using an Agency-issued device.

Employees using cellular telephones / devices while driving a motor vehicle are obligated to follow the rules and regulations of the State of Maryland or any other federal, state, county or municipal law which imposes cell phone or wireless device use restrictions.

Under the Maryland Transportation Article, law enforcement personnel are exempted from restrictions on the use of handheld telephones when acting within the scope of official duties. Agency policy is that in all other circumstances, any employee using a handheld phone while operating an Agency owned vehicle, on- or off-duty, shall use a hands-free device or pull off the roadway in a safe location. Sworn officers acting within the scope of their official duties may use a handheld phone without a hands-free device or pulling off the roadway only when doing so does not pose an unreasonable risk to the safety of the officer and others.

Additionally, texting while operating an Agency/ personal vehicle is prohibited. According to Maryland Transportation § 21-1124.1 (b), an individual may not use a text messaging device to write, send, or read a text message or an electronic message while operating a motor vehicle in the travel portion of the roadway

The Agency shall not be responsible to the employee or any other party, either for payment of fines for a violation of a state's wireless device law, or claims arising out of a motor vehicle crash, which has been determined to be caused by a violation of the law.

Employees will not use any hands-free devices that are worn, such as Bluetooth earpieces, headsets, microphones, etc.

**At no time shall a cell phone or wireless device be used during a priority response or a pursuit.**

### 4-103.3 911 LINES

"911" lines are to be answered by saying "Charles County 911." "911" lines are for emergency calls only. If the call is not an emergency, the caller should be referred to the agency which can provide assistance. If possible, the agency's telephone number should be provided.

The "911" call taker is responsible for answering this line. If he is busy or on another line, the "911" line is to be answered by the following personnel in order:





Administrative and Operational Manual

September 12, 2022

- Fire / EMS Supervisor;
- Fire / EMS Dispatcher;
- CCSO Police Communications. (This line should be answered on the first ring.)

Minimum Information Needed:

- exact location (remember, a mailing address is not sufficient);
- nature of call;
- name of person calling and the name of their residence; and
- call back number.

Dependent upon the nature of the call, additional information should be obtained if appropriate:

- suspect identity and/or description;
- extent of injuries;
- whether or not weapons were involved and what type.

The majority of "911" callers will be highly distraught; some may be hysterical. The call taker should professionally, but firmly take control of the conversation, obtain the necessary information and advise the caller assistance is being dispatched.

#### 4-103.3.1 CCSO NON-EMERGENCY LINES - DISTRICT STATIONS

It shall be the responsibility of front desk personnel to answer these lines. If they are unable to answer, these lines are to be answered by Police Communications personnel at the La Plata District Station.

Employees assigned as call takers at the Indian Head and Waldorf District Stations will be responsible for answering the CCSO non-emergency lines at those locations. If it becomes necessary to leave the telephones unattended for a short period of time, and no one is immediately available to monitor them, front desk personnel at the La Plata District Station will be notified of the call taker's absence.

Whether answering non-emergency or "911" lines, employees will attempt to obtain sufficient information to facilitate an appropriate response. A caller's refusal to identify himself will not preclude an attempt to assist the individual nor inhibit a response by an officer to a call for service.

#### 4-103.3.2 DIRECT LINES

Listed below are the direct auto-dial lines located at the La Plata District Station and personnel, in order of responsibility, who answer them:

- MSP: Communications Personnel - Front Desk Personnel;
- DETENTION CENTER: Front Desk Personnel - Communications Personnel;
- WORK RELEASE CENTER: Front Desk Personnel- Communications Personnel;
- INDIAN HEAD DISTRICT STATION: Front Desk Personnel - Communications Personnel;
- WALDORF DISTRICT STATION: Front Desk Personnel - Communications Personnel;
- COURTHOUSE ELEVATOR: Front Desk Personnel - Communications Personnel;
- HOSPITAL: Communications Personnel - Front Desk Personnel;
- STATE AND COUNTY ROADS: Communications Personnel - Front Desk Personnel;
- SOUTHERN MARYLAND ELECTRIC: Communications Personnel - Front Desk Personnel.



**Administrative and Operational Manual**

**September 12, 2022**

#### **4-104 FACSIMILE UNIT (FAX MACHINE)**

The Office of the Sheriff currently has fax machines at several locations within the Agency.

For purposes of this Agency, the fax machine will be utilized for low-volume transmittals needed immediately, inclusive of incoming transmittals. Regular mail shall be used in lieu of the fax machine when copy is not needed immediately.

Document preparation - All documents, reports, transmittals, etc., to be sent shall be clearly marked **COPY** in bold across the face.

Telecopy cover letter - A telecopy cover letter shall be prepared by the requestor / operator, and preface the transmittal.

Authorized users - Employees assigned to the component of the Agency where the fax machine is located, and who are authorized by their respective commanders to do so, may operate the fax machines.

Authorized transmittals - Personnel requesting transmittals shall review the Agency AOM, Chapter 3, Sections 200 through 208 and 210 through 221, to ensure information, reports, etc., transmitted are not subject to confidentiality.

Responsibility to ensure the transmittal is not of a confidential nature shall be that of the Charles County Sheriff's Office requestor and not the fax machine user.

Associated outside Agency transmittal - From time to time associated outside agencies, e.g., State's Attorney's Office, will request a message to be sent via Agency fax machine. Any such requests will be satisfied in accordance with this policy and for legitimate law enforcement purposes only.

Restricted use of fax machines - Agency fax machines are for official use. Use of Agency fax machines for commercial or personal business transactions is prohibited.

Failure to comply with any part of this policy may result in disciplinary action.

#### **4-105 INCIDENT COMMAND AND COMMUNICATIONS (ICCV) VEHICLE**

The following sections establish procedures for the deployment and maintenance of the Charles County Sheriff's Office Incident Command and Communications Vehicle (ICCV).

The ICCV will be stored at a secure site established for this purpose. Communications Section will maintain a knowledge of the current storage location of this vehicle. The vehicle shall be available for use on a call-out basis, twenty-four hours a day.

Command responsibility for the ICCV is assigned to the Commander, Communications Section. The Commander shall create an SOP within the Communications SOP Manual as may be necessary to comply with the requirements of this section or to clarify any issues involving the maintenance or use of the ICCV. Any personnel assigned duties associated with the ICCV will be provided a copy of this SOP by the Commander, Communications. All such employees shall become familiar with these SOP.

##### **4-105.1 ICCV DEPLOYMENT**

The ICCV is used as a mobile staging / communications facility for the Charles County Sheriff's Office. The ICCV allows Agency personnel the flexibility to rapidly deploy a command, staging and communications facility to a variety of specialized situations including:



Administrative and Operational Manual

September 12, 2022

- parades, fairs and other special events;
- civil disturbances;
- barricade / hostage incidents;
- search and rescue operations;
- major crime scenes;
- natural and man-made disasters;
- warrant sweeps; and
- any other unusual occurrence.

Critical incidents or unusual occurrences will take precedence over all other assignments. Any supervisor may request the ICCV be deployed for an unusual occurrence. However, absent exigent circumstances, a command level officer must authorize the deployment. When deployed, the Incident Commander will be responsible for designating a safe location for the ICCV to be set up.

Only approved CCSO drivers will operate the ICCV any time it is deployed. ICCV drivers will receive training in the operation of all equipment contained in, or carried on the ICCV. Communications will maintain a list of all approved drivers to be used in call outs. The ICCV will not be utilized for any type of routine patrol activities, pursuits or traffic stops. The Commander, Communications, or if he is unavailable, the command officer in charge of the scene, will arrange for a relief driver if a continuous use is anticipated to, or in fact, exceed 10 hours.

#### 4-105.2 REQUESTS FOR DEPLOYMENT BY OTHER AGENCIES

The ICCV, upon approval of the Sheriff or, in exigent circumstances, of a command level officer, shall be made available to other governmental agencies for unusual occurrences. Other governmental agencies can include, but are not limited to:

- the Charles County Department of Emergency Services (per 3-160 MOU);
- the Charles County Fire and Rescue Incident Commander or the County Chief of Fire / Rescue Communications;
- the Maryland State Police;
- the Town of La Plata Police;
- other public safety agencies within the County; and
- other public safety agencies in surrounding jurisdictions.

#### 4-105.3 ICCV CARE AND MAINTENANCE

The Commander, Communications Section or his designee is responsible for scheduled maintenance and service of the vehicle. He will conduct monthly vehicle inspections, a monthly inventory, and will monthly test all equipment assigned to the ICCV. He shall complete, or cause to be completed, the Monthly Personnel & Vehicle Inspection Form #75 for the ICCV, each month.

In addition, when not deployed during any two-week time period, the Commander will cause the vehicle to be operated for at least 20 minutes and cause the conduct of a routine check of its equipment for operational readiness. In addition to completion of the monthly vehicle inspection sheets, a log will be maintained in the ICCV to record all inspections, inventories and maintenance.

Before and after each deployment, the designated driver will thoroughly inspect the ICCV inside and out for operational readiness, cleanliness and damages. The designated driver will be responsible for ensuring that the ICCV is properly set up and will assist other personnel in the proper use of the equipment.



Administrative and Operational Manual

September 12, 2022

After each deployment, the designated driver will ensure that the ICCV is fully fueled and returned in a clean orderly condition with all equipment intact and ready for use.

#### 4-106 REVERSE 911 - CITIZENS NOTIFICATION SYSTEM

Reverse 911 is a system used to call the home phones of the citizens of Charles County with important public safety information. The system utilizes multiple phone lines configured to manage the calling of numerous telephones in the most efficient way possible. Currently the Agency has four locations where a Reverse 911 request can be processed. They are:

- Communications (EOC);
- Agency ICCV;
- Commander, Communications Section (issued laptop); and
- Communications Coordinator (issued laptop).

Reverse 911 can be used for a wide range of notifications; however, to utilize the Verizon database associated with Reverse 911 there must be a defined public safety element. The Commander, Communications Section is responsible for the management and updating of the system. These responsibilities include the:

- development of administrative telephone databases;
- updating of the Verizon telephone database (weekly updates); and
- development of the internal system information, to include the:
  - data list;
  - geographical zones;
  - reporting information; and
  - configuration specifications.

#### 4-106.1 PROCEDURES FOR INITIATING A REVERSE 911 SESSION

Since the Reverse 911 is a tool used to assist in the quick dissemination of important and credible information to the public, use of the Reverse 911 system must be approved by a supervisor. All requests must come from someone with supervisory authority. The request should include the following information:

- a reason for the use of Reverse 911;
- the message to be disseminated with a return call number if needed;
- a location / area to receive the message call; and
- the time frame the calls should be made.

The above information shall be sent via email to [reverse911@ccso.us](mailto:reverse911@ccso.us). The information will then be reviewed by Media Relations and edited for dissemination. Once the session has ended, a report will be generated and sent to the requester for their file.

The system is currently designed to call about 1000 telephone lines per hour. The system will make calls between the hours of 0830 to 2000. If a different time frame is needed, this will be listed in the requester's email.

#### 4-106.2 TIME CRITICAL SESSIONS

Reverse 911 sessions that require a rapid initiation will be routed directly to a representative with the ability to create a session. The requester will simply state in the email to [reverse911@ccso.us](mailto:reverse911@ccso.us) that the session is time sensitive



**Administrative and Operational Manual**

**September 12, 2022**

based on the information being sent out and the nature of the underlying event. When a time sensitive request is made, the session and session message may be created without going through Media Relations.

In order that a confirmation of the receipt of these time critical notifications be received, a follow-up call will be made to the on-duty Communications supervisor. The Communications supervisor will see that the time critical session is initiated.

#### **4-107 AGENCY NOTIFICATION SERVICE**

The Agency has developed a notification service that allows police station technicians and Police Communications Officers to send out notifications and/or alerts to the entire Agency via the CAD (Computer Aided Dispatch). These notifications / alerts can be received through the Agency email or by text message to a cell phone upon request.

Employees are automatically entered into a specific page group (Entire Agency, Sworn, Corrections), and any employee wishing to change the method by which they are notified should contact the Commander, Communications Section.

These notifications / alerts would be used only for emergencies or short notices, such as total radio system failure, Agency Operational Status, road hazards (ice / construction) and bridge closures for employees traveling to and from work.

All requests for notifications will be sent out by police station technicians and PCOs as directed by the Commander, Communications Section. The notification service is administered and maintained by the Communications Commander or his designee.

#### **4-109 SILENT ALARM RESPONSE**

##### **4-109.1 OFFICER RESPONSE**

Until determined otherwise, all commercial holdup alarms will be treated as if the suspect(s) are still on the scene and a crime is in progress. The actions of all officers involved will be geared to the safety of all persons involved and the prevention of a hostage situation.

A minimum of two officers will be dispatched and respond to the call. Officers will incorporate varying response tactics based on:

- distance from the location;
- traffic; and
- tactical / covert avenues of approach.

The first officer to arrive on the scene will assume scene command and direct additional responding officers to take tactical positioning or rove the area. This officer will also determine the need for the use of an alternate talk group (tactical channel) for Communications. Each officer arriving on the scene will advise the officer in charge of their location relevant to the scene through Communications. Plain clothes officers will advise a brief description of their clothing.

Once the scene is secured, Communications will direct an employee of the business or a resident to meet with officers on the scene. The employee or resident will confirm with the officer either a crime has occurred or the alarm was false.

Officers will utilize instant circumstances to determine what type of approach is needed. These circumstances may include information from a telephone contact made by Communications if one was made. The officer in charge



Administrative and Operational Manual

September 12, 2022

---

should consider:

- number of officers needed to accomplish a safe approach;
- resources available;
- type of structure and occupants;
- cover and concealment

Should it be determined a crime is in progress, the officer in charge will establish a tactical perimeter to prevent escape. The officer in charge will take precautions to prevent alerting the perpetrators to the presence of the police.

If the suspect(s) have left the scene, the officer in charge will obtain descriptions and last direction of travel, then broadcast the information to Communications.

False alarms will be confirmed by an officer and a County Government False Alarm Notification form will be issued to the business or resident.

#### **4-109.2 COMMUNICATIONS' RESPONSIBILITIES**

Upon receiving a call for a commercial holdup alarm, dispatchers will simulcast an emergency alert tone and assign a minimum of two (2) officers to respond to the call priority. Dispatchers will immediately attempt to contact the business and develop information concerning the nature of the situation.

Any information obtained concerning a crime in progress or one that just occurred will be dispatched to responding officers as soon as possible to include:

- suspect descriptions;
- vehicle descriptions; and
- direction of travel.

If it can be safely determined the alarm is accidental, or malfunctioning through initial contact or the alarm company, dispatchers will alert the responding officers and reduce the priority response.

Calls for a holdup or burglary in progress received from a victim business or third party by telephone and not an alarm company will be handled by Communications in the same manner.



Administrative and Operational Manual

September 12, 2022

## **4-110 INTERPRETERS / TRANSLATORS SERVICES**

The International Visitors Information Service (IVIS) provides a 24-hour translation service for forty-nine foreign languages.

The Southern Maryland Interpreting Service provides 24-hour on-call American Sign Language interpreting services for the deaf and hard-of-hearing community.

Contact telephone numbers for both are maintained by Communications and may also be accessed via the CAD System Rolodex function.

### **4-110.1 BILINGUAL EMPLOYEES**

In addition to the above, the Agency employs several members who, when available, may be able to provide some translation services. Requests for such services will be made through the on-duty district / shift commander.

### **4-110.2 DEAF / HARD-OF-HEARING INDIVIDUALS**

A deaf or hard-of-hearing person will usually indicate deafness or a hearing disability by pointing to their ears and then their mouth (the sign for “deaf”). They may point to their ear and shake their head, indicating they cannot hear. If in a vehicle, an individual may display a visor card that indicates the driver is deaf.

Some characteristics associated with communications disabilities may be misinterpreted by police as suspicious, illegal or uncooperative behavior. Upon contact they may reach into a pocket, glove compartment, or elsewhere to obtain a pen and paper. When a person who is deaf or hard of hearing fails to respond to police direction, it is often a manifestation of the disability rather than an intent to disobey. Officers, while ensuring their own safety, must be careful not to misinterpret these actions.

People who have communications disabilities are entitled to the same range of police services as those who do not have disabilities. It is the intent of the Charles County Sheriff's Office to provide a qualified interpreter, upon request, to any person who is deaf or hard of hearing, regardless of whether they are a suspect, victim, witness or complainant.

It is the policy of the Charles County Sheriff's Office to furnish, at Agency expense, appropriate auxiliary aids and services whenever necessary to ensure effective communication with individuals who are deaf or hard of hearing.

Auxiliary aids and services include qualified interpreters, written materials, note pads, and other effective methods of making aurally delivered materials available to individuals who are deaf or hard of hearing. When an auxiliary aid or service is required to ensure effective communication, the expressed choice of the individual with the disability, who is in the best position to know his or her needs, should be given primary consideration in determining which communication aid to provide. The Agency should honor the individual's choice unless it can show another equally effective means of communication is available, that use of the means chosen would result in a fundamental alteration in the services or programs provided, or that it would cause undue financial and administrative burdens.

In those instances where there is the likelihood of a particular case going to trial, all written questions and responses between the person with a hearing disability and police must be treated as evidence and handled accordingly. A copy of any written questions and responses shall be provided to the deaf or hard-of-hearing person.



Administrative and Operational Manual

September 12, 2022

### 4-110.3 SIGN LANGUAGE INTERPRETERS

Officers are required to ensure effective communication with individuals who are deaf or hard of hearing. Whether a qualified sign language interpreter or other communication aid is required will depend on the nature of the communication and the needs of the individual. The length, importance or complexity of the communication will determine whether an interpreter is necessary for effective communication.

In some cases a deaf individual may utilize a pen and paper to communicate, rely on lip reading or rely on friends or family members to interpret for them. Officers should consider the overall circumstances when making a decision on how best to proceed. Officers need to be aware that lip reading is not a very effective way to communicate and should take into consideration that using a friend or family member who is a juvenile, may not be the most reliable way to communicate and should be used only in exigent circumstances.

Officers must be careful about miscommunication in the absence of a qualified interpreter; a nod of the head may be an attempt to appear cooperative in the midst of misunderstanding, rather than a consent to a confession of wrongdoing. While each case may be different, the following guidelines for determining the need for an interpreter may be helpful:

- in a simple encounter, such as checking a driver's license or giving street directions, a pen and notepad may be sufficient;
- if an individual without a hearing disability would be subject to police action without interrogation, then an interpreter may not be required; however, if an interpreter is requested or the officer does not believe other means of communication are effective, then a qualified interpreter should be provided;
- during arrests and interrogations or interviews with victims, witnesses or complainants, a sign language interpreter will often be necessary to effectively communicate with an individual who uses sign language;
- if the legality of a conversation may be questioned in court, such as when Miranda rights are given to a suspect, a sign language interpreter should be utilized.

When utilizing the services of a sign language interpreter, officers should speak directly to the deaf person. Officers should be aware that interpreters are legally bound to interpret everything said in their presence, so officers should refrain from saying anything they would not want conveyed to the deaf individual.

When an interpreter is used, officers shall fully document in the case report the reason an interpreter was necessary, the interpreter's identifying information and their time spent interpreting.





Administrative and Operational Manual

September 12, 2022

---

## 4-111 EMERGENCY RESPONSE CLASSIFICATIONS AND GUIDELINES

Officers are granted special privileges under Maryland State law while operating their vehicles with their emergency equipment activated. They are not, however, relieved of the responsibility of driving with due regard for the safety of all persons, and are not protected from the consequences of failing to exercise reasonable care under these circumstances.

There is no special privilege for operating an emergency vehicle without the emergency equipment activated. Operators of emergency vehicles without the emergency equipment activated are held to the same level of care as every other vehicle driver.

Police emergency vehicle driving is a dangerous activity. The emergency operation of a police vehicle is dangerous to both the police officer and the general public. Although quick police response to an emergency is crucial, the most important factor in police emergency response is to arrive safely.

The driver of an emergency vehicle, with emergency lights and siren activated, may proceed through a red or stop signal, a stop sign, or a yield sign, but only after slowing to a speed which will ensure they can safely enter and navigate through the intersection.

Officers operating a vehicle containing a passenger who is not an employee of a law enforcement agency, or a person who has not executed a waiver absolving the Office of the Sheriff of liability for damages or injury, shall not operate their vehicle as an emergency vehicle in any high speed manner. Exceptions to this policy required by extreme circumstances require written explanation of those circumstances.

### 4-111.1 RESPONSE CLASSIFICATIONS

**Routine Response** - All non-emergency calls for service. Members responding to non-emergency calls will respond immediately while observing all traffic laws.

**Priority Response** - All emergency calls for service. Members responding priority shall use lights, siren, and headlights.

Members shall also comply with the provisions of the Transportation Article (TR § 21-106), Emergency Vehicles. The driver of an emergency vehicle may:

- park or stand without regard to the other provisions of this title;
- pass a red or stop signal, a stop sign, or a yield sign, but only after slowing down as necessary for safety;
- exceed any maximum speed limit, but only so long as the driver does not endanger life or property;
- disregard any traffic control device or regulation governing direction of movement or turning in a specified direction.

The emergency vehicle operator shall be aware that this section does not relieve the driver of an emergency vehicle from the duty to drive with due regard for the safety of all persons.

Agency policy requires that members responding priority response shall approach all intersections where their direction of movement is controlled by a stop signal or stop sign with due regard to public safety. Vehicle operators may proceed through a controlled intersection only when such movement can be made safely.

Units involved in a priority response will not pass each other, or other emergency vehicles (fire trucks, rescue squads, EMS units, etc.) except for some specific planned purpose. Each unit involved in the pass should be



Administrative and Operational Manual

September 12, 2022

aware of the other's intentions and the pass should be coordinated verbally over the radio.

**NOTE:** This section does not prevent or preclude a pass required because of safety requirements necessitated by unexpected movements of any vehicle.

#### 4-111.2 GENERAL RESPONSE ASSIGNMENT GUIDELINES

Personnel receiving calls for service will make every effort to obtain all available information concerning the call, based on the conversation with the complainant. If the call taker has any doubt concerning the nature of the incident, the doubt will be resolved in favor of the higher priority.

PCOs, PCSs, and patrol officers, with the approval of a Patrol Supervisor or higher ranking Agency officer, have the ability to change a call's priority code. The person changing a call's priority should have knowledge which indicates such change is needed. The responsibility for consequences of this decision rests with the Patrol Supervisor or other Agency officer making the decision. All patrol units will ensure that Communications is aware of their response status at all times. They will notify Communications of any changes in response status.

##### 4-111.2.1 INOPERABLE EMERGENCY EQUIPMENT

Marked patrol vehicles shall be immediately removed from service if the overhead light bar is out of service. Any vehicle without a working siren shall be immediately removed from service. Any officer with a malfunctioning light bar or siren (marked or unmarked vehicle) shall notify their supervisor as soon as they become aware of the deficiency.

#### 4-111.3 GENERAL DISPATCH GUIDELINES FOR PRIORITY RESPONSE INCIDENTS

Priority responses shall be limited to those calls dispatched as emergency calls, unless information is known to the PCO or responding officer which would justify changing the response classification.

Primary units are defined as those units assigned to the call. Primary units may be directed by the PCO to respond to the scene PRIORITY. All other response units are back-up or support units and will respond routine unless specifically directed otherwise. The PCO will determine whether to assign one or two primary units based on available information.

The first unit to arrive on an incident scene will immediately notify the PCO if a change in response classification or additional units are necessary. If appropriate, the PCO will then specify which units will respond and the nature of their response.

When an on-scene unit advises that other units may terminate (10-22) their response, those units shall not respond to the scene but will return to service.

##### 4-111.3.1 SELF INITIATED PRIORITY RESPONSES

Officers may initiate a priority response or pursuit in order to:

- protect life;
- prevent the occurrence of personal injury;
- prevent the commission of a crime; and
- prevent the escape of any law violator.

(Refer to guidelines under the Pursuit Policy for further information about responsibilities.)



Administrative and Operational Manual

September 12, 2022

[Redacted text]

- [Redacted list item]
- [Redacted list item]
- [Redacted list item]
- [Redacted list item]

[Redacted text]

<ul style="list-style-type: none"><li>[Redacted list item]</li><li>[Redacted list item]</li><li>[Redacted list item]</li><li>[Redacted list item]</li><li>[Redacted list item]</li><li>[Redacted list item]</li><li>[Redacted list item]</li><li>[Redacted list item]</li><li>[Redacted list item]</li><li>[Redacted list item]</li><li>[Redacted list item]</li><li>[Redacted list item]</li><li>[Redacted list item]</li><li>[Redacted list item]</li></ul>	<ul style="list-style-type: none"><li>[Redacted list item]</li><li>[Redacted list item]</li><li>[Redacted list item]</li><li>[Redacted list item]</li><li>[Redacted list item]</li><li>[Redacted list item]</li><li>[Redacted list item]</li><li>[Redacted list item]</li><li>[Redacted list item]</li><li>[Redacted list item]</li><li>[Redacted list item]</li><li>[Redacted list item]</li><li>[Redacted list item]</li><li>[Redacted list item]</li></ul>
---	---

[Redacted text]

[Redacted text]

[Redacted text]

[Redacted text]

[Redacted text]

- [Redacted list item]
- [Redacted list item]
- [Redacted list item]
- [Redacted list item]
- [Redacted list item]

[Redacted text]



Administrative and Operational Manual

September 12, 2022

[REDACTED]

[REDACTED]

[REDACTED]

[REDACTED]

#### 4-111.5 NEXT-OF-KIN NOTIFICATIONS

Members of the Charles County Sheriff's Office will make next-of-kin notifications in a prompt and considerate manner. The traumatic injury or loss of a loved one is a traumatic experience. Notifications in these instances will be conducted in a sensitive and compassionate manner. All such notifications in the County shall, unless circumstances prevent it, be made in person.

It shall be the responsibility of the primary investigating officer to ensure notifications are made without undue delay. Prior to making the notification the officer will verify that all information is correct. In most cases, notification will be made to the next-of-kin prior to releasing information to the media or any other person or entity.

Officers may request assistance from a member of the Chaplain Services, Victim Services, a close friend or family member, or other appropriate person in making the notification.

In instances where the next-of-kin resides in an area that makes direct notification by an officer of this Agency impractical, a message requesting notification be made will be sent to the law enforcement agency having jurisdiction where the next-of-kin resides. Confirmation of the notification should be obtained from the agency having jurisdiction.

When a request is received from another law enforcement agency or other responsible authority to deliver an emergency notification to a next-of-kin within Charles County, every possible attempt will be made to cooperate with the requesting agency. The officer assigned to make such notification shall advise the Communications Section of the outcome. If requested, Communications will make a return call to the requesting agency.

[REDACTED]

[REDACTED]

[REDACTED]

[REDACTED]



Administrative and Operational Manual

September 12, 2022

[REDACTED]

[REDACTED]

[REDACTED]

[REDACTED]

[REDACTED]

[REDACTED]

[REDACTED]

[REDACTED]

[REDACTED]

[REDACTED]

[REDACTED]

[REDACTED]

[REDACTED]



Administrative and Operational Manual

September 12, 2022

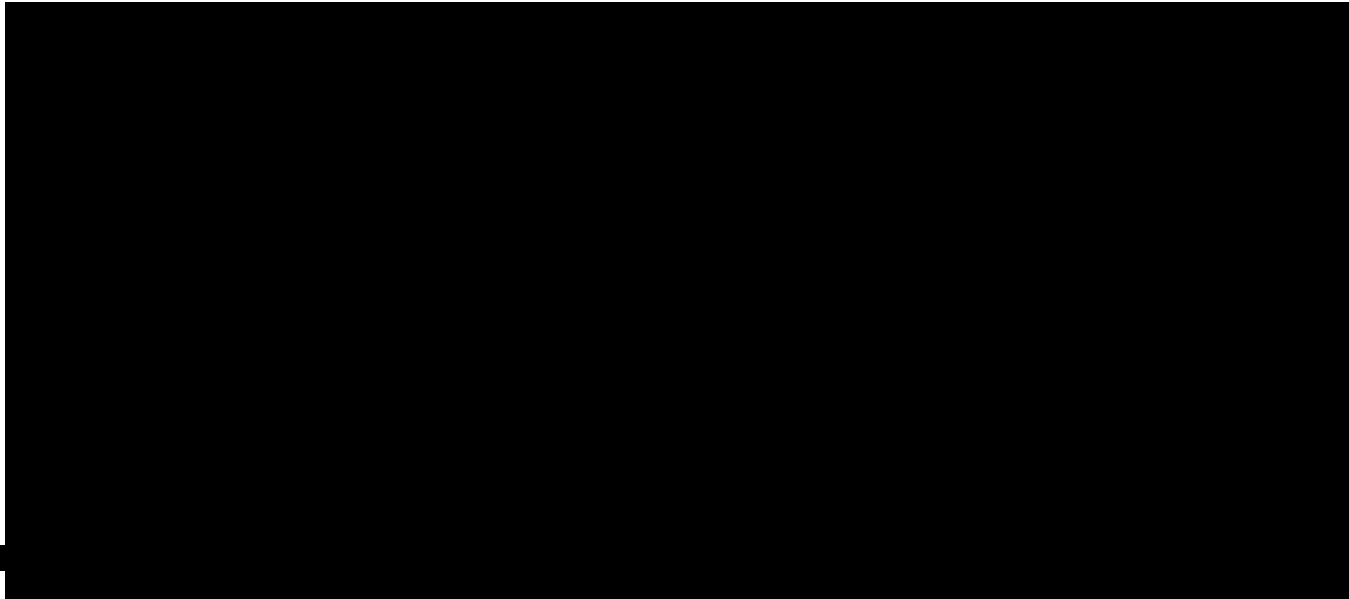

- [Redacted]
- [Redacted]
- [Redacted]
- [Redacted]



**4-112 FALSE ALARM ORDINANCE**

In an effort to reduce the number of responses to false alarms, the False Alarm Ordinance Number 98-48 was adopted by the County. The ordinance requires the police to assist the Charles County False Alarm Reduction Unit (FARU) by notifying the FARU of any alarms that are false or malfunctioning. This is accomplished through the computer aided dispatch system (CAD) and through the use of the False Alarm Notification Form. Procedures have been established to ensure standardized completion of this form.

**4-112.1 NOTIFICATION FORMS**



Administrative and Operational Manual

September 12, 2022

All officers will carry the False Alarm Notification Form in their Agency vehicles. The forms will be distributed through the Quartermaster and available at all district stations.

### 4-112.2 RESPONSE TO ALARMS

The response to all alarms should be as per the guidelines in the AOM. Once an alarm is determined to be false, the False Alarm Notification Form will be completed. The form will be completed for residential, commercial and governmental building false alarms to include false panic / intrusion and hold-up alarms.

Response to and issuance of forms at repeat alarms, not weather related, shall be at the discretion of the on-duty supervisor. Generally, if someone in charge of the building is on the scene or responds to the alarm and attempts to correct the problem, only one form will be issued.

### 4-112.3 COMPLETION OF THE FALSE ALARM NOTIFICATION FORM

The alarm, if false, will be coded in one of two ways. In order to ensure accuracy and fairness in the administration of the false alarm ordinance, it is important that each alarm be cleared with the appropriate code. The following codes will be used:

- FA - (False Alarm) will be used when there is no evidence of a criminal or attempted criminal offense. This code is also to be used when the alarm is the result of alarm user error, the alarm user not having the proper clearance code, or when unable to determine the cause of the alarm activation from either the alarm user or the alarm company.
- MA - (Malfunctioning Alarm) will be used if there is specific evidence which indicates defective or malfunctioning alarm equipment.

Once a determination has been made concerning the cause of the alarm, the False Alarm Notification Form will be completed. The form is to be filled out as follows:

- Line 1 - Name and/or address of the business or residence where the violation occurred in this order of preference:
  - business or residence owner or tenant; or
  - an officer of the corporation that owns the building; or
  - person in charge of the business location at the time of the alarm; or
  - street address if location is unoccupied at time of the alarm.
- Line 2 - Agency name--Charles County Sheriff's Office.
- Line 3 - Officer's name / ID, district where alarm occurred, and check the box marked police.
- Line 4 - Date and time; alarm permit number is left blank.
- Line 5 - Situation Found--check appropriate box.
- Line 6 - Weather Conditions--check appropriate box.
- Line 7 - Other--check appropriate box (what caused alarm).
- Line 8 - Completion Code--check appropriate box.
- Line 9 - Comments--any additional information for the FARU the officer determines relevant.
- Line 10 - This line is not on the current form, but is needed to record the event number for tracking purposes. Place the event number in the lower right corner of the form.

After completion of the form at the scene, copies will be distributed as follows:



**Administrative and Operational Manual**

**September 12, 2022**

---

- White Copy - CCSO Records Management Section
- Pink Copy - CCSO Records Management Section
- Cream Copy - Left at the alarm location

The False Alarm Notification Form is a door hanger type form. The copy left at the alarm location will be left with the individual responsible for the alarm location. If no one is present at the alarm location, the form is to be left so it may be found at an entrance to the building or residence.

#### **4-112.4 WEATHER**

Weather sometimes plays a part in the response to alarms. Major weather incidents, such as heavy rain, wind, lightning, and thunderstorms can cause alarms to activate. During weather incidents such as these, the False Alarm Notification Form will be completed; however, during any one shift it will be completed only once at repeat alarm locations.

#### **4-112.5 CONTACT WITH RESIDENT OR EMPLOYEE**

Responding officers are cautioned that if an employee or resident is available at the alarm site and there is no evidence to support the alarm activation, they must be extremely careful not to speculate as to the cause of the alarm or to make any references to the alarm possibly not being false. Officers must be cautious about making any comments that might leave the impression that the alarm will be cleared as a legitimate alarm call. Unless there is evidence to support such a premise, officers must not make generalized statements such as "someone may have tried to get in." Comments made could later be used by the alarm user to attempt to justify an appeal.

#### **4-112.6 FINAL DISPOSITION OF FORMS**

Upon completion of the form, the white copy and the pink copy will be forwarded to the Records Management Section, where the pink copy will be kept on file and the white copy will be sent to the FARU.

In addition, when an officer responds for a false alarm at any Agency facility or co-use facility (Courthouse, Quartermaster's office, etc.) Records Management shall forward a copy of the form to the Commander, Property Management.





Administrative and Operational Manual

September 12, 2022

---

## 4-113 NOISE CONTROL ORDINANCE ENFORCEMENT

Chapter 260 of the Charles County Code provides for the control of noise levels throughout Charles County so as to promote public health, safety, and welfare of both public and private property. The Code states:

“It is prohibited for any person located within the County to make any noise or operate any sound amplifier on any property owned or occupied by such person, or to permit any noise to be made or any sound amplifier to be operated on property owned or occupied by such person, so as to be clearly audible to any person located beyond the property line of such property at a level higher than those set forth.”

Responsibility for the enforcement of the noise control ordinance is shared per an MOU between the Office of the Sheriff and the Charles County Department of Health. The Health Department will respond during regular business hours to noise complaints. The Sheriff's Office is responsible for the investigation and enforcement of noise complaints between the hours of 1700 and 0800 Monday through Friday and on weekends and state / federal holidays. However, there may be times when it may be necessary for both the Health Department and the Sheriff's Office to respond to a noise complaint.

For the purposes of this policy, the Director of Environmental Health shall be the point of contact with the Health Department, and the Patrol operations commanders will be the point of contact for the Sheriff's Office.

Investigation and enforcement will be per procedures outlined in this policy and as instructed in training. Officers will use only Agency issued and calibrated sound level meters to measure possible violations of Charles County Code, Section 260 - Noise Control.

### 4-113.1 DEFINITIONS

In this section, the following terms have the meanings indicated.

**Noise Complaint** - Any incident where noise is generated by an audio device, vibration, musical instrument, mechanical equipment, or any other noise or sound-producing device that disturbs, injures, or endangers the health, peace and safety of others.

**Ambient Noise** - The total noise associated with a given environment, excluding the noise source of interest.

**Commercial Land Use** -- Property zoned or used for the sale of goods or services or for office uses.

**Tonal Noise** - Any sound comprised of one or more pure tones. A pure tone means any sound that can be distinctly heard as a single pitch.

**Impulsive Noise** - Noise characterized by a short burst of acoustical energy, having a rapid rise to a maximum pressure followed by somewhat slower decay, a duration not greater than one second, and a field crest factor of 10dBA or greater. An example of impulsive noise would be weapons fire.

**Daytime** – Between 7:00 a.m. and 10:00 p.m., local time.

**Decibel (dB)** - A unit of measure equal to 10 times the logarithm to the base ten of the ratio of a particular sound pressure squared to a standard reference pressure squared. For the purpose of this chapter, 20 micropascals shall be the standard reference pressure.



Administrative and Operational Manual

September 12, 2022

**Department** - The Charles County Health Department.

**Director** – The Director of Environmental Health.

**Enforcement Officer** for a noise originating from any source:

- An employee or agent of the Department designated by the Director to enforce this chapter;
- A law enforcement officer;
- A person authorized under the Zoning Ordinance to enforce this chapter; or
- A person authorized by the County to enforce this chapter.

**Enforcement Officer** for a noise originating from an animal source:

- The Chief of the Division of Animal Control Services or the Chief's authorized designee.

**Nighttime** - Between 10:00 p.m. and 7:00 a.m., local time.

**Person** - Any individual, group, firm, association, agency or other entity.

**Public Property** - Any real property or structures thereon that are owned, leased, or controlled by a governmental entity, including any street, avenue, boulevard, road, highway, sidewalk, alley or easement that is owned, leased, or controlled by a governmental entity.

**Residential Land Use** - Property zoned or used for dwellings.

## 4-113.2 TRAINING, CERTIFICATION, AND MAINTENANCE

Only those officers who have completed approved Agency training and possess current certification are permitted to use sound level meters for enforcement purposes. The Patrol Commander will ensure maintenance of a current file of all those officers who have successfully completed the training and have been certified.

The Patrol Commander or designee will ensure that:

- Sound level meters are available to certified operators.
- Sound level meters are calibrated every two years by an accredited laboratory. This is in addition to the bi-monthly calibrations performed in-house.
- All necessary care and maintenance is performed.
- An inventory log and calibration log are maintained by the designated Noise Ordinance Coordinator.

Officers using sound level meters will conduct calibration and testing with available equipment in a manner commensurate with the training received. The use of any sound level meter that is not properly calibrated, or is not approved, or otherwise does not function as required is strictly prohibited. Monitoring of noise levels for enforcement purposes will be done in accordance with the training received and all applicable laws.

The operator will forward all requests for repair and maintenance of noise meters to the Patrol Commander. Reports of damage to noise meters will be documented the same as with other Agency owned property.



Administrative and Operational Manual

September 12, 2022

**4-113.3 INVESTIGATION AND ENFORCEMENT**

Any officer dispatched to an initial noise complaint will respond and make contact with the complainant to determine the source of the noise. If the source of the noise is located, and does not qualify as an exempted source as set forth in the County Code, a trained and certified officer will take a sound level meter measurement of the noise source.

The measurement of noise levels shall be conducted as instructed in training. If it is determined that the decibel measurement exceeds established thresholds and a violation does exist, the violator will be contacted and warned to cease the noise generating activity immediately.

If the violator responds and corrects the situation, no further enforcement action will be taken. The officer will advise the complainant the violator has been warned and if the noise persists, to contact the Sheriff's Office and a follow up investigation will occur.

If a complainant reports the violation continues, an officer trained and certified in the use of noise measuring instruments will respond to the location and complete an analysis of the noise. If the noise measurement determines the violation is in excess of the established noise level, a Civil Citation Form #DC-28 should be issued. When a Citation is issued, the violator shall be subject to a fine of up to \$500.00 for a first violation and up to \$1,000 for each subsequent violation. Each hour during which a violation continues to exist shall constitute a separate and additional violation.

The measurement will be conducted at least three feet from any reflecting surface. Sound level readings should not be conducted in adverse weather conditions. The Officer shall account for ambient noise (noise existing without noise source in question) if possible.

**4-113.4 NOISE EXCEEDING MEASURABLE STANDARDS**

Per County Code, Chapter 260, it is prohibited for any person located within the County to make any noise or operate any sound amplifier on any property owned or occupied by such person, or to permit any noise to be made or any sound amplifier to be operated on property owned or occupied by such person, so as to be clearly audible to any person located beyond the property line of such property at a level higher than those set forth in this section, as such sound may be measured from: a) any point along the front line of the property or any part of the perimeter property line upon which the noise is being made or generated; or b) any place on adjacent property, provided that the person measuring the sound shall first obtain the permission of the adjacent property owner to enter upon said property. The noise prohibited in this section shall include noise exceeding the following standards:

**Maximum Allowable Noise Levels (dBA)**

**Measured at Receiving Land Uses**

<u>Land Use of Receiving Property</u>	<u>Maximum Decibel Level</u>
<b>Industrial</b>	75 dBA, daytime or nighttime
<b>Commercial</b>	67 dBA, daytime 62 dBA, nighttime
<b>Residential</b>	60 dBA, daytime 50 dBA, nighttime

**Construction noise limits.** A person may not cause or permit noise levels emanating from construction or



Administrative and Operational Manual

September 12, 2022

demolition site activities which exceed:

- 90 dBA from 7:00 a.m. to 10:00 p.m., weekdays;
- The levels specified in this policy for nighttime hours at any other time.

#### 4-113.5 EXEMPTIONS

The County Code provides for the following exemptions:

- Household tools and portable appliances, when used for household maintenance during daytime hours and when maintained in accordance with manufacturer's specifications.
- Motor vehicles licensed for use on public roads when used in a manner consistent with the Transportation Article of the Annotated Code of Maryland.
- Aircraft and related operations at airports licensed by the Maryland State Aviation Administration.
- Boats and motorized land vehicles, both on- and off-road, in operation on public lands under the jurisdiction of the Department of Natural Resources or the County, or operated by other law enforcement or emergency services personnel.
- Emergency operations, including, but not limited to, snow removal operations.
- Pile-driving equipment during the hours of 7:00 a.m. to 5:00 p.m.
- Trap shooting, skeet shooting, or other target shooting between the hours of dawn and dusk.
- Trash collection operations between the hours of 7:00 a.m. and 10:00 p.m.
- Construction and repair work on public property.
- Noise emanating from household pet activity when kept in a manner consistent with the Zoning Chapter and when activities are in compliance with any applicable section of the Charles County Code. Noise complaints involving household pet activity shall be resolved under the Charles County Animal Regulations, Chapter 230 of the Charles County Code.
- Activities or events conducted or sponsored by the County or other government entity, including without limitation, agencies working in conjunction with Charles County Animal Control Services, concerts, the 4th of July parade and fireworks, and the like.
- Sound equipment used by public service companies as defined in Article 78 of the Annotated Code of Maryland, or to federal, state or local governmental agencies.
- Sound generated by sporting, amusement, and entertainment events and other public gatherings operating according to terms and conditions of the appropriate local jurisdictional body. This includes, but is not limited to, athletic contests, amusement parks, carnivals, fairgrounds, sanctioned auto racing facilities, parades, and public celebrations. This exemption only applies between the hours of 7:00 a.m. and 12:00 midnight.



Administrative and Operational Manual

September 12, 2022

- 
- Chapter 260 of the County Code shall not apply to the erection (including excavation), demolition, alteration or repair of any building or structure where it is necessary for public health and safety to allow such activity, and then only with prior written permission from the Department of Planning and Growth Management.

Nothing in Chapter 260 of the County Code shall be construed as to supersede or abridge any right granted pursuant to Chapter 100 of the Charles County Code, Right to Farm.

## 4-113.6 DOCUMENTATION

The Form #DC-28 is used for adult civil violations, also known as code violations.

### **CHARLES COUNTY CODE - Chapter 260, Noise Control**

Civil Code violations are not criminal violations and do not call for a physical arrest. In addition to other required information, the back of the officer's copy of the citation shall include: meter serial number, date of last calibration, time start / finish, and description of the noise source. The back of the original copy (white) should be used for recording any witness information.

Failure of the defendant to sign the citation does not subject him / her to arrest. "Refused to Sign" shall be written in the defendant's signature block and the citation issued.

Per the MOU with the Department of Health, the Charles County Sheriff's Office Patrol Operations will provide monthly reports to the Health Department indicating:

- The number of responses to noise complaints.
- The date, time and location of the complaint.
- The complainant and contact information.
- Observations at the scene.
- Any actions taken.



## Administrative and Operational Manual

September 12, 2022

## 4-115 COMMAND INFORMATION

In order to provide for effective operation and management of the Agency, command and other designated personnel must have access to timely information. In addition to the formal written command notification requirements of this section, when the nature of the incident has a time sensitive or critical element, notification shall be made in the most expeditious manner available. This will normally be accomplished by telephone or cell phone, but may be done face to face if this is required by instant circumstances.

Such notifications will be made to at least the Sheriff, Assistant Sheriffs, and the immediately affected division and section commander(s). The employee in charge of the incident shall be responsible for ensuring notifications are made. If the responsible employee is unable to make the notifications personally due to ongoing responsibilities of managing the incident, he may require that Communications or other personnel make the notifications. The required non-written notifications shall be accomplished as soon as possible.

When notifications are made by Communications personnel, a note of the date, time and method of notification for each person notified will be entered into the call log information. When notification is made by the employee responsible for managing the event, this information will be noted on the written Commanders' Information Report.

Notifications generally fall within two distinct groups. The first is that of criminal activity, and the second is all other information reportable under this policy. For the purpose of referral, the first is titled Crime Information Report, and the second, Commanders' Information Report. Each of these is distributed to a different list of recipients and has different levels of sensitivity associated with it.

### 4-115.1 INITIAL NOTIFICATION AND OVERVIEW "CRIME REPORTS"

These reports are in addition to any reports required by other Agency policy. They are designed to provide listed personnel with a quick, initial overview of criminal activities which come to the attention of the CCSO. Crimes which are to be the subject of Crime Information Reports are major crimes, for example:

- Bomb threats
- Homicide;
- Robbery;
- Rape;
- Arson;
- Burglary;
- Serious assaults;
- Death investigations, not to include natural, unsuspecting deaths;
- Fatal crashes;
- Large scale traffic incidents;
- Ethnic, racial or religious crimes;
- Serial or multiple crime incidents;
- Theft of government equipment, computer, ID card (employee, military, dependent, contractor);
- Theft of police or firefighter equipment (badge or uniform; to include weapons);
- Theft of large vehicles;
- Sovereign citizen encounters;
- Significant drug seizures;
- Crimes involving a firearm or seizure of a firearm;
- Threats of Mass Violence;
- Gang-related crime;



## Administrative and Operational Manual

September 12, 2022

- Civil Disturbances / Protests;
- Search and Seizure Warrant Services at a dwelling or business.

These incidents shall be reported using the Agency computer-based "Crime Report." This report is the responsibility of the employee handling the incident. If indicated by the employee, the information will be used for a press release.

The crime information reports contain confidential information and are intended for law enforcement personnel only. Dissemination of the crime information reports to non-law enforcement personnel, in any format, is prohibited.

### 4-115.2 COMMANDERS' INFORMATION REPORT

This report is a confidential management information document designed to provide command level personnel timely reporting of serious crimes, noteworthy occurrences or unusual incidents. The report shall not be openly circulated within the Agency due to the possibility of sensitive information being divulged and potentially compromising an investigation. Employees other than designated commanders must have a demonstrable need for the information in order to receive the report.

The Commanders' Information Report shall not be disseminated to the media under any circumstances. This report is the responsibility of the supervisor or commander of the employee handling the incident. Incidents which shall be reported include, but are not limited to, the following:

- Agency crashes;
- Shootings involving any law enforcement officers;
- Injured officers;
- When a police officer uses force involving a firearm, baton, pepper spray or any other weapon;
- When a prisoner is injured while in custody by any means or becomes ill and requires medical treatment;
- Incidents involving well-known persons;
- Threats against the courthouse or any person therein;
- Hostage / barricade situations; and/or
- Large-scale arrest situations.

### 4-115.3 COMMANDERS' RESPONSIBILITY

The shift commander, section commander, or other appropriate Agency commander, shall determine the necessity of initiating a Commanders' Information Report for incidents not previously specified. If it is determined the report is required, he shall cause the report to be completed and arrange for dissemination of the report as follows:

- Executive Staff

These incidents shall be reported using the Agency computer-based "Commanders' Report." The report shall be concise and provide an accurate summary of the incident. Highly sensitive information may be deferred and a contact person identified in the report for further information.

Commanders receiving the report will have the authority to disseminate the Commanders' Information Report as they determine necessary, provided that dissemination is not otherwise prohibited.



Administrative and Operational Manual

September 12, 2022

---

#### 4-115.4 COMPUTER SYSTEM OUTAGES

In the event the Agency computer system for distribution of these reports is down, the Commanders' Information Report will be submitted as soon as possible after the computer system is back up.





Administrative and Operational Manual

September 12, 2022

## **4-116 METERS / NCIC COMPUTER SYSTEM**

### **4-116.1 RESPONSIBILITY**

The Terminal Agency Coordinator is within the Information Technology Division. He maintains complete control over the entire NCIC / METERS computer system within the organization. In his absence, one of the alternate TACs will maintain his duties.

### **4-117 AUTHORIZED PERSONNEL TO OPERATE**

Only those persons having successfully completed an initial NCIC access course (NCIC Logon Certification) administered by CJIS and who maintain a current certification shall be authorized to use an NCIC / METERS terminal. Each operator is to sign on before and sign off after using the terminal and required to log on monthly so as not to lose access.

### **4-118 GENERAL RESPONSIBILITIES**

Police Station Technicians with CN1 level access to NCIC / METERS shall be responsible for the following:

- Entering and clearing missing persons;
- Entering and clearing stolen vehicles and tags;
- Making inquiries on persons, property and vehicles;
- Sending messages to other agencies.

The Police Station Technicians / call takers shall operate the computer at the direction of the station officer / supervisor. Technicians assigned to the La Plata District Station shall be responsible for the following:

- warrant hits / confirmations;
- entering and clearing stolen and recovered property from the Town of La Plata Police;
- sending NCIC / METERS messages for the Town of La Plata Police;
- clearing wanted persons; and
- clearing property stolen and recovered in Charles County.

Communications personnel shall be responsible for making inquiries on persons, property and vehicles.

Judicial Service Specialists shall have the responsibility of entering and updating warrants and protective orders.

Each section is responsible for making sure all METERS paperwork is shredded by Agency personnel. No contractual shred companies are to be used to shred METERS paperwork.

## **4-119 COMPUTER INFORMATION TRACKING**

Routinely, employees of this and other Agencies seek METERS, CJIS and NCIC information for investigative purposes either by requesting another employee to query the applicable system or by making the inquiry themselves if certified to do so.

State and federal laws as well as NCIC regulations prohibit accessing this information for other than legitimate law enforcement purposes. Secondary dissemination of this information is strictly controlled and a record of this distribution must be maintained for a minimum of three years. The Criminal History/CJIS Log, Form #868 has



**Administrative and Operational Manual**

**September 12, 2022**

been developed for this purpose. Should secondary dissemination of any criminal history record occur, the employee dispersing the information shall note the inquiry on Form #868.

It is the policy of the Maryland Department of Public Safety and Correctional Services and the CJIS system that Motor Vehicle Administration (MVA) data accessed through CJIS is provided for official government use only. 3-602

Dissemination of MVA data other than to an authorized person or criminal or criminal justice agency is strictly prohibited.

However, for the purpose of this policy, when MVA information is accessed for dissemination to authorized persons, it does not need to be placed on the Criminal History/CJIS Log.

A number associated with the record will be entered on the Criminal History/CJIS Log in the "Identifying Number" section. Examples of these would be:

- FBI Number;
- State Identification (SID) Number.

The "Notes" section will indicate the purpose for the criminal history inquiry if not associated with an incident or event number.

The commander of each facility where a METERS/NCIC terminal or Agency CAD system is located, will ensure an adequate supply of Form #868 are available to staff.

Once all lines on a form have been utilized, it will be forwarded to the ITD. The TAC, within the ITD will be responsible for maintaining each completed form for a period of three (3) years from the date of the last entry on that form.

## **4-120 COMPSTAT PROGRAM**

The CompStat Program examines current crime trends, intelligence, and other information having a direct impact on public safety in the County. CompStat works to help officers be more effective and efficient in preventing and reducing crime and includes the concepts of organizational structure and accountability, crime analysis and mapping, and problem solving. CompStat contributes to the overall strategic management planning process.

CompStat meetings are based on the material contained in a weekly report that will be issued by the CID Crime Analysis Function, which incorporates the principles of accurate and timely intelligence, synchronized and focused rapid deployment, effective tactics, and rigorous follow-up and assessment.

Mapping of crimes is presented, so the locations can be easily identified by location and type of crime. Those in attendance will have the opportunity to actively see and discuss the various crimes and trends, and to work together in reaching possible solutions County-wide and across district station boundaries. Notes from the meetings are forwarded to the command staff, affected Sergeants, the MSP barrack commander, MSP-SMIC, and the Town of La Plata Police, with the overall goal of utilizing the information provided to become more proactive in policing.



Administrative and Operational Manual

September 12, 2022

---

## **4-205 ASSISTING / TRANSPORTING INTOXICATED OR INCAPACITATED PERSONS**

### **4-205.1 PROCEDURES – MAN-DOWN CALLS**

After arriving on the scene of a “man-down” call, officers will attempt to determine whether the individual is sick, injured, or intoxicated.

- If the person is sick or injured and wishes to be transported to the hospital, the officer will request ambulance service through Communications;
- If the person refuses to be transported by ambulance and the officer determines that the person is capable of making a rational decision, no ambulance will be called;
- If the person is merely intoxicated and does not appear to be suffering from an injury or illness, the officer may attempt to take, or send, the individual to his home or to a health facility. This must be done with the individual's permission unless that person has been arrested for a violation of law.

In any event where an individual is unconscious, whether he is believed to be sick, injured or intoxicated, he will be transported by ambulance to the most available health care facility.

### **4-205.2 CHECKING FOR MEDIC ALERT WARNING**

When assisting, transporting or taking into custody any individual who is believed to be intoxicated, sick, or physically dysfunctional, officers will check for a medic alert necklace, bracelet or other identifying device which delineates a medical disability. Any officer who discovers such an identifying device shall take immediate steps to aid the afflicted person. When medical personnel (e.g., ambulance or hospital staff) take custody of an individual wearing a medic alert device, they shall immediately be made cognizant of all pertinent information contained on the medic alert instrument.

## **4-206 DEPARTMENT OF SOCIAL SERVICES**

### **4-206.1 ASSISTANCE CAPABILITY**

The Department of Social Services can render assistance to officers in various situations such as:

- Housing for destitute / stranded persons;
- Child Abuse cases;
- Evictions.

### **4-206.2 REQUEST FOR ASSISTANCE**

Officers will request assistance from Social Services in emergencies only (citizens will be referred to Social Services routinely in other cases).



Administrative and Operational Manual

September 12, 2022

[REDACTED]

[REDACTED]

[REDACTED]

[REDACTED]

[REDACTED]

[REDACTED]

[REDACTED]

[REDACTED]

[REDACTED]

[REDACTED]

[REDACTED]



Administrative and Operational Manual

September 12, 2022

[REDACTED]

[REDACTED]

- [REDACTED]
- [REDACTED]
- [REDACTED]
- [REDACTED]

[REDACTED]

- [REDACTED]
- [REDACTED]
- [REDACTED]
- [REDACTED]

[REDACTED]

[REDACTED]

[REDACTED]

[REDACTED]

[REDACTED]

[REDACTED]

[REDACTED]

- [REDACTED]
- [REDACTED]
- [REDACTED]
- [REDACTED]

[REDACTED]



Administrative and Operational Manual

September 12, 2022

[REDACTED]

[REDACTED]

[REDACTED]

[REDACTED]

[REDACTED]

[REDACTED]

[REDACTED]

[REDACTED]

[REDACTED]

- [REDACTED]
- [REDACTED]
- [REDACTED]

[REDACTED]

[REDACTED]

[REDACTED]

[REDACTED]

[REDACTED]



Administrative and Operational Manual

September 12, 2022

[REDACTED]

[REDACTED]

- [REDACTED]
- [REDACTED]
- [REDACTED]
- [REDACTED]
- [REDACTED]
- [REDACTED]
- [REDACTED]
- [REDACTED]
- [REDACTED]
- [REDACTED]
- [REDACTED]
- [REDACTED]
- [REDACTED]
- [REDACTED]

[REDACTED]

[REDACTED]

[REDACTED]

[REDACTED]



Administrative and Operational Manual

September 12, 2022

[Redacted text block]

[Redacted text block]

[Redacted text block]

[Redacted text block]

**4-209 UNMANNED AERIAL SYSTEM (UAS)**

The UAS Function is responsible for the deployment and use of unmanned aerial systems which can be used for such things as conducting searches for missing or wanted persons, crime scene photography, reconnaissance, for public relations purposes, and assisting the Emergency Services Team in operations and training. All members of the Function will be federally licensed pilots and operate in accordance with FAA Regulations.

The UAS Function falls under the command of the Commander, Field Operations within the Special Operations Division.

When a situation requires the need for a UAS, a command level officer will be contacted and determine if the UAS will be utilized. If the UAS pilot is currently working and available, they will respond to handle the situation. If there is no UAS pilot working or available, the Commander, Field Operations will be contacted to facilitate a callout for a pilot.

If there is a need for a UAS which does not require an immediate response, a request for the UAS can be made by submitting the "UAS Request Form" which can be found on the Agency Intranet under the "Reports" tab on the toolbar. All requests made in this manner will be emailed to the UAS Coordinator who will contact the requester and determine how the request will be handled.

[Redacted text block]

[Redacted text block]

[Redacted text block]

- [Redacted text]
- [Redacted text]
- [Redacted text]

[Redacted text block]

[Redacted text block]





Administrative and Operational Manual

September 12, 2022

[Redacted text block]

[Redacted text block]

[Redacted text block]

[Redacted text block]

- [Redacted list item]
- [Redacted list item]
- [Redacted list item]
- [Redacted list item]

[Redacted text block]

[Redacted text block]

[Redacted text block]

[Redacted text block]

[Redacted text block]

[Redacted text block]

[Redacted text block]

[Redacted text block]

[Redacted text block]



Administrative and Operational Manual

September 12, 2022

---

[REDACTED]

[REDACTED]

[REDACTED]

[REDACTED]

[REDACTED]

[REDACTED]

[REDACTED]

[REDACTED]

[REDACTED]

[REDACTED]

[REDACTED]

[REDACTED]

[REDACTED]

[REDACTED]

[REDACTED]

[REDACTED]

[REDACTED]

[REDACTED]

[REDACTED]

[REDACTED]

[REDACTED]

- [REDACTED]
- [REDACTED]
- [REDACTED]
- [REDACTED]
- [REDACTED]
- [REDACTED]

[REDACTED]

[REDACTED]

[REDACTED]

- [REDACTED]
- [REDACTED]
- [REDACTED]



Administrative and Operational Manual

September 12, 2022

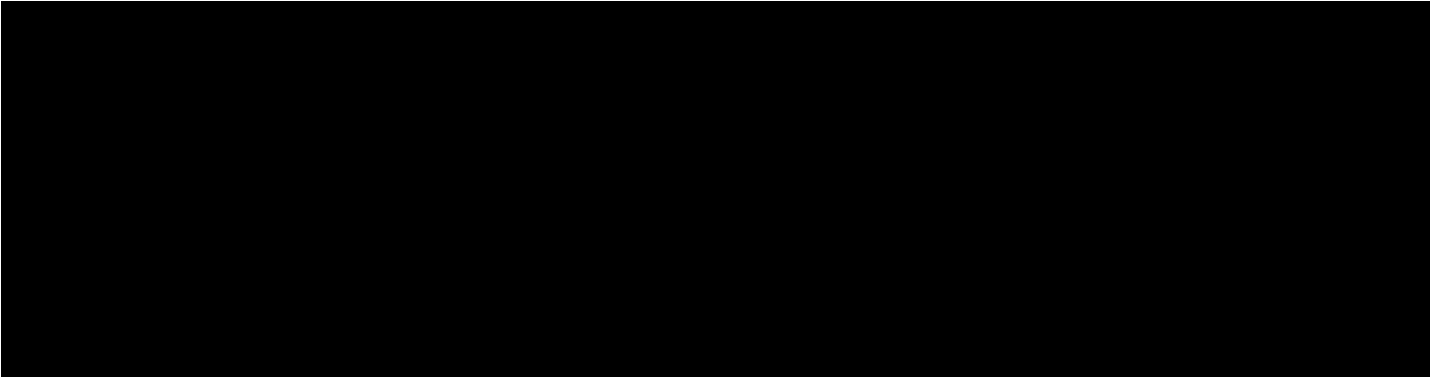

- [Redacted]
- [Redacted]
- [Redacted]
- [Redacted]
- [Redacted]
- [Redacted]
- [Redacted]
- [Redacted]
- [Redacted]

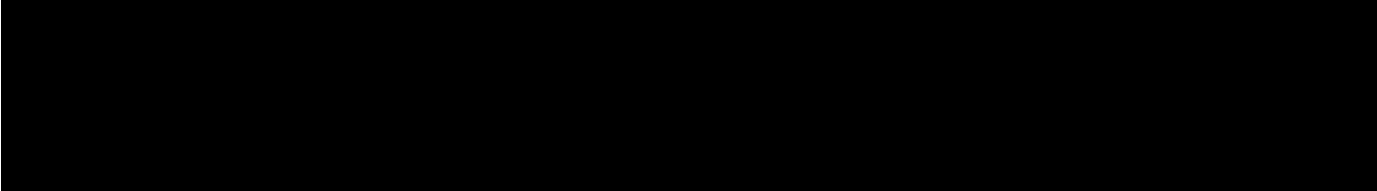
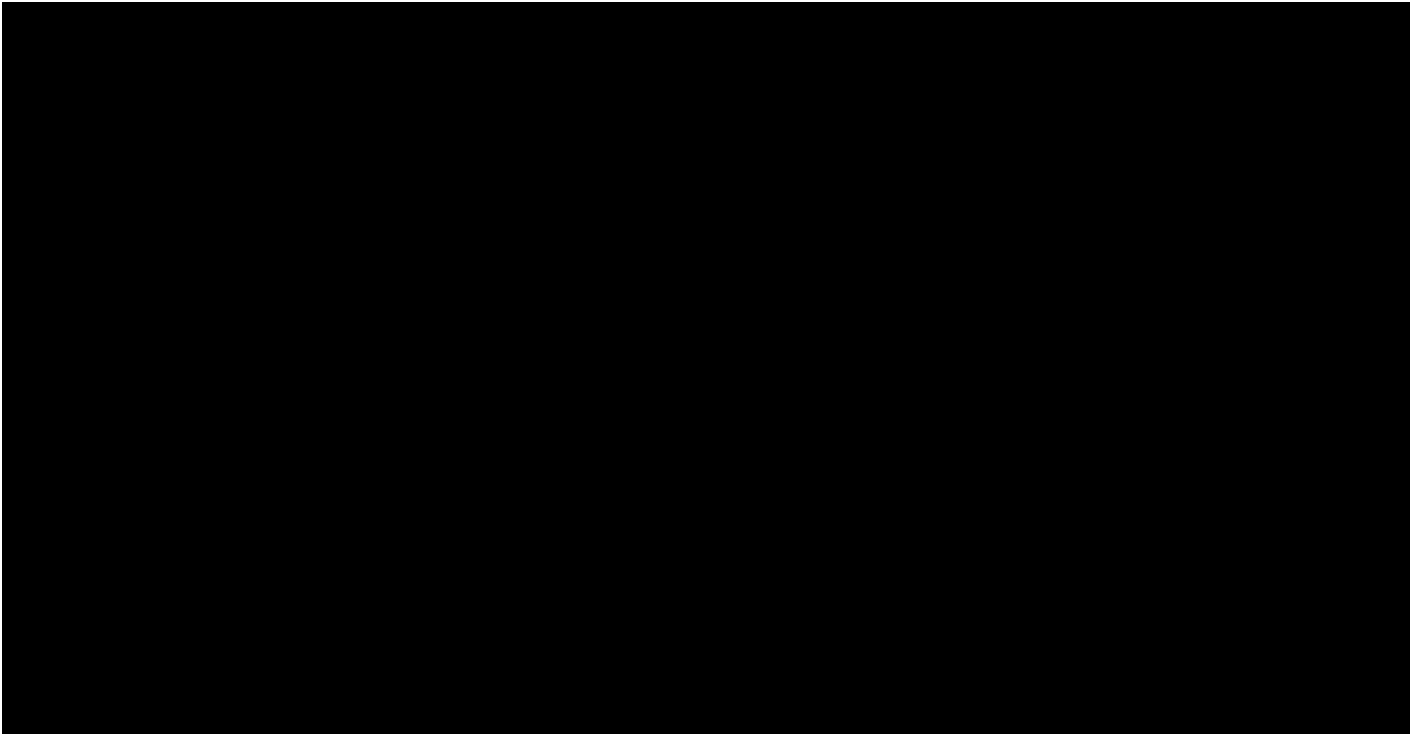



Administrative and Operational Manual

September 12, 2022

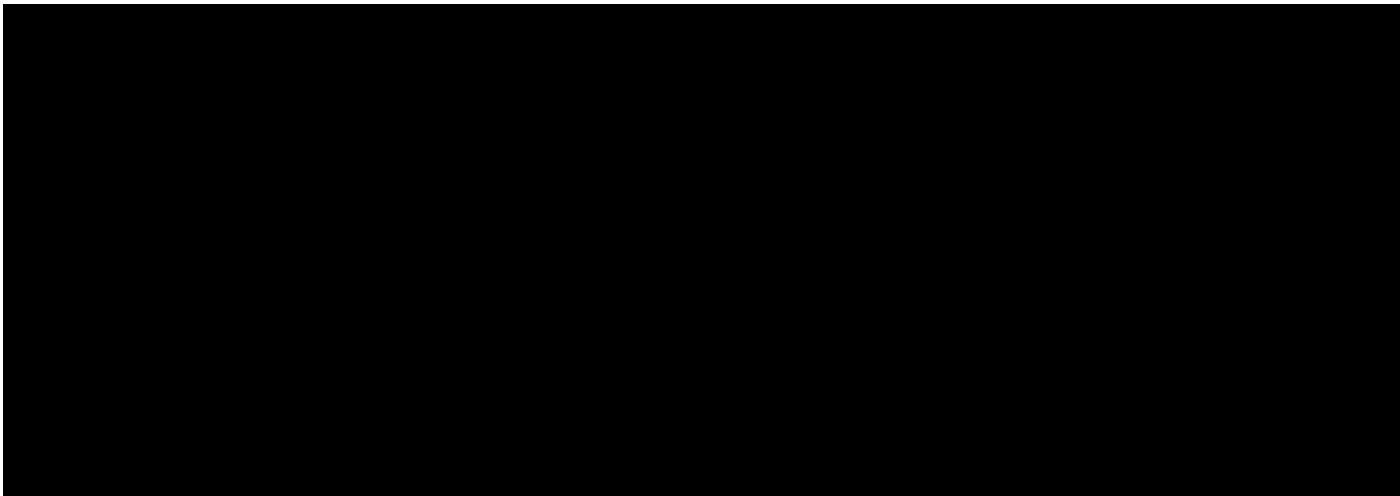



Administrative and Operational Manual

September 12, 2022

[Redacted text block]

[Redacted text block]

[Redacted text block]

- [Redacted list item]
- [Redacted list item]
- [Redacted list item]
- [Redacted list item]
- [Redacted list item]
- [Redacted list item]
- [Redacted list item]
- [Redacted list item]

[Redacted text block]

[Redacted text block]

[Redacted text block]

[Redacted text block]

[Redacted text block]

[Redacted text block]

[Redacted text block]





Administrative and Operational Manual

September 12, 2022

[REDACTED]

[REDACTED]

- [REDACTED]
- [REDACTED]
- [REDACTED]

[REDACTED]

[REDACTED]

- [REDACTED]
- [REDACTED]
- [REDACTED]
- [REDACTED]
- [REDACTED]
- [REDACTED]

[REDACTED]

[REDACTED]

[REDACTED]

[REDACTED]

[REDACTED]

[REDACTED]



Administrative and Operational Manual

September 12, 2022

[REDACTED]

[REDACTED]

- [REDACTED]
- [REDACTED]
- [REDACTED]
- [REDACTED]

- [REDACTED]
- [REDACTED]
- [REDACTED]
- [REDACTED]
- [REDACTED]

[REDACTED]

- [REDACTED]
- [REDACTED]
- [REDACTED]
- [REDACTED]
- [REDACTED]
- [REDACTED]
- [REDACTED]
- [REDACTED]

[REDACTED]





Administrative and Operational Manual

September 12, 2022

- || [REDACTED]
- || [REDACTED]
- || [REDACTED]
- || [REDACTED]
- || [REDACTED]

[REDACTED]

- || [REDACTED]
- || [REDACTED]
- || [REDACTED]

[REDACTED]

- || [REDACTED]
  - || [REDACTED]
  - || [REDACTED]
  - || [REDACTED]

- || [REDACTED]

- || [REDACTED]
- || [REDACTED]

[REDACTED]

- || [REDACTED]
- || [REDACTED]
- || [REDACTED]
- || [REDACTED]

[REDACTED]

- || [REDACTED]
- || [REDACTED]
- || [REDACTED]

[REDACTED]

- || [REDACTED]
- || [REDACTED]
- || [REDACTED]
- || [REDACTED]

[REDACTED] [REDACTED]



Administrative and Operational Manual

September 12, 2022

## 4-212 ASSISTING MOTORISTS

The Agency has a responsibility to provide general assistance and protection and obtain needed services for stranded or disabled motorists using the roadways in the County.

Officers, as part of their routine duties, will be alert for motorists needing assistance. Officers, unless en-route to a call for service, will stop, notify Communications and provide assistance. If unable to immediately stop, officers will advise Communications of the motorist's location and request that another available unit respond. Assistance rendered can include:

- providing information and directions;
- providing mechanical assistance or towing services;
- providing protection and/or transportation in hazardous locations or environments;
- obtaining emergency medical or other services.

## 4-213 VEHICLE LOCKOUTS

Officers who are assigned or possess vehicle entry kits approved for use by the Agency may utilize these devices to perform both routine and emergency entries to vehicles.

The approved device at this time consists of a wedge and/or inflatable wedge to flex the window seam, and a rod to reach into the vehicle compartment to defeat the locking system. "Slim Jims" or similar devices are prohibited, as they are prone to cause damage and/or inadvertently discharge a side impact airbag system.

A call sheet will be generated which will include the vehicle registration and the name of the person requesting this assistance.

Call takers receiving this type of request for assistance will advise the caller the Agency will accept no responsibility for accidental damage to the vehicle. In situations where the request was generated other than through the call center, the responding / assisting officer will ensure the requester is made aware of this waiver of responsibility for accidental damage and will document that this was done in the call sheet.

In every situation, the responding / assisting officer must confirm on the scene that the caller is authorized to operate the vehicle. This may be done by proof of ownership or by other means that satisfy the officer of the caller's authority to waive responsibility for damage (e.g., the caller is the vehicle owner's spouse or dependent, or the caller can somehow verify that he/she is allowed to operate the vehicle). If the officer cannot be satisfied, entry to the vehicle will not be attempted.

### 4-213.1 EMERGENCY ENTRY

An emergency is defined as a situation where life and/or serious physical injury is threatened, or some other compelling law enforcement purpose is to be served by immediately gaining entry to the vehicle.

In an emergency, the preferred method of gaining entry to a vehicle is to break a side window and manually release the door lock.

If the vehicle is occupied, the side window broken should be one that is as far as possible from the occupant or occupants of the vehicle. If the occupant(s) is conscious, the occupant should be instructed to turn away from the window when it is struck to avoid any glass fragments flying into the face. Most side windows are designed to break into many small pieces.



**Administrative and Operational Manual**

**September 12, 2022**

---

Any handy device may be used to break the window, but the preferred device is one which can be held onto in order that it not fly into the vehicle. The issued baton may be used. A handgun or other weapon should not be used because of the danger of accidental discharge.

#### **4-213.2 REQUIRED REPORT**

Any employee who performs an emergency entry into a vehicle as allowed by this policy shall complete a written report of the circumstances surrounding the incident. A separate incident report shall be made if no other report is required to be generated by the circumstances of the particular incident.

The report shall describe the vehicle, including the owner information. The report will describe the nature of any emergency giving rise to the action. The report will describe the damage to the vehicle and any injuries inflicted upon the occupants.

All other necessary reports will be generated in addition to the incident report as may be required by the circumstances.

### **4-214 POLICE ACTIVITIES ON PUBLIC SCHOOL PROPERTY**

#### **4-214.1 GENERAL PATROL PROCEDURES**

General patrol activities of school properties are the responsibility of the patrol officer and supporting K-9 Units.

Officers should periodically patrol school and adjacent properties for truants, gangs, disorders, unusual traffic activities, etc.

Officers will respond to school properties for the purposes of suppressing crime or disorder and taking routine reports.

#### **4-214.2 ARREST ON SCHOOL PROPERTY DURING SCHOOL HOURS**

When possible, arrests will be made away from school property.

Arrests on school premises shall be effected in a manner to avoid embarrassment and jeopardy to pupils.

When an arrest is made during school hours, the arresting officer will provide the responsible school official with sufficient facts to enable that official to adequately advise the parent or guardian regarding the nature of the arrest, location of the pupil, and identity of the officer.

If a full-custody arrest occurs, parental notification will be attempted upon arrival at CCSO facilities, but in all cases will be made within 48 hours, and all notification attempts will be documented.

#### **4-214.3 QUESTIONING ON SCHOOL PREMISES**

Investigative questioning of pupils on school premises shall be conducted only in cases involving:

- A crime committed on the premises;



Administrative and Operational Manual

September 12, 2022

- An investigation in which the safety of pupils or other persons would be unduly endangered if questioning was delayed.

A school official shall be present during such interviews. Students will NOT be removed from school premises merely for the purposes of conducting an investigative interview.

#### 4-214.4 SEARCH AND SEIZURE ON SCHOOL PROPERTY

Police officers possessing a search warrant may search that part of the school premises described in the search warrant.

“Investigative Searches” of school premises by police officers shall be conducted only with an appropriate search warrant or whenever the search is essential to prevent imminent danger to the safety and welfare of a pupil, another person or school property.

Every effort shall be made to conduct searches in a manner which will prevent disruption of the normal school routine and minimize embarrassment to pupils.

Officers will not search the person of a pupil unless the pupil is under arrest, or the officer has a reasonable suspicion that the pupil is concealing a weapon which poses a danger to the pupil, the officer, or other persons. Officers shall not direct a school official to conduct a physical search of a pupil.

Personal possessions of students (including student lockers) will be searched only:

- After regular class hours;
- During regular class hours with the student present;
- With a search warrant;
- To prevent imminent danger to pupils or others;
- Whenever school officials have substantial proof that a serious offense has been or is being committed.

#### 4-214.5 SCHOOL DISORDERS - REQUEST FOR POLICE RESPONSE

Police manpower called to a school should be limited to that number which may reasonably be expected to be required to deal with the situation. On the other hand, it is imperative that a sufficient force be on hand to deal quickly and directly with the crisis situation. This determination as to the level of required force can best be made by the ranking police officer on the scene.

In a variety of non-sensitive situations, the use of uniformed personnel is appropriate, i.e., taking of reports, terminating minor disturbances, assisting in routine police situations, etc.

A response by plainclothes officers is preferable to one by uniformed personnel in all situations where student or faculty sensitivity may crucially influence the success of the short-term investigation required by the law enforcement Agency. These sensitive situations will include most investigations where student informants must come forward and most situations where inter-group tension may be intensified by the presence of uniformed officers.



Administrative and Operational Manual

September 12, 2022

## 4-215 TOW SERVICE PROGRAM

The authorized Tow Service Program of the Charles County Sheriff's Office is a voluntary participation program. It is supervised on behalf of the Sheriff by the Traffic Operations Supervisor. The rules and regulations for tow service owners and operators are contained in the document "Charles County Sheriff's Authorized Tow Service Requirements, Rules, Regulations and Schedule of Fees for Services." This document applies any time a tow truck is requested by the CCSO, even if our call is at the request of the vehicle owner. All employees will report violations of the rules and regulations of this program in writing to the Traffic Operations Supervisor. When needed, a tow service shall be requested as follows:

- when a vehicle owner, operator, or agent desires a specific tow service, the officer shall make the request to Communications (Example: "OWNER'S REQUEST, ABC TOW SERVICE");
- when a vehicle owner, operator or agent has no specific tow service to call, the officer shall make the request to Communications (Example: "OWNER'S REQUEST, CLOSEST AVAILABLE 10-51");
- when a vehicle is impounded by an employee of this Agency, or when a vehicle owner, operator, or agent is not present or is incapable of making a request for any reason, the request to Communications will be: "MY REQUEST, CLOSEST AVAILABLE 10-51."

**NOTE:** Officers are prohibited from suggesting specific tow services for any reason to any vehicle owner, operator or agent.

The officer will provide Communications with the following information for each vehicle to be towed:

- make, model, approximate year, and condition of the vehicle to be towed;
- a brief description of the scene relative to that vehicle.

Officers shall not request specific types of tow equipment unless authorized to do so by the Traffic Operations Supervisor. Communications will relay information received to the tow service and the tow service will determine the appropriate tow equipment.

Communications will advise the officer which tow service will be responding and for which vehicle. Upon arrival of the dispatched tow service on the scene, the requesting officer will notify Communications of the tow service's arrival.

Prior to a tow service departing the scene, the officer requesting the tow service will designate the towed vehicle as either "TOWED" or "STORED."

"TOWED" means we have simply provided a service to the vehicle owner or operator by calling assistance for him / her. Towed vehicles may be reclaimed by the owner by merely paying the tow bill.

"STORED" means we have taken possession of the vehicle, even if our possession is temporary. "STORED" means the same as "IMPOUNDED." Stored vehicles will have a Vehicle Storage Card prepared by the storing officer. To reclaim the vehicle, it must be released via a Motor Vehicle Release Card.

It should be remembered for this program to work properly, we must assist the tow service as much as possible and be consistent with our duties. The safety of the motoring public and those personnel on the scene is our responsibility and we must act accordingly to ensure that safety.



**Administrative and Operational Manual**

**September 12, 2022**

#### **4-215.1 LIST OF APPROVED TOW SERVICE OPERATORS**

The Traffic Operations Supervisor shall be responsible to maintain a list of all the Tow Service Operators who have signed an agreement to operate within the guidelines of this program. The list shall be continually updated to reflect any new operators and any who are removed. The Traffic Operations Supervisor shall provide a copy of the list to the Commander, Communications Section and provide any updates as they occur.

The list of Tow Service Operators shall contain the:

- name of the company;
- name of the owner or resident agent;
- business address of the company, with directions;
- business telephone number of the company;
- address of the impound lot if it is different than the company address;
- hours of operation of the business; and
- type of towing equipment available.

#### **4-216 CCSO AUTHORIZED TOW SERVICES; REQUIREMENTS, RULES, REGULATIONS AND SCHEDULE OF FEES FOR SERVICES, AND APPLICATION**

The Authorized Tow Services Requirements, Rules, Regulations and Schedule of Fees for Services Form #397 and the Application for Authorized Tow Services Program Form #395, will be maintained by the Traffic Operations Supervisor.

The Traffic Operations Supervisor will make available in each district station copies of these documents for the use of the staff and the general public.

The Traffic Operations Supervisor will notify Agency personnel (Communications, Records, Commander of Property Management, division commanders, etc.) of all necessary information (telephone number, address, directions to tow service or any other relevant information) when tow services are added, deleted or changed.

Traffic Operations officers will be knowledgeable of and maintain a familiarity with the entirety of these documents. Other officers and Communications personnel will be cognizant of the fact that amongst other regulations, these documents require the following to be adhered to:

- the promise of, or giving of, any special favor or gift by any tow service, or tow service employee or owner to any CCSO employee is prohibited. Such activity must be immediately reported to Office of Professional Responsibility, and may be subject to disciplinary action;
- tow company equipment or personnel are not permitted to respond to the scene of Charles County Sheriff's Office operations unless requested to do so by CCSO personnel;
- tow company personnel must respond in a timely fashion, obeying all traffic laws. They must provide an estimated time of arrival when they are called. Failure to respond in a timely manner will result in their request being canceled and another tow service being called to the scene;
- tow service personnel will remove from the highway any glass or other injurious substance dropped from a wrecked or damaged vehicle in compliance with Maryland Vehicle Law (TR § 21-1111(c)). Medical waste will be removed or washed down by the Fire Service and hazardous materials and fluids will be the



Administrative and Operational Manual

September 12, 2022

- responsibility of County Roads or the State Highway Administration;
- tow service personnel will cooperate fully with Sheriff's Office personnel, and will not leave the scene of our operations until released by the officer in charge of the scene.

## 4-217 STORAGE OF VEHICLES

Vehicle Storage Cards will be maintained at the front desk of the district station where the vehicle was stored; i.e., for a vehicle towed / stored from the Bryans Road Shopping Center, the Storage Card will be retained at the District II Station.

Officers will inform those individuals of the process of recovering their towed / stored vehicles. Station clerks will process requests for release of stored vehicles as noted in Section 4-217.16. Once a Vehicle Storage Card has been processed and the vehicle released, the Storage Card will be sent to Records for filing.

### 4-217.1 VEHICLES INVOLVED IN ACCIDENTS

Motor vehicles involved in accidents will be stored or impounded if:

- the accident resulted in injury to any person; or
- the vehicle cannot be driven; and
- all persons having custodial interest in the vehicle have been removed from the scene; or
- the vehicle creates a hazard (exposure to danger, risk); or
- the vehicle can be driven but there is no person with a custodial interest to remove the vehicle from the scene.

Any vehicle involved in a fatal accident, or whenever further investigation is required, will be impounded and appropriately inspected. The Vehicle Storage Card will be marked at the bottom of the top portion "Do Not Release." Once the inspection is completed, the investigating officer will contact the front desk at the district station where the vehicle was stored and request this notation be removed.

If an owner / operator requests a disabled vehicle be removed from the scene, we will facilitate the request by calling either the requested tow service or the nearest available. This vehicle will then be considered towed, not stored or impounded by us.

### 4-217.2 ILLEGALLY PARKED VEHICLES

Vehicles shall not be routinely impounded for parking violations. If practical, the officer should give the owner / operator a reasonable opportunity to remove the vehicle. (This in no way restricts officers from issuing appropriate violation notices or summonses.) However, if the nature of the parking violation is such that an officer feels impoundment cannot be delayed, it is authorized in the following circumstances:

- whenever a vehicle is parked or standing in such a fashion that impedes the movement of traffic or blocks a driveway or entrance, or is left unattended on any road, highway, alley or parking lot in a manner which constitutes a threat to public safety;
- whenever a vehicle is parked in a fire lane, or interferes with access to a fire hydrant, or interferes with the passage of an emergency vehicle;
- whenever a vehicle is parked on a snow emergency route and interferes with snow removal efforts or



Administrative and Operational Manual

September 12, 2022

impedes traffic during a snow emergency.

#### **4-217.3 OPERATOR ARRESTED**

If the operator of a motor vehicle is arrested and can arrange immediate legal removal of the vehicle, the vehicle will not be impounded. Vehicles may be searched incident to arrest. Officers are reminded to exercise sound judgment in these instances.

#### **4-217.4 DIPLOMATIC VEHICLES**

Vehicles owned by a person who enjoys diplomatic immunity will not be impounded unless requested by the diplomat. If necessary, a wrecker will be called to move any "DPL" vehicle creating a safety or traffic hazard. However, it will be moved no further than the closest available legal parking place. Payment will be made by Accounting Section out of the "Auto Fund" with approval of a sector supervisor or above.

#### **4-217.5 VEHICLES WITH DEFECTIVE EQUIPMENT**

Vehicles with defective, deficient or altered equipment should not be impounded unless the continued operation of such a vehicle poses an immediate danger to persons or property. Such vehicles may be legally parked at the officer's discretion.

#### **4-217.6 RECOVERED STOLEN VEHICLES**

Vehicles recovered in stolen or unauthorized use cases will be impounded. A Vehicle Storage Card and Motor Vehicle Release Card will be completed. However, if the owner of the vehicle lives close to the recovery location, and the vehicle appears operable, the officer should make an attempt to contact the owner via Communications and request he respond immediately to the scene to take custody of the vehicle. If the owner is able to respond to take custody of the vehicle, this information will be noted in the I.R. and no Vehicle Storage Card is necessary.

Officers will make every attempt to process all recovered autos for latent fingerprints and physical evidence.

#### **4-217.7 VEHICLES WITH MISSING OR ALTERED VEHICLE IDENTIFICATION NUMBERS**

Vehicles with missing, altered or obliterated vehicle identification numbers will be impounded if the vehicle is not displaying an assigned number from the Motor Vehicle Administration.

#### **4-217.8 PERSONS TO PROVE AUTHORIZED POSSESSION**

Vehicles shall not be impounded solely because the owner or operator does not have a registration card available, unless there are no other reasonable means to establish ownership or authorized possession to the satisfaction of the officer.





Administrative and Operational Manual

September 12, 2022

---

## 4-217.9 VEHICLES STORED FOR EVIDENTIARY PURPOSES

There are occasions when motor vehicles require processing for possible evidence collection. For instances in which the vehicle must be maintained in a secure facility pending processing, the vehicles should be towed and stored in the secure fenced-in lot or placed inside the secure evidence bay at the Forensic Science Unit.

If a vehicle is to be stored at FSU during business hours, the storing officer will make appropriate arrangements with the FSU technicians when storing the vehicle. If a vehicle will be stored at FSU after normal business hours, the storing officer will access the rear door of the lab using his swipe key and then disarm the alarm. The gate key is stored above the alarm panel.

If a motor vehicle is towed to and stored at the Forensic Science Unit facility, the following procedures will occur:

- A Stored / Processed Vehicle Report Form #518 will be completed by the storing officer, indicating why the vehicle was stored and what processing is requested;
- The Stored / Processed Vehicle Report will be placed in a designated tray inside the FSU evidence bay along with the keys to the vehicle, if available;
- A Vehicle Storage Card must be completed and turned in along with a copy of the tow bill to the station clerk at the appropriate district station so the CAD report can be updated. **Do not leave the storage card or tow bill at FSU;**
- After the vehicle has been processed, the FSU technician will make contact with the investigating officer to make disposition on the vehicle;
- The investigating officer will be responsible for contacting the vehicle owner and instructing them on how and where to pick up their vehicle. The victim will have 72 hours to pick up their vehicle from FSU after notification or processing is complete. If other arrangements have not been made and the vehicle owner has not picked up their vehicle after 72 hours, it will be towed to the lot of the original towing company. The investigating officer will also be responsible for updating whether the vehicle may be released on the Vehicle Storage Card.
- If the vehicle will be stored by the original tow company that towed the vehicle to FSU, the FSU technician will contact the tow company and make arrangements for them to retrieve the vehicle and store it at their lot;
- The FSU technician processing the vehicle will be responsible for contacting the station clerk to have the stored location updated on the Vehicle Storage Card.

Depending on what type of processing is requested, vehicles may be stored either in the secure fenced-in lot at FSU or in the evidence bay at FSU.

- If the exterior of the vehicle is to be processed for evidence (i.e., latent fingerprints, blood, etc.) the vehicle must be secured inside the evidence bay;
- If the exterior of the vehicle is to be processed and there is no space inside the evidence bay, the vehicle may be secured inside the secured fenced-in lot at FSU; however, the Supervisor of FSU must be contacted immediately to make arrangements to have the vehicle moved into the evidence bay as soon as space can be made available;



**Administrative and Operational Manual**

**September 12, 2022**

- Vehicles which do not require the exterior to be processed may be stored in the secured fenced-in lot at FSU.

If a vehicle is towed to FSU and the Stored / Processed Vehicle Report is not completed, FSU technicians will attempt to determine who stored the vehicle at FSU and why it was stored. If after 72 hours, the technician is unable to contact the storing officer or determine why the vehicle was stored at FSU, the original tow company will be contacted to retrieve the vehicle and it will be stored at their lot. The FSU technician will have the vehicle stored location changed on the Vehicle Storage Card.

After the vehicle has been processed, the FSU technician will make contact with the investigating officer to make disposition on the vehicle. It is the responsibility of the CID Commander to determine who is responsible for payment of the tow bill. If CCSO is going to make payment, the investigating officer will complete a requisition for payment of the tow bill. A copy of the tow bill, along with the requisition, will be reviewed by the CID Commander and forwarded through the chain of command to the Accounting Office for final review and payment. If payment is to be made by the owner of the vehicle or by another entity, the investigating officer will contact the owner and advise them this must be done prior to releasing the vehicle.

#### **4-217.10 NARCOTIC RELATED STORAGE**

When a vehicle is stored in connection with drug related violations, the vehicle will be towed to, and stored inside the fenced area of Property Management. Prior to securing from duty, the officer storing the vehicle will forward to the Commander of Property Management the following:

- completed Vehicle Storage Card;
- Registration Card and computer printout of the vehicle registration information;
- Vehicle Seizure Form;
- Copy of charging documents if arrests are made relating to the storage;
- tow bill;
- keys to the vehicle (all other keys, key rings, etc., will be left inside the vehicle);
- The storing officer shall make all reasonable efforts to ensure the vehicle is closed to prevent damage from inclement weather; i.e., door completely closed, windows up, trunk / hood closed, broken windows covered.

The Commander of Property Management and the Asset Forfeiture Investigator will be responsible for release or other disposition of the vehicle.

As soon as practical after storage the Asset Forfeiture Investigator or designee will begin follow-up on vehicles stored in connection with narcotics violations to include inventory of the vehicle and verification of the vehicle identification number.

#### **4-217.11 ABANDONED VEHICLE / INOPERABLE, PUBLIC OR PRIVATE PROPERTY**

Vehicles defined as abandoned by the Transportation Article (TR § 25-201) of the Annotated Code of Maryland will be tagged with an abandoned and disabled orange sticker (Violation Notice Form #74). If not removed within 48 hours after tagging, the vehicle may be impounded. This pertains to vehicles abandoned on public or private property (without permission of the owner or lessee). In addition, charges can be brought under the Transportation Article (TR § 25-202) of the Annotated Code of Maryland.

#### **4-217.12 UNATTENDED / DISABLED VEHICLES ON PUBLIC PROPERTY**



**Administrative and Operational Manual**

**September 12, 2022**

The investigating officer will check the vehicle for wanted / stolen. If the vehicle is not wanted / stolen, and is parked lawfully and not creating a public hazard, the officer will affix an abandoned and disabled orange sticker (Violation Notice Form #74) in a conspicuous place on the vehicle. The Traffic Operations Section will be responsible for follow-up. If an unattended / disabled vehicle remains on public property for 48 hours, it may be stored (impounded).

Vehicles creating a traffic safety or health hazard will be stored (impounded) immediately.

**4-217.13 VEHICLES ON PRIVATE PROPERTY**

Vehicles on private property may be removed and stored (impounded) for evidentiary purposes, or if abandoned (after tagging and 48 hours). It is the intent of this section to allow officers to assist owners of private residences only with vehicles abandoned on their property.

Vehicles abandoned at shopping centers, apartment complexes or other commercial property will be removed only in unusual cases with supervisory approval. Property owners, including owners of private parking lots, may have vehicles removed from their property themselves under different circumstances; however, Sheriff's Officers will not become involved except as conservators of the peace, or if a violation of law takes place.

**4-217.14 OFFICER'S RESPONSIBILITIES WHEN TOWING VEHICLES**

When an officer calls for a tow for a citizen, the officer will be responsible to accomplish the following:

- Obtain registration information via registration card, computer inquiry or any other documentation that can be located;
- Check for wanted / stolen;
- If the owner is not the driver, obtain the driver's information and have this information entered in the CAD event listing; and
- Complete a Vehicle Storage Card if ownership or custodial interest cannot be determined.

**4-217.14.1 OFFICER'S RESPONSIBILITIES WHEN STORING VEHICLES**

When officer stores (impounds) a vehicle (as opposed to simply calling for a tow for a citizen), the officer shall be responsible to accomplish the following:

- Obtain registration information via registration card, computer inquiry or any other documentation that can be located;
- Check for wanted / stolen;
- Attempt to contact the last registered owner in person, by telephone or by completion of the Notice of Stored Vehicle Letter Form #37. In those instances where a "Notice of Stored Vehicle" letter is utilized, it will be prepared by the officer and forwarded to Records for mailing via certified mail;
- Complete a Charles County Sheriff Vehicle Storage Card Form #68, which will be turned in to an officer of supervisory rank prior to securing from the tour of duty. If for any reason the vehicle cannot be released,



**Administrative and Operational Manual**

**September 12, 2022**

this should be prominently noted in the lower portion of the top half of the form. The officer of supervisory rank receiving the Vehicle Storage Card will check it for accuracy and completeness, then affix his initials, ID number and date at the bottom of the top portion, prior to it being filed. A file of Vehicle Storage Cards will be maintained at the front desk area of the district station where the vehicle was stored.

If mail notification of storage is returned from the postal service marked "unclaimed" or "undelivered," Records will forward a copy of the Vehicle Storage Card, Notice of Stored Vehicle Letter Form #37 and copy of certified mail receipt card to the Traffic Operations Supervisor, who will take the steps necessary to issue a "CS 78" to the towing service upon their request.

#### **4-217.15 STORED VEHICLE OF UNKNOWN OWNER(S)**

Whenever a vehicle is stored and the last registered owner is unknown, the storing officer will be responsible for the following:

- Preparation of an Offense / Incident Report Form #20;
- Completion of Vehicle Storage Card Form #68 with all computer inquiry replies attached.

These steps will be completed prior to securing from duty in the same manner as set forth elsewhere in this Manual.

The Offense / Incident Report shall be marked "follow-up by investigating officer" who will submit follow-up supplements no later than the 7th and 14th day from the storage date. If by the 21st day from storage, all investigative leads have been exhausted and the owner remains unknown, a third supplement will be prepared requesting the case be closed.

#### **4-217.16 ISSUANCE OF VEHICLE RELEASE**

A Vehicle Release will not be denied to a person who has produced personal identification and adequate documentary evidence that he is entitled to the vehicle unless the vehicle is impounded for evidentiary purposes; or for having a missing, altered or questionable vehicle identification number, or pursuant to a narcotic related storage as set forth elsewhere in this policy. Such documentary evidence will be required when a person other than the last titled owner / co-owner is requesting release. These documents must be reproduced and attached to the original release form.

Examples of adequate documentary evidence include (but are not limited to) one or more of the following:

- Certificate of Title;
- Notarized Authorization - must contain vehicle VIN and to whom release is authorized;
- Properly endorsed Certificate of Title (has signature of seller and information on purchaser inserted in appropriate location);
- Power of Attorney;
- Official Designation as Administrator of an Estate.

If the owner is an inmate:

- Detention Center Release witnessed by a Corrections Officer.

The vehicle owner will not be denied a release for a vehicle solely because of refusal to sign a Maryland Uniform Complaint and Citation.



Administrative and Operational Manual

September 12, 2022

**NOTE:** vehicles stored in connection with narcotics violations will be treated as directed in the section governing narcotics related storage.

#### 4-217.17 RELEASE FOLLOWING REQUEST FOR TOWING SERVICES

When a wrecker has been called for a vehicle storage and the owner / custodian arrives at the scene prior to wrecker hook-up, the officer will release the vehicle to the owner / custodian without compensation to the wrecker operator.

If the wrecker has hooked up to the vehicle but has not departed the scene prior to the arrival of the owner / custodian, the vehicle will be released upon an agreement between the tow service operator and the vehicle's owner / custodian.

#### 4-217.18 GENERAL VEHICLE STORAGE GUIDELINES

It is the policy of this Agency to inventory all stored (impounded) vehicles for property of value, such as currency, securities, jewelry, electronic and photographic equipment, tools, clothing, etc. Vehicle inventories are done for the purpose of safeguarding property of value, not as a search for evidence or contraband. The Supreme Court of the United States has specifically ruled that, where conducted purely for administrative reasons and not for any investigative purpose, an inventory of a lawfully seized vehicle's contents does not violate the Fourth Amendment. The inventory is considered a "police caretaking procedure," and it is permitted for the protection of the owner's property, to avoid police liability for loss of the property while the vehicle is in custody, and for safety reasons (i.e., to ensure that no explosive, flammable, or otherwise hazardous devices or substances are present in the vehicle). Inventories will be done by the storing officer and a list of all property of value will be recorded on the reverse of, or attached to, the Vehicle Storage Card. Should any evidence or contraband be discovered, it shall be seized and documented in accordance with Section 4-500 and Section 5-100 of this Manual.

#### 4-217.19 VEHICLE INVENTORY PROCEDURES

Inventory searches of a vehicle are justified if they are:

- pursuant to a lawful impoundment or seizure; and
- part of the standard police procedure and normal practice of the Agency.

When conducting an inventory of a vehicle as prescribed in Section 4-217.18, officers shall:

- Inventory all property of value in the passenger compartment of the vehicle; and
- Inventory all property of value contained in installed storage areas of the vehicle (i.e., glove compartments, consoles, map pockets, saddle bags, permanently mounted "tool" boxes, etc.); and
- Inventory all property of value contained in the luggage compartment of the vehicle (i.e., trunk, roof carrier, etc.).

Officers may open any closed, but unlocked, portable containers found in the stored vehicle for the purpose of confirming and documenting the contents thereof (i.e., camera cases, suitcases, toolboxes, briefcases, tackle boxes, etc.). If the container is locked, the container itself shall be documented and described as locked.

Dependent upon the type of property located, it will either remain in the vehicle or be placed in Property Held. Items such as jewelry, weapons and electronic equipment will be recorded on a Property Held Form #60 and placed in Property Held. The results of the inventory search shall be recorded in a written report, using Vehicle Storage Form



**Administrative and Operational Manual**

**September 12, 2022**

---

#68, completed as a result of the vehicle impound. All contents of the vehicle should be documented in this report. Tools, clothing and the like may remain in the vehicle, provided the property is secure and protected from the elements. Property of value remaining in the vehicle will be recorded on the back of the Vehicle Storage Card.

The inventory process should include an examination of the exterior of the vehicle. Any damage existing at the time of impoundment should be noted, to protect the Agency against a subsequent claim that the vehicle was damaged while in police custody.



## **4-218 RESERVED PARKING AT HEADQUARTERS AND THE DETENTION CENTER**

### **4-218.1 GENERAL POLICY**

Some reserve parking spaces have been established.

Those officers / civilians assigned an individual parking space shall park in the assigned space.

Those spaces marked police vehicles are for police vehicles only.



Administrative and Operational Manual

September 12, 2022

## 4-219 USE OF AGENCY VEHICLES

(See also: Chap. 6-600)

Many of the functions of the Charles County Sheriff's Office require employees to use Agency vehicles. The purpose of this section, and associated sections of the Manual, is to provide guidance and regulation for that use. No part of these sections is intended to supplant vehicle law or other law governing the use and operation of vehicles in general. The intent of these sections is to provide additional guidance and regulation, in supplement to law.

The use of Charles County Sheriff's Office vehicles, off-duty, may occur under the conditions established in this policy. Off-duty use is not a condition of employment nor an assurance or guarantee of any kind. Such use may be individually or summarily limited, suspended or revoked as may, in the opinion of the Sheriff, be in the best interests of the Charles County Sheriff's Office.

### 4-219.1 MANDATORY USE OF SAFETY RESTRAINT DEVICES

Employees operating Charles County Sheriff's Office or other County vehicles shall wear the available seat belt or seat and shoulder harness combination in compliance with Maryland vehicle laws. These devices shall be used in the intended manner as indicated in the manufacturer's manual for the vehicle. It shall be the responsibility of the employee operating the vehicle to require the use of seat belt or seat and shoulder harness combination by all passengers within the vehicle. Prisoners being transported in a vehicle shall be secured utilizing the safety restraints provided in the transport vehicle. Only in emergency situations requiring an immediate removal from a scene will more persons be transported than there are seat positions with these devices available.

Children will not be transported, except in an emergency, unless they are restrained as required by the Maryland Vehicle Law. Child safety seats shall not be in the passenger compartment while the vehicle is being used on-duty unless the officer's assignment necessitates its presence or the officer is transporting a child requiring use of such a seat by Vehicle Law. Child safety seats will not be used in the front seat if there is an air bag for the right front seat.

### 4-219.2 EMPLOYEE VEHICLE ASSIGNMENTS

This Agency has a personally assigned vehicle program. Under this program, it is anticipated each full-time sworn police officer will be assigned a particular vehicle for use during both on-duty and off-duty hours. Certain civilian and correctional officer positions may also be assigned a particular vehicle for use during both on-duty and off-duty hours. Any employee who is assigned a vehicle under this program is responsible for the care, service, and maintenance of that vehicle and all associated equipment as required by the policies of this Agency.

Employees who are assigned a vehicle and who live outside the geographical boundaries of Charles County must park the vehicle in Charles County at the completion of their tour of duty, unless prior written permission of an Assistant Sheriff has been obtained. Permitted parking locations include:

- Charles County Sheriff's Facilities and Charles County Fire or Rescue Stations;
- the Maryland Department of State Police Barrack in La Plata;
- Maryland Transportation Police Facilities within Charles County; or
- the private residence of another Sheriff's Office Employee.

The employee who parks a vehicle at one of these places must obtain permission from the person in charge of such facility or residence; and there must be reasonable security of the vehicle at the parking location. Permission shall be obtained in writing in order that there be no misunderstanding of the granting of permission at a later date. This permission letter shall be submitted to the employee's division commander / director, who will forward a copy to the Commander, Special Services Division and forward the original to Human Resources Section for inclusion in the





**Administrative and Operational Manual**

**September 12, 2022**

employee's personnel file. Sworn police officers and Correctional Officers who are assigned Agency vehicles and who live outside Charles County may use the vehicle the same as employees residing in Charles County during their off-duty hours so long as they remain within the geographical confines of Charles County.

### **4-219.3 REQUESTING AUTHORIZATION TO DRIVE AGENCY VEHICLES OUT OF CHARLES COUNTY**

In some cases, employees who reside outside of Charles County or the State of Maryland may be granted permission by an Assistant Sheriff, via a Request to Drive Agency Vehicle To Out of County Residence Form #530, to drive their assigned vehicles to and from work. This exception to the previously stated policy will be for the benefit of the Agency in providing for immediate response of an off-duty employee to an Agency need for that employee's presence at a work assignment. When this authorization is granted, and the employee is not working in an official employment capacity, the vehicle will not be driven outside of Charles County, except for the authorized travel to and from work.

Executive Command Staff members, who are by the nature of their responsibilities required to respond and manage any situation which may require their attention, may operate their assigned vehicles when they are outside of Charles County, and are exempt from the completion of a Request to Drive Agency Vehicle To Out of County Residence Form #530.

The completed Request to Drive Agency Vehicle To Out of County Residence Form #530, will be forwarded through the requesting employee's commander/ director with the proper endorsements. The Form #530 will reflect the address outside of Charles County where the employee resides (or will reside if the request applies to an anticipated move) and plans to park the vehicle. It will further indicate the measured driving distance, by the most direct route from the closest access point by road to the Charles County line, to this location. This distance shall not exceed twenty-five (25) miles.

The request will also contain the name of a supervisor who has verified the distance between the employee's residence and the closest access point by road to the Charles County line. The verifying supervisor will recommend approval or disapproval of the request prior to it being forwarded to the section commander and division commander/ director. The division commander/ director will forward requests to an Assistant Sheriff for approval. Recommendations for approval or disapproval will be noted on the form.

Upon approval, requests will be distributed by the Assistant Sheriff or his designee in the following manner:

- original to HR;
- copy to the employee's section commander;
- copy to the employee's division commander/ director;
- copy to the Commander, Special Services Division; and
- copy to the employee.

Employees are encouraged to purchase and maintain a personal umbrella insurance policy, particularly those employees utilizing Agency vehicles out of state. Although Maryland law places limits on damages in most claims against government agencies and officials, other states' laws do not. An umbrella policy would provide protection to an employee should a civil judgment exceed the scope of the County's insurance coverage.

### **4-219.4 OFF-DUTY USE OF ASSIGNED VEHICLES**

In order for the Sheriff to reasonably and accurately evaluate the costs and benefits of the off-duty use of Agency vehicles, employees are required to report their activities during off-duty use of Agency vehicles. Officers will report via radio transmission each instance where the officer performs some Agency activity off-duty. Communications shall record this activity the same as on-duty activities are recorded, except it shall be noted the activity was



**Administrative and Operational Manual**

**September 12, 2022**

performed by an off-duty unit. Reportable activities include, but are not limited to:

- response to a radio call for service;
- backup of an on-duty unit;
- self-initiated enforcement activity;
- observation and reporting of traffic hazards; i.e., traffic signal malfunction, trees down in the roadway, road defects needing repair, traffic signs needing repair and so forth;
- assisting a stranded motorist; or
- providing directions and information.

All mileage accumulated on Agency vehicles will be documented and submitted to Fleet Management each month with the link provided on the Agency Intranet. Each division or component assigned pool vehicles is responsible for the on- or off-duty use of that vehicle as explained in Section 4-224.

Employees who have obtained permission, through approval of a request to work secondary employment using an Agency vehicle, may drive that vehicle to and from the secondary employment location. The vehicle may also be used for the commute to and from assigned court appearances, Agency training and other administrative assignments and duties.

No employee may operate a vehicle outside of the geographical boundaries of Charles County, Maryland, when that employee is not working in an official employment capacity, unless such operation is in conformance with a specific exception or condition granted elsewhere in this policy. Executive Command Staff members, including those in the Corrections Division, who are by the nature of their responsibilities required to respond and manage any situation which may require their attention, may operate their assigned vehicles when they are outside of Charles County, so long as they are within a reasonable distance, which would allow them to respond and attend to their duties.

Civilian employees will not utilize Agency vehicles during off-duty hours except to commute to and from their required duties or as specifically authorized in writing by the Sheriff.

#### **4-219.5 CONDITIONS OF USE**

Employees operating vehicles under this section will adhere to the following conditions of use:

- Vehicles will not be taken outside of Charles County unless specifically authorized by command personnel (command personnel may authorize such out-of-County use only for a specific “benefit of the Agency” purpose; and no exception to the dictates of 4-219.3, regarding employees residing outside of Charles County, may be authorized, except by written permission of an Assistant Sheriff.
- Sworn Police and Correctional Officers who reside out of the county are permitted to use their Agency vehicle to commute to and from a work-out facility, gym, or Agency designated fitness area (i.e., Headquarters, District III, etc.), provided the facility or gym is within Charles County, within a five (5) mile radius of their home, or within one (1) mile or less of their regular and reasonable commute to and from their assigned on-duty work or Agency approved location.
- Objects will not be attached to the installed safety screen within the vehicle which will interfere with the driver’s view from the vehicle (particularly those which may prohibit safe backing of the vehicle).
- Vehicles will not be used in conjunction with secondary employment unless the vehicle use has been noted on approved Secondary Employment Request Form #185 completed and approved in conjunction with the secondary employment.



Administrative and Operational Manual

September 12, 2022

- Vehicles will not be left unattended for any prolonged period. This does not preclude employees going into a building with the vehicle parked outside in order to attend to activities therein. Vehicles will not be left at any location for the purpose of the employee receiving money, goods, services or a profit of any kind, because of that vehicle's placement.
- Operation of vehicles at any time when the employee operator has consumed or has in his blood any amount of an alcoholic beverage is prohibited.
- Vehicles will not be used to carry excessive loads or protruding objects, unless transporting found or recovered property.
- The police radio will be monitored and kept on the frequency for the area in which the vehicle is being operated.
- Sworn police officers will attend to matters of an immediate nature which may require enforcement action and come to their attention during the off-duty operation of a Sheriff's Office or County vehicle. For incidents not requiring immediate action, an on-duty officer may be requested.
- All sworn police officers who are assigned an Agency vehicle for their use during off-duty hours will notify Communications of any off-duty police action they perform.
- Employees who are not fit or capable of performing their duties shall not operate a marked Agency vehicle.
- Civilian employees will not operate vehicles in an emergency response mode unless such operation is specifically authorized as a part of their position description and the employee has been formally trained in emergency vehicle operation as recorded in the training records of the Agency.
- Civilian employees will not operate Agency vehicles outside Charles County unless such operation is required by their duties, they are commuting to and from work in accordance with an approved Request to Drive Agency Vehicle To Out of County Residence Form #530 or such operation has been approved in writing by the Sheriff.
- Civilian employees will be familiar with the operation of the police radio and will utilize the radio in an emergency situation to notify the PCO of such emergency.
- Civilian and Sworn Correctional Officer employees who are authorized to utilize Agency vehicles off-duty or to commute to or from work must comply with Internal Revenue Service requirements to report such use as income. The reporting of this income shall be coordinated through the Commander/ Director, Administrative Services.

Violation of any part of this policy may subject the employee to disciplinary action.

#### **4-219.6 OFF-DUTY VEHICLE USE DRESS CODE**

Employees operating Agency vehicles off-duty, with the exception of undercover or covert vehicles, will be attired and groomed in a fashion which does not bring discredit upon the Office of the Sheriff. Clothing and footwear shall be functional; i.e., it is of such a design as to allow the employee to perform the duties required of his position, the same as if the employee were in an on-duty status. This prohibits the wearing of flip flops, sandal or high-heel type shoes and the wearing of shirts or "T" shirts which have no sleeves or are designed with just shoulder straps of any width, or a complete lack of over-the-shoulder material. No clothing which makes a social, political, racial, religious, or life-style statement of any kind, in words or in art form, will be worn. Any baseball type hat shall be worn with the



Administrative and Operational Manual

September 12, 2022

visor portion facing directly forward. Wearing the hat with the visor off to one side or to the back is prohibited.

Clothing will match the weather in order that the employee will be prepared to withstand the current conditions outside the vehicle for a prolonged period of time. Employees will be prepared to fulfill their on-duty responsibilities whenever they arise while the employee is operating an Agency vehicle off-duty.

#### 4-219.7 PERSONS TO BE ALLOWED IN SHERIFF'S VEHICLES

The use and access to Sheriff's vehicles is enabled and limited as follows:

- Sheriff's Office employees may routinely operate vehicles as necessary for the official performance of their duties, so long as the operating employee possesses the proper license for the vehicle operated and the vehicle is operated in accordance with Maryland Vehicle Law and the provisions of this Manual.
- In on-duty operations, employees may transport such persons as may be necessary to fulfill the work responsibility of the employee. In these cases the PCO will be advised the vehicle is in a transport condition. If it is appropriate, because of liability considerations, the location of the start of the transport and the beginning mileage of the transport will be announced to the PCO. The PCO in these cases will acknowledge the mileage report with a time check. In such cases the ending mileage and the location will be announced and acknowledged by a time check from the PCO. In all cases the transporting employee will announce the completion of a transport to the PCO.
- No person, who is not an employee of the Sheriff, or a mechanic who must test drive a vehicle as a part of authorized repair work, or has been specifically authorized by the Sheriff, will be allowed to operate Agency vehicles.
- Off-duty travel in a Sheriff's Office vehicle will be permitted for members of the employee's immediate family and Agency personnel. In addition, other passengers may be permitted subject to the written approval of the employee's commander/ director. Immediate family, for the purpose of this section, includes the employee's spouse, children and parents.
- Insurance coverage for passengers is limited; i.e., passenger injuries sustained as a result of employee driver error may become the financial responsibility of the employee driver. Employees should consider this factor when deciding who they will permit to be a passenger during off-duty use of the vehicle.

#### 4-219.8 ANIMALS IN VEHICLES

Employees will not transport animals within a Sheriff's Office or County vehicle unless the animal is a police K-9, Agency Comfort Canine or the animal is being transported for medical treatment.

#### 4-219.9 RESPONSE TO INCIDENTS WHILE PASSENGERS ARE ABOARD

Employees will take all possible steps to ensure the safety of persons transported in Agency vehicles. If there is a need to respond priority to a scene or there is probable danger for passengers at a scene, the employee will disembark passengers at a safe location prior to responding. Officers will consider the level of threat to passengers before initiating any law enforcement activities while accompanied by passengers.

When disembarking passengers, the employee will consider the safety and well-being of those passengers as a result of being left at a particular location. If employees disembark passengers in order to attend to a law enforcement function, they will advise the PCO of the location of passengers and the PCO will attempt to provide for their pick up if the disembarking employee is engaged in work activities for an extended period of time.



Administrative and Operational Manual

September 12, 2022

---

#### 4-219.10 SUPERVISORY RESPONSIBILITIES

All supervisory personnel will be continually aware of employees operating Agency vehicles in their presence. Any supervisor who observes an employee operating an Agency vehicle in a discourteous manner or a manner that is not in compliance with law or the provisions of this Manual will take corrective action.

Corrective action may take the form of:

- an immediate counseling (may be documented on the Employee Conference Form #180 using the procedures outlined in this Manual for that form) of the employee and recommendation for corrective action to be taken by the employee; and/or
- an informal or formal notification of the employee's supervisor concerning the circumstances surrounding the operation of the vehicle; and/or
- the placing of formal charges against the employee for violation of Agency rules or law; and/or
- in emergency circumstances, the retrieval of the vehicle from the employee's possession with immediate notification to the Sheriff of the circumstances requiring the retrieval.

Supervisors will continually conduct, on a regular basis, a review of the provisions of this Manual governing the use of Agency vehicles. Supervisors will see that changes in these policies, or the vehicle laws which come to their attention, are brought to the attention of employees whom they supervise in a timely manner. Training sessions, conducted in accordance with this section, will:

- be recorded by the supervisor on a Report of Training Form #182 and submitted to the Commander, Training Division;
- have the record of such training maintained by the Commander, Training Division in a file established for such training;
- have a list of the employees attending, the subject matter of the training session, any discussion items or problems discovered and how they were addressed, maintained in the Training file;
- require the Commander, Training Division to address such subject matter which may be of interest to the Agency as a whole in the construction of Agency-wide training programs;
- require the file to contain a record of the date and length of the training session.

Supervisors will regularly inspect vehicles assigned to employees under their command and will be continually aware of the general condition of these vehicles. As a part of this inspection, the supervisor will operate the vehicle. These inspections shall be documented on the Monthly Personnel & Vehicle Inspection Form #75. Supervisors who are aware of the potential loss of resources represented by an employee who fails to properly care for, service or maintain a vehicle assigned to the employee, will notify the Sheriff through the chain of command.

In cases where the employee will be absent from work for a period exceeding 30 calendar days, the division commander/ director of the employee may make arrangements through the Commander, Property Management, to place the vehicle in a pool status or in more permanent storage. This will be accomplished by removing any of the assigned employee's personal equipment.

#### 4-219.11 PARKING REGULATIONS



**Administrative and Operational Manual**

**September 12, 2022**

Employees operating Agency vehicles will observe all parking regulations, except in emergency circumstances requiring deviation. In these emergency instances, the employee will:

- park the vehicle in the least hazardous location possible with consideration for traffic and other emergency vehicle access to a scene; and
- place the vehicle's parking flashers on; and
- activate the vehicle's emergency lights if the hazards of the location suggest such activation; and
- ensure the security of the vehicle by locking it if it is to be unattended.
- do not leave the vehicle unattended and running for any length of time. (Example: while taking report inside a business, vehicle will be secured and turned off.)

In general, if the vehicle is to be parked and left unattended, the employee should secure the contents of the vehicle to the degree possible by placing valuable or easily stolen objects in the trunk.

#### **4-219.12 VEHICLE ESCORTS**

The operation of an Agency vehicle in its emergency response mode to escort another vehicle is prohibited. Escorts of other vehicles in a non-emergency response mode may be made with due consideration for the fact no special exception to the vehicle law is provided to the escorted vehicle by the escort. In a funeral escort for example, the Agency employee must take steps to ensure traffic has seen the escort and will stop or behave in the anticipated manner in response to the escort.

#### **4-219.13 SURVEILLANCE VEHICLES**

A pool of vehicles will be maintained to support the surveillance activities of the Agency. These vehicles will be under the responsibility of the Commander, Criminal Investigations Division. The care and maintenance will be in accordance with policies pertaining to other pool vehicles which are not personally assigned to a particular employee but are assigned to the use of a particular unit of the Agency. The following specific conditions apply to surveillance vehicles:

- surveillance vehicles will be utilized for on- duty assignments only; and
- sworn police officers will not occupy surveillance vehicles while that employee is in uniform; and
- surveillance vehicles will not be used to conduct traffic stops; and
- surveillance vehicles will not be conspicuously parked, such as in reserved parking spaces, at police facilities; and
- criminal arrests and transports will not be made in surveillance vehicles unless dictated by emergency circumstances.

#### **4-220 OPERATION OF AGENCY MOTORCYCLES**

The police motorcycle has long been recognized as an effective tool in law enforcement's effort to provide service to its citizens. Agency motorcycles will be deployed primarily for patrol and selective traffic enforcement duties, with the primary objective of promoting traffic safety. With the approval of the Commander, Special Operations Division,



**Administrative and Operational Manual**

**September 12, 2022**

Agency motorcycles may be used for specialized functions such as parades, escorts or crowd control.

Selected officers assigned to Traffic Operations will use Agency motorcycles as their primary patrol vehicles. Only those officers who have received approved training will be assigned responsibility for an Agency motorcycle. Officers assigned an Agency motorcycle will be responsible for its upkeep and regular maintenance as required for any other issued vehicle. The Traffic Operations Supervisor shall be responsible for the monthly inspection of Agency motorcycles. Motorcycle officers shall wear required safety equipment when operating these vehicles.

Motorcycles will be used only on the day and evening shifts. They will not be used during the midnight or relief shift unless specifically authorized by the Commander, Special Operations Division for a specific purpose. When officers who are assigned Agency motorcycles are prohibited from using them as outlined in this policy, the officers shall use their assigned cars.

### **4-220.1 PROHIBITIONS**

Because of the limitations imposed by the design of motorcycles, some functions of police patrol should not be delegated to officers using these vehicles. The following circumstances, conditions and uses are prohibited:

- motorcycles shall not engage in high-speed pursuit of vehicles, except in the most exigent circumstances, and only until relieved by a patrol vehicle;
- motorcycles shall not be used for any transport function, whether the assigned operator is on-duty or off-duty;
- motorcycles shall not be used during periods of freezing precipitation or when road surfaces contain snow or ice;
- motorcycles shall not be used during periods when fog or smoke significantly limit driving visibility;
- officers riding motorcycles shall not be assigned the investigation of a vehicle crash during periods when it is raining; and
- Commanders and supervisors may expand these prohibitions in cases where they believe a particular use is unduly hazardous.

It is generally expected officers using Agency motorcycles will perform most of the functions other Traffic Operations officers using cars perform.

### **4-220.2 OFF-DUTY USE OF MOTORCYCLES**

Motorcycles may not be used in an off-duty capacity, except for transport to and from a maintenance facility or the periodic exercise of a motorcycle which has not received adequate on-duty use.

When operating an Agency motorcycle the officer must be in uniform, unless prior approval by the Commander of SOD is granted for other clothing to be worn. Shorts are a prohibited garment and shall not be worn while operating an Agency motorcycle.

### **4-222 VEHICLE SERVICE PROCEDURES**

Routine vehicle service requirements shall not interfere with an employee's assigned duties, and shall be performed at any authorized service center. An authorized service center is a vehicle maintenance facility, a garage or a repair facility that specializes in vehicle repair and has been approved for use by the Fleet Manager. No supervisory approval is required for routine service.



Administrative and Operational Manual

September 12, 2022

All oil and transmission changes shall be performed at an authorized service center. Unless otherwise directed by the Fleet Manager, routine oil and oil filter changes and lubrication will be performed every 5,000 miles for all Agency vehicles. Unless otherwise directed by the Fleet Manager, routine transmission service and air filter changes will be performed every 25,000 miles for all Agency vehicles. Vehicle tire rotations will be performed every 10,000 miles for all Agency vehicles. Diesel powered vehicles will follow the guidelines provided with the vehicle. The Fleet Manager shall supply each person responsible for the maintenance of a vehicle with the routine service schedule for that vehicle.

When a vehicle needs service or repair, the employee shall take the vehicle to an authorized service center. Most businesses that service an Agency vehicle submit their bills to the Fleet Manager electronically. Invoices from approved vendors must be submitted to the Accounting Section for payment within 30 days from the date of service. However, if an employee receives a bill at the time of a vehicle repair, the employee shall forward the bill to the Fleet Manager within 72 hours of the service. Along with the invoice, the employee must include or attach the following information, if not already on the invoice:

- Vehicle ID#
- Vehicle tag#
- Vehicle mileage
- Printed employee's name
- Employee's signature authorizing payment

The Fleet Manager will monitor routine vehicle service to ensure compliance.-

#### 4-222.1 VEHICLE REPAIR

Minor repairs, such as bulb replacement, windshield wiper replacement, windshield chip repair, battery replacement and other minor repairs, should be accomplished at Fleet Services. Due to the cost savings of completing these repairs in house, officers should only use an outside vendor for these repairs with the approval of a supervisor.

Major repairs require approval of the Fleet Manager prior to the work being performed. The Commander, Property Management can be contacted in their absence. A listing of all authorized service centers is located on the CCSO Intranet under Property.

Once a vehicle is taken to an authorized service center for repair, excluding oil and transmission service, all decisions regarding the repair or maintenance of the vehicle are made by the Fleet Manager or the Commander, Property Management.

Tire replacement shall be accomplished at an authorized vendor.

If a vehicle is under warranty, the vehicle shall be repaired by an authorized dealer.

#### 4-222.2 VEHICLE EMISSIONS

The State of Maryland requires most vehicles to comply with emissions standards. The Fleet Manager shall issue emissions inspection coupons to the Division Commanders of the assigned employee. The Division Commander shall ensure vehicles under their command are tested in a timely manner.

Employee responsibilities:

- Once an employee receives an emissions coupon, the employee shall have their assigned vehicle





Administrative and Operational Manual

September 12, 2022

tested within 30 days.

- If an employee misplaces an emissions test coupon, the employee shall have their assigned vehicle tested at the employee's time and expense.

### 4-222.3 FUELING PROCEDURES AND CONSUMPTION CONSERVATION

- Fuel shall be obtained from the County supply unless otherwise authorized;
- Fuel obtained from sources other than County supply shall be unleaded fuel not over 87 octane;
- Each Agency vehicle will be assigned a gas key for the County supply tanks located at the La Plata District Station, Waldorf fueling station, Mattawoman Treatment Plant in Mason Springs and Public Facilities on Audie Lane off of Radio Station Road in La Plata;
- Authorized vehicle operators will utilize an issued personal identification number (PIN) to dispense fuel in all Agency vehicles from County operated pumps;
- Receipts for fuel purchases with outside vendors must be submitted to Fleet within 72 hours of the purchase and must include the vehicle ID and tag number;
- Officers shall begin their tour-of-duty with a full tank of fuel. EXCEPTION: Officers may start without a full tank of gasoline; however, they must have adequate fuel to begin a tour-of-duty without immediately refueling;
- The engine should be turned off when gasoline is being dispensed, or when the vehicle is parked and there is no need for power-drawing equipment to be activated;
- Employee operators will refrain from unnecessary acceleration;
- Employee operators will attempt to maintain a constant speed and keep within posted speed limits during normal driving.
- The Agency Facilities Manager is the primary contact for any issues with the County fuel pumps 24/7. The Commander, Property Management will be contacted in his absence.

### 4-222.4 OIL USAGE

Oil needed between regular oil changes is obtained from Fleet Services. Supervisors may approve commercial purchase in emergency situations.

### 4-222.5 VEHICLE EQUIPMENT

The following equipment shall be maintained in assigned vehicles:

- Fire extinguisher
- First aid kit
- Two blankets
- Camera with SD Card
- Tape Measure



Administrative and Operational Manual

September 12, 2022

- Authorized ammunition
- Box of flares (no less than 12)
- Personal protection kit
- Latent fingerprint kit
- Vehicle Lock Out Kit
- TECC Kit

Additional equipment not listed above must be approved by the respective commander / director.

Employees are required to replenish the mandatory vehicle equipment to maintain operational readiness at all times. Following established procedures, mandatory vehicle equipment may be replenished through the Quartermaster by submitting an Agency Loss/Damage Report, Form #310. Or if an item becomes unserviceable through normal wear and at no fault of the officer, the officer shall be issued a replacement item as long as the officer surrenders the non-serviceable item at the time of reissue.

Used fire extinguishers will be turned in to the Quartermaster who will issue a new one. Replacement flares are stocked in designated storage areas at each district station. The administrative sergeants are responsible for ensuring an adequate supply of flares at each district station at all times and will coordinate re-stocking with the Quartermaster. Ammunition shall be replenished at the next firearms qualification or range practice day.

The use of the Monthly Personnel and Vehicle Inspection Form #75 will aid with ensuring vehicles are properly stocked.

#### 4-222.6 OPERATOR-INSTALLED EQUIPMENT

With the addition of computers, video, and other electronic equipment, technology continues to advance, and equipment installed in police vehicles is becoming more complex. This equipment allows employees to access a wide variety of tools in the field and perform tasks that once were possible only at police installations.

Operator installed equipment must be securely positioned to remain in place during high-speed vehicle maneuvers and to protect the operator during a collision. The following equipment may be installed without prior approval:

- Equipment / report form "caddies," pursuit cases may be used if securely positioned to remain in place during high-speed vehicle maneuvers and during a collision;
- Floor mats which do not interfere with the operation of the vehicle controls;
- Cool seats or seat covers that are the same color as the seats which do not create instability for the driver in maintaining his position behind the steering wheel;
- Steering wheel covers which coordinate in color and appearance with the vehicle interior and do not create a hazard to the operation of the vehicle;
- Beverage cup holders which are placed so as not to interfere with the operation of the vehicle;
- Clear plastic door edge moldings;
- Auxiliary lights that are "plug and play" into the vehicle's factory or Agency installed power outlet. These auxiliary lights may be blue, red or white and shall not be hard wired into the vehicle electrical system;



Administrative and Operational Manual

September 12, 2022

- RADAR unit approved by the Agency.

## 4-223 MONTHLY MILEAGE REPORT

Employees assigned or responsible for Agency vehicles will track the miles driven on those vehicles each month. First-line supervisors will be responsible for collecting their subordinates' mileage information and submitting it, along with their own, to Fleet, using the online link.

A Vehicle Maintenance / Mileage Worksheet Form #961 is available online to assist employees assigned a vehicle with tracking vehicle maintenance and mileage. This is for the employee's use only and is not submitted.

Other individual employees assigned or responsible for an Agency vehicle will submit their mileage using the online link.

Vehicle mileage information must be submitted to Fleet Management by the 5<sup>th</sup> of each month. Mileage information for the month of June shall be submitted on or before the first of July, instead of the fifth of the month, due to the need to close out the fiscal year budget which ends June 30 each year.

### 4-223.1 MONTHLY VEHICLE INSPECTIONS

Vehicle inspections shall be conducted monthly by supervisors or their designees. Each subordinate's vehicle shall be inspected individually, including sworn, civilian, or pool (spare) vehicles in the supervisor's command and control. The results of that inspection shall be recorded on the Monthly Personnel & Vehicle Inspection Form #75, submitted electronically to the respective commander / director or his designee for review, and then forwarded to the Standards & Inspections Officer for disposition. Supervisors are reminded the condition of the vehicles in their charge is ultimately their responsibility.

Minor discrepancies discovered during the inspection shall be corrected immediately and the correction noted by the supervisor or his designee before forwarding the Form #75. In the case of discrepancies which cannot be immediately corrected, the supervisor shall note the correction on the next Form #75 indicating a reason for the continuing discrepancy and the actions taken by the supervisor to address it.

### 4-223.2 SPEEDOMETER CERTIFICATION

Division commanders / directors shall ensure vehicles used by personnel under their command in the enforcement of speed limit laws have the vehicle speedometer certified in order to provide valid evidence in court of the speed indicated on the speedometer. This certification shall be accomplished for each vehicle at the speeds of 35, 45, 55, 65 and 75 miles per hour. A vehicle speedometer shall be certified as soon as possible after the vehicle is acquired by the Agency, and before it is put into service in the enforcement of speed limit laws. The vehicle shall be recertified at least every four months thereafter, or whenever the vehicle experiences any maintenance or modification of its drive train or its speedometer.

All speedometer certifications shall be accomplished by an approved RADAR operator of this Agency who will be responsible to appear in court as necessary to testify to the validity of the certification process. Certification shall occur only on roadways having a posted speed limit of at least 50 miles per hour. The road surface shall be relatively level and straight, allowing for the observation of any possible conflicting traffic. The roadway will be dry and present no special hazards. The certification process shall be conducted in daylight hours when traffic is light.

The results of the certification process shall be recorded on the Speedometer Accuracy Certification Record Form



Administrative and Operational Manual

September 12, 2022

#111. This card shall be maintained in the vehicle glove box except when it is removed to present in court.

### 4-223.3 MANDATORY VEHICLE INSPECTION

All Agency vehicles shall be inspected when they have accumulated 80,000 miles of operation. Follow-up inspections shall be performed at 125,000 miles and every 25,000 miles thereafter. This inspection shall be accomplished by a Maryland Certified Inspection Station. The Fleet Manager shall be contacted by the employee assigned the vehicle when the inspection is due and will coordinate inspections with the inspection station. It is the duty of the employee assigned the vehicle to ensure that the inspections are scheduled. The results of the inspection shall be submitted to the Fleet Manager.

### 4-224 UNASSIGNED (POOL) VEHICLES

Some Agency vehicles will be assigned to a division / component for those employees who need the temporary use of a vehicle. The commander / director of the division where these vehicles are assigned will delegate an employee to be responsible for the use and maintenance of these vehicles.

Employees who are assigned to care for a pool vehicle will be responsible for the record keeping for the pool vehicle, including maintenance, repairs, etc., and shall ensure the vehicle receives proper maintenance, is kept clean, is fueled, and is otherwise ready for use. All original bills, statements, and other records of repair for items addressed by this section shall be forwarded within 72 hours to the Fleet Manager upon completion of the repair. The invoice shall include the information detailed in the vehicle service policy.

Any employee who uses one of these vehicles will do so only with permission of a supervisor and will see that the vehicle is properly fueled and the engine oil is at the correct level. The employee using the vehicle will remove all trash and belongings from the vehicle when the use of the vehicle is completed.

Documentation or record keeping such as sign-out logs or usage logs will be kept by the commander / director responsible for each vehicle. The Unassigned Vehicle Log Form #76 is available online for this purpose. Each commander / director assigned pool vehicles is responsible for maintaining knowledge of who was operating Agency pool vehicles at any given time.

Vehicle inspections of all pool (spare) vehicles shall be conducted monthly by supervisors or their designees. The results of that inspection shall be recorded on the Monthly Personnel & Vehicle Inspection Form #75 submitted electronically to the respective commander / director or his designee for review, and then forwarded to the Standards & Inspections Officer for disposition. Supervisors are reminded the condition of the vehicles in their charge is ultimately their responsibility.

Only the monthly mileage usage, based on listed procedures, is required to be submitted to Fleet.

No person may smoke or use tobacco products of any kind while occupying an Agency-owned vehicle.

### 4-225 DIGITAL MOBILE VIDEO/ AUDIO RECORDERS (DMVR)

This policy is established to regulate the use of digital mobile video/ audio recorders (DMVR) in Agency vehicles. The Agency has adopted the use of DMVRs for purposes that include, but are not limited to:

- enhancing officer safety;
- collecting evidence;



Administrative and Operational Manual

September 12, 2022

- providing a supplement to personal testimony in court by recording actions, conditions and statements which can be used to aid in the prosecution of those who violate traffic and criminal laws;
- allowing for the viewing of events as they actually occurred and providing corroboration of officers' actions/ testimony;
- providing material to be used in performance evaluations; and
- providing an effective aid for training.

It is the policy of the Charles County Sheriff's Office that officers will use the digital mobile video/ audio recording (DMVR) equipment to record contacts that occur between officers and the public. To maximize the utility of this equipment, officers will follow the procedures for DMVR equipment use as set forth in this policy. All officers will receive initial training on the operation and utilization of the DMVR equipment, prior to the completion of their initial field training.

The U.S. Supreme Court has held an officer has the right to observe what the officer can see if the officer has the legal right to be present (plain view). So it follows, if an officer has the right to observe, then he has the right to photograph and/or videotape. The recording is made by "one party consent."

The Annotated Code of the Public General Laws of Maryland Courts and Judicial Proceedings (CJ ' ' 4, 10-402) relating to wiretapping and electronic surveillance states AIt is lawful under this subtitle for a law enforcement officer in the course of the officer's regular duty to intercept an oral communication if:

- the law enforcement officer initially lawfully detained a vehicle during a criminal investigation or for a traffic violation;
- the law enforcement officer is a party to the oral communication;
- the law enforcement officer has been identified as a law enforcement officer to the other parties to the oral communication prior to any interception;
- the law enforcement officer informs all other parties to the communication of the interception at the beginning of communication; and
- the oral interception is being made as part of a videotape recording.

#### **4-225.1 DMVR EQUIPMENT INSTALLATION, MAINTENANCE AND ROUTINE CARE**

Fleet Management shall be responsible for the management of all installation, repairs or modifications of DMVR equipment. Only digital mobile video / audio recording equipment acquired by the Charles County Sheriff's Office will be installed in Agency vehicles.

The Information Technology Division (ITD) shall be responsible for the management of the DMVR system software and maintenance of download stations and storage servers.

The Records Management Section (RMS) shall be responsible for the administration of requests for video footage, distribution and the archiving of all copies of DMVR system recordings.

Routine care and maintenance of DMVR equipment installed in any Agency vehicle is the responsibility of the officer assigned that vehicle. Equipment will be maintained in accordance with this policy and manufacturer recommendations. Only authorized technicians will install, repair and/or modify DMVR equipment.

At the beginning of each tour of duty, officers will open the Frontend program on their docked agency laptop computer. This ensures the officer's ID is registered on the incidents recorded on the DMVR during their work day. This is especially important when an officer operates a spare vehicle, which may have different operators from day to day.



Administrative and Operational Manual

September 12, 2022

Prior to and throughout each shift, officers will ensure all components of the DMVR equipment are working satisfactorily and will immediately bring any problems to the attention of a supervisor.

Prior to and periodically during a tour of duty, cameras should be checked for proper adjustment (including the zoom adjustment), mounting security and secure connection of all wires and cables.

To prevent damage, only approved products will be utilized to clean the camera lens.

Optional microphones and cords can be fragile. They should be securely concealed within the uniform shirt.

Transmitters shall be worn as designed and intended by the manufacturer. A comfortable and convenient location on the Sam Browne belt is recommended, and the transmitters should be protected as much as is practical.

If hot or cold weather conditions adversely affect the operation of the equipment, a supervisor will be notified and arrangements for repairs made through the Quartermaster.

#### 4-225.2 DMVR EQUIPMENT FUNCTIONS AND USE

**Software:** Arbitrator 360 is the current operating system utilized by the DMVR system. The two programs used to access Arbitrator are Frontend and Backend. Frontend is accessed during the initial recording stage of incidents prior to uploading the footage to the server. Backend is used to search and view incidents after they are uploaded to the server.

**Recorder:** Compression software with video authentication and embedded time stamp eliminates any possible attempts to alter, change, or eliminate recordings. The in-vehicle hard drive saves all recordings for upload to the server.

The recorder hard drive door will be locked at all times. The recorder can be activated in several ways:

- manually: by pressing the “record” button on the camera;
- manually: by pressing the “record” button on the Frontend program;
- automatically: by turning on the vehicle emergency lights;
- automatically: by opening the rear passenger side door;
- automatically: by excessive speed;
- automatically: when the vehicle is involved in a crash; or
- remotely: by turning on the wireless transceiver/microphone.

Regardless of how the recorder is activated, it can be turned off manually, by pressing and holding the red button on the camera for five seconds until the “record” light goes off or by pressing the “stop” button in the Frontend program.

**Transceiver/Body Microphone:** The remote transceiver contains a microphone. An optional microphone can be attached to the transceiver and worn on the uniform to enhance audio recording. The optional remote microphone shall be worn concealed within the uniform shirt. Officers will ensure the transceiver is fully charged prior to each shift. Officers shall carry their remote transceivers in their cruisers and use them during off-duty incidents the same as for on-duty incidents.



Administrative and Operational Manual

September 12, 2022

Remote transceivers will operate from a Lithium Ion battery pack with between eight (8) to twelve (12) hours of continuous operation on a single charge.

**Back-up System Battery:** The back-up system battery will be replaced by fleet technicians every two years.

**Vehicle Microphone:** The internal microphone allows audio recording of normal speech within the interior of the vehicle, independent of the remote audio transmitters. The interior microphone actively records whenever the system is in the record mode.

**Cameras:** The mounting device for the front camera allows for manual adjustment vertically and laterally. Officers shall ensure cameras are positioned properly for each incident where a recording is being made. The back-seat camera is a micro compact with wide angle and is pre-focused on the back seat area.

The front camera lens has the capability of recording a properly mounted license plate at a distance of 25 feet or less, allowing it to be easily read during in-vehicle playback without the need for electronic enhancement. This is accomplished through the use of an operator initiated automatic zoom feature that momentarily limits the field of view and then returns to the preset (normal) view.

### 4-225.3 RECORDING GUIDELINES

Once recording of an incident has been initiated, the recording of both audio and video should continue until termination of the incident. If for any reason recording is discontinued prior to the conclusion of an incident, the reason(s) should be documented on the recording.

At the beginning of each traffic stop or public contact the officer will notify all involved individuals they are being recorded. Example:

- “Good morning, I am Officer Smith of the Charles County Sheriff’s Office. I am advising you are being audibly and visually recorded. You were stopped for exceeding the maximum posted speed limit.”

Officers will also notify any assisting officers they are being recorded by using the caution code “AV” (audio visual).

Officers are not required to discontinue recording of an incident at the request of anyone other than a superior officer.

Officers will note in their arrest and related reports when recordings are made. In the event an incident which should have been recorded is not captured on the DMVR, the officer will note on his report the reason a recording was not made. In vehicles equipped with in-car cameras, events to be recorded include, but are not limited to:

- emergency responses;
- traffic stops (beginning to end);
- vehicle pursuits;
- observation of DWI suspects prior to stop, during performance of field sobriety tests, and during transport if arrested, until removal from vehicle;
- transport of all prisoners until removal from vehicle;
- transport of any persons in an Agency vehicle for official Agency business;
- vehicle searches and inventories;



**Administrative and Operational Manual**

**September 12, 2022**

- any confrontational contact with a citizen / violator, including all acts of hostility and violence; and
- any other incident the officer feels may become an issue of some importance at a later date. If any doubt exists, record it;
- All agency motor vehicle crashes.

Any time the recorder is on while the officer is outside the vehicle, the microphone shall also be activated. The officer will narrate those things which are outside of the camera's view.

If the event is being recorded and more than one unit equipped with DMVR equipment is present, each officer should record both video and audio.

Once recording is started, officers will not cease audio and video recording until the termination of the traffic stop or other citizen contact. Officers will not attempt to erase, reuse, tamper with, or attempt to modify recordings in any way. The recorder may be turned off in situations such as:

- funeral details;
- routine traffic direction;
- work zone projects; or
- emergency scenes when the DMVR equipment is not otherwise being used.

Recordings can be classified by the officer at the time the recording is stopped through the Frontend program. (For example, traffic stop, test, evidence, other, etc). The classification can be changed by any authorized user.

#### **4-225.4 REVIEW, RETENTION, AND STORAGE OF RECORDINGS**

The Arbitrator 360 system completes an automatic upload of recordings contained on each system when the officer's vehicle parks at one of the following agency facilities: District 1 station, District 2 station, District 3 station, and the CCSO Annex. Recordings will be stored, duplicated, distributed or erased only in compliance with this policy. Records Management and ITD are responsible for the management, storage and security of all recordings.

The DMVR system automatically erases recordings from the DMVR server after thirteen (13) months, unless a request for retention is received.

A request for retention shall be made for recordings containing material of essential or evidentiary value, such as arrests, assaults, physical or verbal confrontations or incidents which may result in a citizen's complaint. The request for retention will be completed via a Form #879 Request for In-Car DVD and submitted to the Records Management Section.

Supervisors of those officers assigned DMVR equipment shall review, on at least a quarterly basis, randomly selected recordings for the purpose of assisting them in the preparation of performance ratings.

Recordings containing material deemed useful by the Commander, Training Division may be used for training purposes. Officers, supervisors and commanders are encouraged to forward information describing recorded incidents which may be beneficial in Agency training via a memorandum, through their respective chain of command, to the Commander, Training Division.

#### **4-225.5 COPYING RECORDINGS**

Requests for copies of a recording will be handled in accordance with Maryland Public Information Act (MPIA)





Administrative and Operational Manual

September 12, 2022

procedures.

#### 4-225.5.1 IN-AGENCY REQUEST FOR COPY OF A RECORDING

Copies of Agency recording footage will be used only for official Agency purposes. Unless requested by a member of the executive command staff, OPR or the Office of General Counsel, a request for copy must be submitted on Form #879 Request for In-Car DVD. Requests for copies of a recording will be made at least 14 days in advance of the anticipated need.

#### 4-226 PATROL CHECKS

Patrol checks provide a valuable service to the citizens and business owners of Charles County. These checks keep officers up to date for where incidents have occurred or where citizens feel vulnerable. Patrol checks also allow citizens and business owners to have positive encounters with police officers.

Requests for patrol checks may be initiated by either a police officer or a citizen / business owner for various reasons, to include:

- past criminal history, high incidents of crime;
- residents away from the residence for an extended period of time (one month or longer);
- valuable resources left on location with no security available.

Requests will be made by the completion of a Special Patrol Check Request Form #905 for a specific location or a geographical area. The request must be signed by the property owner or representative who has legal authority (business manager or police officer) and submitted to the commander of that district. If an unusual situation occurs (RRE, sexual assault) and the district commander is unavailable, then a shift commander will be contacted for an immediate review of the request. The commander will then either approve or deny the request and determine the length of time the patrol check should remain in effect (if approved). If the request is denied, the commander will send a written notice to the requestor advising why the request was denied. Approved requests will be forwarded to a district police station technician who will enter the patrol check into the CAD / RMS system and record the patrol check number onto the request form. The original request will be kept on file at the district station for a period of one (1) year after the patrol check has been activated.

#### 4-226.1 SUPERVISOR'S RESPONSIBILITIES

Supervisors are responsible for making sure their squads are aware of current / active patrol checks. Prior to the start of each shift, the oncoming supervisor will print a copy of the current patrol checks for his assigned district from the CAD system and distribute a copy to each officer assigned to his squad. Patrol officers will attempt to make at least one check per shift of any patrol check in their assigned beat and notify Communications each time a check was completed.

#### 4-227 ARREST WARRANTS / CRIMINAL CHARGING DOCUMENTS - FILING AND ACCESS

All arrest warrants / criminal charging documents will be processed, entered into all required computer systems and made ready for service by Judicial Services personnel. All warrants and criminal charging documents are available 24 hours a day.

All original arrest warrants / criminal charging documents not in the custody of a sworn officer for service will be



**Administrative and Operational Manual**

**September 12, 2022**

---

kept within the Judicial Services Section at the La Plata District Station. The warrant file cabinets within Judicial Services will be in a locked room when Judicial Services personnel are not present. After hours access to the warrant file cabinets will be granted to Agency employees with a legitimate reason for accessing the documents in the course of their usual responsibilities.

## **4-228 NARCAN (NALOXONE)**

Narcan (Naloxone) is an opiate antidote. This prescription medicine blocks the effects of opiates, which include heroin, morphine, codeine, OxyContin, methadone, Percodan, and Vicodin. Narcan is intended to temporarily reverse the effects of an opiate overdose, including restoring breathing that has stopped or slowed down. It cannot be used to make a person high, and will not have any effect on a person who has not taken opiates. CCSO will utilize and administer the nasal form of this drug only.

This policy establishes guidelines and procedures governing the utilization of the nasal Narcan administered by officers. The objective of administering nasal Narcan is to treat opioid overdoses and minimize overdose deaths caused by opioids.

Only officers trained in the use of nasal Narcan are authorized to administer nasal Narcan in the field.

### **4-228.1 TRAINING**

The Training Division will conduct training by use of a video provided by Narcan's manufacturer along with a review of CCSO policy and reporting requirements. The Training Division shall maintain the training records. Retraining shall be conducted every two years in conjunction with CPR recertification and anytime the method of administering the nasal form of Narcan changes.

### **4-228.2 ISSUANCE, MAINTENANCE, AND REPLACEMENT**

Nasal Narcan kits will be dispensed through the Training Division. The Training Division will handle the issuance and replacement of the kits.

Officers authorized to use nasal Narcan kits are responsible for the safe storage and inspection of the kit prior to each shift. A damaged or used nasal Narcan kit will be reported directly to the Training Division, which will replace or replenish the kit as soon as practicable. Lost kits will be reported on the Loss/Damage Report Form 310.

### **4-228.3 INDICATIONS AND USE**

Authorized officers shall utilize nasal Narcan on subjects believed to be suffering symptoms, as outlined in training, from a potentially lethal opioid overdose.

Officers shall follow the protocols outlined in their nasal Narcan training, to include universal precautions against pathogens, performing patient assessment to determine unresponsiveness, absence of breathing and/or pulse.

Officers will update Communications that the patient is in a potential overdose state. Communications personnel will promptly notify EMS and a paramedic unit.

### **4-228.4 REPORTING REQUIREMENTS**

Upon completing a medical assist with nasal Narcan use, the officer shall complete an incident report detailing the



Administrative and Operational Manual

September 12, 2022

nature of the incident, the care the patient received, the fact that nasal Narcan was deployed, and whether the use was successful.

The incident report will be forwarded through the chain of command to the Records Section, which will forward a copy to DES and the Health Department for their documentation purposes.

By the fifth (5th) of each month, the Commander, Homeland Security will provide to DES and the Health Department the statistics of Narcan use for the prior month.

## **4-229      EXCITED DELIRIUM / SUDDEN IN-CUSTODY DEATH / MEDICAL EMERGENCY**

The United States' Death in Custody Reporting Act defines an in-custody death as: the death of any person who is detained, under arrest, in the process of arrest, is en route to be incarcerated, or is incarcerated at a municipal or county jail, state prison, or other local or state correctional facility (including juvenile facility).

Law enforcement officers periodically come into contact with individuals exhibiting unusual behavior. This behavior is often a result of alcohol intoxication, the influence of drugs, mental illness, uncontrolled anger, or a combination of these factors. However, in some cases unusual behavior may be associated with a serious medical condition often referred to as excited delirium, which in some instances may be fatal. Some experts believe that intense physical exertion, such as when a subject violently resists arrest for prolonged periods, may increase the risk of sudden death. Some experts also believe that rapid and appropriate medical intervention may reduce the possibility of a fatal outcome in such cases.

This policy is intended to complement the training provided by the Charles County Sheriff's Office on the management of subjects with excited delirium and to provide guidance and a plan of action for officers to deal with persons suffering from excited delirium.

### **4-229.1      RECOGNIZING EXCITED DELIRIUM**

Law enforcement officers must be aware of behavior signs that are consistent with excited delirium, but it is not incumbent on them to differentiate true excited delirium from other behaviors that mimic it. When an officer reasonably believes an individual may be experiencing excited delirium, the individual is to be treated as if he is in a medical crisis and will require medical attention. The individual must receive medical attention regardless of whether the subject is also suspected of being under the influence of drugs and/or alcohol.

#### **Four Phases of Excited Delirium:**

- High Fever / Hyperthermia (may not always be present).
- Delirium with agitation (acute onset).
- Respiratory arrest (distress often during / after struggle).
- Cardiac arrest (often during / after restraint).

When someone develops excited delirium, his ability to focus, sustain, or shift attention is impaired, and he is easily distracted. The person's speech may be loud, rambling and incoherent, and it may be difficult or impossible to engage the person in conversation. The person may also be disoriented in regards to time, location, and purpose. He may become delusional or experience hallucinations. Due to an elevated body temperature, many of these individuals remove one or more items of clothing, and may even be completely naked, while sweating profusely. They appear to have extraordinary strength and often seem insensitive to pain. Violence towards objects, especially shiny objects, like lights, mirrors and glass, is a peculiar phenomenon that often accompanies excited delirium.



Administrative and Operational Manual

September 12, 2022

**Signs of Excited Delirium**

**Agitation/excitement**

**Paranoia/Fear**

**Aggressiveness**

**Rage**

**Confusion**

**Shouting**

**Sweating/disrobing**

**Increased activity level**

**Hyperthermia**

**Loud, rambling, incomprehensible or incoherent speech**

**Violence toward objects, especially shiny objects, like glass and mirrors**

**Violence towards others**

**Superhuman strength and endurance**

**Sudden calmness may be ominous, as it often precedes death**

Many reports of in-

custody deaths attributed to excited delirium describe sudden calmness just prior to the person's unexpected demise.

**Persons at Risk:**

- 91%-99% male.
- 31-45 years of age (generally).
- Person usually involved in a struggle.
- Geographic location not a factor.
- Death usually follows bizarre behavior episode, and/or use of illegal drugs or prescription medications.

**4-229.2 INCIDENT MANAGEMENT**

Once Communications personnel or an officer concludes that an individual may be in an excited delirium state, the incident shall, in addition to whatever other law enforcement response may be required under the circumstances, including the use of reasonable force, be managed as a medical emergency.

**4-229.3 COMMUNICATIONS ROLE**

Communications personnel may be the first to recognize a case of excited delirium, based upon information provided by the reporting party, background noises that can be heard during the call, or knowledge of the subject's past behavior from previous encounters with the law. If a call taker or Police Communications Officer (PCO) reasonably believes that the person causing the disturbance may be in an excited delirium state, multiple officers and a supervisor will be dispatched to the scene. A paramedic unit will be requested immediately. The PCO will inform responding officers when paramedics are en route and request where they want them to stage.

**4-229.4 OFFICER'S ROLE**

If an officer responds to an incident and concludes that an individual may be in an excited delirium state, the officer shall, as soon as practical, request additional officers and EMS to respond, if they were not initially dispatched to



## Administrative and Operational Manual

September 12, 2022

the incident. If the subject involved or others at the scene pose a potential threat, the officer shall designate a nearby safe location for EMS personnel to stage until the scene is secure. If the person to be taken into custody is combative or otherwise poses an immediate threat to the physical safety of officers, other persons, or self, officers shall employ that amount of force that is reasonable and necessary to protect themselves and others at the scene and to take the person into custody.

If the person appears to be unarmed and does not appear to pose an immediate threat, officers shall, if practical, contain the subject while maintaining a safe distance and remove others from the immediate area. In this situation, the officers' objective is to gain the person's voluntary cooperation. If the officers determine it is appropriate to take the person into custody, one or more of the following tactics may be helpful in gaining the person's cooperation:

- Attempt to "talk the person down." Ideally, only one officer should engage the person in conversation. However, if the person is unresponsive or non-compliant with the first officer, attempts to communicate should be made by other officers present. The officers should project calmness and confidence and speak in a conversational and non-confrontational manner. The statements should include reassurance and that the officer is trying to help the person. Whenever possible, determine if the person can answer simple questions; this will give the officers at the scene an idea of the level of coherence of the person. Officers should also turn down their radios.
- Remember that the person's mind may be racing, or he may be delusional and/or suffering from hallucinations, so statements and questions may need to be repeated several times. The person may also be fearful and extremely confused based on their psychological state so officers should be patient. If the subject is contained and does not appear to pose an immediate threat, there is no rush. It may take some time for the subject to calm down.
- Attempt to have the individual sit down, which may have a calming effect.
- To the extent officer safety allows, refrain from maintaining constant eye contact, as this may be interpreted as threatening.
- If a family member or another person who has a rapport with the individual can safely participate, enlist his / her assistance in attempting to gain the individual's cooperation.

Once the subject is in custody and the scene is safe, paramedics shall be called in to assist with possible sedation and monitoring of the subject. Only paramedics who are authorized can chemically sedate the individual. Some individuals believed to be in an excited delirium state have gone into cardiac arrest shortly after a struggle ended. As a result, the person's breathing shall be monitored at all times and the person's position adjusted so as to maximize the person's ability to breathe (e.g., avoid lying on stomach and/or exerting excessive downward pressure on the upper torso). The person is to then be transported to a hospital emergency department for evaluation and treatment.

#### 4-229.5 REPORTING AND INVESTIGATION

Where a person suspected of being in a state of excited delirium is dealt with or taken into custody without resistance or injury, the appropriate report(s) will be completed. In all other cases where there is an altercation or injury, officers must thoroughly document the handling of the incident. This is especially true when a death takes place. When any in-custody death occurs, CID and IA shall be immediately notified. The reporting officers at the scene shall be as specific as possible when documenting the incident. Information may include, but is not limited to:

- Information received from Communications while en route to the scene;
- A description of what was observed upon arrival at the scene;



Administrative and Operational Manual

September 12, 2022

- 
- A description of the person's behavior and appearance:
    - Naked or removing clothing;
    - Sweating profusely;
    - Yelling, screaming or incoherent;
    - Hallucinating;
    - Attacking bright shiny objects or lights.
  - A description of the attempted and actual communication between the person and others at the scene;
  - A description of any force used for controlling the person and whether the force was effective or had to be escalated based on the person's response;
  - A description of how the person was restrained;
  - A description of the resistance offered during the attempt to control and/or restrain the person;
  - A description of how the person was positioned after being restrained;
  - A description of how the person was transported (i.e., by ambulance, by vehicle, seat belt and shoulder harness use, positioning of the person);
  - A description of the person's behavior during transport;
  - A description of how the person was monitored during transport, and by whom;
  - Where the person was transported and whether for processing, medical treatment, or emergency commitment;
  - List of witnesses who observed the event;
  - A description of any injuries to other persons at the scene;
  - List of other officers, fire, or EMS personnel present at the scene;
  - If applicable, a listing of any medical assistance or medication administered by paramedics at the scene; and
  - The results of a request of paramedics to obtain and record the body temperature of the person if deceased.

Attention to details may help medical examiners in determining the cause and manner of death. A history of violence or drug-related arrests, mental health treatments, and drug rehabilitation interventions, etc., should be reported.

#### 4-229.6 TRAINING

The Commander, Training Division will ensure that all sworn and correctional employees receive entry level and refresher training on cases of handling excited delirium.



Administrative and Operational Manual

September 12, 2022

---



## Administrative and Operational Manual

September 12, 2022

## 4-231 RESPONSE TO PEOPLE WITH MENTAL ILLNESSES

The Americans with Disabilities Act (ADA) entitles people with mental illnesses or disabilities to the same services and protections that law enforcement agencies provide to anyone else. They may not be excluded from services or otherwise be provided with lesser services or protection than are provided to others.

The ADA calls for law enforcement agencies to make reasonable adjustments and modifications in their policies, practices or procedures on a case-by-case basis. For example, if a person exhibits symptoms of mental illness, expresses that he or she has a mental illness or requests accommodation for a mental illness (such as access to medication), officers and call takers may need to modify routine practices and procedures, take more time or show more sensitivity to extend the services or protections that would be extended to someone else in a similar circumstance.

This policy is intended to address the varying roles officers play in their encounters with people with mental illnesses. As first responders and law enforcers, they may encounter victims, witnesses or suspects who have mental illnesses. As service personnel, they may be called upon to help people obtain psychiatric attention or other needed services. Helping people with mental illnesses and their families obtain the services of mental health organizations, hospitals, clinics, and shelter care facilities has increasingly become a prominent role for police.

No single policy or procedure can address all of the situations in which officers, communications personnel and other Agency personnel may be required to provide assistance to persons who have mental illnesses. This policy is intended to address the most common types of interactions with people who have mental illnesses.

It is the policy of the Charles County Sheriff's Office to ensure a consistently high level of service is provided to all community members. Agency personnel shall afford people who have mental illnesses the same rights, dignity and access to police and other government and community services as are provided to all citizens.

### 4-231.1 DEFINITIONS

In this section, the following words have the meaning indicated.

**Mental illness** – Any of various conditions characterized by impairment of an individual's normal cognitive, emotional, or behavioral functioning, and caused by social, psychological, biochemical, genetic, or other factors, such as infection or head trauma.

**Community Behavioral Health Liaison (CBHL)** – An individual who is a licensed clinical social worker or counselor who conducts follow up care to persons who have been identified by law enforcement as people who have mental, behavioral or addiction issues.

**Crisis Intervention Team (CIT) Officer** – An officer who successfully completed Crisis Intervention Team 40 hour Certification Training held by Southern Maryland Regional Crisis Intervention Team or a comparable approved training.

**Americans with Disabilities Act (ADA)** – applies to people who have a physical or mental impairment that substantially limits one or more of their major life activities, including:

- the ability to communicate, hold a job or care for themselves;
- people who have a record of such impairment; or
- people who are regarded as having such impairment.

The term "substantially limits" is not a clinical term; it is a practical term to distinguish between people who have a mild physical or mental impairment and those whose impairment substantially limits one or more major life activities.





Administrative and Operational Manual

September 12, 2022

### 4-231.2 TRAINING

In order to prepare personnel who, during the course of their duties, may have to deal with persons with mental illnesses in an appropriate manner, the Charles County Sheriff's Office shall provide training to Agency personnel. The Agency will provide entry level personnel with training on this subject and will provide refresher training annually.

In addition, certain Agency officers who participate in the Crisis Intervention Team program will receive additional training. The selected officers will receive an additional forty (40) hours of training which emphasizes communication skills, mental illness symptom recognition and best practices for responding to people in crisis. The training also focuses on working with community partners in mental health and treatment services for better outcomes. Upon completion, CIT trained officers will receive additional specialized periodic refresher training.

### 4-231.3 RECOGNIZING CHARACTERISTICS OF MENTAL ILLNESSES

While many people with mental illnesses control symptoms successfully with the use of medications, others who do not have access to mental health services, fail to take their medications, or do not recognize that they are ill can experience psychiatric difficulties. Officers and other personnel must be prepared to deal with situations involving persons who have mental illnesses and know how to respond to these situations in an appropriate and sensitive manner.

Symptoms of different mental illnesses may include, but are not limited to:

- loss of memory;
- delusions;
- depression, deep feelings of sadness, hopelessness or uselessness;
- hallucinations;
- manic behavior, accelerated thinking and speaking, or hyperactivity;
- confusion;
- incoherence; and
- extreme paranoia.

The degree to which these symptoms exist varies from person to person according to the type and severity of the mental illness. Many of these symptoms represent internal, emotional states that are not readily observable from a distance, but are noticeable in conversation with the individual. The call taker or officer responding to the scene is not expected to diagnose a mental illness, but to decide on the appropriate response to the individual and situation. Recognizing that symptoms may indicate mental illness will help officers decide on an appropriate response and disposition.

Obtaining relevant information from family members, friends, or others at the scene who know the individual and his or her history, or seeking advice from mental health professionals, can also assist officers in taking the appropriate action. Officers on the scene will also have to determine the severity of the behavior, the potential for change in the behavior, and the potential for danger presented by the individual to themselves or to others.

### 4-231.4 POLICE COMMUNICATIONS OFFICERS RESPONSIBILITIES

The quality of information gathered and shared by call takers and Police Communications Officers (PCOs) can affect the way officers respond to and resolve a call for service. This includes those calls involving persons who may have mental illnesses. Gathering information is critical at all stages in assessing these situations, but is particularly critical at the onset.



**Administrative and Operational Manual**

**September 12, 2022**

When the Agency receives a call concerning the actions or behavior of someone who is suffering from mental illnesses, it is essential that the call taker collect information that will prepare an officer to respond to the scene, such as:

- the nature of the problem behavior;
- events that may have precipitated the person's behavior; and
- the presence of weapons.

A family member, friend or concerned party calling about someone who needs help in accessing mental health may volunteer additional information such as:

- past occurrences of this or other abnormal behaviors;
- past incidents involving injury or harm to the individual or others;
- prior suicide threats;
- reliance on medication or failure to take medication;
- relatives, friends or neighbors available to assist officers; and
- physicians or mental health professionals available to assist officers.

When dispatching calls for service involving people who may have mental illnesses, the PCO should provide all relevant background information to responding officers.

When possible, a Crisis Intervention Team (CIT) officer shall respond to the scene to assist. The call disposition, including reporting requirements, shall remain the responsibility of the assigned investigating officer. Communications personnel will be provided a list containing the names of all current CIT officers. The necessary updates to this list will be made by the CIT Coordinator. The CIT Coordinator is a staff member of the Agency, designated by the Sheriff.

If a CIT officer is not listed on the line-up, Communications shall broadcast for any available CIT officer to respond to the call.

If no CIT officer is available, it shall be up to the discretion of the investigating officer and/or his supervisor to determine if a consult from the CIT Coordinator or their designee is necessary.

#### **4-231.5      RESPONSE TO CALLS FOR SERVICE INVOLVING PEOPLE WITH MENTAL ILLNESSES**

When responding to a call that involves a person who has, or exhibits symptoms of, mental illnesses, officers should obtain as much information as possible to assess and stabilize the situation. In particular, officers should gather information regarding the nature of the problem behavior and/or events that may have precipitated the person's behavior and particularly the presence of weapons.

The following specific guidelines detail how to approach and interact with a person who may have mental illnesses and who may be a crime victim, witness or suspect. These guidelines should be followed in all contacts, whether on the street or during more formal interviews and interrogations. If possible, only one officer should talk to the subject. Officers, while protecting their own safety, the safety of the person with mental illnesses and others at the scene should:

- remain calm, give firm, clear directions and avoid overreacting;
- be helpful and professional;



Administrative and Operational Manual

September 12, 2022

- 
- provide or obtain on-scene emergency aid when treatment of an injury is urgent;
  - check for and follow procedures indicated on medical alert bracelets or necklaces;
  - indicate a willingness to understand and help;
  - speak simply and briefly, and move slowly;
  - remove distractions, upsetting influences and disruptive people from the scene;
  - understand that a rational discussion may not take place;
  - recognize that the person may be overwhelmed by sensations, thoughts, frightening beliefs, sounds ("voices") or the environment;
  - be friendly, patient, accepting and encouraging, but remain firm and professional;
  - be aware that their uniform, gun, handcuffs and nightstick may frighten the person with mental illnesses; attempt to reassure him or her that no harm is intended;
  - recognize and acknowledge that a person's delusional or hallucinatory experience is real to him or her;
  - announce actions before initiating them;
  - gather information from family or bystanders.

While each incident will be different, when dealing with a person who may have mental illnesses, officers should be aware that their own actions may have an adverse effect on the situation. Actions that officers should generally avoid include:

- moving suddenly, giving rapid orders or shouting;
- forcing discussion;
- direct, continuous eye contact;
- touching the person (unless essential to safety);
- crowding the person or moving into his or her zone of comfort;
- expressing anger, impatience or irritation;
- assuming that a person who does not respond cannot hear;
- using inflammatory language, such as "mental" or "mental subject;"
- offering the subject multiple choices which can add to the subject's confusion;
- challenging delusional or hallucinatory statements; and
- misleading the person to believe that officers on the scene think or feel the way the person does.

Once sufficient information has been collected about the nature of the situation, and the situation has been stabilized, there are a range of options officers should consider when selecting an appropriate disposition. These options include the following:

- refer or transport the person for medical attention if he or she is injured or abused;
- outright release;
- release to care of family, caregiver or mental health provider;
- refer or transport to mental health services;
- refer or transport to substance abuse services;



**Administrative and Operational Manual**

**September 12, 2022**

- assist in arranging voluntary admission to a mental health facility, if requested;
- transport for involuntary emergency psychiatric evaluation, if the person's behavior meets the criteria for this action; or
- arrest, if a crime has been committed.

Officers should remember that having a mental illness is not a crime. No individual should be arrested for behavioral manifestations of mental illness that are not criminal in nature. Taking a person who has a mental illness into custody can occur only when:

- the individual has committed a crime;
- the individual presents a danger to the life and safety of the individual or others and meets the state's criteria for involuntary emergency evaluation; or
- in response to a court order or directive of a mental health or medical practitioner who has legal authority to commit a person to a mental health facility.

#### **4-231.6 COMMUNITY RESOURCES**

If a specific community resource (e.g., health department, victim services, crisis hotline, etc.) is needed during interaction with a person with mental illnesses, officers should contact Communications for assistance and referral information.

When an officer comes in contact with a subject they believe may benefit from the services of the Community Behavioral Health Liaison (CBHL), the officer may refer the subject, if the subject consents.

If the subject consents to a CBHL referral, the officer will add notes to the call sheet (regardless of the event classification), ensuring the notes include referral to the CBHL.

Referral to the CBHL is voluntary and the subject's consent should be noted in the call sheet. If the subject does not consent, their information will not be shared with the CBHL.

The officer should notify the subject they are being referred to the CBHL program for possible services and provide the subject with the CBHL pamphlet available at any of the District Stations.

The officer will then refer the subject to the CBHL using the most current method, currently a fillable form under the reports tab on the Agency intranet page. Once filled out and submitted, the form is sent directly to the CBHL. The referral will include, at a minimum, the event/report number, the subject's full identifying and contact information, a summary of the officer's contact with the subject and a brief explanation of why the subject may need services. The CBHL program will receive the referral and follow up with the referred subject.

Participation with the CBHL program by the referred subject is strictly voluntary.



Administrative and Operational Manual

September 12, 2022

## 4-232 EMERGENCY PSYCHIATRIC EVALUATION PETITIONS

The Health Article of the Annotated Code of Maryland gives “peace officers” certain rights and responsibilities regarding persons who are diagnosed with, or are exhibiting behavior indicative of, a mental disorder. When dealing with such individuals, employees of the CCSO will follow the dictates of the law and any additional requirements placed by this section.

### 4-232.1 DEFINITIONS

In this section, the following words have the meaning indicated.

**Court** - means a district or circuit court of Maryland.

**Emergency evaluatee** - means an individual for whom an emergency evaluation is sought or made under this section.

**Emergency facility** - means a facility that the Maryland Department of Health and Mental Hygiene designates, in writing, as an emergency facility.

**Mental disorder** - means the behavioral or other symptoms that indicate:

- to a lay petitioner who is submitting an emergency petition, a clear disturbance in the mental functioning of another individual; and
- to a physician or psychologist doing an examination, at least one mental disorder that is described in the version of the American Psychiatric Association’s Diagnostic and Statistical Manual - Mental Disorders that is current at the time of the examination.

Mental disorder does not include mental retardation.

**Peace officer** - means a sheriff, a deputy sheriff, a State Police officer, a County Police officer, a municipal or other local police officer, or a Secret Service agent who is a sworn special agent of the United States Secret Service or Treasury Department authorized to exercise powers delegated under 18 U.S.C. § 3056.

### 4-232.2 EMERGENCY FACILITIES

A list of emergency facilities is published each year by the Maryland Department of Health and Mental Hygiene. The Department will provide this list to each health department, judge of a court, sheriff's office, police station, and Secret Service office in this state. When received in the Office of the Sheriff, this list will be distributed to all division commanders. The Patrol operations commanders will require a copy of the current list be maintained at the front desk area of each district station. The Support Services Commander will require a copy of the current list be maintained by each supervisor in the Communications Section. The information will thus be immediately available to employees making a request by radio or telephone.

In most instances, the nearest emergency facility will be Charles Regional Medical Center in La Plata (CRMC). However, officers must request Police Communications contact CRMC to determine whether or not the facility is able to accept the person. If not, alternate arrangements may be made by Police Communications, and the transporting officer will be advised. If alternative arrangements cannot be made, Charles Regional Medical Center will be required to accept the evaluatee. An appropriate operational / district commander will be contacted if necessary.



Administrative and Operational Manual

September 12, 2022

---

### 4-232.3 PETITION FOR EMERGENCY EVALUATION

A petition for emergency evaluation of an individual may be made only if the petitioner has reason to believe the individual presents a danger to the life and safety of the individual or others.

The petition for emergency evaluation of an individual may be made by:

- a physician, a psychologist, or a health officer or designee of a health officer who has examined the individual;
- a peace officer who personally has observed the individual or the individual's behavior; or
- any other interested person.

A peace officer who makes a petition for emergency evaluation commitment may base the petition on:

- the examination or observation; or
- other information obtained that is pertinent to the factors giving rise to the petition.

A petition shall:

- be signed and verified by the petitioner;
- state the petitioner's name, address, and home and work telephone numbers;
- state the emergency evaluatee's name, and description;
- state the following information, if available: the address of the emergency evaluatee, and the name and address of the spouse or a child, parent, or other relative of the emergency evaluatee or any other individual who is interested in the emergency evaluatee;
- contain a description of the behavior and statements of the emergency evaluatee that led the petitioner to believe the emergency evaluatee has a mental disorder, and that the individual presents a danger to the life and safety of the individual or others; and
- contain any other facts supporting the need for an emergency evaluation.

The petition form shall contain a notice that the petitioner:

- may be required to appear before a court; and
- makes the statements under penalties of perjury.

A petitioner who is a physician, psychologist, health officer, or designee of a health officer shall give the petition to a peace officer.

The peace officer shall explain to the petitioner:

- the serious nature of the petition; and
- the meaning and content of the petition.

#### 4-232.3.1 EMERGENCY PETITION AT THE CHARLES COUNTY DETENTION CENTER



**Administrative and Operational Manual**

**September 12, 2022**

If a correctional officer has reason to believe a prisoner / inmate who is currently being released from the Charles County Detention Center presents a danger to his / her own life or safety or to that of others, the correctional officer will notify his supervisor. The supervisor will contact Communications and request a patrol officer to respond. The correctional officer will immediately complete an Incident Report and have the report ready to give to the patrol officer once he arrives. The patrol officer may use this report in his investigation. Once the patrol officer has arrived, the correctional officer will present evidence as to how the prisoner / inmate presents a danger to his / her own life or safety or to that of others. If the evidence presented meets the requirements of the State of Maryland for an Emergency Evaluation and supports the patrol officer's investigation, then the patrol officer will complete the petition and transport the prisoner / inmate to the hospital for evaluation.

If the responding patrol officer feels that, upon evaluation, the prisoner / inmate does not meet the criteria for an emergency petition, the patrol officer will contact his supervisor and then document all information in the call sheet notes.

In instances where a prisoner / inmate currently incarcerated or in the custody of the Charles County Detention Center presents a danger to his / her own life or safety or that of others, the matter will be handled internally within the Charles County Detention Center. No assistance will be required of Patrol Operations. The Charles County Detention Center will handle the matter per policy, and this will be done by the Mental Health staff.

#### **4-232.4 DUTY OF PEACE OFFICER**

A peace officer shall take an emergency evaluatee to the nearest emergency facility if the peace officer has a petition that:

- has been endorsed by a court within the last five (5) days; or
- is signed and submitted by a physician, a psychologist, a health officer or designee of a health officer, or a peace officer.

After a peace officer takes the emergency evaluatee to an emergency facility, the peace officer need not stay unless:

- the emergency evaluatee is violent and a physician asks the supervisor of the peace officer to have the peace officer stay; or
- the evaluatee is under arrest.

If a physician asks that a peace officer stay, a physician shall examine the emergency evaluatee as promptly as possible.

When a juvenile has been taken into custody for emergency evaluation pursuant to court order, petition signed by a competent mental health authority, or a peace officer's observations, the juvenile's parent or guardian shall be notified to respond to the treating facility as soon as possible to grant permission for treatment.

#### **4-232.5 JUDICIAL SERVICES**

Emergency petitions received by this Agency for service from the courts, physician, psychologist, or a health officer will be forwarded to the Judicial Services Section. Petitions will be entered into the Agency CAD system under the "Civil Paper" file as an active paper for service. Judicial Services will then forward the petition to Patrol Operations for service attempts.

Once a petition is served, a copy of the service will be forwarded to Judicial Services and removed from "Active"



**Administrative and Operational Manual**

**September 12, 2022**

status to "Served." Petitions issued by the courts must be served within five (5) days after issuance. All others will remain active until either served or recalled by a court order.

If a petition is received after normal business hours and a representative from Judicial Services is unavailable, Patrol Operations will attempt service immediately. A copy of the petition will be forwarded to Judicial Services for entry into the CAD system at a later time.

#### **4-232.6 ARREST ALTERNATIVE**

The arrest of a mentally disordered individual may not be the best way to handle minor law violations. However, in serious cases where a violation of law has occurred, such persons may be arrested the same as any other. In cases where a felony has been committed, or where the officer has found it necessary to use significant force to effect the apprehension of an individual, charges are warranted.

In cases where charges are placed, the arresting officer will:

- communicate any observations of the arrestee's mental state in the probable cause section of the arrest document; and
- advise the District Court Commissioner of the arrestee's actions and condition; and
- advise the intake officer and medical personnel at the Detention Center of the actions and condition of the arrestee.

#### **4-232.7 PETITIONS INITIATED BY OFFICERS**

When an officer observes behavior which fulfills the requirements for the justification of a petition, the officer may take a person into custody in the same manner as he would a person arrested. The officer will execute a Petition for Emergency Evaluation (Form #CC / DC-13), and sign it as a peace officer.

The officer will take the person to the nearest emergency facility. If circumstances warrant, the person may be transported by ambulance. The officer will remain with the person only until the person is accepted by the emergency facility. However, if the person is violent, and a physician asks the officer to stay with the person, the officer will stay and call a supervisor to the emergency facility.

The responding supervisor will allow the officer to remain with the person at the emergency facility, providing the physician examines the person promptly. If the supervisor leaves the facility, the supervisor will check with the officer occasionally to determine that the examination is completed in a timely manner.

Upon arrival at a medical facility, the officer will immediately request hospital security be notified and asked to respond to the officer's location.

The officer will inform security personnel of the evaluatee's actions and/or statements which led to the evaluatee being taken into custody.

The officer will contact the attending physician and inform him of the evaluatee's actions and/or statements which led to the evaluatee being taken into custody.

Constant observation of the evaluatee will be maintained either by the officer or security personnel.





Administrative and Operational Manual

September 12, 2022

The officer will inform the evaluatee an emergency evaluation is going to be conducted and the evaluatee is not permitted to leave the medical facility until released by a physician.

#### 4-232.8 SERVING PETITIONS NOT INITIATED BY AN OFFICER

Officers are required to serve petitions which are properly executed by a Maryland district or circuit court, or those executed by a physician, psychologist, or a health officer, or designee of a health officer who has examined the individual. If the petition is one endorsed by the court, it must have been endorsed within the last five (5) days.

Petitions from the court not served within five (5) days will be returned to the court with an indication "Not Served." Return will require the completion of an Incident Report, to which will be attached a copy of the unserved petition. There is no expiration date on petitions executed by physicians, psychologists, or health officers or designees of health officers.

When petitions are received and the person who is the subject of the petition is not immediately available, officers will attempt to develop information concerning the best way to take the person into custody. This information may be obtained from the physician or other petitioner, or from the person's relatives or friends. A supervisor will approve the serving of all petitions where the person is not immediately available. The supervisor will check the available information and the planned method of taking the person into custody.

#### 4-232.9 COMPLETION OF REQUIRED REPORT

The serving of an emergency petition initiated by an officer will require the completion of an Incident Report. The report will describe the circumstances surrounding the need for the emergency petition. The method of taking the person into custody will be described, including:

- any planning which may have been accomplished before the person was taken into custody; and
- the actions of the person taken into custody; and
- a description of any injuries the person taken into custody may have sustained; and
- a description of the way in which the person taken into custody was injured; and
- the method in which the person taken into custody was transported; and
- the facility to which the person was transported; and
- the physician or other person at the emergency facility to whom the person's custody was transferred.

A copy of the served petition will be attached to the Incident Report. Any other information which might be relevant to the incident, or the defense of proper police actions in regard to the taking into custody and transportation will be documented.

If a petition is initiated by a court, physician, psychologist, health officer or designee, no report will be necessary unless unusual circumstances arise during the period the subject was taken into custody and released to a hospital for an evaluation. A report will be taken if the petition was not served, outlining the attempts for service and any additional information obtained concerning the evaluatee by an officer from the patrol district the evaluation was assigned.

#### 4-232.10 LAY PETITIONERS

When officers are questioned by a person who is not a physician, psychologist, or a health officer, or designee of a



**Administrative and Operational Manual**

**September 12, 2022**

---

health officer, concerning a person who may have a mental disorder, and who is not in the officer's presence, the officer will direct the person to the Clerk of the Court's Office. The person will be told of the requirements of the law regarding the request to the court for a petition.

#### **4-232.11 DISTRIBUTION OF SERVED PETITIONS**

When a petition is served, copies shall be distributed as follows:

- unless issued by a court, the originals of all forms are to be left at the emergency facility which assumes custody of the evaluatee;
- when issued by a court, a copy will be left with the emergency facility and the original and return are to be completed and sent back to the court;
- one copy of all forms will be attached to the Incident Report to be forwarded to Records Management; and
- a copy of all forms will be made and forwarded to Judicial Services.



Administrative and Operational Manual

September 12, 2022

## 4-233 DOMESTIC VIOLENCE

It is the policy of the Charles County Sheriff's Office to respond as quickly as possible, take control of the scene, and protect victim(s) of domestic violence from further harm. "Domestic violence" may mean different things in different contexts. Unless otherwise specified, "domestic violence" in this section, as well as in AOM 1-102, and 5-100.3, refers to:

- An assault in any degree or any act that places a person in fear of imminent serious bodily harm, and the parties are:
  - Spouses, whether married, separated, or divorced;
  - Have a child or children in common; or
  - Have been involved in a sexual relationship within the last 12 months.

An incident report will be generated for any assault where the parties are in one of the above relationships. In all other instances, officers should use their discretion in determining whether to generate an incident report.

When responding to calls where domestic violence is apparent or alleged, officers must be alert, impartial, and concerned with victims' needs. While being impartial and caring, officers must always anticipate the unexpected. Domestic conflicts can quickly escalate into a dangerous situation due to the explosive range of intense emotions involved. Officers called upon to act in cases of domestic violence should have the following goals and purposes in mind:

- Protecting victims of domestic violence;
- Apprehending violators of the domestic violence laws, ex parte orders, and protection orders;
- Providing information for obtaining continued protection from abusers;
- Providing information concerning support services for victims of domestic violence; and
- Reducing domestic violence in Charles County by providing information concerning avenues of relief and consequences of acts of domestic violence to affected families.

All domestic violence incidents will be approached with professionalism and thoroughly investigated to determine if a crime was committed. Evidence will be collected in the same manner as with other crime scenes using all available resources. If probable cause exists that an act of domestic violence has occurred, an arrest shall be made when allowed by law, or charges applied for prior to the end of the officer's shift.

### 4-233.1 DISPATCHING COMPLAINT OF DOMESTIC VIOLENCE

The response classification for complaints of domestic violence will be assigned in accordance with Section 4-111 of this Manual and information received from the reporting person. A minimum of two (2) officers shall be assigned to the call. The Communications officer shall provide the officers all available information regarding the call.

Communications shall make note in the computer record that a Victim / Witness Pamphlet (Section 4-233.5) was / was not issued to the victim and if a Lethality Assessment Program Form (LAP) was completed. If the officer clearing the call does not advise that a pamphlet was issued, Communications will inquire of the officer concerning it. If, upon clearance, the pamphlet was not issued for a call which remains classified as domestic violence, Communications will cause a copy of the call to be printed and forwarded to the officer's commander for review. The commander will ensure that the appropriate action was taken as required by this policy.

### 4-233.2 RESPONDING OFFICER PROCEDURES AND RESPONSIBILITIES



Administrative and Operational Manual

September 12, 2022

Any person who alleges to have been a victim of abuse and who believes there is a danger of serious and immediate injury to himself or herself may request assistance from the Charles County Sheriff's Office. The first responsibility of an officer responding to a request for assistance shall be to attempt to protect the complainant from harm.

Upon arrival on the scene, officers will identify themselves and request permission to enter the home. If confronted by one of the involved parties who declines assistance, officers should insist that the other involved party come to the door to determine whether violence has occurred.

Generally, officers should enter homes only when invited and when significant opposition to the invitation is not displayed. A forcible entry into the home by police may be made if exigent circumstances exist. Such circumstances may include screams, report of screams, assault, visible signs of violence, and information obtained through Communications. Officers must examine the facts of the situation in order to determine an appropriate action. Officers may make a forcible entry to terminate a violent altercation or remove children whom the officer believes are in immediate danger; however, the perception of danger must be the officer's, not the parent's.

When responding to calls of domestic violence, officers shall adhere to the following policy:

- Officers shall refrain from forcibly entering a home merely to obtain clothing or personal items that are not of an absolute necessity.
- Officers will not assist in removing children from a home in which one spouse opposes, no custody order or other court order is in effect, and circumstances do not indicate that the children are in imminent danger.
- Officers will restore order by gaining control of the situation, then:
  - assess the need for medical attention and call for medical assistance if indicated, and
  - interview all parties, collect and record evidence, and
  - where appropriate, take photographs of injuries and property damage.
- If a person meeting the Domestic Violence criteria alleges to have been abused, or exhibits an injury, an incident report will be completed.
  - Where the necessary elements for a warrantless arrest are present, an arrest shall be made.
- Where probable cause exists that a crime has been committed and the suspect is not on the scene, the officer shall:
  - give a look-out and conduct or request a check of the immediate area, or other areas, as indicated by information obtained;
  - obtain pertinent information about the suspect from victims and witnesses; and
  - if not immediately located, apply for charges against the suspect before the end of the shift.

Under Maryland law, any law enforcement officer, responding to a request for assistance in domestic violence cases, shall, by law, be immune from civil liability, in complying with the request, if acting in good faith and in a reasonable manner.

Officers who respond to calls for assistance with regard to domestic violence will present the complainant and/or



**Administrative and Operational Manual**

**September 12, 2022**

other abused person(s) with the Victim / Witness Pamphlet. The officer will briefly explain the pamphlet to the victim (such as how to apply for an ex parte order and how to contact organizations offering support and/or shelter). The officer will answer any questions the complainant may have regarding the information presented. The officer will record his name, I.D. number, date of the incident, case number, and Agency telephone number on the pamphlet. Officers will note in the Offense / Incident Report the names of persons provided the pamphlet. When clearing these calls, the clearing officer will advise communications that a Victim / Witness pamphlet was issued.

### **4-233.3 LETHALITY ASSESSMENT PROGRAM (LAP)**

Officers shall conduct a lethality assessment when an officer responds to a domestic violence event as defined in 4-233 and a report is written. These assessments are designed to mitigate circumstances which have the potential for significant or even deadly harm occurring to one or more of the persons involved in the domestic violence event.

For assaults that are not defined in 4-233, the need for an incident report is at the discretion of the officer, especially when the LAP does not apply as listed below:

- parent - child events;
- sibling relationships; or
- those involving a dating relationship, where the parties involved are not, or have not, lived together.

The Center for Abused Persons (CAP) Lethality Assessment Program (LAP) form is the device used to collect the needed data for lethality assessment decision-making. The victim of the domestic assault will be asked each of the eleven questions contained on the form. The victim's answers will be recorded on the form.

An affirmative response on any of the first three questions or an affirmative response to four of the remaining eight questions indicates a high danger situation and will require a referral to the Center for Abused Persons.

### **4-233.4 CENTER FOR ABUSED PERSONS REFERRAL**

When a lethality assessment indicates a high danger situation, based on the victim's responses to the questions asked from the assessment form, the officer will call the Center for Abused Persons Hotline. CCSO Communications will maintain the current telephone number, should the officer not have it available.

It is preferable to call from the victim's telephone (with the victim's permission) and then have the victim talk with a counselor. If the victim refuses, the officer should explain the LAP just completed indicates a danger level threshold where a conversation with a counselor is recommended. If the victim still refuses, the officer should disconnect with the counselor and leave the victim the telephone number of the hotline and reaffirm the request to call it.

Documentation of all activities should be made on the domestic assault report, especially the victim's refusal to speak with a counselor. If the officer is unable to contact the Center on the telephone while at the scene, a call should be initiated at the officer's earliest opportunity in order to inform the Center of the results of the Lethality Assessment Program Form. (LAP).

Completed LAP forms will be submitted to the Domestic Violence Supervisor via scanned document, inter-office mail, or fax. This task will be completed prior to the end of the shift. The Domestic Violence Supervisor will forward copies of the LAP to the Records Section (as an attachment to the incident report) and to the Center for Abused Persons (CAP).



## Administrative and Operational Manual

September 12, 2022

## 4-233.5 WARRANTLESS ARRESTS FOR MISDEMEANOR ASSAULTS

Officers may make a warrantless arrest if there is probable cause to believe the person being arrested has committed a felony (such as first degree assault) or that the person has committed a misdemeanor in the presence of the officer.

§2-204 of the Criminal Procedure Article of the Annotated Code of Maryland also provides that a police officer may arrest a person without a warrant if the officer has probable cause to believe that:

- the person battered that person's spouse or other individual with whom the person resides;
- there is evidence of physical injury; and
- a report to the police was made within 48 hours of the alleged incident; and
- unless the person is immediately arrested:
  - the person may not be apprehended;
  - the person may cause injury to the person or damage to the property of one or more other persons; or
  - the person may tamper with, dispose of, or destroy evidence.

In those cases involving spouses, persons with children in common, or in a sexual relationship within the last 12 months, a warrantless arrest shall be made where the elements for a warrantless arrest exist. If an officer is unable to make the arrest because the suspect could not be located, an application for charges shall be made as soon as possible unless a prosecutor from the State's Attorney's Office advises not to charge.

§2-204 of the Criminal Procedure Article is titled "Domestic Abuse or Violence" but the title is misleading. §2-204 relates only to a spouse or other persons living in the home, even unrelated persons. §2-204 does not include boyfriend / girlfriend relationships where the parties are dating but not living together.

§2-204 also does not require *visible* signs of injury. It requires only "evidence of injury" that is credible to an officer. Such evidence may include a victim's description of injury or physical actions / reactions; or a stated intention to seek medical treatment may satisfy the evidence of injury requirement.

§2-204 requires that if the officer has probable cause to believe that mutual battery occurred and a warrantless arrest is necessary under this law, the officer shall consider whether one of the parties acted in self-defense when making the determination whether to arrest the person whom the officer believes to be the primary aggressor.

### ***Summary of Warrantless Arrests for Domestic Violence***

Officers responding to a complaint of domestic violence as defined in Section 4-233 shall make a warrantless arrest if:

- The officer has probable cause to believe a felony had been committed;
- The officer has probable cause to believe a misdemeanor is occurring in the officer's presence; or
- The criteria for a warrantless arrest under §2-204 of the Criminal Procedure Article exist.

## 4-233.6 ORDERS FOR PROTECTION (INTERIM, TEMPORARY, AND FINAL)

### **DEFINITIONS RELATING TO ORDERS FOR PROTECTION**

In the context of orders for protection, the following words have the following definitions:



Administrative and Operational Manual

September 12, 2022

**Abuse:** means any of the following acts:

- an act that causes serious bodily harm;
- assault in any degree;
- an act that places a person eligible for relief in fear of imminent serious bodily harm;
- rape or sexual offense or attempted rape or sexual offense;
- false imprisonment;
- abuse of a vulnerable adult, or
- stalking; or
- abuse of a child, including “abuse” as defined in the Family Law Article (FL § 5-701).
- revenge porn under §3-809 of the Criminal Law Article

**NOTE:** Reasonable punishment of a child, including reasonable corporal punishment by a parent or legal guardian of the child, is not “abuse.”

**Persons eligible for relief (ex parte / protective order):** includes:

- the current or former spouse of the respondent;
- a co-habitant of the respondent (“cohabitant” means a person who has had a sexual relationship with the respondent and resided with the respondent in the home for a period of at least 90 days within 1 year before the filing of the petition);
- a person related to the respondent by blood, marriage, or adoption;
- a parent, stepparent, child, or stepchild of the respondent or the person eligible for relief who resides or resided with the respondent or person eligible for relief for at least 90 days within 1 year of the incident or the filing of the petition;
- a vulnerable adult who lacks the physical or mental capacity to provide for their daily needs; or
- an individual who has a child in common with the respondent; or
- an individual who has had a sexual relationship with the respondent within 1 year before the filing of the petition.

**Respondent:** a person alleged to have caused a domestic disturbance or act of abuse.

**Petitioner:** a person who is eligible to request or is requesting relief from domestic violence.

## 4-233.7 INTERIM PROTECTIVE ORDERS

An interim protective order may be issued by a District Court Commissioner when either the Circuit or District Courts are closed for business. Such interim orders are effective until a temporary protective order hearing is held by the court or until the end of the second business day on which the Office of the District Court is open for business. An interim protective order may provide for the following relief:

- order the respondent to refrain from further abuse or threats of abuse of a person eligible for relief;
- order the respondent to refrain from contacting, attempting to contact, or harassing any person eligible for relief;



Administrative and Operational Manual

September 12, 2022

- order the respondent to refrain from entering the residence of a person eligible for relief;
- if a person eligible for relief and the respondent are residing together at the time of the alleged abuse:
  - order the respondent to vacate the home immediately;
  - award temporary custody of a child;
  - use reasonable and necessary force to remove a child from the home if necessary; and
  - award temporary use and possession of the home to the person eligible for relief;
- in a case alleging abuse of a child, award temporary custody of a minor child of the respondent and the person eligible for relief;
- in a case alleging abuse of a vulnerable adult, award temporary use and possession of the home to an adult living in the home;
- order the respondent to remain away from the place of employment, school, or temporary residence of a person eligible for relief or the home of other family members.

#### 4-233.8 INTERIM PROTECTIVE ORDER PROCEDURES

Upon retrieving an interim protective order from the District Court Commissioner's Office, the patrol officer will transport the order to the Sheriff's District 1 Station, where the police station technician or Judicial Services Office Associate will enter the order into the local computer system and into METERS / NCIC.

Within one (1) hour after serving an interim protective order to the respondent, the patrol officer will transport the served order to the nearest district station.

Within one (1) hour after receipt of a served interim protective order, the police station technician or Judicial Services Office Associate will modify the METERS / NCIC entry to indicate that the order has been served.

If an interim protective order is served on behalf of a Maryland jurisdiction outside of Charles County, the Police Station Technician or Judicial Services Office Associate will enter the required information into the new VINE Direct Notification Form within one (1) hour of service of the order. This act will send a Service Notification Administrative Message (SNAM) to the originating agency and will automatically trigger notification to the Department of Public Safety and Correctional Services (DPSCS) that the order has been served.

If an interim protective order is served on behalf of an agency outside the State of Maryland, the Police Station Technician or Judicial Services Office Associate will fax the Return of Service to the originating agency within one (1) hour of service of the order. The new law does not change current policy and procedure in regard to orders served on behalf of agencies outside the State of Maryland.

If an interim protective order was faxed from Charles County to a Maryland jurisdiction outside of Charles County, the Police Station Technician will await notification of service via the Service Notification Administrative Message (SNAM). The Police Station Technician will then forward the SNAM to the Domestic Violence Unit. Upon receipt of the SNAM, the Domestic Violence Specialist will modify the METERS / NCIC entry to indicate that the order has been served and which agency has served the order.

If the service of an interim protective order occurs on the date of the order's expiration, the notification of service must be completed through the VINE Direct Notification Form in METERS, as the METERS system will not allow an entry to be modified on the date that the order is set to expire. This will be completed by the Police Station





Administrative and Operational Manual

September 12, 2022

Technician or Judicial Services Office Associate within one (1) hour after service of the order.

If an interim protective order has been served by an agency outside the State of Maryland, the Domestic Violence Specialist will modify the METERS / NCIC entry to indicate that the order has been served. This will occur within one (1) hour after the specialist has been notified by the serving agency that the order has been served, usually after receipt of the Return of Service from the serving agency via U. S. mail or fax directly to the Domestic Violence Unit.

#### **4-233.9 TEMPORARY AND FINAL PROTECTIVE ORDER PROCEDURES**

Within one (1) hour after serving a temporary or final protective order to the respondent, the Domestic Violence Officer will transport the served order to the Domestic Violence Unit.

Within one (1) hour after receipt of a served temporary or final protective order, the Domestic Violence Officer or the Domestic Violence Specialist will modify the METERS / NCIC entry to indicate that the order has been served.

If the final protective order is not served to the respondent at the Charles County Courthouse, the Domestic Violence Officer will mail the order to the respondent's last known address as allowed by law. The final protective order will be mailed on the same date as the issuance of the order. Once mailed, the final protective order will be considered served on the respondent.

If a temporary or final protective order is served on behalf of a jurisdiction outside Charles County, the Domestic Violence Officer or the Domestic Violence Specialist will enter the required information into the new VINE Direct Notification Form within one (1) hour of service of the order.

If a temporary or final protective order is served on behalf of an agency outside the State of Maryland, the Police Station Technician or Judicial Services Office Associate will fax the Return of Service to the originating agency within one (1) hour of service of the order. The new law does not change current policy and procedure regarding orders served on behalf of agencies outside the State of Maryland.

If the Domestic Violence Officer or the Domestic Violence Specialist has faxed a temporary or final protective order from Charles County to a Maryland jurisdiction outside Charles County, the Domestic Violence Specialist will await notification of service via the Service Notification Administrative Message. Upon receipt of the SNAM, the Domestic Violence Specialist will modify the METERS / NCIC entry to indicate that the order has been served and which agency has served the order.

If the service of a temporary protective order occurs on the date of the order's expiration, the notification of service must be completed through the VINE Direct Notification Form in METERS, as the METERS system will not allow an entry to be modified on the date that the order is set to expire. This will be completed within one (1) hour after service of the order by the Domestic Violence Officer or the Domestic Violence Specialist.

If a temporary or final protective order has been served by an agency outside the State of Maryland, the Domestic Violence Specialist will modify the METERS / NCIC entry to indicate that the order has been served. This will occur within one (1) hour after the specialist has been notified by the serving agency that the order has been served, usually after receipt of the Return of Service from the serving agency via U.S. mail or fax directly to the Domestic Violence Unit.

#### **4-233.10 VIOLATIONS OF PROTECTIVE ORDERS**

Officers of this Agency have a responsibility to enforce certain provisions of these orders. Officers shall make warrantless arrests or, when the respondent cannot be immediately located, apply for charges as soon as possible.

The violation of certain provisions of a protective order is a misdemeanor for which an arrest can be made. These



Administrative and Operational Manual

September 12, 2022

provisions are as follows:

- order the respondent to refrain from further abuse or threats of abuse of a person eligible for relief;
- order the respondent to refrain from contacting, attempting to contact, or harassing any person eligible for relief;
- order the respondent to refrain from entering the residence of a person eligible for relief;
- order the respondent to surrender to law enforcement authorities any firearm in the respondent's possession and to refrain from possession of any firearm;
- order the respondent to vacate the home; and
- order the respondent to remain away from the place of employment, school, or temporary residence of a person eligible for relief or home of other family members.

**NOTE:** Residence includes yards, grounds, outbuildings, and common areas surrounding a dwelling.

Any officer needing to verify the existence of a valid order may request an immediate METERS inquiry be made or may contact the agency responsible for service of the order. Protective orders issued by a judge in any Maryland jurisdiction are valid throughout the State of Maryland.

#### 4-233.10.1 NON-ARRESTABLE PROTECTIVE ORDER VIOLATIONS

Officers are cautioned that the following provisions of these orders are not grounds for arrest:

- child custody;
- child visitation;
- emergency family maintenance;
- use and/or possession of a vehicle;
- attending counseling; and
- order to stay away from a childcare provider of a person eligible for relief while the child is in the care of the provider.

These violations should be referred to the appropriate court by the person eligible for relief and could subject the person violating the provision to sanctions by the court. Officers are reminded they should arrest only for those provisions listed in Section 4-233.10.

#### 4-233.11 OUT-OF-STATE PROTECTIVE ORDERS

An ex parte / protective order issued by a court of another state (to include the District of Columbia, Puerto Rico, or other U.S. territorial possession) or Indian tribe shall be accorded full faith and credit by a court of this state and shall be enforced only to the extent that the order affords relief that is permitted in Maryland under FL § 4-505 and 4-506 (d).

Officers of this Agency shall, where the out-of-state order meets the criteria outlined in this section of the Manual, arrest, with or without a warrant, any person whom they have probable cause to believe is in violation of a civil protective order issued by a court of another state or Indian tribe. The order must be in effect at the time of the violation, and the person seeking the assistance of a law enforcement officer must:



Administrative and Operational Manual

September 12, 2022

- have filed a copy of the order with the District or Circuit Court of Maryland and provide proof of filing; or
- display to the officer a copy of a non-expired out-of-state order, wherein the violation is one that is consistent with a violation of a Maryland protective order for which an arrest can be made.

The officer is not required to authenticate an out-of-state order which appears valid on its face. An officer shall examine the order for the:

- proper names of the parties;
- date of issuance of the order;
- any expiration date;
- terms and conditions against the abuser;
- name of the issuing court; and
- signature of a judicial officer.

Absent a METERS / NCIC record of the order having been filed with the court, an officer may make a telephone inquiry of a court if the person eligible for relief states the order was recently filed with the court. If the officer is unable to view the out-of-state document or to determine it has been filed with the court, the officer will refrain from making an arrest except for arrest for other Maryland violations (assault, destruction of property, disorderly, etc.).

If an arrest cannot be made, the officer will take such steps as are possible to assist the victim with safety planning or direction to services available for victim assistance. The officer will provide any reasonable assistance to connect the victim with available services.

#### 4-233.12 REMOVAL OF FIREARMS

When responding to the scene of an alleged act of domestic violence, a law enforcement officer may remove a firearm from the scene if:

- the law enforcement officer has probable cause to believe that an act of domestic violence (as described in Family Law) has occurred; and
- the law enforcement officer has observed the firearm on the scene during the response.

Firearms will also be removed when so designated in temporary protective orders and in all final protective orders. When a temporary protective order states that the respondent will surrender all firearms, the officer(s) serving the order will inquire of the respondent whether he possesses any firearms. If so, the officer will instruct the respondent that they must immediately surrender the firearms or subject themselves to arrest. When the respondent denies possessing a firearm, the officer will instruct the respondent that possession of a firearm is a violation of law and would subject the respondent to an immediate arrest. Whenever a firearm is removed in any of the above cases, the officer shall:

- advise the owner that the firearm is being recovered pursuant to provisions in Family Law and will be placed in Property Held;
- advise the owner that he should contact the Firearms Tracking Specialist for information on the release of the firearm;
- place the recovered firearm(s) in Property Held after completing a Property Report Form #60 with detailed information on the circumstances of recovery, along with a computer printout of the wanted check on the weapons attached to the form;



Administrative and Operational Manual

September 12, 2022

- complete an incident report for recovered property which details the circumstances concerning the removal of the firearm(s); and
- if a current ex parte / protective order is in effect, attach a copy to the Property Report Form #60.

#### 4-233.13 DOMESTIC STANDBYS

Maryland law requires law enforcement officers to provide standbys to a victim of domestic violence upon request. Officers shall accompany the complainant to the family home so that the complainant may remove the following items, regardless of who paid for the items:

- the personal clothing of the complainant and of any child in the care of the complainant; and
- the personal effects, including any medicine or medical devices, of the complainant and of any child in the care of the complainant that are required for the immediate needs of the complainant or the child.

Only items considered immediate necessities shall be removed. Items such as televisions, stereos, and DVD players are not considered necessary personal effects. Officers should use good judgment in deciding what personal effects are necessary (usually limited to toiletries, clothing, and items necessary for work).

Officers should refrain from forcibly entering a home merely to obtain clothing or personal items, unless such items (i.e., needed medication) are an absolute necessity that if not obtained may create a life-threatening situation. In cases where there is opposition to entrance into the home to collect items, officers shall consult with a supervisor. The supervisor may, if circumstances warrant, authorize forced entry.

Officers should be cautioned that if a respondent of an ex parte / protective order requests police assistance in entering a residence where the courts have ordered him / her away, that this would constitute a violation of the order. Officers in these instances will only offer advice about the legal way of obtaining the personal items. Such advice might include the possibility of obtaining property through a third party or family member not a part of the court order.

#### 4-233.14 DOMESTIC VIOLENCE INVOLVING LAW ENFORCEMENT OFFICERS

Law enforcement agencies in the State of Maryland are committed to prevention of crimes and the arrest and prosecution of offenders, including those offenders found within the ranks of law enforcement. Communication between law enforcement agencies is critical to the effective enforcement of state law, federal law, and Agency policies. It is the policy of this Agency to thoroughly report crimes of domestic violence.

When an officer of this Agency is serving an ex parte / protective order or responds to a call for domestic violence and finds the alleged offender is a law enforcement officer from another agency, he shall:

- complete a Commanders' Information Report and any other reports as required; and
- ensure notification to the involved officer's agency is made within four (4) hours of the incident. The assistance of the Domestic Violence Unit may be obtained in making the required notifications.

When an officer of this Agency is serving an ex parte / protective order, or responds to a call for domestic violence and finds that the alleged offender is a law enforcement officer from the Charles County Sheriff's Office, he shall:

- immediately call for a supervisor to respond to the scene; and
- complete an I.R. and Commanders' Information Report, regardless of whether an arrest is made.

Supervisor's responsibilities:



Administrative and Operational Manual

September 12, 2022

- respond to the scene of all domestic violence incidents involving a law enforcement officer;
- ensure an investigation is completed, that the incident is properly handled in accordance with procedures set out in this section and is properly documented; and
- ensure notification to the involved officer's agency is made within four (4) hours of the incident and that all other required notifications are made.

When any law enforcement officer is served an ex parte or is involved in a domestic violence related crime, the appropriate individual (duty officer, commander, internal affairs, etc.) at the officer's agency shall be contacted in order to determine if the service weapon should be recovered, even when not so ordered by the court. In addition, where ordered by the courts, all other firearms in the home shall also be confiscated.

When an officer of this Agency is served as a respondent under an ex parte / protective order, he shall ensure immediate notification is made to his supervisor, or if unavailable, an on-duty supervisor. The supervisor shall immediately notify the respondent officer's commander, who shall make notification through the chain of command to the Sheriff.

For incidents involving officers of this Agency where the courts have not ordered that firearms be confiscated, the authorization to carry any off-duty firearm will be withdrawn during the period that the order is in effect.

The duty status of Charles County Sheriff's Officers who are respondents in domestic violence cases will be determined as outlined in Sections 3-706 – 3-708 of this Manual that deals with suspensions.

#### 4-233.15 PEACE ORDERS

A person who is not eligible for an ex parte / protective order may seek relief from violence or harassment through a temporary peace order / peace order. A petitioner must apply under oath for a temporary peace order through the courts.

Once granted, a temporary peace order may be effective for not more than seven (7) days after service of the order, and will include a date and time of a peace order hearing. A peace order may be granted and extend the relief to the petitioner for up to six (6) months after the hearing. The following violations will warrant the issuance of a temporary peace order:

- an act that causes serious bodily harm;
- an act that places the petitioner in fear of imminent serious bodily harm;
- assault in any degree;
- rape or sexual offense, or attempted rape or sexual offense in any degree;
- false imprisonment;
- harassment;
- stalking;
- trespassing; or
- malicious destruction of property.

Peace orders may provide for the following relief:

- order a respondent to refrain from committing or threatening to commit an act specified above;
- order a respondent to refrain from contacting, attempting to contact, or harassing the petitioner;
- order a respondent to refrain from entering the residence of the petitioner; and



Administrative and Operational Manual

September 12, 2022

- 
- order a respondent to remain away from the place of employment, school, or temporary residence of the petitioner (residence includes yard, grounds, outbuildings, and common areas surrounding the residence).

#### 4-233.15.1 INTERIM PEACE ORDER

An interim peace order may be issued by a District Court Commissioner when the District Courts are closed for business. Such interim orders are effective until a peace order hearing is held by the court or until the end of the second business day on which the Office of the District Court is open for business.

An interim peace order may offer the same relief as a temporary peace order.

#### 4-233.15.2 PROCEDURES

Upon the issuance of an interim peace order by a District Court Commissioner, the procedures outlined below will be followed:

- The District Court Commissioner in Charles County will notify the District I Police Station Technician by phone;
- If an order is issued by an out-of-County jurisdiction, a copy will be sent by fax to the Charles County Sheriff's Office District I Station;
- If available, the Police Station Technician will notify the Domestic Violence Unit and a member will pick up the interim peace order; if not available, the Police Station Technician will enter a call into the CAD computer to have a patrol officer pick up the interim peace order for service.

When an officer is directed by Communications to pick up and serve an interim peace order, the procedures outlined below will be followed:

- The officer will respond to either the Commissioner's office or the District I Station to pick up the order;
- The officer will take the interim peace order to the District I Station or to the Domestic Violence Clerk, where personnel there will copy the order and Return of Service, provide the officer with the respondent's copy, and enter the information into the local computer;
- If the order is to be served in the District II, III or IV area and a Domestic Violence Officer is not available to serve the order, it will be faxed to the appropriate police station technician for service;
- The supervisor in the affected district will be notified by Communications or the Police Station Technician and will coordinate an immediate attempt to serve the interim peace order on the respondent;
- In all cases where there is a vacate order, a minimum of two officers will be assigned to serve the order;
- If the interim peace order is served, a copy of the Return of Service will be faxed to the District I Station and the technician will be notified by phone; the original is to be sent by Agency mail to the Domestic Violence Office;
- The red folder with a copy of the order and a copy of the Return shall remain in the filing drawer at the District I Station;
- The next working member of the Domestic Violence Unit will pick up any served and unserved orders;



Administrative and Operational Manual

September 12, 2022

- When no Domestic Violence Unit officers are scheduled to work, on-coming shift supervisors will check the file drawer for any unserved orders and will coordinate the attempt to serve during their shift.

When an officer responds to the District I Station with an interim peace order, personnel there will:

- make a copy of the order and Return of Service;
- fax a copy to the appropriate jurisdiction if the order requires service outside the jurisdiction of Charles County, and make a note inside the jacket on the attempt service sheet what jurisdiction was notified;
- obtain a jacket number and provide the officer with the respondent's copy, the Return of Service and the information sheet;
- enter the required information into the local computer system;
- when notified by the serving officer that the interim peace order was served, update the local computer and fax and mail a copy of the service to the Domestic Violence Unit; and
- if served on behalf of a jurisdiction outside of Charles County, fax a copy to that jurisdiction and send a copy of the order and the Return of Service to the Domestic Violence Unit.

#### 4-233.15.3 TEMPORARY PEACE ORDER

Once granted, a temporary peace order may be effective for not more than seven (7) days after service of the order, and will include a date and time of a peace order hearing. A peace order may be granted and extend the relief to the petitioner for up to six (6) months after the hearing. The following violations will warrant the issuance of a temporary peace order:

- An act that causes serious bodily harm;
- An act that places the petitioner in fear of imminent serious bodily harm;
- Assault in any degree;
- Rape or sexual offense, or attempted rape or sexual offense in any degree;
- False imprisonment;
- Harassment;
- Stalking;
- Trespassing; or
- Malicious destruction of property.

#### 4-233.15.4 VIOLATIONS OF PEACE ORDERS

An individual who fails to comply with the relief granted in a temporary peace order / peace order, as stated above, is guilty of a misdemeanor.

Officers of this Agency have a responsibility to enforce certain provisions of temporary peace orders and peace orders. Officers of this Agency shall make warrantless arrests in these cases if they have probable cause to believe that a person is violating the provisions of a peace order. In cases where an immediate arrest cannot be made, officers shall make application for charges as soon as possible.



Administrative and Operational Manual

September 12, 2022

[REDACTED]

#### 4-233.17 DOMESTIC VIOLENCE REPORTING PROCEDURES

Domestic violence cases are reported to the MSP Statewide Crime Reporting Program and must contain all essential information needed for the UCR. The following information shall be included in all domestic violence reports:

- day of week, date, and time;
- relationship of the victim to the offender:
  - spouse (current or former), or
  - co-habitant (current or former);
- detailed description of any injuries;
- current household status:
  - unknown;
  - living together; or
  - estranged;
- alcohol / drug involvement;
- circumstances / causes of this domestic violence incident;
- sex, race, and date of birth of both the victim and offender;
- information on minor children;
- any prior history of violence;
- any weapons involved;
- detailed history of actual occurrence; and
- disposition - arrest, cleared no arrest, unknown.

Domestic violence reports will be so classified in addition to any criminal conduct (assault, trespassing, stalking, etc.).

#### 4-233.18 DOMESTIC VIOLENCE UNIT





## Administrative and Operational Manual

September 12, 2022

The Domestic Violence Unit has the responsibility for the service of all ex parte / protective orders issued by the courts. This unit also maintains current files on all ex parte / protective orders as a resource for the Agency.

This Unit has the responsibility for the service of all domestic violence related criminal papers (i.e., warrants and criminal summonses). All warrants and criminal summonses will be entered into all required computers and served through the Domestic Violence Unit, unless the investigating officer requests to serve the paper.

The Domestic Violence Unit is responsible for the issuance and termination of Abused Women's Active Response Emergency (A.W.A.R.E.) alarms. The Unit Supervisor shall monitor all responses to activated alarms and maintain records of where alarms are assigned in Charles County.

#### 4-233.19 STEPS TO EFFECTIVE DOMESTIC VIOLENCE INTERVENTION

The following six (6) basic steps to effective intervention in domestic violence calls will be considered in these cases:

- establish a safe environment;
- defuse the situation by calming the disputants;
- use communication skills to elicit information to determine the cause of the problem, while maintaining a neutral, non-judgmental attitude;
- provide the victim protection against further injury;
- provide information concerning the courses of action available to the victim; and
- provide information concerning the support services available to the victim.

#### 4-234 EXTREME RISK PROTECTIVE ORDER

##### 4-234.1 PURPOSE

Extreme Risk Protective Orders (ERPO) are meant to prohibit a respondent from possessing a firearm where there is sufficient information to believe that the respondent poses an **IMMEDIATE** and **PRESENT DANGER** of causing personal injury to the respondent, the petitioner, or another individual by possessing a firearm. The purpose of the ERPO is to reduce gun deaths and injuries by restricting a respondent's access to firearms.

A petition for or the issuance of the ERPO does not in any way affect the ability of law enforcement to remove or seize firearms and/or ammunition from any person or property as permitted by any other law.

##### 4-234.2 DEFINITIONS

**Extreme Risk Protective Order (ERPO)** means: a civil interim, temporary, or final protective order prohibiting the respondent from possessing and purchasing a firearm and ammunition and ordering the respondent to surrender to law enforcement any firearm and ammunition in the respondent's possession for the duration of the Order.

- An **Interim ERPO** is issued when the District Court is closed. Issued by the District Court Commissioner, an Interim Order will be effective until a Temporary ERPO hearing is held in District Court.
- A **Temporary ERPO** is issued by the District Court. A hearing will be held with the petitioner at which a Temporary ERPO may be issued by a District Court Judge. A Temporary ERPO shall be effective for not more than seven (7) days after service of the Order unless extended by the judge.



Administrative and Operational Manual

September 12, 2022

- A **Final ERPO** is issued by the District Court. If a Temporary ERPO is issued, there will be a hearing at which a District Court Judge may issue a Final ERPO. A Final ERPO shall be valid for a period stated in the Order not to exceed one year unless superseded by a Circuit Court Judge's order or the Order is modified, rescinded, or for good cause shown, extended for 6 months beyond the period specified.

**Ammunition** means: a cartridge, shell, or any other device containing explosive or incendiary material designed and intended for use in a firearm.

**Firearm** means: a weapon that expels, is designed to expel, or may readily be converted to expel a projectile by the action of an explosive; or the frame or receiver of such a weapon. Firearm includes a handgun, rifle, shotgun, and starter gun.

**Petitioner** means: an individual who files a petition for an Interim, Temporary, or Final ERPO. A petitioner may be any one of the following people:

- Physician, psychologist, clinical social worker, licensed clinical professional counselor, clinical nurse specialist in psychiatric and mental health nursing, psychiatric nurse practitioner, licensed clinical marriage or family therapist, or designee of a health officer who has examined the individual;
- A law enforcement officer;
- The spouse of the respondent;
- A cohabitant of the respondent;
- A person related to the respondent by blood, marriage, or adoption;
- An individual who has a child in common with the respondent;
- A current dating or intimate partner of the respondent; or
- A current or former legal guardian of the respondent.

**Respondent** means: a person against whom a petition for an ERPO is filed.

**Possessing a firearm and ammunition** means: The respondent has firearms and/or ammunition within their control; this includes those firearms and ammunition where the respondent has access to or is within their easy reach. Possession also includes firearms and ammunition in other locations inside and outside of the respondent's residence where the respondent is not the owner of the property, but the respondent has reasonable control over the firearms and/or ammunition.

### 4-234.3 DETERMINING WHEN AN ERPO IS APPROPRIATE

An ERPO would be appropriate when information is known to the petitioner that the respondent poses an **immediate** and **present** danger of causing personal injury to the respondent, the petitioner, or any other person by possessing a firearm.

The petitioner must be able to provide supporting facts concerning the behavior and statements of the respondent or any other information that led the petitioner to believe that the respondent presents an **immediate** and **present** danger.

The petitioner must be able to describe of the number, types, and location of any known firearms believed to be



Administrative and Operational Manual

September 12, 2022

possessed by the respondent;

The petitioner may also have supporting documents or information regarding:

- Any unlawful, reckless, or negligent use, display, storage, possession, or brandishing of a firearm by the respondent;
- Any act or threat of violence the respondent made against the petitioner or against another person, whether or not the threat of violence involved a firearm;
- Any violation by the respondent of a protective order or peace order;
- Any abuse of a controlled dangerous substance or alcohol by the respondent, including any conviction for a criminal offense involving a controlled dangerous substance or alcohol; and
- Where disclosure is permitted or not otherwise prohibited by law, any health records or other health information concerning the respondent.

In all instances in which an officer believes there is sufficient information to support the issuance of an ERPO, the officer shall also advise the complainant of the procedures to obtain a protective order or peace order, whichever is applicable to the situation. This is in addition to providing information on how to obtain the ERPO.

#### 4-234.4 LAW ENFORCEMENT RESPONSE

Any time an officer has a reasonable belief that an individual poses an **immediate** and **present** danger of causing personal injury to themselves or to other persons by possessing a firearm, the officer shall investigate the circumstances to determine whether an ERPO is appropriate. Qualifying incidents would include, but are not limited to:

- Domestic / family violence or disputes,
- Neighborhood disputes,
- Threats and harassment complaints,
- Threats of mass violence,
- Suicidal subject calls,
- Threats against law enforcement or other governmental entities, and
- Any call involving violence or threats of violence with a firearm.

If the investigation determines the individual does pose such a danger, the investigating officer shall immediately notify a supervisor and request they respond to the scene. The officer shall also make a determination as to whether the complainant meets the criteria to be eligible to petition the court for an ERPO. In either event, this investigation shall be documented on an incident report.

Once it is determined that petitioning for an ERPO is appropriate, the investigating officer should make a good faith and legal effort to secure firearms and ammunition in the Respondent's possession during the original call for service. This action should result in an effort to eliminate the potential harm and the need to secure the weapons and ammunition at a later time once the ERPO is issued. If the ERPO is not issued or the petition is subsequently dismissed, the weapons and ammunition can be returned to the lawful owner if the individual is not prohibited from possessing the firearms and ammunition by state or federal law.

#### Complainant Qualifies as the Petitioner:

For instances in which the complainant is eligible to be a petitioner, the officer shall explain to the person what an



## Administrative and Operational Manual

September 12, 2022

ERPO is and the process to obtain the interim or temporary order as is appropriate. Officers shall provide the complainant with the ERPO pamphlet which explains the process for the filing of the petition.

In most cases the complainant is in the best position to obtain the ERPO since the complainant has the necessary background information regarding the respondent's behavior and the specific facts and any relevant supporting facts and information. For this reason, the officer shall encourage the complainant to immediately respond to the District Court in order to obtain a Temporary ERPO or the District Court Commissioner's Office to obtain an Interim ERPO if the courts are not open. The officer will provide transportation to the complainant if necessary.

It is always the supervisor's discretion, even in cases where the complainant qualifies to file the ERPO petition, to initiate the filing of a petition by an officer. If the complainant indicates that they will not be pursuing an ERPO, the supervisor should determine whether it is appropriate for an officer to file the petition. In instances in which the complainant qualifies to be the petitioner, however the respondent poses an immediate and present danger to the general public, the supervisor shall initiate the filing of a petition by an officer.

**Process for Filing an ERPO Petition by an Officer:**

This section describes the procedure to be followed if the supervisor believes the circumstances warrant the filing of an ERPO petition by an officer.

Unless circumstances require the *immediate* filing of a petition, the supervisor will contact the General Counsel prior to the filing of a petition. Based on the information provided, the General Counsel will determine whether an interim, temporary, or no petition should be filed.

If the decision is made to file a petition, the supervisor will designate an officer to be the petitioner. The petitioner will also assume the responsibility of primary investigator for the ERPO and will conduct the investigation as directed by the Office of General Counsel. The Office of General Counsel will assist the petitioner in drafting the petition.

Upon receiving the ERPO from the Court or the Commissioner, the petitioning officer shall immediately turn the order over to the Commander of the Judicial Services Section for service. If the Judicial Services Commander is not available, the officer will turn the order over to the on-duty shift commander, who will then arrange for service. The order will also be entered into the computer systems as required elsewhere in policy. In addition to providing the commander the order, the officer shall also brief the commander of the circumstances surrounding the order and any noteworthy information to assist with the order being served. The serving officer will notify the Office of General Counsel that the ERPO has been served and provide a summary of what occurred during service.

In the event the General Counsel is not available, the decision to file a petition may be made by a lieutenant or above. The General Counsel will be notified as soon as possible that a petition was filed.

**Petitions for Emergency Evaluations:**

If an officer has an encounter with a subject which results in the officer either taking the person into custody for an involuntary emergency evaluation or assisting the person with a voluntary evaluation, the officer will determine if the subject poses an **immediate** and **present** danger to themselves or another by possessing a firearm. If not, the officer will document their findings on an incident report or make the appropriate notation on the event sheet if no report is required. If the subject does pose such a danger, the officer shall document their findings on an incident report and shall petition for an ERPO based on those facts.

**4-234.5 REPORTING REQUIREMENTS**

Officers responding to any call for service of a violent nature or a threat of violence shall determine if the incident qualifies for the issuance of an ERPO. If the incident did not qualify, the officer shall make that part of the disposition



Administrative and Operational Manual

September 12, 2022

of the call.

If the officer determines there is justification for the issuance of an ERPO, the officer shall note that in the disposition of the call. If the incident qualifies for the officer to create an incident report, their investigation related to the ERPO will be documented in that report. If there is no other need for an incident report, one will be generated to document the investigation relative to the need for an ERPO.

An ERPO pamphlet will be given to the complainant by the officer handling any incident involving violence or a threat of violence handled, whether the incident qualified for an ERPO or not. The issuance of the pamphlet shall be documented in disposition of the call as well as in the officer's incident report.

#### **4-234.6 COURT PROCEEDINGS**

An officer who files a petition for an ERPO does so in the officer's capacity as a member of the Charles County Sheriff's Office. Ultimate decision making authority to proceed or not proceed with an ERPO rests with the Sheriff and not with the petitioning officer. Attorneys with the Office of General Counsel are designated by the Sheriff to make decisions regarding ERPOs on the Sheriff's behalf.

The Office of General Counsel will handle all court matters regarding ERPOs on behalf of the Sheriff unless the Office of General Counsel is not available for anticipated court hearings or some other reason prevents representation. The Office of General Counsel will coordinate the service of court subpoenas with Judicial Services.

The officer filing the petition and obtaining an ERPO shall appear for all court appearances as directed by the Office of General Counsel. In the event an officer receives notice of other court action, such as an appeal, the officer shall send that notice to the Office of the General Counsel.

If the Office of General Counsel is unavailable to handle the court matters, it will be the officer-petitioner's responsibility to ensure the witnesses are made aware of all court dates and stress the importance of their appearance to ensure an order is continued.

The officer-petitioner must also obtain subpoenas for witnesses through the District Court Clerk's Office. Subpoenas shall be obtained for all necessary witnesses to compel them to attend the hearing for the Final ERPO. Any subpoenas obtained by the officer will be given to the Judicial Services Section Commander for service. As available, the Office of General Counsel will provide advice to the petitioner about the court proceeding.

#### **4-234.7 SERVICE OF INTERIM AND TEMPORARY ERPO ORDERS - CITIZENS ERPOS**

When the Agency receives a copy of an Interim or Temporary ERPO for service during business hours, the order shall be processed in the Judicial Services Section and assigned to an officer for service. If the Agency receives an Interim or Temporary ERPO for service after hours, the ERPO will be given to a Shift Commander, who shall assign the order to an officer for service. The officer shall immediately attempt to serve the order on the respondent.

In the event the Agency receives an ERPO for service on an individual not residing in this County, the officer receiving the ERPO will immediately forward an electronic copy of the ERPO (to be followed by a hard copy to be mailed) to the designated law enforcement agency for the jurisdiction in which the respondent resides.

Upon receiving any ERPO for service on the respondent or a copy which was served on the Sheriff's Office, the Judicial Services Section shall enter the order into the Sheriff's RMS system as well as METERS, or update the order if previously entered. If after hours, the District 1 Police Station Technician shall be responsible for entering



Administrative and Operational Manual

September 12, 2022

/ updating the order into both RMS and METERS.

In the case of an interim order, the Agency will send a return of service to the District Court Clerk's Office.

Within 2 hours after service of all ERPO, the Agency will electronically notify the Department of Public Safety and Correctional Services of the service using an electronic system approved and provided by the Department of Public Safety and Correctional Services.

The service of the ERPO and any subsequent firearms and ammunition recovery based on the order will be documented on a supplemental report to the original incident. This will be the responsibility of the officer serving the order and/or recovering the firearms and ammunition. If there is no original report, the serving / seizing officer will create an incident report for the event.

**Referrals to Law Enforcement for Emergency Evaluation on an ERPO**

**Interim Order:** A court commissioner may make a referral on the order that he/she finds, based upon the information contained within the petition, there is probable cause to believe the respondent meets the requirement for an emergency evaluation under Title 10, Subtitle 6 of the Health General Article. A referral notation on the order in and of itself does not provide law enforcement the legal authority to take the respondent into custody for an evaluation. It is a finding by the commissioner for law enforcement to make a determination as to whether the respondent should be taken into custody for an emergency evaluation.

**Temporary / Final Orders:** A judge may make a notation on the order that he/she finds, based upon the information contained within the petition, there is probable cause to believe the respondent meets the requirement for an emergency evaluation under Title 10, Subtitle 6 of the Health General Article. The judge will then cause a separate order to be issued directing law enforcement to take the respondent into custody and transport him/her to the nearest emergency facility for an examination by a physician. If the petitioner is an officer, the judge must be informed if an emergency petition was already completed and/or if the respondent is in the custody of the Detention Center.

**4-234.8 SEIZING FIREARMS AND AMMUNITION UNDER AN ERPO**

Upon serving an Interim or Temporary ERPO or upon coming into the possession of a Final ERPO, officers shall make a good faith effort to secure all firearms and ammunitions in the possession of the respondent.

- Upon receiving an ERPO for service, the serving officer shall review the document to determine what firearms should be in the respondent's possession. Additionally, the officer shall conduct a Maryland Gun database search on the respondent to determine what, if any, regulated firearms the respondent has registered to them in Maryland. This search will not identify unregulated firearms such as most rifles or shotguns and will not identify any ammunition in the respondent's possession.
- Upon serving an Interim, Temporary, or Final ERPO, the officer will order the respondent to surrender any and all firearms in their possession. If the officer believes the respondent is not fully cooperating, the officer may request consent to search for the firearms or may make application for a search and seizure warrant to attempt to locate the firearms. This will be the responsibility of the officer serving the order.
- **Consent Search:** Although every situation is different, officers may develop information that firearms and/or ammunition are in the possession of the petitioner or other individuals. In this case, the petitioner or other individuals may have the legal authority to give consent to the officers and allow officers access into the home or other locations to secure any firearms and/or ammunition. The respondent may also have the legal authority to give officers consent to search the home or other location.



Administrative and Operational Manual

September 12, 2022

- **Search Warrant:** Officers, during their investigations of the initial call or while attempting to obtain the firearms and/or ammunition in the service of the ERPO, may develop probable cause to apply to the court for an Order to search a specific location or locations in situations where the respondent has failed to surrender firearms and/or ammunition. Officers shall make all reasonable efforts to obtain the firearms and/or ammunition regarding the service of an ERPO

#### 4-234.9 RESPONSIBILITY UPON TAKING POSSESSION OF FIREARMS AND AMMUNITION

Officers or other Agency personnel coming into possession of firearms and/or ammunition in accordance with an ERPO shall at the time of surrender or seizure:

- Issue the respondent a Firearms / Ammunition Receipt (CCSO Form #198) to the respondent identifying the make, model, caliber, serial number, and condition of all firearms and ammunition seized or surrendered as a result of an ERPO;
- Attach a copy of the receipt to the incident report;
- Provide information to the respondent on the process for retaking possession of the firearms and/or ammunition on the expiration or termination of the Order;
- All firearms shall be photographed and placed in a protective case if available. Officers or other personnel shall not place any marks on the firearms for identification or other purposes.
- Complete a property held sheet and place the firearms / ammunition in Property Held in accordance with current recovered firearms procedures.

#### 4-234.10 EXPIRATION OF THE ERPO

Upon the expiration or termination of an ERPO, the Agency shall:

- Notify the respondent they may request the return of the firearms and/or ammunition;
- Before releasing firearms and/or ammunition to the respondent, verify that the respondent is not otherwise prohibited from possessing firearms and/or ammunition.
- On request of the respondent who is not otherwise prohibited from possessing firearms and/or ammunition, the Agency shall return the firearms and/or ammunition to the respondent no later than:
  - 14 days after the expiration of an Interim or Temporary Order; or
  - 14 days after the court terminates a Final Order;
  - 48 hours after the expiration of the Final Order.

A respondent who does not wish to recover firearms and/or ammunition or who is otherwise prohibited from possessing firearms and/or ammunition may sell or transfer the firearms and/or ammunition to:

- A Federal Firearms Licensed Dealer (the FFL must provide written proof that the respondent has agreed to transfer the firearms and/or ammunition to the dealer and this Agreement must be verified with the respondent and the verification documented in writing);



Administrative and Operational Manual

September 12, 2022

- Another person who is not prohibited from possessing the firearms and/or ammunition under State and/or Federal Law and who does not reside in the same residence as the respondent (the person must provide written proof that the respondent has agreed to transfer the firearms and/or ammunition to the person and the Agreement must be verified with the respondent and the verification documented in writing);

A respondent may request the Agency destroy the firearms and/or ammunition.

If an individual other than the respondent claims ownership of a firearm and/or ammunition surrendered or seized as a result of an ERPO, the Agency shall only release the firearm and/or ammunition to the individual if:

- The individual provides proof of ownership of the firearm and/or ammunition; and
- The Agency determines the individual is not otherwise prohibited from possessing the firearm and/or ammunition.

In the event a firearm and/or ammunition is not reclaimed within 6 months after the notice to a respondent, no party shall have the right to assert ownership of the firearm or ammunition, and the Agency may destroy the firearm and/or the ammunition.

#### 4-234.11 VIOLATIONS OF AN ERPO

Violations of the conditions of an ERPO are a misdemeanor and punishable by imprisonment of up to 90 days for the first offense and 1 year for subsequent offenses. Officers **shall arrest** with or without an arrest warrant any person whom the officer has probable cause to believe is in violation of an Interim, Temporary, or Final ERPO in effect at the time of the violation.

#### 4-234.12 TRANSFER OF FIREARMS UPON CONVICTION OF DOMESTICALLY RELATED CRIME

When a defendant is convicted of or pleads guilty to a disqualifying crime that the court determines to be a domestically related crime, the court shall inform the defendant that the defendant is prohibited from possessing a regulated firearm, a rifle, or a shotgun as defined by Maryland law. The court shall also order the defendant to transfer all regulated firearms, rifles, or shotguns owned by the defendant or in the defendant's possession.

By law the transfer of the regulated firearms, rifles, or shotguns shall be made within two business days after the conviction or guilty plea. The Defendant must surrender their firearms to a state or local law enforcement agency or to a federally licensed firearms dealer. The defendant ordered to surrender the firearms may designate a representative to transfer the firearms to a state or local law enforcement agency or to a federally licensed firearms dealer.

#### 4-234.13 RECEIVING TRANSFERRED FIREARMS

The law enforcement agency or federally licensed firearms dealer accepting a transferred firearm under this law shall issue a written proof of transfer to the person transferring the firearm. The CCSO Firearms Transfer Report (CCSO form #356) will be used for firearms turned into the CCSO under this section.

Officers receiving the firearms transferred under this law shall follow all other property procedures for recovered firearms located in section 4-500 of the AOM. The CCSO Firearms Transfer Report and a copy of the court order will be attached to the required property report.

#### 4-234.14 COMPLIANCE WITH THE COURT ORDER



**Administrative and Operational Manual****September 12, 2022**

Charles County Courts will make notification to the Charles County Sheriff's Office that a defendant has been ordered to transfer their firearms. The supervisor of the Domestic Violence Unit shall review all court notifications and will determine if the named defendant resides in Charles County. If so, the supervisor will check to determine if the defendant, or their designee, have transferred their firearms to the CCSO or the federally licensed firearms dealer as required by the court order. If the defendant has not surrendered their firearms, the supervisor shall cause an investigation to be conducted to determine if the defendant is in violation of the court's order. If it is determined that the defendant is in violation, the case will be forwarded to the Narcotics Enforcement Section's ATF task force member for follow up.

If the Domestic Violence Supervisor determines the defendant resides outside of Charles County, the supervisor will immediately forward an electronic copy of the court order (to be followed by a hard copy to be mailed) to the designated law enforcement agency for the jurisdiction in which the defendant resides. Likewise, any order received by the CCSO from another jurisdiction will be handled by the Domestic Violence Supervisor in the same manner as an order received from the court.

**4-234.15 REPORTING REQUIREMENTS**

Any and all investigative steps completed after receiving a court notification of a conviction will be documented in an incident report. Even in the event an order is sent for service outside of Charles County, an incident report will be completed documenting which agency it was sent to. If the defendant complies with the order and surrenders his firearms to this agency, the Firearms Transfer Report will be attached to a Property Report which will fulfill the reporting requirement for this section. A separate incident report will not be needed unless there is additional investigation required.

**4-234.16 SEARCH WARRANTS**

Upon probable cause to believe the defendant has failed to surrender one or more regulated firearms, rifles, or shotguns, in accordance with the court order the defendant may be guilty of possession of a regulated firearm under section 5-133 or a rifle and or shotgun under sections 5-205 or 5-206 of Maryland Public Safety Article. An officer may make application for a search and seizure warrant for the removal of any regulated firearm, rifle or shotgun at any location where there is probable cause to believe a firearm owned or possessed by the defendant is located.

**4-234.17 STORAGE OF TRANSFERRED FIREARMS**

Any firearms received as the result of a court order based on the conviction of a domestically related crime shall be retained by the CCSO Property Management Section until such time as all possibilities of an appeal have been exhausted. Once the appeals have been exhausted, any firearms received by CCSO based on this court order is subject to disposition and will be disposed of by the Property Management Section in accordance with existing policies related to the disposition of firearms.

**4-235 STOP AND FRISK**

A person may be stopped by a police officer upon a specifically based reasonable suspicion that the person has committed, is committing, or is about to commit, a crime. Reasonable suspicion is more than a "hunch" but less than evidence which amounts to probable cause to arrest a person. The factual circumstances of each case will dictate the reasonableness of the stop and frisk. The following circumstances may be considered by the police officer in determining whether reasonable suspicion exists, thereby justifying a stop. This list is not intended to be all-inclusive:

- Observation of unusual conduct and actions of the person;



Administrative and Operational Manual

September 12, 2022

- 
- Appearance or demeanor of the person;
  - The time of day;
  - The location;
  - The clothing of the person (e.g., any suspicious bulges appearing through the person's clothing);
  - Whether the person is carrying anything and, if so, the nature thereof;
  - Proximity to a known crime scene;
  - Prior knowledge of the officer, including the person's prior records and any other information obtained relating to the person and their conduct;
  - Information obtained from citizens or other officers.

Once sufficient reasonable suspicion is established and the officer decides to initiate a stop, the officer:

- must announce their status as a police officer; and
- may request the person's identification; and
- may request the person's license and vehicle registration if the person is in a vehicle; and
- may question the person to determine if they are armed with a weapon; and
- may conduct a frisk of the individual if the officer has reasonable suspicion to believe the person may be armed and presently dangerous to the officer or others.

The officer may decide to frisk an individual they have stopped based on the officer's observations, information, and experience, and if the officer reasonably believes that:

- the person may be wearing, carrying, or transporting a weapon; and
- the person poses a threat to the officer or others; and
- it is impractical to obtain a search warrant; and
- to protect the officer or others, swift measures are necessary to discover whether the person is armed.

Both the stop and the frisk must be supported by reasonable and articulable suspicion to suspect criminal activity.

If a frisk is justified, it must be limited to a "patting down" of the outside of the person's clothing solely to determine if the person is carrying a weapon. If the frisk fails to identify any evidence of a suspected weapon, no further search is permissible. However, if during the frisk, the officer discovers an object which is readily apparent to the officer to be a weapon, the officer is authorized to search that part of the person's clothing containing the object, but may not search further.

If the object felt and found in the course of the search is in fact a dangerous or deadly weapon, and the evidence is that the possession thereof is in violation of law, the officer may then and there arrest the person for a crime committed in his presence. As incident to such lawful arrest, the officer may make a further search of the person and his immediate surroundings and seize anything in the nature of contraband, evidence, or fruits of the crime.

If, after the frisk and then subsequent search, the object believed to have been a weapon is actually found to be an item of contraband or evidence of a crime, the object may nonetheless be seized and the person may be arrested.

If, during the initial frisk, it is readily apparent to the officer that the object felt is not a weapon, but is contraband, the object may be retrieved and if the object is in fact contraband, it may be seized and the person may be arrested. During the frisk, the immediate identification of the contraband must be made without squeezing, moving, or other manipulation of the object by the officer.



## Administrative and Operational Manual

September 12, 2022

#### 4-235.1 REPORTING

Any officer who conducts a stop and frisk shall document the circumstances surrounding the incident by completing a Field Interview Report (Form #389) with the first line in the narrative section stating "Stop and Frisk." The officer shall also be responsible for completing any associated incident or arrest reports related to the stop and frisk. The FIR must be completed within 24 hours of the event.

The FIR shall include the following information at a minimum:

- Name, race, and DOB of the person;
- Date, time, and location of the incident;
- A description of the circumstances surrounding the stop and frisk, including the officer's reasonable suspicion;
- Whether any items were recovered and if so, a description of the items.

The officer shall print and forward a hard copy of the completed FIR to the Records Section. It will then be forwarded by the Records Section to the Maryland State Police.

#### 4-236 MISSING PERSON CASES AND REPORTING

CCSO will dispatch an officer to all reports of a missing person and thoroughly investigate all such reports. Officers will initiate Missing Person Reports following the procedures outlined in this section of the AOM. State of Maryland Form #79 will be used to record all missing person investigations.

There is no age limit or time period a person must have been missing for the Agency to initiate a Missing Person Report and investigation. In accordance with CJIS policy, all missing person reports will be entered into the National Crime Information Center (NCIC) and METERS computer network within 2 hours after receipt of the minimum information necessary to make the entry. Each missing person will need their own incident report number, so the entry into NCIC and METERS can be tracked properly. For example, when taking a report for multiple persons missing from the same location, each person needs a separate incident report number and report completed.

Initial Missing Person Reports will contain, at a minimum, the physical description, clothing description if known, vehicle description if applicable, circumstances of disappearance, and all investigative steps taken to locate the missing person.

In all critical missing person, child abduction, and unidentified found child cases, a supervisor, the Search Management Function, and CID will be notified. In critical cases where the missing person is not located during the initial investigation and search or where a found child cannot be readily identified, CID will be responsible for the follow-up investigation. In child abduction cases that meet the required criteria, CID will be responsible for activation of the Maryland Amber Plan.

In cases of persons having cognitive disorders, particularly the elderly or those with Alzheimer's Disease, the Silver Alert Program will be initiated in those cases where the required criteria are met. CID will be responsible for coordinating the activation of the Silver Alert Program.

#### 4-236.1 DEFINITIONS

**Adult** - a person 18 years of age or older.

**Abduction** - a person taken by an unknown individual, through force or persuasion, usually in furtherance of



Administrative and Operational Manual

September 12, 2022

additional victimization or when a non-custodial family member flees with a child, usually in direct violation of a court ordered custody arrangement.

**Critical Missing Person** - a missing individual whose circumstances require an increased response.

**Maryland Amber Plan** - a cooperative partnership between law enforcement, the broadcast media, and other agencies for the immediate communication of vital information about a serious child abduction to as wide an audience as possible.

**Maryland Silver Alert Program** - a coordinated notification plan that is activated when certain criteria are met involving a missing person with a cognitive disorder, generally the elderly or a person with Alzheimer's Disease.

**Missing Adult** – means a person who is:

- 18 years old or older; and,
- Whose disappearance is not voluntary; or,
- A person is absent from their accustomed network of social and personal relationships to the extent that people within that network define the absence as a reason for concern for the health or welfare of the person.

A missing adult is considered **CRITICAL** when meeting one or more of the following criteria:

- Is 75 years old or older;
- Has a cognitive disorder or intellectual developmental disability;
- Has a known or suspected serious injury, illness, or physical handicap;
- Is currently suicidal;
- Is missing following a catastrophic event;
- And/or foul play is suspected.

**Missing Child** – means a person who is:

- under the age of 18 years; and,
- the subject of a Missing Person Report filed with a law enforcement agency in this state and whose whereabouts are unknown.

A missing child is considered **CRITICAL** when meeting one or more of the following criteria:

- Suffers from a mental or physical handicap or illness;
- Has a cognitive or intellectual developmental disability;
- Has been the subject of a child abuse report;
- A child under 8 years of age, who generally has not established independence from parental control and who does not have the survival skills necessary to protect themselves from exploitation;
- Is missing following a catastrophic event;
- The disappearance is of a suspicious or dangerous nature;
- The person filing the report of a missing child has reason to believe that the missing child has been abducted.

All children are considered missing upon receipt of a complaint, and a report will be taken.

**Runaway** - a child, most often a teenager, who leaves home voluntarily for a variety of reasons.

**Search Management Function** – Group of Agency members specifically trained in techniques like Lost Persons



Administrative and Operational Manual

September 12, 2022

Behavior used to assist in locating a missing person.

**Throwaway Child** - a child whose caretaker makes no effort to recover the child who has run away or who has been abandoned or deserted.

**Unidentified Person** - a found person, whether living or deceased, who cannot be readily identified.

#### 4-236.2 SEARCH MANAGEMENT FUNCTION (TEAM)

The Search Management Team, assigned to the School Resources Section of SOD, is a group of collateral duty officers specifically trained to manage search activities surrounding critical missing persons, manhunts, and large scale catastrophes. Using the scientific principles of Lost Person Theory, specialized management training, and best practices developed in conjunction with regional partners from the Council of Governments, search managers utilize the appropriate resources to locate the search subject as quickly as possible while balancing the safety of the search teams and other organizational considerations.

#### 4-236.3 COMMUNICATIONS SECTION RESPONSIBILITIES

Call takers, upon receiving the report of a missing person, will be responsible for:

- obtaining as much information as possible to make an initial determination about what type of missing person is being reported (i.e., child, adult, critical);
- obtaining an initial description for the missing person, or vehicle(s) involved, and in the case of abduction, any suspect descriptions; and
- entering the call information into the CAD system immediately to facilitate a police response.

Police Communication Officers (PCOs) will be responsible for:

- immediately dispatching an officer to the scene of the report and informing the officer about any look-out obtained;
- notifying the appropriate supervisor of all potential critical missing person cases; and
- broadcasting the initial and subsequent descriptions obtained and making other notifications as requested.

#### 4-236.4 RESPONDING OFFICER'S RESPONSIBILITIES - CRITICAL MISSING

In responding to critical missing person cases, officers are, as circumstances dictate, responsible for:

- obtaining information from the complainant and completing the Missing Person Report (SOM Form #79);
- completing the Search Urgency Evaluation Form (CCSO Form #297);
- establishing the Point Last Seen (PLS), a key component for additional searching;
- conducting a thorough search of the location where the missing person was last scene, especially if that location is a structure. Children will often hide within a building as if playing a game;
- supplying Communications with lookout information and following up on any locations where the missing person may be located, with the assistance of additional responding officers if necessary;
- facilitating entry of all necessary and available information into the METERS / NCIC computer networks within 2 hours as required by law.

#### 4-236.5 SUPERVISOR'S RESPONSIBILITIES - CRITICAL MISSING

In responding to critical missing person cases, supervisors are, as circumstances dictate, responsible for:

- obtaining a briefing and ensuring all required written reports are completed;



**Administrative and Operational Manual**

**September 12, 2022**

- review of the Search Urgency Evaluation Form and comparing incident to defined critical missing person;
- responding to the determination of score on the Search Urgency Form, by either determining no additional resources or consultation is necessary, or by contacting the appropriate Patrol Commander to respond and take command of the incident;
- ensuring entry or removal of all necessary and available information into the METERS / NCIC computer networks.

#### **4-236.6 COMMANDER'S RESPONSIBILITIES – CRITICAL MISSING**

In responding to critical missing person cases, commanders are, as circumstances dictate, responsible for:

- obtaining a briefing and ensuring all required written reports are completed;
- reviewing the Search Urgency Evaluation Form;
- contacting the on-call Search Manager for a consultation;
- establishing a command post and staging area for any missing person search mission;
- serving as the overall incident commander and facilitating the ICS process for CCSO and serving in the Unified Command, if necessary;
- utilizing available Patrol resources to conduct hasty searches in the immediate search area or at locations where the missing person may be located prior to Search Management's arrival;
- ensuring entry or removal of all necessary and available information into the METERS / NCIC computer networks.

#### **4-236.7 SEARCH MANAGEMENT FUNCTION – RESPONSIBILITIES**

In responding to critical missing person cases, search managers, as circumstances dictate, are responsible for:

- responding to the command post for a critical missing person incident;
- determining the assets necessary to conduct the search, to include K-9, drones, etc., and facilitating their response;
- filling the position of Operations Chief in the ICS structure;
- determining the operations area of the search mission;
- establishing work objectives for responding resources to locate the missing person;
- advising the incident commander on operations length, scope, and area of operations;
- approving all out-of-county law enforcement personnel or non-governmental organization responses;
- incorporating CID detective into operations work group to facilitate information sharing;
- facilitating all of the paperwork required to conduct the search.

#### **4-236.8 CID RESPONSIBILITIES – CRITICAL MISSING**

In responding to critical missing person cases, CID personnel are, as circumstances dictate, responsible for:

- responding to the scene of all critical missing person cases;
- assuming investigative responsibility for the incident;
- gathering information about recent family history;
- interviewing parent(s) / reporting person(s) and all witnesses, and reconciling any conflicting information;
- reviewing and evaluating all available information and evidence collected;
- developing an investigative plan for follow-ups;
- determining if additional investigative resources or specialized services are required;
- making required entries, updates, and cancellations in METERS / NCIC;
- ensuring the AMBER Plan / Silver Alert is activated where required;



Administrative and Operational Manual

September 12, 2022

- in coordination with Homeland Security and Intelligence Section and the Media Relations Officer, creating missing person bulletins / flyers with photographs and descriptive information;
- securing missing person's latest medical and dental records;
- establishing a telephone hotline for receipt of tips and leads;
- assigning detective as liaison to the Search Management Team; and
- executing the investigative follow-up plan.

#### 4-236.9 PRELIMINARY INVESTIGATION CHECKLIST FOR CRITICAL MISSING PERSONS

This checklist is adapted from a list prepared by the National Center for Missing and Exploited Children and is meant to provide a framework for considerations and actions for CCSO when investigating critical missing person cases. During the preliminary investigation of critical missing persons, officers will, as circumstances dictate:

- interview parent(s) / person making the initial report;
- verify that the critical missing person is, in fact, missing;
- if missing person is a child, verify the custody status;
- identify the circumstances of the disappearance;
- complete the Search Urgency Form (#297);
- request a supervisor to respond if necessary;
- obtain and note permission to search home or building where incident took place;
- conduct an immediate, thorough search of the missing person's home, even if the missing person was reported missing from a different location;
- determine when, where, and by whom the critical missing person was last seen;
- interview the individuals who last had contact with the critical missing person;
- obtain a detailed description of the critical missing person, abductor, and any vehicles used;
- relay detailed descriptive information to Communications for broadcast updates;
- brief and bring up-to-date all additional responding personnel, including supervisors and investigative personnel;
- ensure that all persons at the scene are identified and interviewed separately and that their interview and identifying information is properly recorded;
- determine relationship to the critical missing person of each person present;
- note information that each person may have about the critical missing person's disappearance;
- determine when / where each person last saw the critical missing person and ask each one, "What do you think happened to the critical missing person?"
- obtain names / addresses / telephone numbers of critical missing person's friends / associates and other relatives and friends of the family;
- continue to keep Communications apprised of all appropriate developing information for broadcast updates;
- treat the area as a crime scene and protect the scene and area of the critical missing person's home (including personal articles such as hairbrush, diary, photographs, and items with the critical missing person's fingerprints / footprints / teeth impressions) so that evidence is not destroyed;
- determine if any of the critical missing person's personal items are missing;
- evaluate contents and appearance of the critical missing person's room / residence;
- obtain photographs / videotapes of critical missing person / abductor;
- ensure that information regarding the missing person is entered into METERS / NCIC missing person file and that any information on a suspected abductor is entered into the NCIC wanted person file (carefully review NCIC categories before entering the case, and be sure to utilize the child abduction flag whenever possible); and
- complete all required reports.



Administrative and Operational Manual

September 12, 2022

#### 4-236.10 NON-CRITICAL MISSING PERSON CASES

Officers assigned responsibility for investigation of cases not meeting the definition for critical missing person incidents will:

- seek to determine the circumstances surrounding the disappearance;
- verify that the person is, in fact, missing by conducting a thorough check of the home;
- initiate a Missing Person Report;
- search the immediate area;
- check peers' congregation locations;
- contact friends and/or relatives;
- provide Communications with any updated lookout;
- submit the Missing Person Report and any supplement(s) to their immediate supervisor, who is responsible for entry and/or removal of the missing person in the METERS / NCIC missing person network, according to their guidelines; and
- contact the complainant and submit a supplement every 72 hours, until the missing person is located, or until the case is reassigned to CID for follow up.

After ten (10) days from the date of the initial report, the case will be forwarded to the Criminal Investigations Division. CID investigators will then assume responsibility for subsequent follow-up search, investigation, and updates to METERS / NCIC. Prior to forwarding the case to CID, the original investigating officer will contact the complainant and verify the individual is still missing.

#### 4-236.11 UNIDENTIFIED PERSON CASES

All cases of unidentified persons, whether living or deceased, where identity cannot be established during the preliminary investigation, will be turned over for investigation to CID. CID will be responsible for entering all available information into the NCIC Unidentified Person File and for canceling all notifications after identification is confirmed.

#### 4-236.12 ACTIVATION OF THE MARYLAND AMBER PLAN

The Maryland Amber Plan is a cooperative partnership between law enforcement, the broadcast media, and other agencies for the immediate communication of vital information about a serious child abduction to as wide an audience as possible. In Maryland, this partnership includes local law enforcement, the Maryland State Police, the Maryland Department of Transportation, area broadcasters' associations, cable telecommunications' associations, the Maryland Emergency Management Agency, and the Maryland Center for Missing Children.

The Maryland Amber Plan will be set in motion by the Maryland State Police, only upon a request made by a law enforcement agency. Law enforcement agencies making such requests must first determine that the following criteria exist:

- law enforcement verifies that a child has been abducted;
- law enforcement believes the circumstances surrounding the abduction indicate the child is in serious danger of bodily harm or death;
- there is enough descriptive information about the child, abductor, or a suspect vehicle to believe an immediate broadcast alert would aid in locating the child; and
- the abductor and/or child are likely to still be in the broadcast area.

Unless an investigating agency can articulate a reasonable suspicion that a parent intends to physically harm a child, abduction by a non-custodial parent is not a case which would routinely meet the Maryland Amber Plan





**Administrative and Operational Manual**

**September 12, 2022**

criteria.

A member of CID will review the circumstances regarding the case and, if satisfied that the criteria are met, will contact the Maryland State Police Headquarters' Duty Officer and request that the Maryland Amber Plan be activated. Contact with the Duty Officer may be made by telephone, fax, or through the METERS teletype.

After making an initial notification to the MSP Duty Officer, the requesting agency will be immediately contacted by the designated Amber Plan coordinator from either the MSP Criminal Enforcement Command or the Maryland Center for Missing Children (MCMC). The coordinator will review all requests to ensure they meet the established criteria. When abduction is confirmed and it meets all points for activation of the Plan, MSP will:

- enter the necessary information into the designated web site or authorize the reporting agency to do so;
- notify the Maryland / DC Emergency Activation System (EAS) stations by telephone and fax of the activation of the Plan and provide the necessary information for broadcast;
- notify the Maryland Department of Transportation, State Highway Administration, and the Statewide Operations Center (SOC) of the activation of the Plan and provide the necessary information for display on the Dynamic Message Signs (DMS) and broadcast over the Highway Advisory Radios (HAR).

Upon notification, EAS stations will broadcast a civil emergency / child abduction message to all media outlets. Participating media outlets will then broadcast the lookout to the public. The SOC will display the lookout information on the DMS and broadcast the information over the HAR. They will contact the Maryland Transportation Authority to display the information on the DMS signs.

EAS stations will, as programming permits, broadcast alerts four times per hour for the first two hours. They will then continue with three broadcasts per hour for the next three hours. Updated alerts may be broadcast if significant new information is developed or if a child is located. Alerts are self-canceling after 24 hours.

Broadcast alerts conclude with a statement that any person(s) who may locate the abductor or vehicle should take no action other than to call 911 as soon as possible and provide law enforcement with the location.

For any missing child who has not been located within twenty-four (24) hours of the filing of the initial Missing Person Report, where there is reason to believe the person may be located in another jurisdiction, the Maryland State Police and Maryland Center for Missing Children shall be notified.

Notification will be made by CID by phone / fax and by Records Management, by forwarding a copy of the original report. In cooperation with the local agency, the MCMC will assist and coordinate in-state and national efforts to locate the missing child.

#### **4-236.13 ACTIVATION OF THE SILVER ALERT PROGRAM**

The Silver Alert is a public notification system in the United States to broadcast information about missing persons, especially senior citizens with Alzheimer's Disease, dementia, or other mental disabilities, in order to aid in their recovery.

When warranted, state or local police investigating a qualifying disappearance will contact the MSP Silver Alert coordinator. Upon confirming the Silver Alert criteria, the coordinator will contact the Maryland Emergency Management Agency and request an emergency alert. This alert is sent to all Maryland police departments, media outlets, and 911 centers. The State Highway Administration will display the alert on highway signs in the geographic area in which the missing person was last seen.

Only law enforcement agencies may request the issuance of a Silver Alert. Law enforcement agencies making such requests must first determine that the following criteria exist:



Administrative and Operational Manual

September 12, 2022

- The missing person is at least 60 years of age; and
- The missing person suffers a cognitive impairment, including a diagnosis of Alzheimer's Disease or dementia; and
- The missing person's disappearance poses a credible threat to the health and safety of the individual; and
- The missing person is traveling in a vehicle and there is enough descriptive information about the missing person and the vehicle for law enforcement to issue an alert; and
- The investigating agency has already activated a local or regional alert by contacting media outlets in their jurisdiction; and
- The missing person has been entered into the National Crime Information Center (NCIC).

The responsibility to activate the Silver Alert system rests with CID in qualifying cases.

#### 4-236.14 PROJECT LIFESAVER

Project Lifesaver is an electronic tracking system for individuals who may suffer from a mental disorder and easily become disoriented and lost. The tracking system uses an electronic transmitter attached by a wrist band or pendant to track a lost individual.

The CCSO provides this service to individuals who qualify based on an existing medical condition and who have exhibited a tendency to wander off from their residence and become lost.

The coordinator for Project Lifesaver is the supervisor of the Crime Prevention Unit of the Special Operations Division. Officers assigned as project operators may be selected from all areas of the Agency and must complete an operator certification course as well as maintain proficiency with the electronic equipment. Operators are subject to being called out anytime day or night in the event of a Project Lifesaver incident.

#### 4-237 SUSPENSION ROUTINE PATROL DUE TO ADVERSE WEATHER CONDITIONS

##### 4-237.1 GUIDELINES

When weather or road conditions become so adverse as to make routine patrol unduly hazardous, a sector supervisor may request authority from the district / shift commander to suspend routine patrol activities.

- The suspension of routine patrol may be implemented in conjunction with a state or county-wide snow emergency plan; however, either one may be implemented independently of the other.

If the district / shift commander grants the request he will notify Communications, who will broadcast suspension of routine patrol status to the affected sector.

- Suspension of routine patrol may also be requested during other major storms, such as hurricanes or tornadoes, and the flooding conditions that may accompany them.

Implementing suspension of routine patrol shall not limit police responses to emergencies or unusual calls for service which require personal police assistance. During this period, all calls which do not demand an on-scene police presence may be taken over the telephone.

The district / shift commander will assign one or more patrol or CID officers to station duty during the period of



Administrative and Operational Manual

September 12, 2022

suspension to facilitate telephone incident reporting.

The district / shift commander will ensure that all available personnel are utilized to their best advantage during a weather-related emergency. This may include the temporary reassignment of CID personnel to supplement or assist patrol officers until normal operations are resumed.

#### 4-237.2 CANCELLATION OF SUSPENSION OF ROUTINE PATROL

When the unfavorable weather conditions preceding the suspension of routine patrol cease to exist, a sector supervisor may request authority from the district / shift commander to cancel the suspension. The district / shift commander will direct the Communications Supervisor to notify all affected personnel to return to normal operations.

- The return to routine patrol may be implemented in conjunction with a cancellation of state / County-wide snow emergency plan; however, either one may be canceled independently of the other.

#### 4-238 YELLOW ALERT PROGRAM

The Yellow Alert Program was established by the Maryland State Police, as a requirement by the State of Maryland, to provide a system for rapid dissemination of information to assist in locating and apprehending a missing suspect who fails to remain at the scene of a traffic accident that might result in serious bodily injury or death.

##### 4-238.1 DEFINITIONS

**Missing Suspect:** an individual whose whereabouts are unknown, who is suspected of a violation of the Transportation Article relating to failing to remain at the scene of a traffic accident that might result in serious bodily injury or death, and whose vehicle the reporting law enforcement agency is able to describe, including any information about the vehicle's registration plate.

**Serious Bodily Injury:** an injury that creates a substantial risk of death; causes serious permanent or serious protracted disfigurement; causes serious permanent or serious protracted loss of the function of any body part, organ, or mental faculty; or causes serious permanent or serious protracted impairment of the function of any bodily member or organ.

##### 4-238.2 BACKGROUND

Maryland has a voluntary partnership between law enforcement agencies and broadcasters to activate an urgent bulletin in cases of critically missing juveniles (Amber Alerts), vulnerable adults (Silver Alerts), and serious attacks on law enforcement officers (Blue Alerts). Such alerts involve the use of the Emergency Alert System (EAS), State Highway Administration overhead Dynamic Message Signs, and notification to local 911 centers and the media to air a description of the known facts. Expanding on this partnership, and to assist in the investigation of certain hit and run accidents, Maryland has enacted a Yellow Alert Program.

##### 4-238.3 REQUESTING AN ALERT

Law enforcement agencies investigating hit and run accidents involving a missing suspect who fails to remain at the scene of a traffic accident that might result in serious bodily injury or death, will promptly request an activation of a Yellow Alert through the Maryland State Police Headquarters Duty Officer at (410) 653-4200. The request will be made at the direction of the investigating officer by the dispatch supervisor, the investigating officer, or their designee.

Yellow Alerts will be activated only when there is enough descriptive information about the missing suspect's vehicle



Administrative and Operational Manual

September 12, 2022

to enable law enforcement to assist in the suspect's apprehension.

A Yellow Alert will not be activated when releasing information to the media or public would compromise the integrity of the investigation.

#### **4-238.4 DEACTIVATING AN ALERT**

A law enforcement officer or agency that locates a missing suspect or vehicle that is the subject of a Yellow Alert will immediately notify the MSP Headquarters Duty Officer and the investigating law enforcement agency that the missing suspect or vehicle has been located.

If the missing suspect or vehicle has not been located within 24 hours, the alert is self-canceling.

### **4-239 POLICY CONCERNING DIPLOMATIC IMMUNITY**

#### **4-239.1 DIPLOMATIC IMMUNITY DEFINED**

Diplomatic immunity is an expression of reciprocal international courtesy, and it may be broadly defined as the immunities, rights, privileges, and exemptions accorded foreign governments, foreign ambassadors and other public ministers, and their families and members of their official household including secretarial, servant, and consular personnel in the United States. As official representatives of foreign governments, diplomats should be accorded the maximum degree of respect possible under whatever the circumstance may be. The police handling of incidents in this country may have a direct effect on the treatment of U.S. diplomats abroad.

Those persons with diplomatic immunity may not be arrested or imprisoned and their property shall not be searched or seized. This is qualified with the understanding that a host country does not give up its right to protect the safety and welfare of its populace and retains the right, in extraordinary circumstances, to prevent the commission of a crime. Thus, in circumstances where public safety is in imminent danger or a serious crime may be committed, police may intervene to the extent necessary to halt such activity. This naturally includes the power of the police to defend themselves from personal harm.

The U.S. Department of State, in many incidents involving persons with immunity, will request a waiver of that immunity if a local prosecutor advises that they would be willing to prosecute or otherwise pursue charges. If the charge is a felony or crime of violence, and the diplomat's home country does not waive immunity, the U.S. Department of State will require that person to depart the United States and not return, except to submit to the jurisdiction of the court. Upon the subject's departure from the U.S., a warrant may be issued and entered into NCIC.

#### **4-239.2 GENERAL PROCEDURES - CONTACTS WITH PERSONS CLAIMING DIPLOMATIC IMMUNITY**

The following procedures will be followed when handling an incident involving a person who claims diplomatic immunity:

- Request and verify identification. Individuals claiming immunity may be delayed until immunity is verified;
- If a diplomatic identification card or U.S. Department of State driver's license is presented, the officer shall, as soon as practicable, contact the U.S. Department of State to verify immunity or driver's status. Communications has current phone numbers for verifying information;
- If immunity is verified, record all necessary descriptive information, issue citations or other charging



**Administrative and Operational Manual**

**September 12, 2022**

documents as required, and immediately release the individual;

- In all cases the officer shall complete the appropriate report(s). Dependent on the circumstances, the officer should document the incident completely for possible prosecution at a later time. The terms “detained” or “detention” should be avoided and words such as “delayed” or “held for protection” should be used;
- A copy of all reports should be faxed or mailed to the U.S. Department of State as soon as possible. In serious cases, contact with the Department of State should also be made by telephone.

**4-239.3 ASSAULT ON OFFICER BY DIPLOMAT**

As with any ordinary citizen, when an individual enjoying diplomatic immunity commits an assault upon a police officer, the officer may use whatever force necessary to subdue the individual.

An arrest will not be made. However, the incident must be investigated by an officer’s immediate supervisor and properly documented on the appropriate report.

**4-239.4 VEHICLES WITH DIPLOMATIC TAGS OR OWNED BY INDIVIDUALS CLAIMING DIPLOMATIC IMMUNITY**

The property of a person enjoying full diplomatic immunity, including vehicles, may not be searched or seized. Such vehicles shall not be impounded, but may be towed the distance necessary to remove them from obstructing traffic or endangering public safety. If a vehicle owned by a diplomat is suspected of being stolen or involved in the commission of a crime, occupants shall be required to present identification and vehicle documentation. The vehicle’s status can be checked through NLETS. Should the vehicle prove to have been stolen or is being used by unauthorized persons in the commission of a crime, the inviolability to which the vehicle would normally be entitled must be considered temporarily suspended, and a normal search of the vehicle and, if appropriate, its detention, are permissible.

**4-239.5 GENERAL TRAFFIC ENFORCEMENT AND DIPLOMATIC IMMUNITY**

Stopping a diplomat and issuing a traffic citation does not constitute arrest or detention and is permissible. The violator’s signature on the citation may not be required. Accordingly, a police officer should never hesitate to follow normal procedures to intervene in a traffic violation which he or she has observed. Even if immunity ultimately bars any further action at the scene, the officer should take enforcement action against persons committing moving violations. If the person with diplomatic immunity refuses to sign a citation, the officer should write “Diplomat-Refused” on the citation, and provide a copy to the violator.

**4-239.6 MOVING VIOLATIONS AND SERIOUS TRAFFIC INCIDENTS**

The Maryland Transportation Article, (TR § 16-901 - 16-905) applies to an individual who displays a driver’s license issued by the U.S. Department of State or who otherwise claims immunity. The article applies to violations of Criminal Law, § 2-209, “manslaughter by vehicle or vessel”; § 2-503, “homicide by motor vehicle or vessel;” § 3-211, “life threatening injury;” and DWI / DUIs, and all other moving violations.

Officers handling such incidents should proceed as they normally would, short of making a physical arrest. Sobriety tests, including a PBT, may be offered, but may not be required or compelled. The officer should issue the appropriate citation, and complete the appropriate report and any other paperwork related to the case.

If the officer determines that the individual’s ability to drive safely is impaired, the officer shall not allow the individual to continue to drive. The officer’s primary concern should be for the safety of the community and the impaired



Administrative and Operational Manual

September 12, 2022

driver. Depending on the circumstances, there are several options. The officer may, with the individual's permission, take the individual to the district station or other location where he or she may recover sufficiently to drive. The officer may summon, or allow the individual to summon, someone else to drive; or the officer may call a taxi for the individual. If appropriate, with supervisory approval, police may choose to provide the individual with transportation.

**4-239.7 MARYLAND TRANSPORTATION ARTICLE REQUIREMENTS**

As required under the Maryland Transportation Article (TR § 16-901-905) cited above, the following procedures shall be complied with:

- The involved officer shall, as soon as practicable, contact, or have Communications contact, the U.S. Department of State in order to verify the driver's status and immunity, if any;
- The officer shall record all relevant information from the individual's driver's license or identification card;
- The officer shall complete any and all reports, citations or other charging documents, related to the incident, by the end of the next business day. If the incident occurs on the last day of an officer's shift, the report will be submitted by the end of the shift. If unable to complete the report by the end of the shift, the report will be submitted with as much information as possible, and a supplement will be submitted by the end of the next business day.
- All reports will be submitted to a supervisor for approval as soon as completed. A note will be attached to all related reports / citations notifying the Records Section that the incident is related to diplomatic immunity.
- The Records Section will process all reports / citations related to traffic incidents involving diplomatic immunity, as soon as possible, to ensure that copies may be forwarded, as required by law, to the Motor Vehicle Administration within five days of the incident.

**4-239.8 PARKING VIOLATIONS - VEHICLES BEARING DIPLOMATIC TAGS**

Parking violations will be handled in the same manner as other vehicles except that no vehicle owned by an individual with diplomatic immunity will be impounded.

**4-239.9 NOTIFICATION IN CASE OF SERIOUS INJURY OR DEATH TO DIPLOMAT**

When a diplomat is seriously injured or dies in the County, the appropriate division commander or district / shift commander will make direct notification to the diplomat's Embassy, the U.S. Department of State and as required in the AOM Section 4-710.

**4-239.10 DEPARTMENT OF STATE CONTACTS**

If a question arises regarding diplomatic immunity or notification concerning an incident needs to be made, Communications has current telephone numbers for the U.S. Department of State.

[REDACTED]

[REDACTED]

[REDACTED]





Administrative and Operational Manual

September 12, 2022

Office. Rewards, by-laws, and treasury are coordinated through the assistance of public, civil, and fraternal organizations. The media's role consists of donating public service time on radio and in newspapers to air information about crimes in the County.

4-241.1 PROCEDURES - REWARD OFFERED

The Crime Solvers Program offers up to a \$1,000 reward for information leading to an arrest or indictment with information received through the Crime Solvers Tip Line. A tipster has three ways of communicating to Crime Solvers with a tip: call in, text, or web-based tip. The tip is received and assigned a number. The Crime Solvers program does not need the caller's name or anything about him, just the information about the crime. The Agency Coordinator reviews the tip and disseminates it to the proper unit for investigation. If the caller's information turns out to be valuable, the information is then presented to Crime Solvers at their monthly meeting. The members of Crime Solvers hear the tip and the type of case it involves (arrest warrant, drug related, or general criminal activity) and determines the amount of reward to be paid. The tipster is recognized by their assigned number only. It is the tipster's responsibility to follow up with the Coordinator regarding the reward payout.

4-241.2 PERSONAL USE PROHIBITED

Personal use of the Crime Solvers Tip Line shall be prohibited.

[Redacted content consisting of multiple blacked-out lines and paragraphs]





Administrative and Operational Manual

September 12, 2022

[REDACTED]

[REDACTED]

[REDACTED]

[REDACTED]

[REDACTED]

- [REDACTED]
- [REDACTED]
- [REDACTED]

[REDACTED]

[REDACTED]

- [REDACTED]
- [REDACTED]
- [REDACTED]
- [REDACTED]

[REDACTED]

[REDACTED]

[REDACTED]

[REDACTED]



Administrative and Operational Manual

September 12, 2022

[REDACTED]

- [REDACTED]
- [REDACTED]
- [REDACTED]
- [REDACTED]
- [REDACTED]
- [REDACTED]
- [REDACTED]
- [REDACTED]
- [REDACTED]

[REDACTED]

[REDACTED]

[REDACTED]

[REDACTED]

- [REDACTED]
- [REDACTED]
- [REDACTED]

[REDACTED]

[REDACTED]



## Administrative and Operational Manual

September 12, 2022

## 4-244 RACIAL, RELIGIOUS, ETHNIC, SEXUAL ORIENTATION, AND DISABILITY BIAS (HATE CRIMES)

The Annotated Code of Maryland (Public Safety Article) requires that data concerning incidents apparently directed against an individual or group, because of race, religion, ethnicity, sexual orientation, or disability be collected and analyzed. The law places that responsibility with the Maryland State police and requires that local law enforcement and the State Fire Marshal provide this information to the State Police.

Within the CCSO, the responsibility of providing this information to the Maryland State Police will be that of the Records Section. All employees of this Agency will cause a report of such incidents to be made, when they become aware of information concerning them, in order that the Records Section may carry out this Responsibility.

### 4-244.1 DEFINITIONS

**Hate Crimes** - A hate crime is a criminal act motivated or perceived by the victim to be completely or partly motivated by race, religion, ethnic background, sexual orientation or disability.

**Hate - Based Incident** - An act, which appears to be or perceived by the victim to be completely or partly motivated by bias or hatred toward a race, religious belief, national origin, ethnic background, sexual orientation or disability. An example of a hate-bias incident could be using demeaning language or making threats against another person or group.

Some incidents may not clearly fit a specific definition. A common sense approach must be used. If it appears to be a hate-bias incident, it should be reported as such. The key criteria for determining whether a crime or incident is of a hate-bias nature is the motivation behind the act.

### 4-244.2 DETERMINATION OF INCIDENT

An incident will be classified as falling under the reporting requirements of Maryland law if:

- racial, religious, ethnic, or reference to disability statements are made during the incident;
- hate group symbols are displayed;
- the motive of a crime is to harm, injure or intimidate a particular group or organization;
- the complainant believes the incident is racially, religiously, ethnically or sexual orientation motivated; and
- the investigating officer, supervisor, or investigator can reasonably determine that the incident is racial, religious, ethnic or sexual orientation motivated.

A report will be made in all of these cases even if there is no specific violation of law. There is no requirement of a criminal act necessary, in order that a report must be made under Maryland law.

### 4-244.3 RELATED CRIMINAL ACTS

**Maryland Code, Criminal Law Article § 10-301. Damaging property of religious entity:**

A person may not deface, damage, or destroy, or attempt to deface, damage, or destroy, personal or real property that is owned, leased or used by a religious entity or for any religious purpose including:

- (1) a church, synagogue, or other place of worship;
- (2) a cemetery;
- (3) a religious school, educational facility, or community center; and



Administrative and Operational Manual

September 12, 2022

(4) the grounds adjacent to them.

**Maryland Code, Criminal Law Article § 10-302. Obstructing exercise of religious belief:**

A person may not, by force or threat of force, obstruct or attempt to obstruct another in the free exercise of that person's religious beliefs.

**Maryland Code, Criminal Law Article § 10-303. Harassment: destruction of property:**

Because of another's race color, religious beliefs, or national origin, a person may not:

- (1) harass or commit a crime against that person;
- (2) damage the real or personal property of that person;
- (3) deface, damage, or destroy, attempt to deface, damage, or destroy the real or personal property of that person;  
or
- (4) burn or attempt to burn an object on the real or personal property of that person.

**Maryland Code, Criminal Law Article § 10-305. Damage to associated building:**

A person may not deface, damage, or destroy, attempt to deface, damage, or destroy, burn or attempt to burn an object on, or damage the real or personal property connected to a building that is publicly or privately owned, leased, or used, including a cemetery, library, meeting hall, recreation center, or school:

- (1) because a person or group of a particular race, color, religious belief, or national origin has contacts or is associated with the building; or
- (2) if there is evidence that exhibits animosity against a person or group, because of the race, color, religious beliefs, or national origin of that person or group.

**Maryland Code, Criminal Law Article § 10-305. Penalty:**

A person who violates this subtitle is subject to the following penalties:

- (1) if the violation involves a separate crime that is a felony, the person is guilty of a felony and on conviction is subject:
  - (i) to imprisonment not exceeding 10 years or a fine not exceeding \$10,000 or both; or
  - (ii) if the violation also results in death to a victim, to imprisonment, not exceeding 20 years or a fine not exceeding \$20,000 or both; and
- (2) in all cases, the person is guilty of a misdemeanor and on conviction is a subject to imprisonment not exceeding 3 years or a fine not exceeding \$5,000 or both.

**Maryland Code, Criminal Law Article § 10-306. Additional prosecution not precluded:**

Prosecution of a person under this subtitle does not preclude prosecution and imposition of penalties for another crime addition to the penalties imposed under this subtitle.



**Administrative and Operational Manual**

**September 12, 2022**

Maryland Code, Criminal Law Article § 3-803 deals with harassment.

Maryland Code, Criminal Law Article § 4-503 deals with explosives, Molotov cocktails and pipe bombs respectively.  
Maryland Code, Criminal Law Article § 6-107 deals with bomb threats.

Maryland Code, Criminal Law Article § 6-301 deals with destroying or damaging the property of another.

Maryland Code, Criminal Law Article § 10-201 deals with disorderly conduct.

Maryland Code, Criminal Law Article § 4-208 deals with the possession of a firearm at demonstrations.

Maryland Code, Criminal Law Article § 3-804 deals with telephone misuse.

Maryland Code, Criminal Law Article § 6-401 to 410 deals with trespass.

Also, the common law crimes of assault and battery may apply. Assault may be constituted by threats alone if the perpetrator possesses the apparent means to carry out the threat.

#### **4-244.4 OFFICER'S RESPONSIBILITIES**

The responding officer shall, in addition to the normal responsibilities required on any call for service, assure the following:

- that a supervisor is advised of and given all the known information regarding any verified incident covered under this section; and
- that a preliminary investigation is conducted, including a neighborhood canvass to locate witnesses and/or to develop information and investigative leads; and
- that the scene is processed for latent lifts, photographed, and any evidence collected; and
- ensure the district / shift commander is notified of the incident; and
- a full and complete report, classified as a "Hate Crime" with a sub-classification of what type of bias (racial, religious, ethnic, sexual orientation or disability), of the incident and associated information and evidence is completed and submitted prior to the end of the officer's tour of duty.

#### **4-244.5 SUPERVISOR'S RESPONSIBILITIES**

The supervisor will respond to the scene of all verified incidents of a Hate Crime which may have media attention, or of impact because of injury, damage or community tension and covered under this section, or in the event there is no scene, will meet with the victim, and:

- determine the need for the immediate involvement of a criminal investigator and request the investigator as appropriate; and
- in cases involving the setting or attempt to set a fire, the Fire Marshal will be notified; and
- reassure the victim of the Agency's commitment to investigate and resolve incidents covered by this section; and



**Administrative and Operational Manual**

**September 12, 2022**

- notify the district / shift commander of the facts and circumstances of the incident.

If the supervisor determines that his presence at the scene or to meet the victim is not necessary, the supervisor will still confirm that all mandates of this section have been complied with. The supervisor will ensure a Commanders' Information Report has been completed and submitted.

#### **4-244.6 COMMANDER, CRIMINAL INVESTIGATIONS DIVISION RESPONSIBILITIES**

The Commander, Criminal Investigations Division will monitor reports of all incidents covered by this section. In any case where there appears to be an organized effort behind an incident or group of incidents, the appropriate resources will be afforded. The Commander will cause a follow-up investigation to be conducted in all cases:

- which show repeat incidents in a particular area or against a particular group or individual; or
- which have made a large media impact or have raised considerable tension or apprehension within the community; or
- which involve serious injury or great property damage; or
- which involve the commission of a felony.

#### **4-244.7 DISTRICT / SHIFT COMMANDER'S RESPONSIBILITIES**

The district / shift commander shall monitor the activities of Agency personnel who have responded to incidents covered by this section. Reports of such incidents will be forwarded to the Sheriff, the Assistant Sheriff of Operations, and the Commander, CID. In cases of considerable media attention, or of considerable impact because of injury, damage or community tension, the Assistant Sheriff of Operations and the Sheriff will be contacted and informed of the circumstances of the incident. Commanders will make a determination if a Patrol Check is needed for the incident.

### **4-245 CIVIL OR CRIMINAL PROCESS ON INMATES**

#### **4-245.1 PURPOSE**

The purpose of this policy is to set forth guidelines regarding service of criminal process or other legal documents on inmates incarcerated in the Charles County Detention Center.

Adherence to this policy is essential for the efficient operation of the Charles County Sheriff's Office, as well as for the protection of the Agency from possible lawsuits.

#### **4-245.2 GENERAL**

Whenever civil or criminal process, such as warrants, criminal summons, indictments, summons, or any other legal document, is served on an inmate incarcerated at the Charles County Detention Center (CCDC) by a member of this Agency, a copy of said document(s) shall be left by the serving member with Intake Records at CCDC. The officer shall also indicate on the copy to be turned into the Records Management Section or Civil Unit of the Charles County Sheriff's Office the name of the Intake Records officer to whom the copy was given.



**Administrative and Operational Manual**

**September 12, 2022**

---

Subject to the regulations of the Charles County Detention Center, and in accordance with any applicable policies found elsewhere in this Manual, sworn officers and Agency Civil Process Server Specialists may have contact with inmates at any time for purposes of conducting official business. This includes warrant and civil process service, as well as conducting interviews and investigations. Officers and Agency Civil Process Server Specialists must present proper law enforcement identification prior to contact with inmates.

Private civil process servers are not permitted contact with inmates for process service. Employees approached by private civil process servers wishing to either make personal service on an inmate, or requesting the employee accept the process for service on the inmate, will refer the process server to the Civil Unit of the Judicial Services Section.

**4-246 RETURNS OF CIVIL PROCESS**

On all returns, write "Troy D. Berry" in the block indicating served. Directly under the Sheriff's name, write "by," if not already on the paper, and the name of the officer serving the process.



Administrative and Operational Manual

September 12, 2022

## 4-248 EXTRA - JURISDICTIONAL INCIDENTS OUTSIDE CHARLES COUNTY (Criminal Procedure, Title 2)

**NOTE:** this law gives sworn officers some powers of arrest not previously available before its enactment. It does not cancel or modify any authority or powers previously available to sworn law enforcement officers who are in pursuit of fleeing felons into another jurisdiction. This law applies only within the geographical boundaries of the State of Maryland.

### 4-248.1 GENERAL

Any sworn officer who discovers an incident requiring police attention in another Maryland jurisdiction shall cause notification to be made to the police agency for the area of occurrence.

The sworn officer need not standby for the other agency. However, if immediate action is necessary to prevent personal injury or property damage, the sworn officer may take such action if permitted by law (see Section 4-248.3).

When taking action in another jurisdiction, the officer continues to be governed by the Charles County Sheriff's Office policy and procedures. A violation of a rule, regulation, or directive of this Agency subjects the officer to administrative sanctions. Such violation does not, and is not intended to, abrogate the legality of any law enforcement action taken pursuant to the authority prescribed by law and described herein.

All provisions of this section apply to on-duty and off-duty actions.

### 4-248.2 DEFINITIONS (Apply to Sections 4-248 and 4-249)

**Emergency** - A sudden or unexpected happening or an unforeseen combination of circumstances that calls for immediate action to protect the health, safety, welfare, or property of an individual from actual or threatened harm, or from an unlawful act.

**Federal Law Enforcement Officer** - An officer who is empowered to effect an arrest with or without a warrant for violations of the United States code and who is authorized to carry firearms in the performance of the officer's duties.

**Home Jurisdiction** - Political jurisdiction in which the officer is normally employed to perform police service, e.g., Charles County in the case of a Charles County Sheriff's Deputy.

**Host Jurisdiction** - Political jurisdiction where an incident physically occurs and where the visiting officer takes police action.

**Host Agency** - Law enforcement agency in the host jurisdiction which received official notification of the visiting officer's police actions.

### 4-248.3 EXTRA - JURISDICTIONAL AUTHORITY OF OFFICERS

Charles County Sheriff's Office sworn employees may exercise police powers in other Maryland jurisdictions if:





Administrative and Operational Manual

September 12, 2022

- An emergency, as defined in Section 4-248.2, exists; or
- Requested by the host jurisdiction's police officer or by a sworn employee of the Maryland Department of State Police; or
- Assisting an officer, even if such assistance was not specifically requested; or
- Operating in a joint investigation or task force involving other federal, state, or local law enforcement agencies, provided that at least one of those agencies has local jurisdiction.

When taking action in one of these situations, officers are empowered with full police authority, except that they shall not enforce any motor vehicle law under the provisions of this section. The officers may make criminal arrests, seize evidence, conduct investigations, and take other appropriate actions to enforce state laws.

While performing these duties in the host jurisdiction, the officer enjoys the same immunities from liability that apply to him in his home jurisdiction, as well as any immunities that apply to Maryland State Police officers. The officer remains for all purposes a Charles County Sheriff's Office employee.

#### 4-248.4 NOTIFICATIONS

Officers who take action in another jurisdiction shall cause notification to the host jurisdiction's police department (or Sheriff's Office when no police department exists) as soon as practical. If the officer is tactically involved and does not have access to a police radio, he may ask a citizen to telephone the local police.

If the incident occurred in a municipality, notification shall be made to the municipal police rather than the County agency. If the incident occurred on state owned or controlled property, notification shall be to the Maryland Department of State Police (or where applicable, the Department of Natural Resources Police, the Maryland Transportation Authority Police, the Maryland Port Administration Police or the Mass Transit Administration Police).

When the action is taken pursuant to a task force or joint investigation, the officer shall cause notification in advance of the action, if practical. Notification to the host jurisdiction's participating officer may be sufficient, although other procedures may be required for certain agencies.

When making notification, the officer may request that the host agency respond to the scene of any incident; such a request is mandatory if:

- an arrest was made; or
- the officer displayed a weapon or used force; or
- any person was injured or medical attention was requested; or
- a felony occurred; or
- a victim desires to file an incident report; or
- evidence is available for processing, or unattended property needs to be recovered or guarded; or
- there is reason to believe that further disturbances will occur following the officer's departure.

The officer shall notify, or cause to be notified, the Charles County Sheriff's district commander / shift commander, immediately if possible, or if not, within one hour following completion of an extra - jurisdictional action, except when that action was taken as part of his standard duties in a task force or joint investigation.

#### 4-248.5 TRANSPORTING PRISONERS

If the officer makes an arrest and does not have a Sheriff's Office vehicle appropriate for prisoner transport, he shall



Administrative and Operational Manual

September 12, 2022

request that the host agency make the transport. If the host agency refuses, the officer shall contact the Charles County Sheriff's district / shift commander for guidance.

Unless authorized by the district / shift commander, or other Charles County Sheriff's official, prisoner transports in privately-owned vehicles are prohibited except in emergencies or when timely contact with appropriate authorities is physically impossible, e.g., arrest occurring in an isolated rural area without phone or radio.

Prisoners shall be transported to a police or court facility in the host jurisdiction and shall not be brought back to Charles County, except when transport to a different location is specifically authorized within a task force or joint investigation.

#### 4-248.6 TRANSFER OF INVESTIGATIVE RESPONSIBILITY

The law does not require responsibility for a case, or custody of a prisoner, to transfer to the host agency. However, Charles County officers taking action in other jurisdictions shall offer such a transfer unless the officer discharged a weapon, injured a person during his action, or took that action in the course of a joint investigation or task force operation.

If the officer's firearm discharged or an injury occurred, the officer shall cause notification to the Charles County district / shift commander for determination regarding any transfer. The officer may consult with the district / shift commander in any other situation where he believes transfer may be inappropriate.

If the action occurred as a result of a task force or similar joint investigation, procedures previously agreed upon, by the participating agencies, will establish who has investigative responsibility, or identify the individual who will make that decision.

The host agency may accept or decline a transfer of investigative responsibility. If the host agency accepts, the officer shall yield authority to the assigned host investigator, cooperate with that investigator, and make himself available as a police witness for court.

If the case is not accepted by the host agency, the officer shall have complete investigative responsibility as if the crime occurred in Charles County. If he has made an arrest, he shall charge his prisoner on a Statement of Charges and present him to a Commissioner in the host jurisdiction. He shall also recover and process evidence, obtain statements, coordinate with the local State's Attorney's Office, and perform all other appropriate follow-up investigation.

The officers' district commander may request an investigator to assist the officer with follow-up duties, if appropriate.

#### 4-248.7 PROCESSING AND REPORTS

Whenever an officer takes action (which requires the use of police powers, e.g., makes an arrest or uses force) in another jurisdiction, he shall complete an Offense / Incident Report Form #20 upon his return to Charles County. The report shall:

- describe the officer's actions and identify the reasons why action was taken; and
- list the names, addresses, and phone numbers of all known victims, witnesses, and suspects (if the host agency processes a Charles County officer's apprehended prisoner, list the host agency's processing I.D. number for that prisoner); and



Administrative and Operational Manual

September 12, 2022

- 
- record the date, time, and method of notification to the host agency, and identify, by name, the host agency official who received that notification; and
  - describe the host agency response or supporting actions, and indicate whether a transfer of custody or investigative responsibility occurred; and
  - list the out-of-County address of occurrence in the location block.

If the officer makes an arrest and the host agency, because of the nature of the case, assumes custody of the prisoner, the host agency may prepare the charging document, complete an Arrest Report, process the prisoner, and present him to the Commissioner. This may occur in serious felony cases requiring extensive case preparation. In these cases, no documents other than the above-described Incident Report are required of the officer.

If the host agency does not accept custody and the prisoner is charged by the Charles County officer, the officer shall obtain a Charles County arrest / ID number for use with the charging document, and shall complete a Charles County Arrest Report upon his return to the County. He shall also fingerprint and, if possible, obtain a photograph of the prisoner using host agency facilities and print cards. If the host agency refuses to provide cards or allow use of its equipment, he shall not process the prisoner and shall note the host agency's refusal in the Incident Report narrative.

#### 4-248.8 DISTRICT COMMANDER RESPONSIBILITIES

Upon notification that an officer is involved in an extra - jurisdictional action, the district / shift commander shall immediately notify the appropriate host agency by telephone unless the officer has already done so. If a local host agency cannot be identified or contacted, the Maryland State Police shall be notified. The district / shift commander shall make all Sheriff's Office Command Staff notifications as would be required for an incident happening within Charles County.

The district / shift commander shall ensure that the name and assignment of the host agency official accepting notification is provided to the officer involved in the extra - jurisdictional action.

#### 4-248.9 SCHEDULED PRISONER TRANSPORTS

**Scheduled transports** are routine deliveries of a prisoner from one police, corrections, or court facility to another for presentment before a Commissioner or other Judicial Officer, investigative purposes, medical purposes, etc. Such transports do not include removal of prisoners from the scene of an arrest.

Officers shall maintain custody and control of prisoners during scheduled transports in other jurisdictions, using the same degree of force necessary to control the prisoner or prevent escape as would be permitted in Charles County.



Administrative and Operational Manual

September 12, 2022

---

## 4-249 EXTRA - JURISDICTIONAL INCIDENTS INSIDE CHARLES COUNTY (Criminal Procedure, Title 2)

### 4-249.1 GENERAL

Sheriff's Office personnel shall assist officers from other jurisdictions who take lawful emergency police action in Charles County. Assistance includes, but is not limited to, transporting prisoners, investigative support, processing evidence, and providing fingerprint cards and equipment.

Because outside officers from other Maryland jurisdictions and Federal Officers (see Section 4-248.2 for definition of Federal Officer) have full police authority when acting under provisions of the extra - jurisdictional authority statute, Charles County officers are not required to confirm probable cause or examine all facts of a case before rendering general assistance. They shall initially rely upon a good faith expectation that the other officer is acting properly unless circumstances suggest otherwise.

Prior to any Charles County officer transporting a prisoner, or accepting transfer of investigative responsibility for a case, the facts of the case shall be examined and the probable cause for any arrest confirmed. If the officer believes that the outside officer's conduct is improper or that an arrest is illegal, he shall request the assistance of a supervisor.

If the supervisor also doubts the probable cause or finds the outside officer's actions improper, he shall ensure that no transfer of prisoner custody or case responsibility occurs, and that the prisoner is not transported by a Charles County officer. Obtaining an alternative means of transport shall be the outside officer's responsibility.

If probable cause is judged insufficient or his actions improper, the outside officer may still be allowed to utilize Sheriff's Office facilities, including holding cells and processing equipment, in order to expedite the prisoner's presentment to a Commissioner. Sheriff's Office personnel shall not accept custody of the prisoner, and shall limit control over the outside officer and his prisoner to the extent necessary to ensure the safety and security of the processing facility.

Nothing in this policy is intended to prevent a CCSO officer from taking appropriate action in a case where another officer's conduct is illegal. Likewise, when a prisoner is in jeopardy because of the illegal actions of the arresting officer, CCSO officers may take actions necessary to protect any person. These cases should be handled in the same manner as an Internal Affairs case, and the appropriate investigative and supervisory notification made.

### 4-249.2 NOTIFICATIONS AND REPORTS

Any employee receiving notification of an extra - jurisdictional action in Charles County by another jurisdiction's officer shall notify the available district commander, shift commander or sector supervisor.

If no Charles County sworn officer is currently on the scene, or otherwise handling the event, the appropriate commander / supervisor shall cause the dispatch of a Charles County patrol officer if:

- the outside officer is still at the scene; or
- any imminent conflict or hazard has not been completely resolved by the outside officer's action; or
- an Incident Report remains to be taken from someone still at the scene.

If none of these conditions exist, the commander / supervisor shall request the call be assigned to an appropriate investigator. The investigator may be either a patrol officer or other sworn investigator as deemed appropriate by the commander / supervisor. The investigator shall conduct an investigation and cause the necessary report(s) to



Administrative and Operational Manual

September 12, 2022

be written. The extent of the investigation shall be determined by the seriousness of the incident, and may involve no more than an inquiry to the outside officer's agency, when appropriate.

The patrol officer or investigator shall complete an Incident Report. If no criminal offense is confirmed, he shall title the report Extra - jurisdictional Incident. If a criminal offense is confirmed, he shall title the report with the appropriate criminal violation; e.g., robbery, and write Extra - jurisdictional Incident in bold letters at the beginning of the narrative section.

The report shall:

- list the outside officer's name, I.D. number, agency, and agency phone number; and
- list names, addresses, and phone numbers of all victims, witnesses and suspects; and
- describe the actions of the outside officer and the assisting Charles County officers, indicating whether any transfers of prisoner custody or investigative responsibility occurred or were offered.

Officers who assist outside officers, and employees who receive notifications of extra - jurisdictional actions, shall request the outside officer or agency to forward copies of the other agency's reports and records of the incident to the Charles County Sheriff's Office Records Section.

**NOTE:** Statistical information for UCR shall not be gathered from these incidents. This responsibility rests with the jurisdiction in which the crime occurred.

### 4-249.3 TRANSFER OF INVESTIGATIVE RESPONSIBILITY

The Sheriff's Office may accept custody of prisoners and assume investigative responsibility for a case if the other jurisdiction's officer is willing. In such instances, the outside officer shall be asked to provide a written statement regarding his actions and be summoned as a police witness. If custody of the prisoner is transferred, a Charles County officer shall prepare the charges, complete the Arrest Report, process the prisoner, and present him to a commissioner.

If the extra - jurisdictional incident involves a felony, the appropriate investigative component of the Charles County Sheriff's Office shall be notified and shall make an effort to assume investigative responsibility, including accepting custody of all legally arrested suspects. If the outside officer refuses to relinquish the case, the officer's agency shall be contacted with a request for cooperative transfer of the investigation. A supervisor or commander will make this request. If the outside agency refuses, appropriate support will continue to be provided and the refusal shall be noted in the Incident Report.

The Sheriff's Office may decline to accept custody of any prisoner and responsibility for any case, including felonies, if circumstances warrant. These instances will be approved by the district / shift commander.

### 4-250 FOOT PURSUIT POLICY

#### 4-250.1 DEFINITIONS

**Foot Pursuit** — When an officer pursues, on foot or bicycle, a person who is attempting to evade law enforcement.

**Reasonable Articulable Suspicion (RAS)** — A well founded suspicion based on specific, objective, articulable facts, taken together with the officer's training and experience, that a subject has committed, is committing, or is about to commit a crime.



Administrative and Operational Manual

September 12, 2022

**Probable Cause (PC)** – Facts and circumstances within an officer’s knowledge, that are sufficient in themselves, to warrant a reasonable officer to believe that a subject has committed, is committing or is about to commit a crime. Probable Cause (PC) is a higher standard of proof than RAS.

### 4-250.2 JUSTIFIED PURSUITS

It is the policy of the Charles County Sheriff’s Office (CCSO) that officers may engage in foot pursuits with suspects only when there is at least:

- Reasonable Articulate Suspicion (RAS) to believe that the suspect has committed, is committing, or is about to commit a crime; and/or
- The suspect is believed to have an active warrant for their arrest; or
- The subject is believed to have a Court Ordered Emergency Petition; or
- The officer, based on observation or other information, has reason to believe that the subject has a mental disorder and presents a danger to the life or safety of the subject or others.

The mere act of flight alone by a person shall not serve as justification for engaging in a foot pursuit. Officers are prohibited from basing an investigative stop only on a person’s response to the presence of police, such as a person’s attempt to avoid contact with an officer or flight.

### 4-250.3 OFFICER, COMMUNITY AND SUSPECT SAFETY

When deciding to initiate or continue a foot pursuit, officers must continuously balance the objective of apprehending the suspect(s) with the risk and potential for injury to officers, bystanders, or the suspects. Officers must act reasonably, based on all of the circumstances.

### 4-251 DECISION TO PURSUE

Deciding to initiate or continue a foot pursuit is a decision that an officer must make quickly and under unpredictable and dynamic circumstances. It is recognized that foot pursuits may place CCSO officers and the public at risk. Officers should consider the following factors when initiating a foot pursuit:

- The severity of the crime; and/or
- Whether the subject is an immediate threat to the officers or others.

Any doubt by participating officers or their supervisors regarding the overall safety of any foot pursuit should be decided in favor of communication, coordination, surveillance, and containment.

Surveillance and containment are generally the safest tactics for apprehending fleeing persons.

In deciding whether to initiate or continue a foot pursuit, officers and supervisors should continuously consider reasonable alternatives based upon the circumstances and resources available, such as:

- Containment of the area;
- Saturation of the area with law enforcement personnel, including assistance from other agencies;
- A canine search;
- Thermal imaging or Unmanned Aerial System (UAS) technology;
- Air support; and/or;
- Apprehension at another time when the identity of the suspect is known or there is information



Administrative and Operational Manual

September 12, 2022

available that would likely allow for later apprehension, and the need to immediately apprehend the suspect does not reasonably appear to outweigh the risk of continuing the foot pursuit.

Once a subject is contained and the active foot pursuit has terminated, officers and supervisors will proceed with a search for the individual using the resources available and the appropriate tactics and techniques to locate, and take the subject into custody.

If during the search, the subject is located and a subsequent foot pursuit occurs, the guidelines of this policy will apply.

#### 4-251.1 PROHIBITED ACTIONS

Officers shall not engage in a foot pursuit when their initial RAS or PC is for a violation that would constitute a:

- Civil violation;
- Citation-only violation, excluding those offenses in which a warrantless arrest is authorized; or
- Any non-arrestable violation.

#### 4-251.2 PURSUIT GUIDELINES

Officers should consider these factors when deciding to engage in, or continue, a foot pursuit:

- Whether the officer is acting alone;
- Whether the officer is unsure of their location and direction of travel;
- Whether the officer is uncertain of their ability to control the suspect if apprehension is made;
- Whether the officer loses radio contact with Communications or with assisting or backup officers;
- Whether the officer becomes aware of unanticipated circumstances that unreasonably increase the risk to employees or the public;
- Whether the officer reasonably believes that the danger to the pursuing officers outweighs the objective of immediate apprehension;
- Whether the officer or a third party is injured during the foot pursuit, requiring immediate assistance, and there are no other emergency personnel available to render assistance;
- Whether the suspect's location is no longer known;
- Whether the identity of the suspect is established or other information exists that will allow for the suspect's apprehension at a later time, and it reasonably appears that there is no immediate threat to CCSO officers or the public if the suspect is not immediately apprehended;
- Whether the officer's ability to safely continue the foot pursuit is impaired by inclement weather, darkness, or other environmental conditions, such as steep terrain, worn-out structures, piles of debris, etc.;
- Whether the presence of vehicular traffic in the area of the pursuit and risk of emergency vehicle response



**Administrative and Operational Manual**

**September 12, 2022**

by additional officers create safety concerns;

- If acting alone and the pursuit results in an officer chasing two or more suspects simultaneously;
- If two or more officers have multiple suspects detained and one suspect flees, an officer should consider not pursuing the fleeing suspect if that leaves their fellow officer(s) in an unsafe tactical situation; and/or
- An officer shall not initiate or continue a foot pursuit if the officer knowingly loses possession of their firearm, radio, or other essential equipment which may endanger the officer or public if recovered by another person.

## **4-252 RESPONSIBILITIES IN FOOT PURSUITS**

### **4-252.1 INITIATING OFFICER RESPONSIBILITIES**

Unless relieved by another officer or a supervisor, the initiating officer shall be responsible for coordinating the progress of the pursuit and containment.

Early communication of available information is essential. Officers engaging in a foot pursuit must initiate a radio broadcast within the first few seconds to ensure that adequate resources are coordinated and deployed to assist and manage the pursuit to a safe conclusion. The broadcast should contain the following information, at minimum:

- Location and direction of travel;
- Unit identifier/call number;
- Reason for the foot pursuit, such as the crime incident type;
- Number of suspects and physical descriptions, to include name if known; and
- Whether the suspect is known or believed to be armed with a dangerous weapon.

Officers should be mindful that radio transmissions made while running may be difficult to understand and may need to be repeated.

Absent exigent circumstances, any officer unable to promptly and effectively broadcast this information should terminate the foot pursuit. If the foot pursuit is discontinued for any reason, immediate efforts for containment should be established and alternatives considered based upon the circumstances and available resources.

When acting alone, the initiating officer should consider the dangers of making an apprehension alone and may consider keeping the suspect in sight until sufficient officers are present to assist with safely apprehending the suspect.

In the event that the suspect enters a building, structure, confined space, wooded or otherwise isolated area, the initiating officer shall assess the situation, notify police dispatch of their location and determine whether to wait for the arrival of responding officers and a supervisor so a perimeter around the area can be established.

### **4-252.2 RESPONSIBILITIES FOR FOOT PURSUITS INVOLVING TWO OR MORE OFFICERS**

Officers should try not to separate, should remain in sight of each other, and maintain communications. Officers separating can compromise their safety and impair their ability to assist or effectively communicate with each other.





**Administrative and Operational Manual**

**September 12, 2022**

Officers separating should be used only when necessary to protect others from imminent harm or to gain a tactical advantage.

When two or more officers become separated, lose visual contact with one another, or obstacles separate them to the degree that they cannot immediately assist each other should a confrontation take place, it is generally recommended that a single officer keep the suspect in sight from a safe distance and coordinate the containment effort.

### **4-252.3 BACKUP OFFICERS' RESPONSIBILITIES**

Whenever any officer announces that they are engaged in a foot pursuit, all other officers should minimize non-essential radio traffic to provide the involved officers with maximum access to radio communications.

Respond in a safe manner, and take an active role in the apprehension of the suspect by assisting the initiating officer.

### **4-252.4 TERMINATING A FOOT PURSUIT**

When a foot pursuit terminates, the officer will notify the dispatcher of their location and the status of the foot pursuit termination (e.g., suspect in custody, lost sight of suspect, etc.) and will direct further actions as reasonably appear necessary, to include requesting needed medical aid for officers, suspects, or other persons.

### **4-252.5 SUPERVISOR RESPONSIBILITIES**

Upon becoming aware of a foot pursuit, the supervisor shall make every reasonable effort to ascertain sufficient information to direct responding resources and to take command, control, and coordination of the foot pursuit.

The supervisor will respond to the area whenever possible. The supervisor does not need to be physically present to exercise control over the foot pursuit. The supervisor shall continuously assess the situation in order to ensure the foot pursuit is conducted within established Agency guidelines.

The supervisor shall terminate the foot pursuit when:

- It reasonably appears either that the pursuit lacks a lawful purpose or is unsupported by RAS (e.g., cases of mistaken identity where actual suspect has been apprehended elsewhere);
- The danger to pursuing officers or the public appears to unreasonably outweigh the objective of immediate apprehension of the suspect.; and/or
- The pursuit is otherwise not in compliance with this policy.

Upon apprehension of the suspect, the supervisor will promptly proceed to the termination location to direct the post foot pursuit activity when possible.

Upon arriving at the scene, the supervisor will check for any injuries to victims, bystanders, officers or suspects and ensure proper care is provided. All injuries shall be documented.

The supervisor shall review:



**Administrative and Operational Manual**

**September 12, 2022**

- 
- In-car camera footage of the event from the initiating officer and other responding officers;
  - Any written reports that were generated from the event;
  - Any other information available regarding the incident;
  - Whether the foot pursuit was in compliance with this policy;
  - Whether opportunities for de-escalation, prior to flight, or prevention of flight were missed and what tactics may have been useful;
  - If any tactics used could have been improved; and
  - The findings and provide feedback to the officers involved.

Following the supervisory review of the foot pursuit, the supervisor shall take corrective action if needed and report any necessary policy improvements, training issues or observed tactical considerations through the chain of command via memorandum.

#### **4-253 COMMUNICATIONS SECTION RESPONSIBILITIES**

Upon notification or becoming aware that a foot pursuit is in progress, Communications is responsible for:

- Clearing the radio channel of non-emergency traffic;
- Coordinating pursuit communications of the involved officers;
- Broadcasting pursuit updates as well as other pertinent information as necessary;
- Ensuring that a supervisor is aware of the foot pursuit and ensuring the Shift Commander is notified, if needed; and
- Notifying and coordinating with neighboring agencies when necessary and practicable.

#### **4-254 REPORTING REQUIREMENTS**

Within the body of the narrative of an offense/incident report and/or charging documents when necessary, officers shall include details surrounding the foot pursuit, such as, but not limited to:

- RAS and/or probable cause for any offenses;
- Reason and circumstances surrounding the foot pursuit;
- Course and approximate distance of the foot pursuit;
- Involved vehicles and officers;



Administrative and Operational Manual

September 12, 2022

- 
- Any use of force;
  - Any injuries and/or medical treatment; and/or
  - Any property or equipment damage.

In the following cases, when an incident report is not required, a Field Interview Report (FIR) shall be completed:

- A known subject eludes officers during a foot pursuit; or
- The foot pursuit of a known subject is terminated prior to apprehension; or
- If a subject is detained pursuant to a foot pursuit and it becomes apparent that there is no probable cause to continue to hold the subject. (Example: no further probable cause to effect an arrest for a criminal violation was developed or an individual was detained pursuant to a presumed warrant, but after further investigation, the warrant could not be validated). Therefore, the subject may be released; and
- There is no reportable use of force, injuries or property or equipment damage.

In those instances when a foot pursuit is terminated or a subject is not located, and the identity of the subject is unknown, all pertinent information will be entered into the call sheet and no further reporting beyond the call sheet is required.



Administrative and Operational Manual

September 12, 2022

## 4-300 TRAFFIC ENFORCEMENT

The Charles County Sheriff's Office will enforce all traffic laws and ordinances in an equitable manner. The primary objective of such enforcement is the promotion of traffic safety and the resultant reduction in traffic accidents.

Normal traffic law enforcement involves visible traffic patrol by officers in their assigned area of responsibility who observe violations during the performance of their normal duties.

Directed / selective enforcement activities involving stationary observation, unmarked vehicles, commercial vehicle violations and roadside safety checks will normally be accomplished by the Traffic Operations Unit.

Officers are expected to exercise discretion, based upon their training and experience, in carrying out traffic enforcement duties. In enforcing vehicle laws officers have the discretion to issue written warnings, citations or to make arrests. Officers are prohibited from issuing only a verbal warning on traffic stops. Enforcement actions should be based on the circumstances of the violation.

Unless otherwise directed, officers may observe a thirty-day grace period and use discretion in issuing written warning notices for newly enacted vehicle laws.

Officers are not limited as to the number of citations, Safety Equipment Repair Orders (SERO) and/or warnings that may be issued to a single violator. Officers should use sound judgment in deciding how many charges to place and should avoid citing numerous separate charges that the courts might tend to merge.

### 4-300.1 TRAFFIC AND PARKING CITATIONS BOOKS

Citation books are accounted for by serial numbers assigned to the citations contained within the citation books. Employees shall control or possess only those citation books which have been properly issued to the employee. A log book maintained in Records Management Section and any other location from which citation books are issued will be used to record the issuance of a particular series of citations to an individual employee.

The responsibility for controlling the flow of citations within the Charles County Sheriff's Office is that of the Deputy Director, Records Management Section. The Deputy Director will receive citation books from MVA (through the Quartermaster who serves as a shipping / receiving point) or, in the case of local parking citation books, from the vendor chosen to print them and will track each ticket while it is in the possession of Charles County Sheriff's Office employees. The Deputy Director will have a sufficient supply available to meet the Agency's needs.

Command personnel or their designees may temporarily receive boxes (ten books each) of citations for reissue to employees within their command. The number of boxes issued at one time will be dependent upon the volume usage as determined by the Deputy Director, Records Management. Commanders will be responsible for strict control of these citations until they are issued to an individual employee. The commander or designee will record in the command log book the information concerning the employee to whom a particular citation book is issued from stock. The tally sheets from each book, along with a note stating to whom the book was issued, will be forwarded to Records Management when the book is issued.

The Agency has been approved by the District Court to write and submit electronic citations. This enables the officer to complete the traffic citations in the MDT. The system will print one copy of the citation for the violator and upload the citation information to the court system. This eliminates the need to have a court copy of the citation.

Officers who have been trained and enabled to issue electronic citations shall issue citations with the electronic system; however, they shall also carry citation books in the event the electronic citation system goes down. The officer will comply with the training and requirements of the system being used to issue the electronic citations.



Administrative and Operational Manual

September 12, 2022

### 4-300.1.1 ISSUED CITATIONS

Officers not utilizing an electronic citation will submit remaining copies of issued citations, except the officer's copy and the violator's copy, at the end of the tour of duty in which they are written. Supervisors and clerical employees will ensure that these citations are promptly forwarded to Records Management. The Records Deputy Director will cause Charles County parking citations to be forwarded to the Accounting Section on a daily basis. All County parking citations should reach the Records Management Section by the next working day after they are written. Officers issuing citations for parking violations will use a Charles County Citation; however, if a County citation book is unavailable, a citation may be written electronically or on the Maryland Uniform Complaint and Citation Form.

Officers will ensure that witness information is entered on the reverse side of the court copy of the Maryland Uniform Complaint and Citation. When a violator is arrested and is taken before a Commissioner, a Statement of Probable Cause (Form #DC / CR-4) will be completed and presented to the Commissioner along with the citation. Processing will be in accordance with traffic arrest procedures.

Officers issuing electronic citations need to print out only the violator's copy of the citation. The violator's copy will be provided to the violator; however, the violator's signature is not required when issuing an electronic citation.

The information concerning the traffic violation will remain in the electronic citation system and an additional copy of the citation can be printed if needed at a later time. Once the electronic citation is printed, the information will be submitted directly to the District Court, and no additional copies of the citation need to be forwarded to the Records Section.

Witnesses shall be subpoenaed based on information completed by the officers in the electronic citation system.

### 4-300.1.2 VOIDING CITATIONS

The Deputy Director, Records Management Section shall have the authority to void a citation which has been improperly written upon. If an officer makes an error while writing a citation, the issuing officer will submit a Void Citation Form #113, which will be forwarded through the chain of command, along with all copies of the citation, to the Deputy Director, Records Management Section. All copies of the citation must be included, or it cannot be voided. The Form #113 must be properly endorsed by the employee's supervisor and commander. A citation which has been signed by the violator, and the violator copy has been issued, may not be disposed of in this manner; it must be disposed of in open court, either through dismissal by a District Court Judge or a declaration of Nolle Prosequi.

Voided electronic tickets should be submitted with the required signatures on Form #113 in the same manner as traditional hard copies. Records will then forward the voided packet to the State's Attorney's Office to be disposed of in open court, either through dismissal by a District Court Judge or a declaration of Nolle Prosequi. If the ticket was reissued, the officer will include the citation number of the reissued citation.

### 4-300.2 INVESTIGATIVE AND ENFORCEMENT TRAFFIC STOPS

It is the policy of the Charles County Sheriff's Office that all investigative and enforcement traffic stops will be based upon articulable and constitutionally valid suspicions. Law enforcement actions, including traffic stops, based solely or primarily on a person's race, ethnicity, age or gender are absolutely prohibited. This policy establishes guidelines for conducting constitutionally valid investigative and enforcement traffic stops.

Law enforcement officers have a duty and authority to investigate suspicious activities that may be associated with the violation of criminal and motor vehicle laws. This duty does not include pursuing hunches or stereotyping, but



## Administrative and Operational Manual

September 12, 2022

is limited to reasonable articulable factors which would likely lead any knowledgeable, reasonable officer to the same conclusion; i.e., that a violation is occurring or has occurred. The courts have held a law enforcement officer may stop a motorist for an observed violation even though the officer's real interest is determining whether the motorist is committing other crimes. This is known as a Whren or "pretext" stop. The constitutional reasonableness of a traffic stop does not depend on the actual motive of the individual officer.

Actions taken by the officer must be reasonable under the existing circumstances and based on the officer's knowledge at the time. Officers must be able to point to and describe the specific factors that raised suspicions and led him to take action in connection with the stop. Once the underlying basis for the initial stop has concluded, a police - driver encounter (subsequent seizure) which implicates the Fourth Amendment is constitutionally permissible only:

- when the driver consents to the continuing intrusion; or
- when the officer has, at a minimum, a reasonable articulable suspicion that criminal activity is afoot.

Nothing in this policy should be construed to alter the authority of a law enforcement officer to make an arrest, conduct a search or seizure, or otherwise fulfill the officer's law enforcement obligations.

#### 4-300.2.1 DEFINITIONS

The following terms are defined as they relate to this policy:

**Investigative Stop** - a stop based on reasonable articulable suspicion or knowledge of criminal activity. Information may originate with another officer or by independent investigation.

**Enforcement Stop** - a stop initiated as a result of an observed violation of the criminal or traffic code.

**Whren or "Pretext" Stop** - a stop initiated for an observed traffic violation even though the true reason for the stop is the officer's interest in investigating whether the motorist is involved in other criminal activity.

**Seizure** - in the context of traffic stops, a seizure takes place when an officer makes an investigative or enforcement stop. Seizures during all traffic stops are subject to constitutional constraints.

**Subsequent Seizure** - the continued detention of a motorist after the original reason for the stop has been satisfied.

#### 4-300.2.2 TRAINING

The overwhelming majority of the time, officers take the proper actions for the proper reasons, yet fail to provide supporting documentation to justify or explain those actions. Officers shall receive training to enhance their ability to articulate and document their actions and the reasons for them.

It is the policy of the Charles County Sheriff's Office that officers will receive periodic training to reinforce previous training and/or to develop new skills to enhance police - citizen contacts.

Training programs will include a review of the Constitution and relevant case law affecting police - citizen contacts. The importance of communication, particularly active listening and non-verbal skills, will also be stressed.

#### 4-300.2.3 COURT CASE REFERENCES

The constitutionality of searches and seizures in general and their applicability to traffic stops specifically is determined by trial and appellate courts.



Administrative and Operational Manual

September 12, 2022

The following cases are cited as references for the directives and definitions contained in this policy:  
United States v. Armstrong, 517 U.S. 456, 116 S.Ct. 1480 (1996);

Cartnail v. State, 2000 WL 764672 MD Court of Appeals, (06-14-00);

Whiting v. State, 125 Md.App. 404, 725 A.2d 623 (1999);

Charity v. State, 2000 WL 739271 MD Court of Special Appeals (06-08-00);

Terry v. Ohio, 392 U.S. 1, 88 S.Ct. 1868 (1968);

Whren v. United States, 517 U.S. 806, 116 S.Ct. 1769 (1996);

Pryor v. State, 122 Md.App. 671, 681, 715 A.2d 338, 343 (1997), cert. denied, 352 Md. 312, 721 A.2d 990 (1998);  
and

Ferris v. State, 355 Md. 356, 735 A.2d 491 (1999)

#### 4-300.2.4 TRAFFIC STOP DATA SHEET

Subsection 25-113 of the Transportation Article (TR § 25-113) of the Annotated Code of Maryland directs all law enforcement agencies in the state to gather data regarding traffic stops. The Charles County Sheriff's Office collects the required information in compliance with law. The Traffic Stop Data Sheet Form #834 was developed to meet this requirement.

An electronic version of the Traffic Stop Data Sheet was also developed and incorporated into the Mobile Data Terminal (MDT) computers' software package. Officers making traffic stops will use one of these methods to collect the required information. Officers will continue to maintain a supply of hard-bound data sheets in the event their mobile computer malfunctions.

The required information will be collected automatically by the computer systems for officers utilizing the electronic citation / warning system during their traffic stops. If an electronic warning or citation is issued, there will be no need for additional collection of data required by this policy.

The information collected by the electronic citation system will be automatically uploaded into the Agency's records management system, where it will be merged with the data collected by the paper and electronic versions of the traffic stop data sheets.

The Traffic Stop Data Sheets will be bound in books of twenty-five (25), similar in size to the Maryland Uniform Complaint and Citation book. Each sheet is individually numbered, and a receipt will be completed indicating which officer received the book. Officers will complete and submit Traffic Stop Data Sheets which have been issued to them only.

The following instructions will be adhered to when completing the Traffic Stop Data Sheet:

This form will be completed using pencil, or black or blue ballpoint pen. No other ink color or felt-tip markers of any kind will be used.

The form will be attached to the citation, SERO or warning using paper clips. Staples will not be used as they cause damage to the form.



Administrative and Operational Manual

September 12, 2022

All forms, citations, SERO's and warnings will be turned in to the officer's supervisor for review prior to the end of tour of duty each day.

The following information is required by law and will be completed on all traffic stops conducted by officers of this Agency. If a particular field on the form does not apply, it will not be completed.

**STOP INFORMATION**

**OFFICER I.D. NUMBER**

The officer conducting the traffic stop will darken the ovals corresponding with his Agency-issued identification number.

**DATE OF STOP**

Darken the ovals which correspond with the applicable month, day and year on which the stop occurs.

**TIME OF STOP**

Darken the ovals which correspond with the applicable hour and minute of the day at which the stop occurs.

**APPROXIMATE LENGTH OF STOP**

Darken the oval which corresponds with the approximate length of time the traffic stop lasted. The traffic stop begins with the actual stopping of the vehicle and lasts until the driver is informed by the officer he is free to leave the scene, or the driver is arrested. The "approximate length of stop" will include any time devoted to a search of the driver, the driver's property, the vehicle or any other related activity up to the point at which the driver is either free to leave or placed under arrest. If the officer informs a driver he is free to leave and subsequently requests and conducts a search, the "length of the stop" continues and the search information must be completed.

**NOTE:** The definition of "approximate length of stop" is based upon the information requested by the Maryland Justice Analysis Center and does not reflect or limit the definition of a stop in the context of the Fourth Amendment. thus, nothing in this section should be read as limiting an officer's investigatory tools as authorized and permitted by the Constitution and the laws of Maryland.

If an arrest of the driver is made because of a violation discovered during the course of the traffic stop, or because of a search of the person or vehicle, or because of other activity related to the stop, the officer will record the "approximate length of stop" commencing with the time the traffic stop began and ending with the time at which the driver was arrested. Prisoner processing or any subsequent investigation will not be included in the "approximate length of stop."

**LOCATION OF STOP**

Darken the ovals which correspond with the Agency-designated Sector and Beat in which the stop occurs.

**STOP TYPE**

Darken the appropriate oval if the stop resulted from radar or laser use or occurred as a result of commercial vehicle inspections.

**VEHICLE / DRIVER INFORMATION**

**STATE OF VEHICLE REGISTRATION**

Darken the appropriate oval of the state in which the vehicle is registered. If no box exists for that state, then darken the oval marked "Other" or "None" if appropriate.

**STATE OF DRIVER'S LICENSE**

Darken the appropriate oval of the state in which the driver's license was issued. If no oval exists for that





**Administrative and Operational Manual**

**September 12, 2022**

state, then darken the oval designated "Other" or "None" if appropriate.

**MD COUNTY OF DRIVER**

Darken the appropriate oval which reflects the driver's county of residence as indicated on his driver's license. If the county of residence is not shown on the Maryland driver's license, that is an indication of residence in Baltimore City, which is considered a separate jurisdiction. In this case, darken the blank oval.

**BIRTH DATE OF DRIVER**

Darken the appropriate ovals corresponding with the driver's date of birth as shown on his driver's license.

**SEX OF DRIVER**

Darken the appropriate oval.

**RACE OF DRIVER**

Darken the appropriate oval. Determination of the driver's race is to be made by the officer conducting the stop based on his personal observation of the driver at the time of the stop. Officers may use information obtained from other recognized sources (MVA records, Agency records, etc.) to verify their initial personal observations but will not ask the driver about his race or ethnicity.

**ACTION TAKEN**

**SEARCH CONDUCTED**

Darken either the "Yes" or "No" oval. This applies to the driver, the vehicle or any of the driver's property.

**DRIVER ARRESTED**

Darken the appropriate oval indicating whether or not the driver is physically arrested.

**PRIMARY "INITIAL" REASON FOR STOP**

Darken the ovals which correspond with the Transportation Article Title and Section Number or the two (2) digit code on the Safety Equipment Repair Order which is the officer's initial reason for deciding to stop the vehicle. Darken the appropriate oval(s) indicating the action taken for this violation.

**ADDITIONAL VIOLATIONS**

Darken the appropriate ovals corresponding with the Transportation Article Title and Section Number(s) or the two (2) digit code(s) on the Safety Equipment Repair Order for which the driver is being cited or warned. Darken the appropriate oval(s) indicating the action taken for these violations.

**SEARCH / ARREST INFORMATION**

**PHYSICAL ARREST CHARGES**

Darken the appropriate ovals corresponding with the motor vehicle and/or criminal charges placed against the driver only if he is physically arrested. Indicate the applicable Transportation Article Title and Section number(s) and/or the Criminal Section Code number(s).

**IF DRIVER ARRESTED**

Darken the appropriate oval indicating whether the arrest was based on the stop; i.e., DUI, Suspended License, Revoked License, etc., based on a search of the driver, his vehicle or other property, or based on other circumstances such as a wanted check, handgun in plain sight, etc.

**TYPE OF SEARCH**

Darken the oval which indicates whether the person, his property (including the vehicle) or both are searched.



Administrative and Operational Manual

September 12, 2022

DISPOSITION OF SEARCH

Darken the oval which indicates whether or not contraband or other property is seized.

REASON FOR THE SEARCH

Darken the oval which corresponds with the reason the search is conducted. If the reason is not reflected on the form, darken the oval designated as "Other" and explain the reason for the search in the space provided.

NOTES

This section is utilized to record any significant information relating to the stop.

### 4-300.3 TRAFFIC STOP PROCEDURES

Traffic stops shall be made in accordance with the procedures taught in initial and in-service training. Officers shall be mindful of the dangers inherent in approaching a vehicle, when it is not known exactly what may be within the vehicle. Officers will also consider the hazards presented by the stop environment and use the available roadway shoulder and vehicle positioning to create the safest stop possible.

Officers making a traffic stop will:

- choose a safe stop location;
- stop the cruiser behind the violator in a safe position with emergency lights activated;
- notify Communications of the stop and record the violator's license plate number for officer safety;
- approach the violator's vehicle cautiously;
- greet the violator courteously and clearly identify themselves;
- advise the citizen of the violation and request their operator's license and registration; and
- take the appropriate enforcement action by issuing a written warning, a citation or making an arrest. Offenders will not be released with only a verbal warning.

When a violator is charged with an offense for which a Maryland Uniform Complaint and Citation may be issued, the officer issuing the citation will advise the violator of the following information:

- that the Transportation Article (TR § 26-203) of the Maryland Annotated Code requires that the violator sign the citation;
- that failure to sign the citation shall necessitate the violator being taken into custody and brought before a Commissioner;
- that the act of signing the citation is not an admission of guilt, and that it is only the violator's written promise to appear in court when notified by the Court unless an optional fine is paid prior to the court date; and
- that failure to appear in court or to pay the fine pursuant to the written promise may result in the suspension of the violator's driving privileges.

#### 4-300.3.1 PLAINCLOTHES TRAFFIC STOPS

Plainclothes officers in unmarked vehicles should refrain from making traffic stops unless the violation creates a significant danger to persons or property. Officers attired in civilian clothes and operating a marked cruiser shall make traffic stops only when the violation creates a significant danger to persons or property; however, every sworn member of the Agency, unless assigned to covert operations, shall maintain a Traffic and Civil Citation book.



**Administrative and Operational Manual**

**September 12, 2022**

Maryland law provides for displaying one's license to a uniformed police officer. Plainclothes officers effecting a traffic stop shall:

- clearly identify themselves with appropriate police credentials;
- advise the citizen of the violation and request their operator's license;
- if the citizen refuses to produce a license, he will be advised such a refusal prevents the officer from writing a traffic summons in lieu of an arrest and may subject the violator to arrest;
- if the citizen continues such refusal, the officer shall call for a uniformed officer and request that the citizen await his arrival; and
- if the citizen awaits the uniformed officer's arrival, the plainclothes officer will write the summons following his receipt of the violator's credentials. If the citizen refuses to wait, he may be arrested.

Officers, while operating privately owned vehicles, shall not stop or attempt to stop a motorist for any violation.

### **4-300.3.2 JUVENILE TRAFFIC CHARGES**

Juveniles who are 16 years of age or older will be processed for non-jailable traffic violations in the same manner as adults. Whenever a juvenile is arrested for a jailable traffic offense, he will be charged on a Juvenile Offense Report. If charged with criminal and non-jailable traffic offenses, the juvenile will be charged on the Juvenile Offense Report for all infractions. Juvenile offenders being charged with multiple traffic violations, which include jailable and non-jailable offenses arising from the same incident, will be charged using the Juvenile Offense Report only.

### **4-300.3.3 ROUTINE TRAFFIC STOPS WHILE IN ANOTHER JURISDICTION**

Officers in police vehicles shall refrain from making traffic stops while traveling in another jurisdiction unless the violation creates a significant danger to persons or property.

### **4-300.4 TRAFFIC VIOLATIONS - NON-MARYLAND RESIDENTS**

Violations of the Maryland Motor Vehicle Laws by non-Maryland residents shall be processed in the same manner as those of Maryland residents. That is, residents of another state may be warned, cited or arrested as would a Maryland resident.

#### **4-300.4.1 TRAFFIC VIOLATIONS - LEGISLATORS**

While U.S. Senators and Representatives enjoy some immunities while Congress is in session, the U.S. Supreme Court has ruled on several occasions these legislators are not exempt from compliance with ordinary criminal laws. This includes violations of the Maryland Motor Vehicle Laws. Legislators, to include those at the state level, may be warned, cited or arrested for motor vehicle law violations.

#### **4-300.4.2 TRAFFIC VIOLATIONS - MILITARY PERSONNEL**

Traffic law violations committed by military personnel shall be processed as would violations by any other citizen.



Administrative and Operational Manual

September 12, 2022

## 4-300.5 TRAFFIC WARNING NOTICES

The Charles County Sheriff's Office Warning / FIR / Security Notice Form #389 may be issued to any motorists, Maryland residents or non-residents. Officer use of this notice is discretionary for any non-jailable traffic violation, parking violation or vehicle equipment defects.

Officers will advise the recipients that they are receiving a Warning Notice and will fully explain the violation for which the notice is being issued. No signature is required from the violator on the Warning Notice form.

The Agency's electronic citation system shall be used to issue warnings by those officers equipped with the electronic system. The system is designed to issue both warnings and citations during a single stop.

### 4-300.5.1 WARNING NOTICE DISTRIBUTION

Warning Notice distribution:

- Violator is given the yellow copy (2<sup>nd</sup> copy);
- Officer retains the goldenrod copy (4<sup>th</sup> copy);
- The remaining white and pink copies are sent to Records Management.
- Officers issuing an electronic warning will have only the violator's copy, and no additional copies will need to be distributed.

## 4-300.6 SPEED VIOLATIONS

Officers may take enforcement action against any violator exceeding posted / allowed speed limits. When deciding what enforcement action to take, officers should consider the location, weather, road conditions, traffic conditions and other circumstances.

### 4-300.6.1 HAZARDOUS VIOLATIONS

Hazardous violations are defined as those violations that pose a direct hazard to the safe and efficient flow of traffic and often contribute substantially to traffic accidents. Hazardous violations can include:

- excessively high speeds;
- tailgating;
- unsafe or erratic lane changes;
- unsafe passing;
- failure to obey traffic controls; and
- vehicle equipment violations.

Officers should take immediate enforcement action to correct hazardous violations.

### 4-300.6.2 DRIVING WHILE SUSPENDED OR REVOKED

An individual whose license or privilege to drive has been suspended or revoked may not drive a motor vehicle on the highways or property generally used by the public during the suspension or revocation. Generally, licenses are suspended or revoked for serious prior offenses. When deciding what enforcement action to take in these cases,



Administrative and Operational Manual

September 12, 2022

officers should check the driving record of the violator. In most cases a citation should be issued for these violations and the operator should not be allowed to continue to drive the vehicle.

### 4-300.6.3 OFF - ROAD VIOLATIONS

A person may not drive a motor vehicle in violation of any provision of the Maryland Motor Vehicle laws on any private property, property owned by or under the control of the State, County, Board of Education or Community College that is used by the public in general.

Officers will investigate complaints concerning off-road traffic violations and operators of off-road type vehicles. In those cases where a violator can be identified and/or apprehended officers will take the appropriate enforcement action.

### 4-300.6.4 PEDESTRIAN AND BICYCLE VIOLATIONS

Officers will monitor pedestrian and bicycle movements to ensure compliance with Maryland Vehicle Laws, especially regarding improper highway crossings by pedestrians. Enforcement action may be taken to curtail pedestrian / bicyclist movements that impede traffic and lead to accidents.

### 4-300.7 VEHICLE EQUIPMENT VIOLATIONS

The Maryland Safety Equipment Repair Order (SERO, Form #MSP 157, revised 11/98) may be issued when a vehicle is stopped for, or found to have, defective equipment. SERO's may be issued only for a motor vehicle or trailer which is assigned permanent Maryland registration plates.

#### 4.300.7.1 DISTRIBUTION

Safety Equipment and Repair Order distribution:

Given to Violator:

- Inspection Station copy (yellow)
- Owner copy (gold)
- Hard copy (buff)

Transmitted to Records:

- State Police copy (white)
- Officer's copy (pink)

### 4-300.7.2 CERTIFICATION OF SAFETY EQUIPMENT REPAIR ORDER

When a request for certification of a Maryland Safety Equipment Repair Order is made of a sworn member of the Agency, the following procedures shall be adhered to:

- Only those items on the form designated by an asterisk (\*) can be certified by a sworn police officer. If there is more than one cited for inspection and one of those items is not designated by an asterisk(\*), the inspecting officer shall refrain from certifying that item and advise the individual presenting the Safety



Administrative and Operational Manual

September 12, 2022

Equipment Repair Order to contact an authorized state inspection station.

- Certification of Maryland Safety Equipment Repair Orders should be performed at a district station; however, if an officer is approached while on patrol for this service, the officer will notify Communications of a call for service, then conduct the inspection and certification. Following the completion of the inspection, the officer shall make the required entries on the form and submit the police department copy to the Records Section prior to the end of the officer's tour of duty.
- Inspections generally will not be conducted during inclement weather or darkness unless the inspection can be appropriately completed.

**4-300.7.3 PROCEDURES FOR COMPLETING CERTIFICATION**

Upon determining that repairs are within lawful limits, the officer will enter the following information at the bottom of the SERO in the spaces provided:

- Officer's rank / signature / I.D.
- Date
- Charles County Sheriff's Office
- ZH for Agency code
- Mailing address of the Agency

**4-300.7.4 ISSUING CITATIONS FOR DEFECTIVE EQUIPMENT**

A Maryland Uniform Complaint and Citation may be issued to the operator of any motor vehicle or trailer which has defective equipment, as described in the Transportation Code of Maryland (TR ' 22). A Citation may be issued along with a SERO.

**4-300.8 REQUEST FOR RE-EXAMINATION OF DRIVER**

Routine traffic enforcement and motor vehicle crash investigations often lead to the discovery of drivers who have suspected incompetency, mental disability, disease or other conditions that might impair their abilities to exercise reasonable and ordinary care in operating a motor vehicle.

Maryland Motor Vehicle Law permits the Motor Vehicle Administration (MVA) to re-examine a person's driving privilege under the following criteria:

- the licensee is involved in a crash resulting in the death of another; and/or
- the administration has good cause to believe that the licensee is unfit, unsafe, or otherwise not qualified to drive.

If an officer has good cause to believe that a licensee needs to be re-examined, he will:

- complete a Request for Re-Examination of Driver (Maryland Form #AJ-39) being as specific as possible; and



Administrative and Operational Manual

September 12, 2022

- after supervisory / command review and approval, forward to the Motor Vehicle Administration by mail; and
- maintain the goldenrod copy of the form and any notes and other information concerning the incident so as to be able to answer questions posed by the licensee at a hearing.

**NOTE:** The MVA does not automatically notify an officer of the results of any re-examination. Officers may contact the MVA to find out the results.

## 4-301 PARKING VIOLATIONS

Parking violations will be issued on the Charles County, Maryland Citation Form when such violations are covered by the parking ordinance of Charles County, Maryland (Charles County Code, Chapter 287). Charging in this manner will cause the fine revenues to be retained by the Charles County Government for local use. The County parking citation may be used in the following instances, when a person:

stops, stands or parks a motor vehicle:

- in front of a public driveway; or
- on a sidewalk; or
- over a sidewalk; or
- in such a manner as to block a sidewalk; or
- in an intersection; or
- on a crosswalk; or
- on a two-way roadway with the left-hand wheels at the curb or roadway edge of the opposite direction lane; or
- where stopping, standing, or parking a vehicle is prohibited by an official sign; or

stands or parks a motor vehicle:

- at a curb indicated to be a fire lane, if properly signed; or
- in front of a private driveway without the consent of the owner or occupant of the premises; or
- within 20 feet of a crosswalk at an intersection; or
- within 30 feet of the approach to any stop sign, yield sign, flashing signal or traffic control signal located at the side of a roadway; or
- within 20 feet of the driveway entrance to any fire station or within 75 feet on the highway opposite to the driveway entrance, if properly signed; or
- on the roadway side of any other vehicle that is stopped or parked at the edge or curb of a highway; or
- on a curve or hill where solid lines on the surface of the roadway indicate a zone in which passing is prohibited; or
- on a one-way roadway with its right hand wheels more than 12 inches from the right- hand curb or edge of the roadway; or
- within 15 feet of a fire hydrant; or

parks a motor vehicle:



Administrative and Operational Manual

September 12, 2022

- within 50 feet of the nearest rail in a railroad grade crossing; or
- on any property owned by the Charles County Commissioners, Charles County Board of Education, or the Charles County Community College where parking is prohibited by an official sign; or
- stops, stands or parks a motor vehicle in a parking space for use of an individual with disabilities or otherwise reserved for the handicapped unless the vehicle bears a special registration plate, windshield placard, or other valid permit issued by the Maryland Motor Vehicle Administration, another state, or the District of Columbia.

The violation of any of these provisions is subject to a fine of \$20 for each violation, except the last, parking in a handicapped space, which subjects the violator to a \$500 fine. Each day of violation is a separate offense.

### 4-301.1 OFFICER'S CONSIDERATIONS

Officers are empowered to impound any vehicle which is parked in violation of any of the provisions of the County parking ordinance, providing that the vehicle is on a public road or parking lot and has been left so for an unreasonable time, impedes traffic or constitutes a threat to public safety. The law does not provide guidance as to what constitutes an unreasonable time. Officers may assume any vehicle parked in excess of 48 hours has been parked an unreasonable time if it was cited and remains in violation for that period of time.

Officers will present the violator's copy of the County parking citation, and the envelope designed to mail the fine to the Treasurer's Office, to the owner or operator if present when the officer writes the citation. In the instances where the vehicle is attended, the officer will request the driver sign the citation on the defendant's signature line. If a driver refuses to sign the parking citation, the officer will write the word "REFUSED" on the defendant's signature line and present the citation to the driver or place it on the vehicle.

For every citation (attended or unattended) the officer will sign the parking citation and place his ID number in the space following his signature. The ID number must be easily understood. If the owner or operator is not present, the officer will place the violator's copy and the envelope on the vehicle in a conspicuous place.

Officers will maintain the officer's copy of the citation for their records until any need for their appearance in court in the matter has passed. Officers must sign the citation affirming that the facts represented are true and correct. When officers place citations on a vehicle which is unattended, the registered owner of the vehicle is presumed to be the person receiving the citation.

Persons receiving citations may pay the fine to the Charles County Treasurer or elect to stand trial. If the violator does not notify the County Treasurer, within the 15 days of receiving the citation, of the need to have the officer present in court for a trial of the facts of the case, the officer's written citation will serve as prima facie evidence of the facts stated thereon.

### 4-301.2 PARKING CITATION INFORMATION

In cases where the vehicle is unattended, officers will fill in the sections of the parking citation for:

- vehicle registration number;
- state of registration;





Administrative and Operational Manual

September 12, 2022

---

- the name and address of the registered owner of the tag displayed and of the vehicle (**NOTE:** if the tags are issued to another vehicle, the proper enforcement action will be initiated and any evidence necessary for the prosecution will be gathered);
- the year, make, model and color of the vehicle,
- the date of the violation;
- the time of the violation;
- the location (to include street name and hundred block or cross street) where the vehicle was parked in violation;
- the specific parking violation that occurred; and
- the fine appropriate for the violation.

In cases where the vehicle is attended, the officer will additionally fill in the following information for the operator of the vehicle:

- the driver's license number;
- the class of the driver's license;
- the state in which the driver's license is issued;
- the driver's full name;
- the driver's current address;
- the city, state, and zip code of the driver; and
- the height, weight, race, sex, date of birth and telephone number of the driver.





Administrative and Operational Manual

September 12, 2022

---

[Redacted text block containing multiple paragraphs of blacked-out content]



Administrative and Operational Manual

September 12, 2022

[Redacted text block]

- [Redacted list item]
- [Redacted list item]
- [Redacted list item]
- [Redacted list item]
- [Redacted list item]
- [Redacted list item]
- [Redacted list item]
- [Redacted list item]
- [Redacted list item]
- [Redacted list item]

[Redacted text block]

[Redacted text block]

[Redacted text block]

[Redacted text block]

[Redacted text block]

[Redacted text block]

[Redacted text block]



Administrative and Operational Manual

September 12, 2022

[Redacted text block]

[Redacted text block]

[Redacted text block]

[Redacted text block]

[Redacted text block]

[Redacted text block]

[Redacted text block]

- [Redacted list item]
- [Redacted list item]
- [Redacted list item]
- [Redacted list item]

[Redacted text block]

[Redacted text block]

[Redacted text block]

[Redacted text block]

[Redacted text block]



Administrative and Operational Manual

September 12, 2022

[REDACTED]

[REDACTED]

[REDACTED]

[REDACTED]

[REDACTED]

[REDACTED]

[REDACTED]

[REDACTED]

[REDACTED]

[REDACTED]

[REDACTED]

[REDACTED]

[REDACTED]



Administrative and Operational Manual

September 12, 2022

[Redacted text block]

[Redacted text block]

[Redacted text block]

[Redacted text block]

[Redacted text block]

[Redacted text block]

[Redacted]	[Redacted]	[Redacted]	[Redacted]
[Redacted]	[Redacted]	[Redacted]	[Redacted]
[Redacted]	[Redacted]	[Redacted]	[Redacted]

[Redacted text block]

[Redacted text block]

[Redacted text block]

[Redacted text block]

[Redacted text block]



Administrative and Operational Manual

September 12, 2022

[REDACTED]

[REDACTED]

[REDACTED]

[REDACTED]

[REDACTED]

- [REDACTED]
- [REDACTED]
- [REDACTED]
- [REDACTED]
- [REDACTED]
- [REDACTED]

[REDACTED]

[REDACTED]

[REDACTED]

- [REDACTED]
- [REDACTED]
- [REDACTED]
- [REDACTED]
- [REDACTED]
- [REDACTED]

[REDACTED]

[REDACTED]





Administrative and Operational Manual

September 12, 2022

[REDACTED]

[REDACTED]

- [REDACTED]
- [REDACTED]
- [REDACTED]
- [REDACTED]

[REDACTED]

- [REDACTED]
- [REDACTED]
- [REDACTED]
- [REDACTED]

[REDACTED]

[REDACTED]

[REDACTED]

[REDACTED]

[REDACTED]

[REDACTED]

[REDACTED]



Administrative and Operational Manual

September 12, 2022

[REDACTED]

[REDACTED]

[REDACTED]

[REDACTED]

[REDACTED]

[REDACTED]

[REDACTED]

[REDACTED]

[REDACTED]

[REDACTED]

[REDACTED]

[REDACTED]

- [REDACTED]
- [REDACTED]
- [REDACTED]

[REDACTED]



Administrative and Operational Manual

September 12, 2022





## Administrative and Operational Manual

September 12, 2022

## 4-303 DRIVING WHILE INTOXICATED ARREST AND EQUIPMENT PROCEDURES

### 4-303.1 DWI ARREST-EVIDENTIARY CONSIDERATIONS

The officer must be able to prove that the defendant was either the driver or the person in control of a specific vehicle at a specific time. The officer must have either observed the defendant “behind the wheel” or have a credible witness available to verify the identity of the alleged operator. Any witness, including passengers, may be subpoenaed to court for testimony.

A chemical test should never be used alone to determine a suspect’s guilt. The arresting officer must have probable cause for effecting the arrest. The chemical test is only corroborative evidence and must be substantiated by other facts supporting the officer’s probable cause for arrest.

### 4-303.2 PRELIMINARY DWI ARREST PROCEDURES

When arresting an individual for a violation of the Transportation Article (TR § 21-902), officers will:

- Request that a chemical test be taken of the person’s breath to determine the correct blood alcohol content (see Section 303.4 for prerequisites to obtaining a blood test);
- Advise the individual of the administrative penalties that may be imposed for refusing to take a chemical test;
- Furnish the individual with a copy of his rights regarding submission to a chemical test—DR-15 (Current Version).

**Note:** This section does not apply to fatal crashes.

#### 4-303.2.1 DEFINITIONS

**BAC (Blood Alcohol Concentration)** – the number of grams of alcohol per 210 liters of breath [Transportation Article TR§ 11-103.2(a)(2)]

### 4-303.3 DWI DEFENDANTS INVOLVED IN FATAL CRASHES

If the operator of a motor vehicle is involved in a crash that results in the death of another person, and a police officer has reasonable grounds to believe that the operator has consumed an alcoholic beverage, the investigating officer shall make an attempt to have the operator submit to a Chemical Test for alcohol as directed by the officer as stipulated in the Transportation Article (TR § 16-205.1(c)(d)).

The test shall be administered pursuant to the provisions of the Courts and Judicial Proceedings Article (CJ § 10-304).

### 4-303.4 BLOOD TEST

Maryland law requires that the type of test to be administered shall be the chemical test of breath except that the chemical test for blood shall be administered if:



Administrative and Operational Manual

September 12, 2022

- The defendant is unconscious or otherwise incapable of refusing a breath chemical test for alcohol;
- The defendant's injuries require his removal to a medical facility; or
- The equipment used to administer the chemical test of breath is not available. **Equipment does not include an Intoximeter Operator.**

Blood tests may be administered when the defendant is involved in a crash involving a fatality or life-threatening injuries.

#### 4-303.5 FORMS TO BE COMPLETED

The Maryland Uniform Citation is the charging document in DWI arrests. When an individual has been arrested and charged with a violation of Article TR§ 21-902, the arresting officer will complete an Alcohol Influence Report Form 84. The results of the physical sobriety tests will be recorded on the Form DR-15, Advice of Rights for Chemical Test.

If the operator refuses to take the test or takes a test for alcohol which results in a 0.08 BAC or more, a Form DR-15A (officer's certification and order of suspension) will be completed in accordance with, and following the procedures set forth under the Administrative Per Se Law in Maryland:

- Statement of Probable Cause if defendant is taken before a judicial officer;
- Arrest Report;
- One (1) fingerprint card with palm prints;
- Crime Information Report;
- Storage Card if vehicle is stored.

#### 4-303.6 APPEARANCE BEFORE A DISTRICT COURT COMMISSIONER

The Transportation Article (TR § 26-202(C)) states that a person arrested pursuant to TR § 21-902 shall be taken, without unnecessary delay, before a District Court Commissioner, unless the officer releases the arrestee based upon a written promise to appear for trial.

Therefore, persons arrested for DWI will be taken before a District Court Commissioner unless the officer is satisfied that transportation is immediately available to the arrestee. Generally, this means that someone will respond to provide transportation for the arrestee.

#### 4-303.7 PHYSICAL SOBRIETY TESTS

Unless unwilling or unable, all persons suspected of violation of TR § 21-902 will be given a physical sobriety test. The specific tests utilized are the Horizontal Gaze Nystagmus, Walk and Turn and the One-leg Stand Test. Additional tests may be given at the officer's discretion. Tests should be administered in a level area.

**Horizontal Gaze Nystagmus**—Officers will give the following instructions:

- Place your feet together and hands by your side;
- Keep your head still and follow the stimulus with your EYES ONLY;
- Keep looking at the stimulus until you're told the test is over;
- Please do not move from this position until I tell you to;
- Do you understand?

**Walk and Turn Test**—Officers will give the following instructions:



Administrative and Operational Manual

September 12, 2022

- I am going to give you a test to check your balance.
- Please place your left foot on the line and then your right foot in front of it with your right heel touching your left toe (demonstrate).
- When told to begin, take nine (9) heel-to-toe steps down the line, turn around, and take nine (9) heel-to-toe steps back.
- In turning around, make your turn by pivoting on one foot, keeping it on the line and using your other foot to turn yourself around with several small steps (demonstrate).
- Keep your hands at your sides at all times, watch your feet at all times, and count your steps out loud. Do you understand?
- Begin and count your heel-to-toe steps aloud.

**One-Leg Stand Test**—Officers will give the following instructions:

- Please stand with your heels together and your arms at your sides, like this (demonstrate).
- When I tell you to, raise one leg about six (6) inches off the ground and hold that position for about thirty (30) seconds while you count aloud 1001, 1002, to 1030 like this (demonstrate).
- Do you understand?
- Begin by raising either your right or left foot and counting.
- Please lower your foot.

#### 4-303.8 COMPLETION OF DR-15 AND DR-15A FORMS

DR-15—Advice of Rights

DR-15A—Officer's Certification and Order of Suspension

Read the Advice of Rights from the MVA Form DR-15 or play the audible file from MVA website in the officer's presence.

A DR-15 will be completed on each operator charged with a violation of TR § 21 -902.

A DR-15A will be completed on each operator charged with a violation of TR § 21 -902 who refuses to submit to a chemical test to determine the alcoholic content of their blood. A DR-15A will also be completed in accordance with and following the procedures set forth under the Administrative Per Se Law of Maryland.

In completing the Reasonable Grounds section of the DR-15A, it is imperative that the following information be included:

- The driver was observed driving a motor vehicle at a particular location;
- The driver displayed a driving error (e.g., violation), or was identified as the driver in a collision (state how the driver was identified);
- The driver displayed observable signs of alcohol impairment (including the results of the physical sobriety tests, as well as the results of any preliminary breath test administered);
- The driver had an odor (specify degree if possible) of alcoholic beverage on their breath or person and/or admitted consuming alcoholic beverages, or was observed consuming alcoholic beverages; (**Note:** The words "alcoholic beverage" must be listed in the Reasonable Grounds section).
- If there is insufficient space for the officer to record the reasonable grounds for arrest in the Reasonable Grounds section, he will write the additional facts on plain paper. The accused will be identified by name and citation number.

**Administrative and Operational Manual****September 12, 2022****4-303.9 TIME LIMIT FOR ADMINISTERING TEST**

Section 10-303 of the Courts and Judicial Proceedings (CJ § 10-303) states “the specimen of breath or blood shall be taken within two (2) hours after the person is apprehended.” The time of apprehension is the functional equivalent of the time the violator was stopped or detained.

Circumstances may arise which complicate the consent procedures, such as when the violator repeatedly changes his mind concerning submission to the test. Officers faced with this type of situation shall accommodate only reasonable requests provided that the two (2) hour time limit does not expire. Officers will advise violators that failure to take a chemical test due to such evasive behavior will be treated as a refusal.

If such actions on the part of a violator cause the two (2) hour time limit to lapse without the administration of a chemical test, and the officer believes that these actions were taken purposefully to evade the testing procedure, the officer shall treat this as a refusal. In addition to the DR-15A, the officer shall submit a letter containing the actions of the violator which enabled the violator to evade a chemical test. This letter will be mailed to the Review and Reinstatement Section of the MVA, 6601 Ritchie Highway, N.E., Glen Burnie, Maryland 21016.

Situations may arise in which the violator states that he will submit to a chemical test, but only after conferring with or in the presence of his lawyer. Officers shall allow the violator the opportunity to contact his attorney. However, violators shall be advised that a refusal to submit to a chemical test due to the inability to contact or produce the attorney's presence within the necessary time limit will result in the same sanctions as a refusal to submit to a chemical test.

Situations may arise in which, due to no delay on behalf on the violator, a violator is not presented for the test until after the two (2) hour limit has passed. In such cases, the test will still be administered. These tests lose their prima facie value, but can still be used in court. In such cases, the arresting officer shall notify the State's Attorney's Office and alert them to facts of the cases.

**4-303.10 MIRANDA WARNING AND QUESTIONING**

Following completion of the DR-15 procedures, the arresting officer may then read the Miranda warning to the defendant and request a statement concerning his activities prior to the arrest, *i.e.*:

- Where he had been prior to the arrest;
- What he had to drink prior to the arrest;
- How much he has had to drink prior to the arrest;
- How long he had been drinking prior to the arrest.

**4-303.11 ARRESTING OFFICER'S TEST PROCEDURES**

Request an Intoximeter operator as soon as possible.

Prevent the accused from eating, drinking or smoking or ingesting medication. Accused should be observed for a twenty (20) minute period prior to the taking of the breath sample to ensure this.

**4-303.12 INTOXIMETER OPERATOR TEST PROCEDURES**

All Intoximeter operators will strictly follow the procedures and guidelines established by the State Toxicologists. This program within the Agency shall be monitored by the designated Intoximeter Supervisor who shall report any non-conformities to the Commander of the Special Operations Division. The Commander, Special Operations Division or his designated Assistant Division Commander shall retain command supervisory responsibilities over all areas of the Intoximeter Program for this Agency.



Administrative and Operational Manual

September 12, 2022

**Note:** The arresting officer shall not administer the Chemical Test for Breath.

### 4-303.13 DISTRIBUTION OF MSP FORM 33

This form contains the results of the chemical test. Upon receipt, distribution shall be as follows:

**Original** –retained in Records for court presentation by arresting officer.

**First copy** – forwarded to State’s Attorney’s Office by Records Management personnel.

**Second copy** – given to the defendant by the arresting officer.

**Third copy** – submitted to MVA only if DR-15A is utilized.

### 4-303.14 BLOOD TESTS

The chemical test of blood shall be performed only when:

- The defendant is unconscious or otherwise incapable of refusing to take a breath chemical test for alcohol; or
- Injuries to the defendant require his removal to a medical facility; or
- The equipment for administering a chemical test for breath is not available.

Blood tests may be administered when the defendant is involved in a crash involving a fatality or life-threatening injuries (see Section 4-303.3).

The sample of blood must be drawn with approved equipment by qualified personnel.

Only those blood kits authorized by the State Toxicologist and distributed by the Chemical Test for Alcohol Unit of the Maryland State Police will be used.

### 4-303.15 BLOOD ALCOHOL KIT CONTENTS

- White mailer box;
- Plastic box with lid;
- MSP Form 34—Alcohol Analysis—Medical Personnel Payment Authorization;
- Police officer’s report;
- Blood collection report and consent form;
- Swab pad;
- Two vacutainer tubes;
- Clear plastic envelope;
- One needle with holder;
- Seals;
- Instructions.

### 4-303.16 GENERAL BLOOD SAMPLE PROCEDURES

Because of restrictions placed on military personnel, a blood sample taken at a military hospital cannot be submitted to a local law enforcement officer for evidentiary purposes.





Administrative and Operational Manual

September 12, 2022

Because of legal restrictions, blood tests administered in the District of Columbia or the Commonwealth of Virginia may be inadmissible as evidence.

The sample of blood must be drawn with approved equipment by qualified personnel.

One (1) sample of two (2) test tubes is required. The two (2) sample test tubes must be completely filled.

Complete DR-15 and Form 84 (Alcohol Influence Report).

Complete Consent Form. If individual refuses to sign, enter "refused to sign" on form.

The swab provided in the kit must be used. This swab contains no alcohol, therefore, will not contaminate the results.

**Note:** The packet containing the swab and needles used by qualified personnel will be discarded in accordance with medical procedures.

Follow directions contained in blood collection kit.

Upon completion, package and label properly, place kit in pre-addressed mailing container and forward to Records Management for mailing.

The arresting officer will complete the following and submit to Records Management:

- Alcohol Influence Report;
- Arresting officers copy of MSP Form 34 (Current Version)—Alcohol Analysis—Medical Personnel Payment Authorization;
- Consent Form; and
- Officer's copy of DR-15 (Current Version).

Upon receipt of the results, a supplemental report to the Alcohol Influence Report Form 84 will be completed noting the test results. If the test indicates a reading of 0.08 BAC or higher, the Form DR-15A will be completed. The driver will be contacted and will sign all copies of notification. Once completed, all forms will be returned to Records Management.

If appropriate, charges will be applied for after the test results are received. If the accused is charged via citation or criminal summons and no physical arrest occurs, the investigating officer will contact the State's Attorney's Office and request a petition for court ordered fingerprinting. Upon the accused being charged, the case will be closed with a supplemental report.

#### **4-303.17 DR-15A PROCESSING AGREEMENT WITH MARYLAND TRANSPORTATION AUTHORITY (TOLL FACILITIES POLICE) WITH ATTACHMENT 1 AND 2**

An agreement has been made between this Agency and the Maryland Transportation Authority whereby residents of Charles County who are arrested by Toll Facilities Police for alcohol violations and a blood test is taken, which results in a 0.08 BAC or more, that agency will forward the partially completed DR-15A and a copy of MSP Form 33 to this Agency for service.

These documents will be forwarded to Records Management for processing.



Administrative and Operational Manual

September 12, 2022

## 4-303.18 PROCESSING DRUG SUSPECTS

Individuals suspected of driving while under the influence of drugs shall be processed in the same fashion as persons driving under the influence of alcohol.

If the suspect selects a chemical test, these tests can be used to determine the extent of alcoholic influence.

- A low test result, together with the officer's observations, may support the probability of drug use.

Drugs found on the suspect or in his vehicle will be corroborative evidence in determining his guilt. Prescription medicine is no defense against a charge of driving while intoxicated.

Procedures for analysis of drugs set forth in this Manual will be followed.

The Transportation Article (TR § 21-902(c)) will be used for charging a violator with driving under the influence of drugs or a combination of drugs and alcohol.

If evidence of an illicit drug is obtained, the violator may be charged with TR § 21-902(d)—Driving Under the Influence of a Controlled Dangerous Substance.

## 4-303.19 SUMMONSING OF WITNESSES

The arresting officer shall cause all essential witnesses to be subpoenaed to court by checking the witness block and completing the back of the first copy of the Maryland Uniform Citation.

## 4-304 INTOXIMETER

### 4-304.1 ROUTINE DUTIES OF INTOXIMETER OPERATOR

Each operator shall maintain at his assigned station an Intoximeter Operator's Log (MSP Form 36A).

All tests conducted by that operator (defendant tests and simulator tests) shall be recorded in the log as soon as practical. These tests must also be recorded in the appropriate Log of Tests for Alcohol Influence Arrests (MSP Form 36B).

Each operator is required to run a minimum of one (1) test per month, either subject test or simulation; four (4) subject tests are also required per year. These will be listed on the Operator's log. Special exceptions to this regulation will be allowed because of sick and safe leave, annual vacation, temporary assignment outside of the area, or the absence of the instrument due to repairs. The reason for failing to perform the required tests will be entered on the Intoximeter Operator's log.

The Operator's log will be maintained by the operator for the purposes of establishing a permanent record of his testing experience in court.

### 4-304.2 INTOXIMETER SUPERVISOR

The Intoximeter Supervisor will be responsible for:

- Ensuring the certification letter from the State Toxicologist is available for court;
- Ensuring adequate supplies are maintained to keep the instrument in operation;



**Administrative and Operational Manual**

**September 12, 2022**

- Ensuring the Log for Alcohol Influence Arrests is with the instrument;
- Ensuring each Intoximeter Operator is complying with the Agency rules and regulations, as well as those regulations set forth by the State Toxicologist;
- Periodic inspection of the Log for Alcohol Influence Arrests (MSP 36B) to ensure that it coincides with the Operator's log (MSP 36A);
- Ensuring sufficient current Blood Test Kits are available at the Agency;
- Examining the Intoximeter Operator's Log (MSP 36A) for each operator to ensure that the required simulator and/or defendant tests have been conducted;
- Submitting the appropriate reports to the Chemical Test for Alcohol Unit, the State Toxicologist and the Agency's division commanders;
- Coordinating training for personnel with Maryland State Police;
- Maintaining copies of all blood test results.

### **4-304.3 CERTIFICATIONS OF INTOXIMETER**

By law, all Intoximeter instruments must be certified by the Toxicologist of the Office of the Chief Medical Examiner of Maryland.

All new Intoximeters will be certified prior to assignment in the field.

All Intoximeters will be recertified semi-annually on a schedule to be announced by the Office of the State Toxicologist.

All Intoximeters sent to the factory for repairs must be recertified prior to reassignment in the field.

## **4-305 RADAR**

### **4-305.1 RESPONSIBILITIES OF THE TRAFFIC OPERATIONS SUPERVISOR PERTAINING TO POLICE TRAFFIC RADAR AND SELECTIVE ENFORCEMENT**

The Traffic Operations Supervisor will maintain a current knowledge of new technology and radar equipment as well as recent court decisions and/or legislation relating to police radar operations. All studies, evaluations and selections of radar equipment used by the Agency will be accomplished by the Traffic Operations Supervisor. As part of the selection process, the "Police Radar Approval List" published by the National Highway Traffic Safety Administration will be consulted. Additionally, the Traffic Operations Supervisor will:

- Maintain a current inventory of all Agency radar equipment;
- Authorize the use of any radar equipment personally owned by an officer;
- Arrange for yearly calibration on all radar devices and tuning forks;
- Maintain calibration and service records on all radar units;
- Arrange for the service or repair of radar units as needed;
- Maintain a list of Agency radar operators and the equipment each has been certified to use;
- Investigate unauthorized or indiscriminate use of radar equipment when directed by the Patrol operations commander.

The Traffic Operations Supervisor will have the following responsibilities pertaining to selective enforcement activities utilizing police radar:



Administrative and Operational Manual

September 12, 2022

- Identify areas in need of selective enforcement and coordinate the response. This information will be provided to district commanders for their appropriate action;
- Maintenance and analysis of all selective enforcement activity records.

#### 4-305.2 ISSUANCE AND CUSTODY OF RADAR UNITS

Each radar operator is solely responsible for the proper care and control of any radar unit and its accessories during which time it is assigned to him/her. During monthly vehicle inspections, supervisors will account for issued radar equipment and note their observation on the Vehicle Inspection Form.

When not in use, a radar device will be properly stored in the carrying case. A mounted device may be left in its operating position. Mounting accessories will not be modified unless approved by the Traffic Operations Supervisor. Due care must be observed when installing the mounting accessories so as not to interfere with the vehicle's operation or safety devices.

Indiscriminate and/or careless radar enforcement or abuse of equipment will not be tolerated and may result in appropriate disciplinary action.

#### 4-305.3 RESPONSIBILITIES AND GUIDELINES FOR THE RADAR OPERATOR

Radar operators must complete approved training (MPTC) and be certified with the speed monitoring device(s) utilized.

All safety specifications outlined by the manufacturer of the radar equipment will be observed. At a minimum, Agency safety regulations will be followed and require:

- the radar device to be turned off when not in use;
- antenna to be pointed away from the operator's body;
- handheld units are not to be placed in the operator's lap or against the body.

Prior to beginning any type of radar enforcement, the operator will conduct a proper test of the equipment being used.

Each radar operator will maintain the necessary records and tracking history following any traffic arrest through the use of radar for the successful prosecution of accused speeding violators. When having to appear for court regarding a traffic arrest involving police traffic radar, an operator will have in his possession the appropriate file and records pertaining to that radar device. A copy of radar certification files are available at the front desk of District I. Radar operators will also have their Operator's Certification card whenever appearing in court or conducting radar operations.

Radar operators will be responsible for the certification of police vehicle speedometers in accordance with Section 4-223.2. Operators will not certify or check any non-police vehicle speedometer. Citizens requesting service of this nature will be referred elsewhere, i.e., automobile dealership, private business.

Radar operators will receive all selective enforcement assignments from their respective district commanders during normal shifts. Additional instructions may be forwarded to radar operators from the Traffic Operations Supervisor,



**Administrative and Operational Manual**

**September 12, 2022**

---

who will have prior approval from the district commander or the Patrol operations commander.

The nature and severity of the violation and/or existing conditions will be considered when determining enforcement tolerance. Operators will balance their enforcement actions in accordance with Section 4-300.

Radar operators, when functioning alone or in conjunction with a stopping team operation, will allow for the safety of other motorists when pursuing or apprehending the speeding violator. Stationary positions will have a sufficient area for violators to be safely stopped while not interfering with the normal flow of traffic.

**4-305.4 SPECIAL OPERATIONS USING POLICE TRAFFIC RADAR**

Officers working radar assignments as part of any target program or special operation will comply with instructions outlined by the Traffic Operations Supervisor. All activity reports, including overtime request forms, will be submitted directly to the Traffic Operations Supervisor.



Administrative and Operational Manual

September 12, 2022

---

## 4-306 PROCEDURES FOR ORGAN DONORS

The driver's license of a person killed in an automobile accident should immediately be checked to determine if the victim is an organ donor.

When such an individual is identified, the organs most likely to be donated would be the corneas, for which the Medical Eye Bank is responsible and which are viable for use to 12 hours postmortem, and the kidneys, for which the transplant program's organ procurement teams are responsible and which are viable for less than one-half hour after circulation ceases. It is obvious that no significant delay can be tolerated.

There are three organ procurement teams, one associated with each of the transplant programs at University of Maryland Hospital, Johns Hopkins Hospital and Baltimore City Hospital. Assistance may be obtained by calling the following:

- Johns Hopkins: 410-955-6070
- University of Maryland: 410- 528-5720

Any officer calling either number with the simple statement that he wishes information regarding an organ donor will receive a prompt response. The transplant team will, if the patient is far from us, contact knowledgeable teams in hospitals close to the donor who will be able to recover the organs for transplant.



## Administrative and Operational Manual

September 12, 2022

## 4-307 MOTOR VEHICLE SOBRIETY CHECK POINTS

Sobriety check points can be highly effective in reducing alcohol-related motor vehicle crashes and are a successful short-term deterrence to drunk driving. The CCSO is concerned with alcohol-related traffic injuries and fatalities. As a result we will follow the recommendations of the National Highway Traffic Safety Administration (NHTSA) to conduct check points on a periodic and continuing basis as a part of a comprehensive Impaired Driving enforcement program.

Check point locations and times will be selected based primarily on the number of alcohol / drug related crashes occurring in the area of those locations. Other factors may include the frequency of DUI arrests, and/or complaints from citizens and community officials. The relative safety of CCSO personnel and the citizens will also be a primary consideration in selecting a check point site. Information used as the basis for the selection of specific check points shall be recorded and maintained by the supervisor of the Traffic Operations Unit.

Check point operations will be approved by the Commander, Field Operations of the Special Operations Division or a designee. The supervisor of the operation will submit a Special Events Plan, Form #846a, in advance through the chain of command. The State's Attorney's Office will also be contacted and advised of the operation in advance.

### 4-307.1 PROCEDURES

Sobriety check points conducted by CCSO personnel will be done in a manner consistent with federal and state court rulings. The media will be contacted and advised prior to the operation occurring. Check point sites selected shall have a safe area for stopping motor vehicle traffic and afford a driver the opportunity to take an alternate route of travel if they wish not to participate. The selected site shall have sufficient visibility that allows drivers to safely stop upon observing the stopping team. A supervisor of the rank of Sergeant or Corporal with Check Point Management training will oversee the operation and an adequate number of personnel trained in sobriety detection will staff the site. Additional support personnel should be in place, to include a breath test operator.

Each check point operation will start with a briefing to all personnel involved. The briefing will include an introduction of all participants and an explanation of each duty assignment and responsibility. Observers from the State's Attorney's Office, media, community leaders, and support organizations are encouraged to attend a check point, and should attend the briefing.

All line (contact) officers will be in the uniform of the day. All participants, including civilian personnel, will wear a reflective safety vest while at the check point site; and at least one (1) marked patrol car will be on the scene. A sobriety check point sign will be placed ahead of the check point in a location which allows a driver of a motor vehicle to choose an alternate route instead of participating in the check point. Traffic cones, flares, and warning devices will be used to identify the check point site and establish traffic lanes.

Vehicles will be stopped on a systematic, non-random basis. All vehicles entering the check point will be stopped. If traffic becomes congested to a point where motorists are unreasonably inconvenienced, the operation will be temporarily stopped and traffic allowed to proceed without being checked.

The initial stop and contact by an officer will be brief and last approximately one (1) minute or less. Officers will:

- identify themselves;
- state the reason for the stop;
- thank all drivers for their cooperation and give them a pamphlet on impaired driving and sobriety check-points.

Line officers who make contact with a driver will attempt to identify articulable signs of impairment. If during the initial contact with the driver, an officer does not develop reasonable suspicion to conduct a sobriety test or if no



Administrative and Operational Manual

September 12, 2022

probable cause exists of another crime, the motorist will be instructed to proceed. If reasonable suspicion does exist or probable cause is developed of a crime occurring, the driver will be instructed to park at a pre-determined location and an investigation will continue accordingly.

Persons arrested at the check point will be transported to a CCSO or MSP facility for testing and processed in accordance with procedures established elsewhere in the AOM.

#### 4-307.2 AFTER ACTION CRITIQUE

The supervisor of the check point will complete an After Action Special Event Report Form #846 and a Crime Information Report at the conclusion of the operation. These reports will include the following:

- date, time and location of the check point;
- number of vehicles checked;
- number of arrests and description of charges;
- any unusual occurrences.

#### 4-309 TRAFFIC DIRECTION

Officers shall provide manual traffic direction as assigned or on the scene of any incident that disrupts the normal flow of traffic. Incidents that may require officers to direct traffic can include:

- motor vehicle or other accident scenes;
- major fire scenes;
- adverse road and weather conditions;
- power outages or malfunctioning traffic lights; and
- large scale special events.

Manual traffic direction can include the use of highway flares, traffic cones, stanchions or barriers. Whenever the need for traffic direction may exceed one hour, officers may request assistance from County Roads or the State Highway Administration in providing temporary traffic control devices or in manually operating electronic signal boxes.

Officers directing traffic utilizing hand signals will do so in accordance with procedures taught in initial training. A minimum of two officers should be assigned to direct traffic at major intersections.

Officers shall at all times while directing traffic wear the issued traffic safety vest. Additionally, during periods of inclement weather and darkness officers shall use flares, traffic wands or other visibility aids to assist in directing traffic.

#### 4-309.1 NOTIFICATIONS REGARDING ROAD CLOSURES

Charles County Sheriff's Office will cooperate with Charles County Government regarding the Citizen Notification System (CNS). It will be the responsibility of the Police Communications Supervisor or Acting Police Communications Supervisor to submit information regarding any road closures (county or state) and/or urgent matters as deemed appropriate for citizens' knowledge, to the Command Staff, to the county, as well as to the State Operations Center (SOC). The PCS will also be responsible to enter into the CNS any information provided to this Agency from other law enforcement agencies, such as MSP, concerning road closures.





## OFFICE OF THE SHERIFF, CHARLES COUNTY, MD



737

### Administrative and Operational Manual

September 12, 2022

---

The Command Staff, CNS and SOC will be immediately updated by the Police Communications Supervisor when there is any change in an incident status.



## Administrative and Operational Manual

September 12, 2022

## 4-310 EVENTS / INCIDENTS / AFTER ACTION REVIEW

### 4-310.1 DEFINITIONS

The After Action Review as described in this section refers to large scale events and incidents and does not change the use or references to After Action Reports as found elsewhere in the AOM.

**After Action Review:** An After Action Review (AAR) is a professional discussion of an event that focuses on performance standards and enables development professionals and colleagues with similar or shared interests to discover for themselves what happened, why it happened, and how to sustain strengths and improve on weaknesses. The AAR tool affords leaders, staff, and partners an opportunity to gain maximum benefit from every program, activity, or task. It provides:

- candid insights into specific strengths and weaknesses from various perspectives;
- feedback and insight critical to improved performance;
- details often lacking in evaluation reports alone.

The AAR is the keystone of the process of learning from successes and failures. An After Action Review must be completed for all events / incidents that may:

- adversely impact large segments of a community;
- have multiple operational periods;
- involve multiple departments / agencies in the response;
- impact critical infrastructure and the local economy; or
- be likely to attract considerable media attention.

**Event:** An event is a planned, non-emergency activity. An event may include a wide range of situations, such as parades, concerts, or sporting events.

**Incident:** An incident is an occurrence, natural or man-made, which requires an emergency response to protect life or property. Incidents can, for example, include:

- major disasters
- emergencies
- terrorist attacks
- terrorist threats
- wildland and urban fires
- floods
- hazardous materials spills
- nuclear accidents
- aircraft accidents
- earthquakes
- hurricanes
- tornadoes
- tropical storms
- war-related disasters
- public health and medical emergencies
- other occurrences requiring an emergency response

**Incident Action Plan:** An Incident Action Plan (IAP) may also be referred to as an Event Action Plan. An IAP is a written plan containing general objectives reflecting the overall strategy for managing an incident. It may include the



Administrative and Operational Manual

September 12, 2022

identification of operational resources and assignments. It may also include attachments that provide direction and important information for management of the incident during one or more operational periods.

### 4-310.2 EVENT PROCEDURE

The Commander, Special Operations Division will be the designated coordinator for the planning of Agency presence at all events. The Commander, Special Operations Division will be responsible for the completion of and distribution of an IAP for all events. The IAP should be in the format described in the Charles County Sheriff's Office All Hazards Plan. For large events that may require an After Action Review, the Charles County Incident Management Team should be considered. The Commander, Homeland Security and Intelligence Section will be responsible for completing and publishing a Threat and Hazard Identification and Risk Assessment for each event. The Assessment will be included in the IAP.

### 4-310.3 INCIDENT PROCEDURE

Incidents which should be managed using the Incident Command System may:

- adversely impact large segments of a community;
- have multiple operational periods;
- require multiple departments / agencies to be involved;
- impact critical infrastructure and the local economy; or
- be likely to attract considerable media attention.

Incidents which meet the above criteria will require an After Action Review and report.

### 4-310.4 EVENT / INCIDENT CONCLUSION

At the conclusion of the event / incident, an after-action meeting should be scheduled. The Commander, Homeland Security and Intelligence Section will organize and facilitate the after-action meeting and complete the required report. The report shall be submitted as soon as practicable after the meeting. The After Action Report should include:

- Event / Incident Overview
  - Date
  - Time / operational periods
  - Personnel assigned
  - Allied agencies involved
  - Any equipment used
  - Cost / overtime / equipment
  - Overview of planning process / command structure
- Event / Incident Objectives
  - Only if published
- Areas of Improvement



Administrative and Operational Manual

September 12, 2022

- Identified during after-action meeting
- Identified mitigation strategies
  
- Successes
  - Identified in the after-action meeting

The completed After Action Report should be disseminated to the event / incident commanders and appropriate executive staff members.

## 4-400 VEHICLE CRASHES

Maryland law (§2-306 of the Public Safety Article of the Maryland Code) requires that law enforcement agencies furnish information relative to vehicle crashes to the Department of State Police. The State Police are charged to collect, analyze, and disseminate that information. The personnel of the Charles County Sheriff's Office shall investigate crashes which come to their attention and gather that information, in accordance with the requirements of this section.

Crash reporting data entered in the Automated Crash Reporting System (ACRS), a program and crash database developed and administered by the Maryland State Police (MSP), is automatically collected by MSP once the report passes through the Charles County Sheriff's Office supervisory approval process.

In addition to the responsibility to gather information concerning crashes, officers are charged to protect the public by providing for an orderly flow of traffic. One of the methods of doing that is to identify persons who cause crashes because of their violation of the Vehicle Law. These persons, when identified, may then be brought to the attention of the Courts and the Motor Vehicle Administration.

There is also a public benefit to be obtained from the statistical data gathered by police in the formal investigation of crashes. That data may then be used to:

- determine the need for selective enforcement at various sites;
- provide for new traffic control devices and highway engineering improvements;
- aid in the development and improvement of driver education programs; and
- provide guidance to legislators in determining the need for new or revised traffic control laws.

### 4-400.1 RESPONSIBILITIES OF RESPONDING OFFICER

An officer who is dispatched, or who is otherwise the first officer at the scene of a crash, will ensure the following, as may be appropriate to the particular scene:

- that measures are taken to prevent the crash scene from becoming worse, e.g., the cruiser is placed to alert oncoming traffic, road flares are set, traffic direction is initiated, etc.;
- that persons involved are checked for injuries, emergency aid is given for life-threatening injuries and paramedics and ambulances are summoned;
- that fire hazards are identified, persons are protected from them and the Fire Department is summoned to deal with them;
- that hazardous cargos and material are detected and steps taken to protect the public and deal with their containment and removal;



Administrative and Operational Manual

September 12, 2022

- 
- that the bodies of persons killed are checked for the presence of evidence of organ donor information and if such is found, it is brought to the attention of medical personnel;
  - that, as needed, additional assistance is summoned;
  - that short-lived evidence (skid marks, debris, vehicle position, etc.) is preserved;
  - that principals and witnesses are identified for later interview;
  - that the driver's license, vehicle registration information, and insurance information of the drivers and vehicles involved are collected;
  - that the condition and extent of damage of each of the vehicles involved is examined;
  - that the roadway and objects adjacent thereto which may have been damaged as a result of the crash are identified;
  - that any continuing hazards associated with the crash scene are reported to the responsible agency and the public protected from such hazards by warning signs, barricades, etc., until such hazards are dealt with;
  - that during the handling, clearing, and investigating of the scene of the crash, there are provisions made for the orderly and expeditious flow of traffic around the scene, or that such detour as may be needed to avoid the scene is made;
  - that an official report be made of the facts and circumstances of the crash in accordance with Section 4-400.2 below; and/or
  - that the provisions of the Memorandum of Understanding with the State Police outlined in Chapter 3, Section 150, regarding crashes, are complied with. In this regard, if this Agency would not complete an investigation and report, the State Police will probably not either, since our reporting requirements are similar. In these cases, the officer on the scene may handle the incident without requesting State Police.

#### 4-400.2 REPORT REQUIREMENTS

An official crash report shall be required in all cases where the crash involves at least one motor vehicle, occurred within the jurisdiction of the vehicle laws, i.e., on a highway, on private property that is used by the public in general, on property owned or under the control of the State, political subdivisions, County boards, schools, etc., or falls under the provisions of a law applicable to anywhere in the State (DWI), and:

- there is a death or likelihood of death as a result of the crash;
- there are injuries to any person or injuries are claimed by any person as a result of the crash;
- there will be placed charges of violation of the vehicle or other laws as a result of the crash;
- there is impropriety in registration, insurance, or licensing of any driver or vehicle;
- the crash involves any bus, train, government vehicle or aircraft;
- the crash involves any hazardous material (as defined in the Emergency Handling of Hazardous Materials



**Administrative and Operational Manual**

**September 12, 2022**

in Surface Transportation handbook) dangers;

- there is damage to any government or public utility owned property, e.g., guardrail, telephone or lamp pole, traffic control sign, barrier, etc.;
- there is a collision with a building resulting in any damage to the building;
- the damage to any one of the motor vehicles involved is of such an extent that the vehicle cannot be safely operated from the scene of the crash; or
- the driver of any motor vehicle left the scene of the crash (hit and run); and
  - an officer was called to the scene of the hit-and-run crash; and
  - there is investigable evidence that a hit-and-run occurred.

If the conditions set forth above do not exist, the officer may elect not to investigate the crash and no report will be written. In these cases, the officer will give the principals a copy of a Motor Vehicle Collision Information Exchange Form, which is produced through the ACRS system. In these cases, the officer should be sure that the principals understand that they will not be able to obtain a police report, as none will be written.

### **4-400.3 ESTABLISHING INVESTIGATIVE RESPONSIBILITY**

The responsibility for the investigation of a vehicle crash will normally be that of the officer assigned the patrol responsibility for the geographical area (Patrol Sector) containing the crash scene. That officer and/or supervisory personnel may make a determination that the crash would be more appropriately investigated by alternate personnel.

For example, under the Memorandum of Understanding with the Maryland Department of State Police, a crash occurring on a State highway might be investigated by the State Police. In another case, a crash may be of such magnitude or circumstances that the need for crash reconstruction is evident.

A Reconstructionist may be summoned to handle the crash. In such cases, the summoned investigator must acknowledge the intent to assume the responsibility for the crash. In any case, the first officer on the scene of a crash must assume responsibility for the scene until relieved of that responsibility by the investigating officer or a superior officer.

### **4-400.4 INVESTIGATOR'S RESPONSIBILITIES**

When an investigation and report are required under this section, to the degree possible, given the circumstances of the crash, the responsible officer will complete, at least, the following tasks:

- a crash report shall be completed in accordance with the requirements and instruction provided by the ACRS Manual;
- the facts and circumstances concerning the crash will be learned through the interview of witnesses and principals;
- document all identified witnesses within the ACRS in the appropriate reporting field. Witness statements relevant to the crash should be summarized within the ACRS report narrative.
- the physical evidence will be examined, collected, and photographed. Photographs are required in any case where a crash report is completed.



**Administrative and Operational Manual**

**September 12, 2022**

- 
- the documents, licenses, registrations, and the like will be examined and, if necessary for evidentiary purposes, collected and preserved;
  - measurements sufficient to complete an accurate diagram of the crash, to include at least the positioning of the vehicles, points of impact, and evidence position and size will be taken;
  - if the driver / owner / custodian of any vehicle is unable or not present to assume responsibility for an involved vehicle, the vehicle will be inventoried and impounded for safe keeping and/or to prevent its posing a roadway hazard;
  - any obviously valuable property, which the occupant of any vehicle is unable to protect because of injuries, will be collected as would any found property and handled according with policy found in Chapter 4, Section 500;
  - the roadway and objects adjacent thereto which may have been damaged as a result of the crash shall be reported to the owner or State or Local responsible agency;
  - if information and evidence present allow for a determination of cause, and probable cause exists to place charges, the officer may cite violators (in such cases, if the officer did not witness the crash, witnesses will be summonsed);
  - provide persons involved with a copy of a Motor Vehicle Collision Information Exchange Form, which is produced through the ACRS system; and
  - if the crash involved a fatality or a significant injury requiring advanced investigation, the Traffic Operations Unit will be summoned to assume responsibility of the investigation.

#### **4-400.5 SUPERVISOR'S RESPONSIBILITIES**

In all cases involving the coordination of many Agency resources or the use and direction of many personnel, a supervisor will respond and assume overall handling of the scene unless and/or until relieved of such responsibility by higher authority.

Supervisors will ensure that all crash reports are completed by the end of the investigator's tour of duty unless the extent of the crash or extenuating circumstances makes this impractical. In such cases, the supervisors may authorize the holding of the report for no more than seventy-two (72) hours. If a report cannot be completed within the seventy-two (72) hour hold period, the incomplete report will be submitted followed by a supplement(s) as necessary. In any case of an incomplete report, supervisors will monitor the status of the investigation and assure its proper and timely conclusion.

#### **4-400.6 HIT & RUN AND OTHER FOLLOW-UP INVESTIGATION**

Most hit and run crashes will require some follow-up investigation. Some very involved and serious crashes may require follow-up investigation. Unless there is a fatality involved, the responsibility of the follow-up investigation will be that of the original investigating officer.

In the case of a hit-and-run crash, an officer is not required to write an ACRS report if they are not called to the scene of the crash and there is no investigable evidence or witnesses to the crash. If an officer does not complete an ACRS report, the officer shall give the vehicle driver the event number (CAD "S" number) to verify that they contacted the CCSO concerning the hit-and-run. This should be noted in the event notes in the CAD.



## Administrative and Operational Manual

September 12, 2022

In fatality cases, Traffic Operations will be summoned to assume responsibility of the investigation.

In all hit and run crashes where investigative leads exist, the original investigating officer will, to the extent that is reasonably possible, pursue the existing leads. Supervisors of these officers will monitor the follow-up investigation in order to balance the requirements of the investigation against the need of the officer's services to respond to calls or other responsibilities of the work group. The supervisor will see that a supplement is submitted when the investigation is complete, when investigative leads are exhausted or when the investigation is no longer active for other reasons.

#### **4-400.7 ALCOHOL RELATED FATAL OR LIFE THREATENING CRASHES**

If the operator of a motor vehicle is involved in a crash that results in the death of, or a life-threatening injury to, another person, and the operator is detained by an officer who has reasonable grounds to believe that the operator was operating or attempting to operate while under the influence of, or intoxicated by alcohol or drugs, then the investigating officer shall have the operator submit to a test for alcohol as stipulated in the Maryland Transportation Article (TR § 16-205.1 (c) & (d)). The test shall be administered pursuant to the provisions of the Courts and Judicial Proceedings Article (CJ § 10-304).

Life-threatening injury is not defined in the law for this section; therefore, the officer should use his knowledge and training as a first responder to determine the extent of the injuries if emergency medical personnel are not present or otherwise able to make a determination of the extent of a victim's injuries. Some injuries, such as arterial bleeding, stoppage of breathing, cardiac arrest and severe head injuries which cause unconsciousness and probable brain damage can be assumed by the officer to be life threatening.

The nature of the terms of the phrase "required to submit to a test, as directed by the officer" have not been defined by statute or case law at this time. These terms, which appear in the Transportation Article (TR § 16-205.1 (c)) place some burden upon the officer to have a test administered in the referred to cases. The officer should therefore use reasonable force as necessary to present the person detained to medical personnel authorized to collect a blood specimen if the person does not voluntarily submit to a breath or blood test. In these cases, the officer should advise the medical person taking blood of the protection from civil liability provided for in the Transportation Article (TR § 16-205.1 (c), (3)).

#### **4-400.8 MECHANICAL DEFECTS**

In any crash where the investigating officer believes that the crash was caused by a defect on one or more of the involved vehicles, the investigator may request an inspection by vehicle inspectors of the Maryland Department of State Police. The request will be forwarded through the district / shift commander with a copy of the crash report. This action will be completed prior to the end of the next business day following the crash. These requests will normally be limited to those crashes which involve fatalities or are of a great magnitude or have some other significance. An example might be a vehicle currently being studied by the Department of Transportation because of an alleged manufacturing defect, e.g., 1980's GMC pickup fuel tank explosions.

#### **4-400.9 TRAFFIC OPERATIONS**

Traffic Operations Investigators have been trained to investigate crashes as they relate to the laws of physics, dynamics inside and outside the vehicle and human factors. Traffic Operations shall be summoned to the scene for the following crashes when on-duty and available:

- agency-vehicle involved crashes;
- school bus crashes; and





Administrative and Operational Manual

September 12, 2022

- crashes which occur on County roads which involve injuries or death.

Traffic Operations shall be summoned to the scene of the following crashes on a call-out basis when off duty:

- agency-vehicle involved crashes with injuries or death to any parties;
- fatal crashes;
- serious injury crashes as determined by Emergency Medical Services classification of a patient as Priority 1 or by a supervisor on scene; and
- in any circumstance when the Commander, Field Operations Section, based on the facts presented by the on-scene commander, deems such a response necessary.

In cases where Traffic Operations assumes responsibility of the investigation, the patrol supervisor and shift commander shall provide manpower assistance and other resources, as may be required by the investigator, in the investigation and handling of the scene.

#### 4-400.10 TRAIN-VEHICLE-PEDESTRIAN CRASHES

There are some special considerations for the initial officer on the scene and for the investigating officer when a train is involved in a reportable crash. When a train strikes a pedestrian and the pedestrian is fatally injured:

- if the train has stopped, it will be detained pending the arrival of a homicide investigator;
- the names of the train operator, engineer, conductor, brakeman and company will be obtained; and
- a crime / incident report will be completed.

If a train is involved in a collision with a vehicle and there are fatal or life-threatening injuries to train passengers or vehicle occupants:

- if the train has stopped, it will be detained pending the completion of the on-scene investigation;
- the names of the train operator, engineer, conductor, or brakeman as well as the name of the train company will be obtained;
- the names of any injured train passengers and their address will be obtained; and
- a crash report will be completed containing the vehicle and occupant information as well as all other required information appropriate to the crash.

If a train is involved in a crash with a vehicle and/or pedestrian and there is property damage only with no apparent injury to persons on or off the train:

- the names of the train operator, engineer, conductor, or brakeman and the name of the train company will be obtained;
- no information will be solicited from the passengers of the train;
- the train will be allowed to proceed to its destination if a representative of the train company will remain behind to furnish information necessary for the report; and



Administrative and Operational Manual

September 12, 2022

- a crash report will be completed containing the vehicle and occupant information as well as all other required information appropriate to the crash.

## 4-403 AIRCRAFT ACCIDENTS

### 4-403.1 MILITARY AIRCRAFT

Military aircraft accidents that occur in this jurisdiction will be investigated by the appropriate military command. The National Command Center, Washington Military District shall be notified and the appropriate military investigative command will respond.

They are also charged with the responsibility of guarding the wreckage, determination of the cause, care and treatment of injured military personnel, identification of the injured and deceased, notification of next of kin, and publicity releases.

An Offense / Incident Report will be prepared for this Agency by the assigned investigating officer, to include Death Report, if death occurs. The following steps shall be taken immediately by the initial officers on the scene:

- Have Communications notify the National Command Center, Washington Military District;
- Obtain whatever assistance is required:
  - Medical
  - Fire and Rescue
  - Additional Agency personnel
  - Alert area hospital(s)
  - Medical Examiner - if death occurs
- Secure the area and exercise extreme caution. Military aircraft may contain classified documents and/or equipment, live ammunition, high explosives and nuclear weapons, plus high octane aviation fuel. The immediate danger of further fire and/or explosion after the crash must be considered;
- Remove injured persons to a safe distance away from the wreckage;
- Render first aid as required;
- Protect the wreckage, isolate and guard the area, exclude unauthorized persons;
- Prevent spectators from picking up and taking away "souvenirs;"
- Control traffic and expedite admittance of authorized traffic;
- Make a courtesy notification to the NTSB / FAA.

Upon the arrival of proper military authorities, Agency personnel will accede to their requests and render necessary assistance.

### 4-403.2 NON-MILITARY AIRCRAFT ACCIDENTS



**Administrative and Operational Manual**

**September 12, 2022**

---

Aircraft accidents, other than military aircraft, will be reported immediately to the Maryland State Police who will coordinate their investigation with the NTSB / FAA.

The CCSO will assist by providing resources if needed as well as the completion of all death reports associated with the crash.

In the event CCSO officers are first on the scene, those officers will take great care in preserving the scene while assisting in the medical treatment of the wounded. Only in instances of crash survivors or an impending fire, will an officer disturb any part of the wreckage. Officers will secure the scene, keeping unauthorized and unnecessary personnel from disturbing any portion, to include the deceased.

Officers will record as much information as is available from the aircraft, to include the type of aircraft (helicopter, fixed wing, experimental or non-powered ultra-light), any numbers or markings, and the number of passengers. Witnesses should be identified and statements obtained concerning the accident. Officers will complete an Offense / Incident Report for Assisting Allied Agency, detailing their actions and information obtained.



Administrative and Operational Manual

September 12, 2022

---

## 4-500 PROPERTY AND EVIDENCE MANAGEMENT

The Property Management Section will have a system of control over property taken into custody by Agency personnel. The procedures outlined in this policy define the handling of property and evidence.

### 4-500.1 DEFINITIONS

**Recovered Property** - includes property that is abandoned, confiscated, seized, found, evidence or any property taken into custody by an officer or Forensic Science Technician. This section does not address vehicles seized as evidence, which is covered in AOM 4-217. This section does not address photographic evidence, which is addressed in AOM 3-221.

**Evidence** - Any tangible item created or recovered by Agency personnel to further the investigation of any case (i.e. shell casings, DNA, latent fingerprints, etc.), active or inactive, shall be considered evidence.

**Chain of Custody** - A record of all individuals who have maintained control and/or custody of evidence and property. At a minimum, the record shall include a mechanism for the Property Custodian to ascertain the current location of the property and who is responsible for the integrity and security of the property in question.

**Exceptional Circumstances** - Property recovered under unusual or unforeseen circumstances encountered by the officer.

**Secure Area** - An area designated by the Commander of Property Management with limited authorized access that can provide integrity and security for recovered property. Agency secure areas are available at the Annex, all district stations (evidence drop lockers or evidence drop boxes), the Digital Forensics Unit and the Forensic Science Section.

### 4-500.2 GENERAL PROPERTY PROCEDURES

Agency personnel shall account for all property taken into custody during the course of their duties and will make a reasonable effort to identify the owner. Property will be protected from contamination, alteration, destruction and damage.

Unless there is an exceptional circumstance or the property is released by the officer, all property obtained as a result of official duties shall be placed under the control of Property Management prior to the end of the officer's shift. Property will be considered under the control of Property Management when property is entered into the Property Management System and placed in an authorized secure area. No property will be stored in an officer's vehicle, locker, file cabinet, case file, desk, etc.

Property taken into custody shall be separated into three categories:

- Evidence
- Safekeeping/Releasable
- Destroy

Officers taking property/evidence into their custody shall document the recovery in their police report and affix a property evidence label to the packaged property, prior to it being placed in any property storage area. A property label must have identifying information on it and shall be affixed in such a manner to avoid damaging the property.

To ensure a proper chain of custody record, prior to any property being placed into storage, the officer shall ensure the property is logged in the Property Management System (PMS).



**Administrative and Operational Manual**

**September 12, 2022**

All property obtained by Agency personnel must be documented in a police report except when the property is released without a police report. In those cases, the releasing employee must document the recovery and release the property using the property release form #292.

Property with identifying numbers will be checked through METERS / NCIC. The results of the NCIC/METERS response should be noted in the officer's report under the property section.

In cases of seized monies, unless exigent circumstances prevent it, a receipt shall be issued using the Agency-issued receipt book. When used, the original copy shall be issued to the citizen, the officer shall retain a copy, and the third copy shall be placed as an attachment to the main case file. When seized during service of a search warrant, the search warrant return will serve as a receipt.

In the case of recovered evidence, upon approval by the State's Attorney or a designee, property may be photographed, processed, and released to the owner. The photographs shall be submitted to the Digital Imaging Management System (DIMS). Copies of the photographs of property may be attached to the case file. This procedure shall exclude firearms, which must be processed through the Firearms Tracking Specialist to determine if the owner / requestor is eligible to possess a firearm.

### **4-500.3 KNOWN PROPERTY OWNERS – NOTIFICATION AND RELEASE**

When non-evidentiary property is recovered and the property owner is known, the recovering officer shall attempt to notify the owner. If feasible, the recovering officer should release the property to the owner or the owner's designee. Other than releasing property to sworn members of the Agency, whenever property is released, the releasing employee shall document the release with a signed receipt. If the case has been issued an IR number, the receipt will be submitted to Records. If an IR number has not and will not be issued, the officer shall turn the receipt into Property Management. If the officer is not able to release the property in a timely manner, the officer shall submit the property to Property Held and instruct the property owner to contact the Property Custodian.

### **4-500.4 FOUND PROPERTY – NOTIFICATION AND RELEASE TO FINDERS**

When a citizen finds property, other than contraband or evidence, and turns it in to an Agency employee, and ownership cannot be immediately established, the employee receiving the property shall advise the finder if the owner is not found or does not come forward within six (6) months the finder may claim the property by contacting Property Management.

The officer shall ensure the name of the finder is listed accurately in the "finder" section of the Property Management System. If the finder requests a receipt, the officer shall issue a receipt.

Found currency will be handled and processed in accordance with all established property policy.

Found firearms will also be handled and processed in accordance with all established property policy. The receiving employee will notify the finder to contact the Firearms Tracking Specialist for information about its release. Finders will be required to appear before a Firearms Hearing Board and will be required to meet all federal and state requirements for acquisition of a firearm.

### **4-501 PROPERTY HELD CUSTODIAN**

Each workday the Property Held Custodian will ensure the pick-up of property from all secure areas and should make an effort to pick up any property at the Forensic Science Section. Property will be checked and any discrepancy found by a property custodian will, whenever possible, be immediately corrected by the submitting



**Administrative and Operational Manual**

**September 12, 2022**

officer. Property will not be accepted or placed in Property Management storage by a property custodian until necessary corrections are made.

The Property Held Custodian shall assign a shelf and bin number to each item of property and place it in a designated Property Management storage area. The assigned shelf and bin number or secure location shall be recorded in the Property Management System.

Items not considered evidence or of value to an investigation will be stored in Property Held for six (6) months and will then be disposed of according to law.

Items being held as evidence will remain in Property Held until notification to the contrary is provided through policy, or the courts or through the use of an MOU with the State's Attorney's Office. DNA evidence must be held until the sentencing of an accused is completed or the investigation has been adjudicated and the sample has proven to hold no evidentiary value. The Property Custodian shall use good judgment, common sense and practice diligence when disposing of evidentiary items.

## **4-502        SECURE STORAGE AREAS**

The secure property storage rooms at the District Stations contain:

- A CDS drop;
- a currency / valuables vault at District I; and
- various sized lockers for storage of property.

All recovered property shall be placed in a secure locker or storage location. All district stations are set up to receive property items which are non-breakable and will fit through the mailbox type drop chute. Other property such as breakable items; items under pressure; i.e., aerosol spray cans, or items which are too large or of such weight that they may damage other items in the property chute, can be secured in the property lockers also located in the property storage room. Property shall not be left unsecured in any area, including on the property storage room floor of the property room.

Recovered drugs are to be placed in the slot of CDS drop chute. A Property Management employee is responsible for picking up drugs from these locations and transporting them to Property Held at the Annex.

Officers are to use the smallest storage area which will accommodate the property being stored.

### **4-502.1      EVIDENCE LOCKERS**

Evidence lockers are under the complete control of Property Management. Recovered property/evidence excluding large sums of currency, will be placed in these lockers and only a designee from Property Management will have access to the property.

Each storage locker has an unlocked and numbered key lock that corresponds with the locker number. After placing property into the locker, the officer will lock the padlock and confirm it is secure. Officers will record which locker was used by recording the locker number on the property log. Under no circumstances shall an officer place a personally owned lock on a locker.

The property collected from these lockers will be transferred to Property Management and processed as usual.



**Administrative and Operational Manual**

**September 12, 2022**

## **4-502.2 FORENSIC SCIENCE SECTION PROPERTY STORAGE**

Due to the unique duties of the Forensic Science Section, long-term storage containers have been established to maintain biological / hazardous evidence at the FSS facility. These containers are utilized to refrigerate and maintain evidence for long periods until adjudication of a case. These containers are the responsibility of the Special Services Commander/Property Custodian; however, they are under direct control of the Deputy Director of FSS. All property procedures outlined in this section apply and all rules of evidence will be followed. The storage containers will remain locked at all times, with the exception of evidence retrieval.

## **4-502.3 EXCEPTIONAL CIRCUMSTANCES**

If an officer encounters an exceptional circumstance, the officer will immediately contact their supervisor. With authorization of a division commander, the officer shall place the property into an alternative secure area and log the property into the Property Management System by the end of his shift. The location of the property should be entered as "other" in the Property Management System and the details of the secure location and the exceptional circumstance should be documented in the Note function in the system.

The officer will be responsible to enter or notify the Property Custodian of the final disposition of the property within 72 hours. If circumstances dictate a delay in the final disposition of the property, the officer must receive approval from a division commander.

The details of the exceptional circumstance, including the safeguards undertaken to ensure the integrity and security of the seized property and authorization of a division commander, shall be documented in the officer's report.

The authorization of property stored under exceptional circumstances should be extremely rare.

## **4-503 SEIZED PROPERTY**

### **4-503.1 SEIZURE OF REGISTRATION PLATES AND DRIVERS' LICENSES (MVA)**

All registration plates and driver's licenses not of evidentiary value shall be deposited into the MVA drop box located at each district station. Officers depositing items into the drop box shall complete the log that details the circumstances of the recovery.

### **4-503.2 SEIZURE OF CURRENCY**

Whenever currency is taken into the custody of the Agency, it will be handled in accordance with the following procedures:

- If the owner is known, the officer making the seizure shall promptly issue a receipt to the person from whom the currency was recovered;
- all currency will be counted and the amount certified by two Agency personnel, one of whom is a supervisory or management level employee;
- the preprinted Currency Envelope Form #365 shall be used in connection with all monies taken into custody by this Agency;
- the currency envelope containing the currency and a copy of the receipt will be sealed and placed in the



Administrative and Operational Manual

September 12, 2022

currency vault at the District I Station; and

- the officer will complete the property section in his police report.

If the recovered currency is evidence, the officer's report shall indicate the currency is evidence, and it should be retained by Property Management.

### 4-503.3 CURRENCY SEIZED DURING DRUG AND/OR VICE INVESTIGATIONS

In addition to the above policies, whenever currency is seized pursuant to drug or vice investigations, the reporting officer shall comply with all of the following procedures:

- All currency shall be photographed as a whole. The photographs shall be marked and sent to Property Management; and
- The Transmittal Form #130 shall be completed and placed in the currency envelope along with the receipt and currency prior to sealing.
- If the incident involves the seizure of funds from a gambling investigation, the investigating officer shall ensure form #859 is completed and the owner signs the form. If the owner is unable to sign or refuses to sign form #859, the officer shall mail the form certified mail to the last known address of the owner. The officer shall document the notification in their incident report.

### 4-503.4 RECOVERED CURRENCY WITH UNKNOWN OWNER

When an officer recovers currency and the owner cannot be identified, the officer shall submit the currency to Property Management. The currency need not be placed in a currency envelope and form #130 need not be completed. The recovered currency shall be maintained as any other recovered property.

### 4-503.5 COLLECTION AND DISPOSITION OF CURRENCY

The Commander, Property Management Section will arrange for the collection of all currency from the currency vault. When collected, two employees shall count and verify the currency in the envelope agrees with the recorded information. In addition, the Commander shall be responsible for having the currency:

- transported and delivered to the County Treasurer;
- returned to the owner; or
- otherwise disposed of or retained as may be appropriate.

### 4-503.6 STORAGE OF HIGH RISK ITEMS

High risk items are identified as:

- cash over \$15,000
- firearms
- controlled dangerous substances
- explosives





Administrative and Operational Manual

September 12, 2022

- any item the property custodian deems to have significant value or worth.

High risk items shall be stored separately from regular property. The Commander of Property Management shall ensure extra security measures are taken when storing these items.

#### 4-503.7 SEIZED WEAPONS (OTHER THAN FIREARMS)

When a weapon (other than firearms) is seized by a member of this Agency and the individual who had possession of the weapon is not criminally charged, the disposition of the weapon will be completed in the same manner as all other routine property.

#### 4-503.8 SEIZURE OF FIREARMS

When a firearm is seized, the following procedures will be observed:

All recovered firearms **must be made safe, packaged in a box**, and placed in a property locker at any of the district stations. If a box is not available, it is permissible to package the firearm in a paper bag. Plastic packaging materials shall not be used. All firearms shall be deposited with Property Held. If an officer believes a recovered firearm requires immediate processing, the officer must contact the FSS and arrange for FSS personnel to facilitate the processing. Once the processing is complete, FSS personnel will be responsible to deposit the firearm at Property Held. This procedure will ensure all firearms meeting the criteria outlined below will be fingerprinted, swabbed for DNA, and test fired for entry into the NIBIN system.

#### 4-503.9 SEIZED FIREARMS NOT INVOLVING CRIMINAL CHARGES

Officers seizing firearms not involving criminal charges (ex parte, other court order, etc.) will follow all established property procedures. In addition, at the time of seizure the officer will notify the owner to contact the Firearms Tracking Specialist within six months to apply for the release of the weapon(s).

#### 4-503.10 FIREARMS RELEASE PROCEDURES AND ELIGIBILITY

The Firearms Tracking Specialist shall conduct a background check and criminal history review to determine ownership and eligibility to retrieve and possess a firearm. If an owner refuses to cooperate with the hearing process, the Firearms Tracking Specialist should contact the Commander of Property Management or The Office of General Counsel for advice.

If the seized firearm has not been reported stolen prior to its seizure, the owner attempting recovery must apply to the Firearms Tracking Specialist within six months of notification by the seizing officer. A Hearing Board may have the firearm returned to the owner following an appropriate inquiry.

#### 4-503.11 FORFEITURE OF HANDGUNS

Definitions, for Agency purposes, are:

Firearm:

- A weapon that expels, is designed to expel, or may readily be converted to expel a projectile by the action of an explosive; or



Administrative and Operational Manual

September 12, 2022

- The frame or receiver of such a weapon.

Handgun:

- A firearm with a barrel less than 16 inches in length;
- A pistol, revolver, or other firearm capable of being concealed on the person;
- A signal, starter, and blank pistol;
- A short-barreled shotgun; or
- A short-barreled rifle,
- A magazine when it is recovered with a specific handgun.

Short-Barreled Rifle:

- A rifle that has one or more barrels less than 16 inches long; or
- A weapon that has an overall length of less than 26 inches long and was made from a rifle, whether by alteration, modification, or otherwise.

Short-Barreled Shotgun:

- A shotgun that has one or more barrels less than 18 inches long; or
- A weapon that has an overall length of less than 26 inches long and was made from a shotgun, whether by alteration, modification, or otherwise.

The provisions of this subsection apply to seized handguns that were:

- Worn, carried, or transported in violation of §4-203 (“Wearing, carrying, or transporting handgun”) or §4-204 (“Use of firearm in commission of crime”) of the Criminal Law Article of the Maryland Code; or
- Sold, rented, transferred, or possessed in violation of title 5, Subtitle 100 of the Public Safety Article of the Maryland Code (“Regulated Firearms”).

Once all of the procedures relating to seized firearms as described above have been completed, the Firearms Tracing Specialist will make a determination as to whether a seized handgun should be forfeited. The Firearms Tracing Specialist will send notice of the forfeiture to the owner of the handgun, if known. If the owner of the handgun is not known or is not located, the handgun is forfeited and disposed of in accordance with Md. Code Ann., Criminal Procedure §13-206 and this subsection.

Upon notification of the forfeiture determination, the owner of the handgun has 30 days to petition the District Court of Maryland sitting in Charles County for release of the handgun. The Firearms Tracing Specialist shall notify the State’s Attorney’s office of any court proceedings relating to the handgun immediately.

If the owner of the handgun does not make a timely request in the District Court, or if the court rules that the handgun is to be forfeited, the handgun may be disposed of in accordance with Md. Code Ann., Criminal Proceedings §13-206 and this subsection.

Once the handgun has been forfeited, the Firearms Tracing Specialist shall recommend that:

- The handgun be retained for official use of the Charles County Sheriff’s Office;
- The handgun be destroyed; or
- The handgun be sold, exchanged, or transferred to another law enforcement unit for official use by that unit.

Upon disposition of the forfeited handgun, the Firearms Tracing Specialist shall send to the Secretary of State



Administrative and Operational Manual

September 12, 2022

Police a memorandum stating:

- A description of the property forfeited;
- The type of disposition made; and
- The identity of the person to whom the property was transferred for disposal, retention, or official use.

#### **4-504 HANDLING OF FIREARMS SUBMITTED TO PROPERTY MANAGEMENT OR FORENSIC SCIENCE SECTION**

The following procedures shall be followed when a firearm is submitted to Property Management or the Forensic Science Section (FSS). All firearms submitted will be processed in accordance with this policy.

Each firearm shall be handled in such manner as to prevent damage and to prevent injury to the handler or others. No foreign object(s) shall be placed in the barrel, cylinder, breach, ejection port, magazine well or magazine of any firearm. No firearm will have the cylinder, slide or bolt taped open and no firearm shall be dismantled in any fashion.

All firearms shall be cleared of ammunition and the ammunition will be packaged separately before being submitted for storage. If an employee encountering a firearm is unfamiliar with how to unload it, assistance will be requested to aid with the unloading. In the event of an unusual firearm type, which cannot be verified as unloaded, the weapon will be handled as if it were loaded.

During normal business hours, a loaded weapon will not be packaged and will be transported directly to the FSS. After hours, firearms will be secured in an evidence storage locker at a district station or a locker at FSS with all appropriate reports and evidence labels. A warning notice will be placed on the front door of the locker indicating a loaded firearm is inside. The submitting officer will then notify Property Management regarding the loaded firearm's condition and storage location.

Property Management will be responsible for picking up the firearm and transporting it to Property Held or FSS. All appropriate reports and evidence chain of possession labels will be completed for each firearm submitted. Labels shall not be attached directly to any firearm. No markings shall be made on any firearm. The property will be documented in the report along with a complete description of each recovered firearm, to include make, model, caliber, serial number and date and time of recovery. The condition of each firearm shall be noted in the report. This note shall particularly describe any visible damage to the firearm.

If the seizure of a firearm is court ordered, a copy of the court order shall be submitted with the report.

If a large number of firearms are seized and storage in a district station storage locker is not feasible, arrangements to store them at the Property Management Annex or FSS can be made by notification to the FSS Deputy Director or one of the following persons:

- Firearms Tracking Specialist;
- Property Custodian;
- Commander, Property Management Section; or
- Commander, Special Services Division.

#### **4-504.1 FIREARMS ANALYSIS**

Cases involving some type of ballistic examination of a firearm, i.e. firearm comparison to shell casings, etc., or projectiles, will require the completion of a Multi-Purpose Request/Request for Laboratory Examination Form #115.



Administrative and Operational Manual

September 12, 2022

The below articulated process is a standard procedure applied to firearms meeting the requirements. A request form is not necessary in these cases.

The Forensic Science Section will process firearms for latent fingerprints, touch-DNA, firearms operability, and will test fire approved weapons for NIBIN entry when firearms are in the possession of, or recovered from, a suspect in a criminal incident; involved in a criminal incident including suicide; stolen/recovered; or requested by the investigator.

**NIBIN:** A database which stores and cross references specific markings made on shell casings when a weapon is fired. FSS will determine if the firearm meets eligibility requirements and enter the firearm or casings into NIBIN.

**Test Shot Program:** The Charles County Forensic Science Section has established a Test Shot Program. In accordance with this program, the FSS will not test fire any firearm requiring an examination beyond functionality and the entry of test fires into NIBIN.

All handguns, rifles and shotguns collected as a result of any crime, forfeiture or abandonment will be test fired by the Forensic Science Section. Two casings and two projectiles will be sent to Property Held for storage. Any firearm recovered that also meets NIBIN entry eligibility requirement will also have a casing entered into the NIBIN database.

A test fire certificate will be completed by the FSS. The original will be retained by the FSS and a copy will be sent to the main case file.

#### 4-504.2 NATIONAL INTEGRATED BALLISTIC INFORMATION NETWORK (NIBIN) PROGRAM

The Charles County Sheriff's Office (CCSO) has partnered with the Bureau of Alcohol, Tobacco, Firearms and Explosives (ATF) to participate in the National Integrated Ballistic Information Network (NIBIN) system. This is an agreement between the CCSO and the ATF to take digital images of the fired cartridge cases from a crime scene or test fired cartridge cases from seized firearms. The cartridges are then uploaded utilizing the IBIS BRASSTRAX Acquisition Station. This partnership is designed to further local law enforcement efforts in crimes involving firearms, and provide ballistic data for comparison among agencies around the country.

The NIBIN program will operate out of the CCSO Forensic Science Section, and will be supervised by the Deputy Director of the Section. Cartridge cases from a crime scene will be collected and submitted as property in accordance with current CCSO General Orders and evidence packaging guidelines.

#### 4-505 INSPECTION AND RELEASE OF PROPERTY

Absent exigent circumstances, whenever property is needed for court purposes, review, investigation, etc., officers should provide advance notification to the Property Custodian.

##### 4-505.1 REVIEW AND INSPECTION OF PHYSICAL EVIDENCE

A criminal defendant is entitled to inspect, copy, and photograph all tangible evidence (including photographs and recordings) that the State's Attorney's Office intends to use at trial. The obligations of the Charles County State's Attorney's Office extends to all evidence in the possession or control of the Charles County Sheriff's Office.

For cases either under active investigation or prosecution, any requests made by a defendant or defense attorney



Administrative and Operational Manual

September 12, 2022

to review and inspect evidence or other property in the possession or control of the Charles County Sheriff's Office must be made through the State's Attorney's Office. The prosecutor assigned to the investigation or prosecution will contact the lead investigator to arrange the review and inspection. A prosecutor must be present during the review and inspection unless the assigned prosecutor explicitly waives a prosecutor's presence. An investigator other than the lead investigator may conduct the review and inspection with the consent of the assigned prosecutor. At the conclusion of the review and inspection, the investigator will submit a supplemental report describing property shown to the defense and property the defense declined to inspect.

Any disputes, disagreements, or other issues that arise during a review and inspection should be handled by the prosecutor who is present. If a prosecutor is not present, the assigned prosecutor must be notified of the issue as soon as possible. Any unresolved dispute between investigators and prosecutors must be reported to the investigator's supervisor and the Office of General Counsel.

Requests to review and inspect tangible evidence other than by a defendant or defense counsel regarding a pending investigation or prosecution will be resolved as required under the Maryland Public Information Act by Records Management in consultation with the Office of General Counsel.

#### **4-505.2 REVIEW AND INSPECTION OF SEXUALLY EXPLICIT OR CONTRABAND EVIDENCE**

This subsection controls the review and inspection of sexually explicit material, including evidence of revenge porn, sextortion, and child pornography.

Sexually explicit material will not be copied and disseminated except as part of an investigation, trial or other court hearing.

*Review and Inspection as part of criminal prosecution.*

Any requests to review or inspect sexually explicit material in the possession or control of the Charles County Sheriff's Office must be made through the State's Attorney's Office.

*Review of sexually explicit material will occur at the Criminal Investigation Division. The review will occur in the presence of an investigator and a prosecutor. A criminal defendant may review the material in the presence of defense counsel. No person will be permitted to make a copy of any sexually explicit material either digitally, photographically, or otherwise. If defense counsel requests the opportunity to review the material privately with the defendant or a member of the defense team (other attorney, paralegal, or investigator), such review will be permitted only upon surrender of cellphones, digital tablets, cameras, removable storage devices, and any other device that could be used to copy the material. Video monitoring may be undertaken to ensure the integrity of the evidence, but no audio monitoring may occur.*

*Inspection of sexually explicit material by a defense expert will occur at the Criminal Investigation Division. The Digital Forensics Unit will, upon request, provide the defense expert with a computer containing a mirror drive of the material and the software used by the Digital Forensics Unit to analyze the material. If the defense expert is unable to complete his or her analysis during a single session, the computer will be sealed and kept secure in between sessions. No member of the Digital Forensics Unit or any other CCSO employee will view or access the computer until the expert's review is complete or unless requested by the defense expert. When the defense examination is complete, the computer will be wiped of all data and software. No member of the defense team will be permitted to copy any sexually explicit material.*

*Disputes regarding the review or inspection of sexually implicit material should be resolved by the prosecutor assigned to the investigation or prosecution.*



Administrative and Operational Manual

September 12, 2022

*Court orders.* If a court issues an order for review or inspection contrary to the procedures outlined in the AOM, the investigator must obtain a copy of the order from the assigned prosecutor. The order must be forwarded to the Office of General Counsel.

### **4-505.3 TRANSFER OF PROPERTY FOR COURT OR INVESTIGATIVE PURPOSES**

Whenever any property is obtained from Property Held for court purposes, it shall be picked up and returned daily until no longer needed for court purposes. If the court retains the property, the court shall be responsible to maintain proper chain of custody documentation for the property. At the conclusion of the court proceedings, the property shall be returned to Property Held.

Due to the nature of an investigation, property may be transferred to an officer for an extended period of time. This transfer for investigative purposes and return must be approved by the officer's section commander and will be documented in the Property Management System.

### **4-505.4 RELEASE OF PROPERTY FOR TRAINING PURPOSES**

Certain items of seized or forfeited controlled substances or weapons may, with the written approval of the Sheriff, be retained for investigative or training purposes.

All controlled substances or weapons approved for training or investigative purposes are to be marked for investigative or training use and securely stored by Property Held until released. These items are only to be released to a supervisor or commander.

All items of controlled substances utilized for training by the Sheriff's Office Canine Unit, are signed out / issued to the Canine Unit Supervisor from Property Held. These substances are to be taken from items identified for destruction. While in his possession, the Canine Supervisor will ensure the substances are stored in a secure area.

The Canine Unit Supervisor shall document the use and any depletion of these substances in the Unit's training records. Depletion of the substances may occur with their use and re-use during training exercises. Once substances become impotent or depleted, they shall be returned to Property Held and new samples may be requested.

Any firearm approved to be used for training purposes shall be selected from those firearms identified for destruction.

Each designated firearm shall be, where required, registered with the Bureau of Alcohol, Tobacco and Firearms (BATF) as being placed into lawful service of the Charles County Sheriff's Office. Those firearms that do not require registration with BATF, will only be authorized for Agency use by the written authority of the Sheriff. Through this process, all firearms used for training purposes are in the legal lawful service of the Sheriff's Office, thus eliminating the need to use firearms from open or active cases.

Details regarding explosive materials used for training purposes are covered in SOP manuals maintained by those units which utilize them.

### **4-506 PROPERTY DISPOSITION**

Agency employees will not convert to their own use or have any claim to any evidence or recovered property. Persons authorized to receive property eligible for release are the identified owner or an authorized representative



Administrative and Operational Manual

September 12, 2022

of the identified owner.

Property which is not held for court or other law enforcement purposes will be retained by Property Management for six months (except seized firearms). If not claimed within that time, the property will be determined to be abandoned and will be disposed of as prescribed by law.

Property may be released only between the hours of 0700 and 1500, Monday through Friday. However, in an emergency or extremely unusual instance when the property must be released at some other time, the Property Custodian or other persons designated may be contacted to make arrangements.

Arranging for the disposition of property and evidence is the responsibility of the Property Custodian in conjunction with the seizing officer. Property and evidence shall be released or disposed of as soon as legally possible or feasible. Unless acting under a written MOU, no property shall be released or destroyed without the Property Custodian notifying the seizing officer and approval from State's Attorney's Office.

Ordinarily the viewing of evidence or suspected stolen property shall be accomplished only during normal business hours, unless arrangements have been made in advance with the investigating officer and the Property Custodian.

In all cases, the final disposition of all property should be accomplished within six (6) months after all legal requirements have been met. Property will not be released if it is:

- contraband;
- a confiscated motor vehicle;
- money confiscated as a result of CDS / vice violations; or
- being held as evidence.

#### **4-506.1 DECEASED PERSONS - RELEASE OF PROPERTY TO NEXT OF KIN**

The disposition of a deceased person's property is subject to the Estates and Trust Laws of Maryland. However, unless being held as evidence, or for some other investigative purpose, the personal effects of a deceased person may be released to a competent member of the immediate family (spouse, children, parents, etc.) who was living with the deceased at the time of death. If there is any question whatsoever as to ownership or questions regarding relationships, the personal effects must be forwarded to Property Management for later disposition. In these cases, the requestor shall be directed to the Office of the Register of Wills.

#### **4-506.2 DECEASED PERSONS - NO RELATIVES TO ACCEPT PERSONAL EFFECTS**

When no immediate family member can be located, the personal effects found on the deceased shall be taken into custody and submitted to Property Management. If the property is not claimed within a period of six months, it will be disposed of according to law.

#### **4-506.3 PROTECTION OF DECEDENTS' PROPERTY**

On occasion, members of the Charles County Sheriff's Office are called upon to respond to the scene of deceased persons. If relatives are on the scene or available to respond within a reasonable amount of time, there is no need to sequester the property. In those cases where no next of kin is readily available or when no next of kin can be located, this provides protection of the decedent's property or premises.

The Commander, Judicial Services Section and/or a designee is responsible to arrange for a member of Judicial Services to respond to the scene and secure the premises to the best of the employee's ability. Sworn members of Judicial Services Section will be responsible for call-outs 24 hours a day, 7 days a week in order to fulfill this



**Administrative and Operational Manual**

**September 12, 2022**

obligation. The employee shall post the premises by affixing a copy of the "Order For Protection of Decedents' Property" in a conspicuous location. Judicial Services will maintain a supply of "Order for Protection of Decedents' Property" notices at Judicial Services.

When a request for an "Order for the Protection of Decedents' Property" is received by Communications from an officer, the Commander, Judicial Services and/or a designee shall be contacted. Arrangements will be made for an officer from Judicial Services Section to respond. A Judicial Services officer will first call for available information, then respond to execute the sequester. The residence will need to be safeguarded until arrival of the Judicial Services officer so the proper sequester may take place.

The following information must be available from the original officer on the scene:

- the complete name, address and type of property to be sequestered (home, apartment, vehicle, etc.);
- the specific reason for the sequester (next-of-kin unknown, unavailable, etc.);
- the name and identification number of the requesting officer and the time the request for sequester was made; and
- a list of materials the on-scene officer feels are necessary to safeguard the property (locks and hasp, plywood sheathing or doors, and/or windows, etc.).

The on-scene officer shall notify Animal Control to remove any animals from the premises.

There is no need to call out a Judicial Services officer if the property to be sequestered can be maintained until the normal working hours of the Civil Section.

Orders for Protection of Decedents' Property issued by the Register of Wills during normal business hours will be handled by the Civil Section within Judicial Services. Once issued, the order will be given to Court Security for immediate transport or pick-up by the Civil Section.

#### **4-506.4 JUDICIAL SERVICES RESPONSIBILITY**

The Judicial Services officer responsible for executing a sequester order shall proceed to the address within two hours of the original notification. The officer shall take the following steps:

- obtain an "Order for the Protection of Decedents' Property" notice from Judicial Services and fill out all necessary information;
- place the original copy of the order in a water-resistant cover and firmly and conspicuously affix it to the property;
- obtain from Judicial Services the construction materials and/or tools necessary to safeguard the decedent's property;
- upon arrival at the scene, request that the officer(s) on the scene remain until the property is properly secured;
- record the name(s) and identification number(s) of the officers on the scene on the copies of the order;
- if needed, ensure Animal Control has removed any animals from the property;
- ascertain from the officer(s) on the scene if attempts were made to locate and contact the decedent's next-of-kin;





Administrative and Operational Manual

September 12, 2022

- 
- secure the residence with whatever materials are needed;
  - whenever possible, secure doors and windows with existing locks (no outside key access);
  - if possible, obtain keys to the front door of the premises, along with the keys to any locks that have been installed; and write the serial numbers of the keys on all copies of the order, noting which key fit which lock (this includes car keys). If necessary, change locks to non-master key and keep all sets of keys;
  - in situations where apartment rental offices may be contacted to prevent drilling into apartment doors to place a hasp and padlock, the Judicial Services officer should request the locks be changed to a non-master lock and require that all keys be turned over to the officer;
  - document on the return any unusual circumstances (i.e., severely damaged by weather, vandalism, unknown causes, etc.) and other appropriate information;
  - record appropriate information to include: the number of locks used, serial numbers of locks and keys, amount of cash seized (if any), name of apartment project and telephone number(s), etc;
  - if there is reason to believe a theft, burglary or destruction of property may occur, initiate a patrol check for the premises;
  - carefully inspect the premises for security prior to securing; and
  - once the sequester order is complete, turn in all keys and remaining copies of the order and ensure information is logged on the return to the Judicial Services Commander or the Civil Supervisor.

No later than the morning of the next business day, Judicial Services will notify the Register of Wills of the sequester, provide them the name and address of the decedent and deliver a copy of the order.

**NOTE:** The only property authorized to be removed from the sequestered premises will be large sums of cash. If located, it shall be handled as required in this Manual by the initial officer(s) on the scene, or as required pending an investigation.

#### 4-506.5 REPORT DISTRIBUTION

After normal business hours, officers will forward the completed sequester package to the Judicial Services Commander. Copies of the completed order will be distributed as follows:

- original copy posted on the property / premises;
- copy to Register of Wills; and
- copy to be maintained in the Judicial Services file.

#### 4-507 CONVERSION OF CONFISCATED FIREARMS TO POLICE USE

The Sheriff may convert firearms forfeited under the provisions of Criminal Procedure § 13-206 to official police use.

#### 4-508 PROPERTY INVENTORY AND AUDIT PROCEDURES

The following documented inspections, inventories and audits shall be completed within areas controlled by the



**Administrative and Operational Manual**

**September 12, 2022**

Property Management Section:

- inspection to determine adherence to procedures used for the control of property is conducted semi-annually by the Commander, Property Management Section or designee;
- an audit of property shall occur whenever the person responsible for the property and evidence control function is replaced, reassigned or transferred. Such audit should be conducted jointly by the newly designated property custodian and the Commander, Property Management or designee;
- an annual audit of all property held is conducted by a supervisor not routinely or directly connected with control of property; and
- unannounced inspections of property storage areas are conducted as directed by the Sheriff.

**4-509 PROPERTY CLEARANCE PROCEDURES FOR EMPLOYEES**

All employees who terminate employment with the Agency shall comply with all of the employment clearance procedures as outlined elsewhere in this Manual. The employee shall obtain an Employment Clearance Form #240, which must be completed and signed by each required division or section commander. If, during the clearance procedures the Commander of Property Management determines the employee has failed to account for certain property because it has not been submitted or returned to the Property Held Section, the commander shall determine the circumstances surrounding the discrepancy and determine how to proceed.-

**4-510 COLLECTION AND PRESERVATION OF EVIDENCE**

Evidence is any item, which possesses the capacity to prove the existence or non-existence of fact. The most important aspect of evidence collection and preservation is to protect the incident / crime scene. This is dependent on the first officer to arrive on the scene. The successful prosecution of a case can depend on how evidence is processed and collected.

The first officer on a scene, unless relieved by a detective or higher-ranking officer, is responsible for seeing to it a scene is protected and properly processed.

Dependent on the nature of the incident, the first officer on the scene may make use of additional officers, evidence tape, ropes, and barricades to preserve the integrity of the scene. However, only those personnel necessary to assist in protecting, processing and investigating the scene should be allowed access.

**4-511 LEGAL CONSIDERATIONS**

To satisfy legal concerns regarding physical evidence an officer must be able to:

- identify each piece of evidence in court, long after it was collected;
- describe the exact location where an item was found;
- show the chain of custody of each item from its collection until court presentation; and
- explain any changes in the evidence between the time it was collected and the time it is introduced in court.

**4-512 FORENSIC SCIENCE SECTION**



**Administrative and Operational Manual**

**September 12, 2022**

The Forensic Science Section is primarily a support unit for the Criminal Investigations Division. Forensic science technicians are available 24 hours a day for processing the scenes of major criminal events and providing support to other components of the Agency as directed by the Commander, Criminal Investigations Division.

Forensic science technicians shall adhere to all procedures for handling property / evidence as outlined elsewhere in this policy.

When a forensic science technician is not utilized to process a scene, officers will collect evidence in accordance with Agency policies.

#### **4-513 PATROL OFFICER RESPONSIBILITIES**

The highest ranking officer at a scene shall make a decision about the necessity for assistance from CID and/or the Forensic Science Section. Patrol officers are responsible for processing all incident / crime scenes not processed by a forensic science technician. This would include most traffic cases, vandalism, thefts, minor assaults and burglaries. If there is a question about whether a particular scene should be processed, the Forensic Science Section or CID should be contacted.

All officers are issued the necessary equipment to process most incident / crime scenes, to include a camera, a measuring tape, various size evidence bags, fingerprint kit, disposable gloves, and crime scene tape / rope.

The officer investigating an incident shall submit an Offense / Incident Report, other required forms, and all recovered evidence before the end of his shift as directed elsewhere in Agency policy.

#### **4-514 BASIC CRIME SCENE GUIDELINES**

Unless exigent circumstances exist, Agency personnel will follow the below general guidelines for processing a scene:

- Carefully approach the scene so as not to disturb potential evidence;
- Thoroughly survey the scene to determine its boundaries and secure the area;
- Photograph wide shots of the entire scene from several different angles;
- Locate, photograph and mark the location of possible physical evidence. If necessary take more detailed photographs of the scene and specific items;
- Prepare a rough sketch or diagram of the scene. Note the location of each piece of evidence and possible points of entry and exit of the scene on the sketch / diagram;
- Process the scene for latent fingerprints. Photograph the location of the prints and lift and preserve them on fingerprint cards;
- Make notes while processing the scene which will later be used to prepare an investigative report. The report will document the elements of the crime scene to include:
  - the investigative report number;
  - the date and time the officer arrived on the scene;
  - the location of the crime;
  - the names of victims, witnesses and suspects (if known);



Administrative and Operational Manual

September 12, 2022

- existing conditions (lighting, weather, etc.);
  - a listing and location of recovered evidence;
  - if photographs were taken;
  - if measurements were taken;
  - other police personnel at the scene.
- Once the scene has been thoroughly documented, evidence will be collected.

#### 4-515 EVIDENCE COLLECTION

Evidence collection will be performed in a logical manner and in accordance with Agency policies and methods taught at the Academy or techniques learned during specialized training. The process shall start with the collection of fragile, easily lost evidence or objects which need to be moved immediately for safety concerns, such as loaded weapons in an area not easily controlled by available police resources. An attempt will be made to collect as much physical evidence as possible, to include collecting materials from known sources (hair, fibers, fabrics, paint, glass, soil, etc.). The person responsible for processing the scene should continue to take photographs as each item is collected and of any new evidence discovered during the collection process.

Most items of evidence will be collected in Agency- provided evidence bags; however, other items such as paper containers, envelopes, packets, plastic or metal cans and glass vials may also be used. Containers must be clean and free from contamination.

Items shall be protected from cross contamination, (i.e., a suspect tool being placed in the same container as a portion of painted wood frame from the scene).

Each item will be immediately marked or labeled and put into a sealed evidence container. If marked, items should be marked in such a way so as not to damage or contaminate the evidence.

Moist or wet evidence (blood, other body fluids, plants, etc.) shall be collected in paper containers and, if appropriate, have a bio-hazard label applied. If there is the possibility of saturation through the paper container, the evidence may be placed in an unsealed plastic container. To prevent deterioration and contamination, items should be transported immediately to the Forensic Science Section for air drying or refrigeration.

Finger and palm prints are one of the most reliable ways to place an individual at an incident / crime scene. All non-movable items at a scene should be processed using the Agency-supplied fingerprint kit. Small transportable items may be collected and taken to the Forensic Science Section for processing. If possible, always obtain elimination prints from victims and possible suspects for comparison.

Each time a piece of evidence is turned over to other personnel, the chain of possession / custody shall be documented in the Property Management System.

4-516 through 4-516.6 THERMO SCIENTIFIC TRUNARC ANALYZER moved to 4-560 – 4-560.6

#### 4-520 REQUESTS FOR FORENSIC EXAMINATION

When an officer investigating an incident recovers evidence which requires processing or examination, that officer shall prepare a Multi-Purpose Request / Request for FSS Examination Form #115 for items to be examined. Evidence will be marked and packaged in a sealed container and delivered to the property custodian's control by the recovering officer prior to the end of the officer's shift. The request form will be forwarded to the Forensic Science FSS. If a forensic science technician is available, the investigating officer shall prepare a request form and turn the evidence over to FSS.



**Administrative and Operational Manual**

**September 12, 2022**

A forensic science technician, upon receipt of a Request for Crime Laboratory Examination, will retrieve the evidence. Upon completion of the examination or processing of the evidence, the technician shall return the evidence to the property custodian, who will record its return.

When the Forensic Science Section receives a Request for Crime Laboratory Examination of evidence which cannot be conducted by the Charles County Sheriff's Office Forensic Science Section, the Section Supervisor will assign the request to a technician. The forensic science technician will initiate a case file and determine which outside laboratory will be used for the examination unless previously specified in the original request. The forensic science technician assigned the case will be responsible for submitting the evidence to the designated laboratory. Evidence shall be packaged and submitted based on the established protocol of the laboratory examining the evidence. All necessary requests and documentation will be completed by the assigned technician.

Results of examinations may be initially accepted in verbal form; however, the assigned technician shall request a follow-up written report.

All latent fingerprint lifts developed at a crime scene shall be placed on a Latent Fingerprint Card Form #98A and placed in a latent envelope. Latent lifts shall be picked up and kept on file in the Forensic Science Section.

After an examination is conducted, the technician will complete a report documenting their results in Police Mobile. All original supporting case documentation, such as notes, will remain in the Forensic Science Section case folder. A copy of the documentation will be forwarded to the Main Case File.

Each person receiving custody of any evidence shall ensure the chain of custody is documented. The current documentation of the chain of custody is in digital format. However, there may be circumstances requiring the chain of custody to be handwritten.

A request for Crime Laboratory Examination Supplement Page (Form #97A) shall be used if needed.

## **4-521 PREPARING AND PACKAGING PROPERTY / EVIDENCE FOR SUBMISSION**

All items will be packaged in the appropriate type of container and tagged with a property label. The property label shall contain identifying information that describes the property.

In cases of evidentiary firearms, the position of rounds will be documented when applicable. Firearms will be unloaded and ammunition packaged separately.

Sharp blades or cutting edges shall be packaged in a box designed to store such items.

Packages which are improperly prepared or tagged will not be accepted by forensic science technicians.

The chain of custody for all physical evidence must be maintained.

### **4-521.1 FSS EVIDENCE SUBMISSION PROCEDURES**

All evidence items submitted to the Forensic Science Section (FSS) must be properly packaged according to the Administrative and Operational Manual (AOM) 4-515 Evidence Collection, and 4-521 Preparing and Packaging Property / Evidence for Submission. A Multi-Purpose Request / Request for FSS Examination Form #115, must accompany all evidence submitted to FSS for examination. Officers submitting items with improper paperwork or packaging during business hours will be instructed to correct the errors prior to transfer of custody. The officer and his immediate supervisor will be notified of any errors in packaging or paperwork for any items left after business hours. The officer is to ensure all errors are corrected.



**Administrative and Operational Manual**

**September 12, 2022**

Lockers and locks are provided in the evidence bay at FSS for the storage of evidence submitted to FSS for examination. The evidence will be placed in the locker, and the lock secured. Evidentiary items stored at FSS, shall be documented in the Property Management System. Evidence items that are too large for the lockers may be temporarily stored in the secure bay area at FSS.

Moist or wet evidence items are to be packaged in accordance with AOM 4-515. When submitted to the FSS after hours, these items are to be hung in the drying chamber. Prior to leaving, ensure that any paperwork is secured to the outside of the chamber and the chamber is secured and plugged in.

The above policy is summarized in the checklist below, which will be posted at FSS:

**Short Term Storage Procedures**

**Dry Evidence**

- Ensure all items are packaged in accordance with the AOM.
- Ensure all paperwork is complete.
- Place property in locker or secure storage bay.
- Attach paperwork to locker door.
- Secure lock.
- Set alarm.
- Leave.

**Wet or Bloody Evidence**

- Hang items in the drying chamber.
- Secure the drying chamber.
- Secure completed paperwork to the door of the drying chamber.
- Plug the drying chamber in.
- Set alarm.
- Leave.

**4-522 DRUG AND NARCOTICS EVIDENCE**

When necessary, drugs and narcotics seized as evidence are to be sent to the Maryland State Police (MSP) Laboratory for analysis. Any officer submitting drug evidence to be processed for DNA and/or latent fingerprints by the Charles County Forensic Science Section shall remove the drugs / narcotics from its original packaging, repackage it, and send only the original packaging to FSS. Officers shall photograph the evidence first in its original packaging and then re-photograph it in its new packaging before submitting the evidence to the CCSO drug vault. This process will speed up the DNA and latent fingerprint results.

If the drug evidence is not going to be examined for DNA or latent fingerprints, and is only going to MSP for examination, it does not need to be repackaged.

**4-523 PREPARATION OF NARCOTICS TO BE SENT TO MARYLAND STATE POLICE LABORATORY**



**Administrative and Operational Manual**

**September 12, 2022**

Narcotics submitted for analysis to the Maryland State Police Lab (checked and submitted by the sworn property custodian) must meet the guidelines established by the Maryland State Police.

The sworn Property Custodian shall consult with the Maryland State Police Lab and remain current on submission requirements. If the originally submitted evidence packaging/quantity does not meet the Maryland State Police Lab submission guidelines, the submitting officer shall be responsible for the appropriate packaging and for the submission to the Maryland State Police.

Exhibits must be packaged individually and appropriately identified. Items such as pills, tablets and capsules should be accurately counted, but need not be weighed. Items involving traces or residue of suspected CDS need only be accounted for in number, not weight. Syringes to be submitted must be approved by the sworn property custodian.

Any items involving wet vegetable matter, such as large amounts of marijuana, must first be dried prior to submission to the MSP Lab. Fresh marijuana decays easily if it is not dried and can develop a toxic fungus. Submissions involving vegetable matter that is not dried may also result in losses of weight as the material dries. Vegetable matter shall be packaged in paper bags or other appropriate containers.

Evidence involving large quantities of material must be randomly sampled. For pills, tablets and capsules of a quantity greater than fifty (50), a 10% random sample should be submitted. Quantities of fifty (50) or less may be submitted in their entirety.

Exhibits involving whole plants of a length greater than one foot should be submitted by taking parts of the plant and submitting them. Parts to be included are the leaves, flowering tops, stems and seeds. Mature stalks and roots need not be included. Seizures dealing with a large number of plants should follow the 10% random sampling guideline.

Bulk exhibits of manicured vegetable matter and powders of quantities greater than one kilogram should be randomly sampled by taking ten samples from various locations within the exhibit. The weight of those ten (10) exhibits should not exceed ten (10) grams in net weight. Samples will be submitted in glass vials of approximately twenty (20) milliliters volume with screw-on caps.

Seizures involving the submission of liquids (volatile, toxic, or otherwise) must be securely sealed to prevent spillage and/or leakage of fumes. Any CDS in liquid form or PCP contaminated items will be double-bagged using lock-seal envelopes (heat seal / Kapak bags). Many chemicals, such as ether, benzene, etc., are highly flammable and toxic. If these chemicals are not essential to proving intent or do not establish a probative value, do not submit them to the MSP Lab. Ascertain their value from the State's Attorney and if not necessary for the successful prosecution of the case, then they should be disposed of in an appropriate and safe manner. When in doubt as to the proper packaging of chemicals, contact the sworn property custodian, Narcotics / Vice Section member or MSP Drug Unit for assistance.

A lock-seal envelope will be completed, all evidence to be analyzed placed therein, and the required forms attached to the outside of the envelope.

When only a sample of an exhibit is to be sent to the MSP Laboratory, the remaining portion will be placed in a separate sealed envelope, with a copy of the property record attached, and submitted to Property Held.

Narcotic-related property must be listed on a separate property record. If other property is involved in the same case, two property records must be completed.

Evidence shall be submitted to the MSP Lab as soon as possible after a seizure. Delays in submission may lead to the evidence not being ready when a case comes to court. Requests for "Rush" cases will not be given priority where lengthy delays in submission are involved.



Administrative and Operational Manual

September 12, 2022

#### 4-523.1 INSTRUCTIONS FOR THE MSP FORM #67A - CDS SUBMISSION

The MSP Request for Laboratory CDS Examination Chain of Custody Log / Laboratory Report Form #67A is used to record the items submitted, the chain of custody, and the laboratory results. This form, except for the chain of custody area, must be typed because of its multiple copies, and the fact that it will be presented in court. The copies of this form shall not be separated prior to submission.

Recovered CDS, along with the form, is delivered to the MSP Laboratory by the sworn property custodian for analysis. Our Agency copy will be returned with the CDS after testing. The Chain of Custody area of the form requires that the name of the person or place from whom the evidence was received and to whom the evidence was released be neatly printed and the date and time recorded. The section "Evidence Received By" requires a written signature.

The following information will assist in completing the form. Refer to Form #67A in the Agency Forms Directory and/or the CDS Packaging Guide at each district station.

- Installation / Agency: This is the arresting agency.
- Suspect: Full name of the suspect.
- Date of Offense: Enter the date in order of month, day, year.
- Crime Laboratory File No.: Leave the Crime Laboratory File No. block blank. This number will be assigned by the laboratory when the CDS is submitted for analysis.
- Case No.: Leave Blank.
- Property Held No.: This is your Agency's Case No. / Property Held No. Fill it in.
- County: County of occurrence.
- Asterisk (\*): It is important to indicate probable cause items(s) in the column provided with an asterisk (\*).
- How Collected: Indicate with an X the appropriate type of collection.
- Items: Correct wording is to be used as outlined in the CDS Packaging Guide. Fill in the items carefully with the most important item first (e.g., probable cause item(s)). List count (e.g., number of pills, but no weights on this form). Every item submitted may not be examined, depending on case load.
- Laboratory Report: Do not write in the heavily framed dark area. This area is for the report upon completion of analysis.
- Chain of Custody Area: Sign form as indicated at bottom in the chain of custody area. Make the signature legible.
- Blank Area: Leave blank - this block is reserved for the MSP Evidence Vault Stamp.

#### 4-524 SUBMITTING NARCOTICS FOR WHICH ANALYSIS IS NOT NECESSARY





Administrative and Operational Manual

September 12, 2022

Whenever a member submits narcotic-related property for other than prosecutorial action it shall be marked “for destruction.”

This property is to be packaged the same as any other.

#### 4-527 DESTRUCTION OF NARCOTICS

The destruction guidelines for narcotics are the same guidelines established by policy and the Special Services Division SOP. Only under rare circumstances will narcotics be returned to their owner. When narcotics are returned, the sworn Property Custodian shall follow the established guidelines as with any other property. When narcotics are set for destruction, the sworn Property Custodian must follow the policy established in the Special Services Division SOP.

The sworn property custodian shall be responsible for destroying narcotics. Therefore, all narcotic property will be re-inventoried to ensure the documented drugs / paraphernalia are present. This function will be attended by any two of the following witnesses:

- The sworn Property Custodian;
- Member of Office of Professional Responsibility;
- Commissioned officers of the Agency (Lieutenant or above);
- Member of the Narcotics / Vice Section.

After the drugs have been re-inventoried and sealed in boxes for destruction, the seal will be initialed by the witnesses.

The sworn Property Custodian and one of the official witnesses listed above shall transport the drugs to the appropriate destruction facility.

Destruction of the drugs shall be accomplished within six months after all legal requirements have been satisfied.

##### 4-527.1 INCINERATION OF DRUGS

The sealed boxes containing the drugs will be placed in the appropriate incinerator for destruction. The sworn property custodian and the witness shall remain until all narcotics have been completely destroyed.

##### 4-527.2 RECORDING NARCOTICS DESTRUCTION

The sworn property custodian shall ensure the final disposition of narcotics is marked “destroyed.”

The CDS Destruction Form #420 shall be completed in its entirety for all items destroyed. It shall be signed and dated by the sworn Property Custodian and witness.

#### 4-528 MEDICATION COLLECTION PROGRAM

CCSO has initiated a Citizen Medication Collection program to provide citizens with a safe and anonymous way of disposing of expired or unwanted drugs and medications. A drop box will be placed at each district station, available 24 hours a day, seven days a week.

In addition to providing citizens with a safe and secure way to dispose of prescription and over-the-counter drugs, it provides an environmentally friendly alternative to other methods of disposal. This program will aid in preventing accidental poisonings, reduce crime related to prescription drug abuse, burglary, and drug misuse by



Administrative and Operational Manual

September 12, 2022

children. Environmentally, it will help prevent tainted water supplies and will keep these drugs out of landfills.

Items accepted will be prescription drugs, over-the-counter medications, vitamins, and pet medicines. No needles or other sharp objects will be accepted. Plastic bags will be provided for citizens to place the drugs and medications in before dropping them into the drop box. There will be no forms to fill out and no questions will be asked.

This program will be administered by Property Management, which shall regularly collect and weigh the drop box contents, maintaining records of the quantity of drugs collected. Property Management will deliver the drugs and medications to an authorized destruction facility for destruction.

The keys to all medical drop boxes shall not be stored at the location of the medical drop boxes.

### 4-530 DNA EVIDENCE

DNA, or deoxyribonucleic acid, is the fundamental building block for an individual's entire genetic makeup. It is a component of virtually every cell in the human body. Further, a person's DNA is the same in every cell. For example, the DNA in a man's blood is the same as the DNA in his skin cells, semen, and saliva.

DNA is a powerful tool because each person's DNA, except for identical twins, is different from every other individual's. Because of that difference, DNA collected from a crime scene can, similar to the use of fingerprints, either link a suspect to the evidence or eliminate a suspect. DNA can also be used to identify a victim through their link with relatives, even when no body can be found. And, when evidence from one crime scene is compared with evidence from another, those crime scenes can be linked to the same perpetrator locally, statewide, and nationally.

Because of its potential evidentiary value, it is essential for Agency personnel to have a good understanding about where DNA can be found, and how to avoid contamination and preserve this sometimes fragile evidence.

All officers receive training on basic crime scene processing. Patrol's Crime Scene Processors (CSP's) receive supplementary training and members of the Forensic Science Section (FSS) are trained and have additional expertise pertaining to DNA evidence. Agency personnel will receive refresher training as needed in order to maintain proficiency and keep abreast of changes and advances in technology and procedures. Procedures learned during training and as outlined in this section and in the crime scene processing section of the AOM will be followed for the collection, storage, and transportation of DNA evidence.

Officers should be cautioned that because biological materials may contain hazardous pathogens such as the human immunodeficiency virus (HIV) and the hepatitis B virus that can cause potentially lethal diseases, samples of DNA evidence are to be treated as infectious materials.

DNA evidence can be collected from virtually anywhere. Because extremely small samples of DNA can be used as evidence, greater attention to contamination issues is necessary when identifying, collecting, and preserving DNA evidence. DNA evidence can be contaminated when DNA from another source gets mixed with DNA relevant to a case.

In order to avoid contamination of any evidence that may contain DNA, officers collecting the samples shall always take the following precautions:

- wear gloves and change them often;
- use disposable instruments or clean them thoroughly before and after handling each sample;
- avoid touching the area where you believe DNA may exist;



**Administrative and Operational Manual**

**September 12, 2022**

- avoid talking, sneezing, and coughing near the evidence;
- avoid touching their own face, nose, and mouth when collecting and packaging the evidence;
- air-dry evidence thoroughly before packaging;
- evidence will be placed into paper bags, envelopes or cartons; plastic bags and staples are not to be used; and
- individual samples will be maintained and packaged separately.

Given the sensitive nature of DNA evidence, officers should always contact FSS personnel when collection questions arise. Absent exigent circumstances, FSS shall have primary responsibility for the collection and processing of DNA evidence on all major crime scenes normally handled by CID.

The collection and preservation of the evidence will be as follows:

**Touch or Trace DNA**

"Touch" or "trace" DNA is simply a term used to describe the collection and analysis of microscopic amounts of cellular material. Mostly, this DNA is assumed to be from skin cells. Unlike most other types of genetic material, including blood, saliva, and semen, this genetic material cannot be seen with the naked eye. And there is no presumptive test to indicate whether the cells are present or not. The cells are cast off or are transferred from an individual and onto an item.

Collection involves using either wet or dry swabs, a scraping technique, or a tape lift technique, depending on the nature of the evidence involved. Once the cells are removed, they undergo the exact same laboratory procedure as standard DNA testing.

Touch DNA has expanded the types of items that can be considered physical evidence. Everything from gun and knife handles, to steering wheels, basically any physical object a suspect touched can be used to try to develop a DNA profile.

**Firearms**

- In the event a firearm will require DNA analysis, the laboratory which will be conducting the analysis will be consulted prior to any processing for instructions on the handling and submission of the evidence.

**Bodily Fluids - Wet Stain**

- The sample will be collected by using a sterile cotton swab and allowing it to be air dried.
- Upon being air dried, the cotton swab will be placed into a DNA evidence collection carton.
- The DNA evidence collection carton will be sealed, initialed, and stored in Property Held or an FSS freezer / refrigerator if it is not to be immediately prepared for transport to a DNA laboratory.

**Bodily Fluids - Dry Stain**

- The sample will be collected by dampening one (1) sterile cotton swab with sterile water prior to swabbing a dry stain.
- One (1) swab (dependent on the sample size) will be taken of each stain.
- The dampened stain swab will be allowed to dry.



## Administrative and Operational Manual

September 12, 2022

- The swab taken from the same stain will be placed into a DNA evidence collection carton.
- The DNA evidence collection cartons will be sealed, initialed, and stored in Property Held or an FSS freezer / refrigerator if they are not to be immediately prepared for transport to a DNA laboratory.

**Stains on Carpet, Walls, Clothing, and other Fabrics**

- The sample will be taken by collecting the entire item or, at the discretion of the collector, by cutting out the stained area from the item.
- The item(s) are to be allowed to air dry prior to being placed into a separate evidence envelope or brown paper bag for each item.
- The packaged items will be sealed, initialed, and stored in Property Held or an FSS freezer / refrigerator if they are not to be immediately prepared for transport to a DNA laboratory.

DNA evidence will be submitted only to an accredited laboratory for processing. The Maryland State Police Crime Lab will be the primary laboratory for our Agency. FSS must contact the MSP Crime Lab DNA Unit to discuss the type, quantity, and quality of evidence to be submitted. All preparation, packaging and transmittal of DNA evidence to the MSP Crime Lab will be in accordance with their guidelines.

In violent crime investigations, where the offender is unknown, submitted DNA evidence will be entered into the FBI Laboratory's CODIS (Combined DNA Index System) database. CODIS enables federal, state, and local crime labs to exchange and compare DNA profiles electronically, thereby linking crimes to each other and to convicted offenders.

**4-540 DIGITAL EVIDENCE**

Digital evidence is available in many forms. Physical digital evidence includes computers, mobile devices and flash memory. Intangible digital evidence includes digital video surveillance, digital photos and other data. The Digital Forensics Unit (DFU) is equipped to identify, process and recover digital evidence. The digital evidence landscape is dynamic and can change often. Recovery and submission procedures are designed to minimize the risk of data loss. Digital Forensics Examiners may be contacted via email at [dfu@ccso.us](mailto:dfu@ccso.us). Agency personnel may also request DFU response by contacting CID.

**4-540.1 DIGITAL EVIDENCE RECOVERY**

Computers, mobile devices and other digital evidence should be maintained in the same state as it was recovered. Two factors when seizing mobile devices are critical: *power state* and *network isolation*.

**Power State**

- **Maintain the *power state* of the recovered device. If the device is off, leave it off. If the device is on, leave it on.**
- **Maintain power to the device.** Devices powered on should be delivered to the DFU without delay to increase the chances to recover data from the devices.

**Network Isolation**

The device should be isolated from network connections to prevent changes. Bluetooth, Wi-Fi and Cellular are



Administrative and Operational Manual

September 12, 2022

examples of network connections. Devices can be isolated from network connections by taking the following steps:

- Attempt to place the device in **Airplane Mode**. Placing a mobile device into Airplane Mode effectively prevents a device from communicating on Cellular networks, and can also turn off other network connections.
- If a Bluetooth, Wi-Fi or other network connection remains active after placing the device in *Airplane Mode*, attempt to turn these connections off as well.
- Only if *Airplane Mode* is unavailable – remove the SIM, if equipped. The SIM, or Subscriber Identity Module, is a small physical card used to identify and authenticate the device to a cellular network. Tape the SIM, numbers facing up, to the back of the device, using clear tape.
- Devices that have not been isolated using these methods can be stored in a Faraday storage container to reduce or eliminate the ability of the device to connect to a network. Faraday storage containers include portable Faraday bags and Faraday boxes. Portable Faraday bags are available from the DFU. A Faraday box is available in CID.

Agency personnel should document their steps to isolate the device, including placing the device into *Airplane Mode* or removing the SIM, in their initial or supplement report.

**Power Adapters**

- The power adapter should be included with any submitted laptop computer, Digital Video Recorder (DVR) or other portable electronic device. These adapters are often unique to a particular model and not interchangeable. Including these adapters can reduce the processing time required.
- Power adapters are not needed for standard cellular phones, including Apple devices using the Lightning connector and Android devices using a Micro-USB or USB-C connector.

**General Handling Guidelines**

Digital evidence should be treated with care and has specific particular handling requirements.

- Digital evidence should be kept dry. Sealing a device from a moist environment in a container, including plastic, is not advised. Excessive heat, cold or recurring temperature changes should be avoided.
- Vibrations or physical shock should be avoided. Digital evidence should remain clear from strong magnetic fields, including magnets and speakers.

**4-540.2 DIGITAL EVIDENCE SUBMISSION**

**Physical Digital Evidence**

Physical digital evidence, including cellular phones and computers believed to contain evidence, may be submitted to the Digital Forensics Unit for processing. If other processing is required, digital evidence shall be submitted to the Forensic Science Section for latent or other processing *first*.

Submit physical digital evidence to the Digital Forensics Unit with the *Digital Forensics Request for Analysis*,



## Administrative and Operational Manual

September 12, 2022

Form #197, and search authority. Search authority includes a search warrant or consent search form. Other types of search authority must be articulated in writing. Form #197 includes a section to document the current power state and *Airplane Mode* status upon submission of mobile devices. These factors significantly affect device processing steps.

Devices may be submitted to the Digital Forensics Unit in person or by using the DFU secure storage lockers. Multiple devices from the same owner may be packaged in the same digital evidence box. When submitting devices via the DFU lockers, the following guidelines shall apply:

- The DFU short term storage lockers are listed as *Digital Forensics Short Term* in the Property Management System.
- DFU secure storage lockers are equipped with power connections for cellular phones and a lock to preserve chain of custody. The Faraday box in CID is also equipped with power connectors and a lock.
- An Evidence Label must be included with the device(s), but the device(s) need not be sealed in packaging. Devices remaining powered on generate heat that can damage a device sealed in a package.
- Include device(s), Evidence Label(s), *Digital Forensics Request for Analysis, Form #197* and a printed search authority in the locker.
- Lock the locker, remove the key, and drop the locker key in the DFU Locker Key Drop Box, also in CID.
- Email DFU to notify examiners about your submission.
- Should the *Digital Forensics Request for Analysis, Form #197* or search authority not be included with the device(s) in the locker, email these items to DFU immediately. The submitted devices may be refused and remain in storage without these required items.
- Devices submitted to DFU will generally be released to Property Held when processing is complete, unless other arrangements are made.

### ***On Scene Processing of Digital Evidence***

Certain devices should be processed on scene. These devices can include:

- network routers,
- business computers,
- networked security cameras, and
- Digital Video Recorders (DVR's).

A network router connects multiple devices and directs network traffic. Data may be lost if power is removed from network routers or security cameras. Seizure of a business computer or network device can involve multiple issues including data loss and unintended disruption of a legitimate business. Agency personnel should contact DFU for guidance before seizing a router, security camera or business computer.

**A Digital Video Recorder (DVR) should be processed on scene for surveillance video retrieval. The DVR may be seized for several reasons. The DVR can be seized to preserve the video evidence or to conduct recovery in a forensic environment. Agency personnel should consider that DVR seizure leaves the location without the benefit of security video for future incidents.**

**The DFU can process intangible digital evidence, including processing warrant returns or other technical assistance. Contact the DFU for assistance.**

### **4-540.3 DIGITAL SURVEILLANCE VIDEO RECOVERY**

Agency personnel should attempt to recover security video from a Digital Video Recorder (DVR) on scene and should note several DVR characteristics, including the DVR make, model, and the following times:

- the actual time,
- the DVR system time, and



## Administrative and Operational Manual

September 12, 2022

- the difference between the two times.

The time notations are used to establish the accurate date and time displayed in the recovered video. The actual time should be referenced using a trusted source, including an online cellular phone, and not necessarily a desktop computer system time.

Once recovered, the surveillance video may either be saved to disc or submitted to DIMS for preservation.

If recovery attempts are not successful, Agency personnel may request recovery from the DFU using the *Video Retrieval Request, Form #288*. This request form includes a section to specify the recovery timeframe, either based on *actual time* or displayed *DVR system times*. The DVR system time should be selected and listed on Form #288 only if the video has been reviewed and targeted events are associated with times displayed by the DVR system. This form should be completed and emailed to the DFU.

#### 4-540.4 DIGITAL SURVEILLANCE VIDEO CLARIFICATION

The Digital Forensics Unit can provide video clarification services. Some video can be processed to provide additional details. Submit this video to the DFU using the *Video Clarification Request, Form #149*

#### 4-560 THERMO SCIENTIFIC TRUNARC ANALYZER DEFINITIONS

**Laser Hazard Zone** – the area where the laser beam is strong enough to damage your eyes (14 inches from the laser)

**Self-Check**-a diagnostic test that verifies that the analyzer is operating according to its factory settings

**Self-Check Standard**-the movable plastic bar that is used during the analyzer self-check

#### 4-560.1 THERMO SCIENTIFIC TRUNARC ANALYZER

The Thermo Scientific TruNarc Analyzer is a 785-nm Raman spectrometer used for rapid identification of suspected narcotics. This system has the ability to identify, analyze and provide definitive results for:

- Narcotics;
- Stimulants;
- Depressants;
- Hallucinogens;
- Cough suppressants;
- Cutting agents; and
- Precursors.

The TruNarc Analyzer also has the ability to scan:

- Tablets;
- Capsules;
- Plastic bags;
- Jars;
- Bottles;
- Syringes;
- Crack pipes;
- Powders and large crystals;
- Pills; and
- Bricks of suspected CDS.

TruNarc Operators will not conduct scans or tests on tetrahydrocannabinol (THC) in any form, to include



Administrative and Operational Manual

September 12, 2022

vegetable matter or material. This material could become flammable due to the use of the Laser.

The Charles County Sheriff's Office has obtained three TruNarc Analyzers which are located within the Narcotics Enforcement Section and in secured lockers in all District Station processing areas. The TruNarc Analyzer located within the Narcotics Enforcement Section will be maintained by the designated officer in that unit.

The TruNarc Analyzers located at the District Stations are to be used in the processing area only, while at the stations. Due to the portability of these units, circumstances may arise where an analyzer needs to be transported to a scene. This will only be done with a supervisor's approval.

### 4-560.2 OPERATOR RESPONSIBILITIES

All operators of the TruNarc Analyzers must be certified. Before and after each scan, operators must conduct a **self-check** of the analyzer ensuring that the **self-check standard** is in the closed position. If the self-check fails, the test will be repeated until the **self-check** results in a pass. If the analyzer does not pass the self-check after several attempts, the unit cannot be used and the TruNarc Coordinator will be notified immediately.

Operators must complete the TruNarc Property Log (Form #162), which is located at the TruNarc locker site, for each scan or test that is completed.

TruNarc scanners have been accepted by the Charles County State's Attorney's Office as an accepted field test for charging purposes; however, all controlled dangerous substances will still need to be properly packaged and submitted to the Maryland State Police Laboratory for testing.

An example of an accepted probable cause statement would be:

- *I utilized the Thermo Scientific TruNarc Analyzer to conduct a field test on a sample from the suspected \_\_\_(Drug)\_\_. The result of this test was positive to the presence of \_\_\_(Drug Result)\_\_\_.*

Officers needing TruNarc reports generated for court purposes will send an email request with the Incident Report number to the TruNarc Coordinator at least 5 business days before that court date.

### 4-560.3 TRUNARC COORDINATOR RESPONSIBILITIES

The TruNarc coordinator for Patrol Operations will be designated by Patrol Division Commanders. The TruNarc coordinator for NES will be designated by the Commander, NES. Coordinators will be responsible for:

- Downloading the analyzers into the Thermo Scientific software program on a monthly basis;
- Updating the analyzers when prompted by the manufacturer;
- Checking battery life and charging the analyzers on a monthly basis;
- Generating reports when requested by the investigating officer or the State's Attorney's Office;
- Backing up all downloaded information to a folder in the agency server on a monthly basis;
- Inspecting, cleaning and maintaining the analyzers on a monthly basis; and
- Maintaining adequate supplies in the various processing areas.

### 4-560.4 SAFETY PRECAUTIONS

Due to the strength of the TruNarc Analyzer's laser and the potential for eye damage, and the ignition of heat sensitive and explosive materials, TruNarc operators:

- Will not perform a scan directly on a dark surface;
- Will not perform a scan on heat sensitive and explosive materials;







Administrative and Operational Manual

September 12, 2022

[Redacted text block]

[Redacted text block]

[Redacted text block]

[Redacted text block]

- [Redacted list item]
- [Redacted list item]

[Redacted text block]

[Redacted text block]



## Administrative and Operational Manual

September 12, 2022

## 4-600 ARRESTS

The law of arrest in Maryland is found in common law and statutory form. Arrest is the taking into custody of a person. In order to constitute an arrest, there must be either a touching of the body (which may be of the lightest kind), or there must be notification of the purpose to arrest and submission thereto.

The basic distinction in Maryland law is that made between a felony and a misdemeanor. Generally, the law allows an officer to make an arrest without a warrant for a felony, but restricts the right in misdemeanor cases.

All arrests call for probable cause to exist. Probable cause to arrest exists where the facts and surrounding circumstances justify a reasonable belief that a crime has been committed and that the person to be arrested has committed it.

All sworn police officers who have been certified by the Maryland Police Training and Standards Commission are authorized by law to make arrests.

### 4-600.1 ARREST WARRANTS

An arrest warrant is a written order by a judicial officer commanding the police to arrest the person named in the warrant.

An arrest warrant must be signed by the judicial officer issuing it, set forth the time and place of making it, and the charge or offense. Arrest warrants may be executed by sworn law enforcement officers only.

When a warrant is placed in the hands of an officer he is not bound to inquire into the particulars of the complaint, or whether any was made at all. If the warrant is in due form and issued by a person having a right to issue it, the duty of the officer is to execute it without further inquiry, and the warrant will protect him.

The Supreme Court has recognized the Police Team concept. If any law enforcement officer holds a warrant, it is deemed held by all. Whenever an arrest is made based on this concept, the officer making the arrest must verify the information as soon as practical.

### 4-600.2 WARRANTLESS ARRESTS

A police officer may arrest without a warrant any person who commits, or attempts to commit, any felony or misdemeanor in the presence of, or within the view of, such officer.

A police officer who has probable cause to believe that a felony or misdemeanor is being committed in the officer's presence or within the officer's view, may arrest without a warrant any person whom the officer may reasonably believe to have committed such offense.

A police officer may arrest a person without a warrant if the officer has probable cause to believe that a felony has been committed or attempted and that such person has committed or attempted to commit a felony whether or not in the officer's presence or view.

A police officer may arrest a person without a warrant if the officer has probable cause to believe that the person battered that person's spouse or other individual with whom the person resides, there is evidence of physical injury, a report to the police was made within 48 hours of the alleged incident and the three circumstances listed below for a misdemeanor arrest are met (see AOM Section 4-233).

A police officer may arrest a person without a warrant, for a misdemeanor, if the officer has probable cause to believe that one of the listed offenses in Criminal Procedure, § 2-203 of the Annotated Code of Maryland has been



## Administrative and Operational Manual

September 12, 2022

committed; that the person has committed the offense; and that unless the person is immediately arrested:

- the person may not be apprehended;
- the person may cause injury to the person or damage to the property of one or more other persons; or
- the person may tamper with, dispose of, or destroy evidence.

Officers are authorized to make probable cause arrests for the following misdemeanor offenses specified in Criminal Procedure:

- offenses relating to malicious burning;
- offenses relating to carrying or wearing weapons;
- destroying, injuring, etc., property of another;
- giving a false alarm of a fire;
- possession of hypodermic syringes;
- theft where the value of the property stolen is less than \$300;
- offenses relating to drugs and other dangerous substances;
- offenses relating to handguns;
- manslaughter by automobile;
- indecent exposure; and
- attempts to commit any of the offenses specified above.

### 4-600.3 VIOLATIONS OF PRETRIAL AND POSTTRIAL CONDITIONS OF RELEASE

#### PURPOSE

Maryland Law, 5-213.1 of the Criminal Procedures Article, make it a criminal violation for a person to violate certain conditions of pretrial or post trial release. These violations are misdemeanors and the violator is subject to arrest by a law enforcement officer.

#### DEFINITIONS

**Pretrial Release** means the period of time the person is released from custody and is awaiting trial.

**Post trial Release** means the period of time the person is released from custody while awaiting sentencing for a conviction and/or the period of time the person is placed on probation after a conviction.

**Crime of Violence** in this policy retains its meaning under § 5-101 of the Public Safety Article. These crimes include:

- abduction;
- arson in the first degree;
- assault in the first or second degree;
- burglary in the first, second or third degree;
- carjacking and armed carjacking;
- escape in the first degree;
- kidnapping;
- voluntary manslaughter;
- maiming as previously proscribed under former Article 27, § 386 of the Code;
- mayhem as previously proscribed under former Article 27, § 384 of the Code;
- murder in the first or second degree;
- rape in the first or second degree;
- robbery and robbery with a dangerous weapon;



## Administrative and Operational Manual

September 12, 2022

- sexual offense in the first, second or third degree;
- home invasion under § 6-202 (b) of the Criminal Law Article;
- an attempt to commit any of the crimes listed in this subsection; or
- assault with intent to commit any of the crimes listed in this subsection or a crime punishable by imprisonment for more than 1 year

A person who is **Entitled to Relief** retains the same meaning as listed in the CCSO's Domestic Violence policy under 4-233.6 of the AOM.

**Sexual Crimes Against a Minor** in this policy means any crime under Title 3, subtitle 3 of the Criminal Law Article. These crimes include:

- rape and attempted rape in the first and second degree;
- sex offense and attempted sex offense in the first and second degree;
- sex offense in the third and fourth degree;
- sexual conduct between a correctional, DJS employee or court ordered service provider and an inmate or confined child;
- continuing course of conduct with a child;
- sodomy;
- unnatural or perverted sexual practice;
- incest;
- sexual solicitation of a minor;
- use of personal identifying information or the identity of another.

#### 4-600.4 DETERMINING CONDITIONS OF RELEASE

If an officer believes a person may have committed a violation of release, the officer must first determine the crime the person has been charged with and determine what conditions of release have been placed on the subject, if any. This will be accomplished by having the Communications Section run the person's name through Maryland's Secure Case Search. This is a database maintained by the Maryland Judiciary. This will return the person's criminal charge and their current conditions of release. Once the person's information is returned by Secure Case Search, the Communications Officer will provide the information to the requesting officer.

#### 4-600.5 VIOLATIONS – CONDITIONS OF RELEASE

Based on the conditions of release and the specific circumstances and actions of the person on release the officer will determine if they have probable cause to make the arrest.

An officer may make an arrest of an individual if they have probable cause to believe they are or have violated a pretrial or post trial condition which prohibited the person from:

- contacting;
- harassing, or
- abusing an alleged victim, or
- going in or near the alleged victim's residence or place of employment.

Violations of these conditions are only for people who are charged with committing three categories of criminal violations:

- sexual crimes against a minor;
- crimes of violence; or
- a crime against a victim who is entitled to relief under Family Law § 4-501 for domestic violence.



Administrative and Operational Manual

September 12, 2022

An officer with probable cause to believe the person has committed a violation of this statute may make a warrantless arrest in accordance with § 2-203 of the Criminal Procedures Article.

A person arrest for violation of condition of pretrial or post trial release for a crime other than a sexual crime against a minor shall be issued a citation for the offense.

## 4-601 ARRESTS BY COMMISSIONED SPECIAL POLICE OFFICER (SPO)

In order to promote cooperation and efficient operations between the Charles County Sheriff's Office and Commissioned Special Police Officers, the following procedures must be adhered to.

### 4-601.1 ARREST OF AN ADULT

**The Commissioned SPO will:**

- complete a Statement of Charges document;
- complete an Arrest Report Form #80;
- turn over the prisoner, Statement of Charges and Arrest Report to the responding CCSO officer; and
- forward a copy of his Offense / Incident Report Form #20 to the State's Attorney's Office.

**The responding CCSO officer will:**

- verify the commission of the SPO;
- review the Statement of Charges document to ensure that probable cause exists and pertinent information is recorded;
- review the completed Arrest Report;
- take custody of and transport the prisoner with documents to the Detention Center; and
- follow established procedures in processing and appearance before the District Court Commissioner.

The CCSO Records Section will process all related documents and maintain these records in accordance with established procedures.

## 4-602 APPREHENSION OF ADULT BY OTHER THAN COMMISSIONED SPO

**Misdemeanor:**

- If identity is established to the CCSO officer's satisfaction and the suspect is a resident of Maryland and not wanted, the officer will:
  - release the suspect;
  - prepare an Offense / Incident Report; and
  - make application for a charging document to be served at a later date.
- If the suspect has no identification or the responding officer has reasonable suspicion to believe it may be false, or the suspect is not a Maryland resident, the officer will arrest the suspect in accordance with Criminal Procedure (Arrest by Police Officer Without a Warrant).

**Felony:**



## Administrative and Operational Manual

September 12, 2022

- If probable cause exists that a felony was committed and the suspect did commit it, the responding officer will arrest in accordance with Criminal Procedure.

#### 4-603 ARREST OF FUGITIVE FROM ANOTHER JURISDICTION

Officers having prior knowledge of an individual in this jurisdiction being a fugitive shall make every attempt to obtain a true test copy of the warrant prior to an arrest being made.

The Commander of the Special Services Division or his designee shall oversee all proceedings involving fugitives.

Whenever a sworn member of this Agency has contact with a person (adult or juvenile) for whom an extraditable warrant or writ from an agency outside the State of Maryland exists, the person, after verification, will be taken into custody as a fugitive from justice. If the suspect is arrested for committing an offense in this jurisdiction, the officer will complete the standard arrest procedures and attach a copy of the computer verification printout. The suspect will not be charged as a fugitive until the local charges are disposed of.

If a sworn officer from another jurisdiction outside the State of Maryland presents a warrant, other charging document, or teletype for a person alleged to be in Charles County and they want to attempt service of a fugitive warrant, officers of this Agency will assist. If there is any question regarding the warrant, it should be verified through METERS / NCIC. If an arrest is effected, the person will be turned over to this Agency where he will be charged as a fugitive and taken before a judicial officer.

It is against both Agency policy and the law to turn over a prisoner to a demanding jurisdiction outside the State of Maryland without first completing the appropriate legal process.

All related paperwork (including teletypes) pertaining to the fugitive processes must be completed and turned in to Records Management before the end of the officer's tour of duty. Copies of all related paperwork (including teletypes) must be forwarded to the supervisor of the Warrant / Fugitive Unit immediately upon completion, prior to the officer's securing from his tour of duty.

##### 4-603.1 FUGITIVE FROM JUSTICE - DISTRICT OF COLUMBIA (NO LOCAL CHARGES)

The following procedures shall be adhered to when handling a person wanted on criminal charges in the District of Columbia:

- The Officer shall confirm the warrant through Judicial Services or Communications.
- If the warrant is confirmed, the Officer must determine which court in the District of Columbia issued the warrant – either a federal court or the Superior Court of the District of Columbia.
- When the warrant is issued by the Superior Court of the District of Columbia, Maryland law treats the District of Columbia as another State and requires the suspect to be charged as a fugitive from justice.
- When the warrant is issued by a federal court in the District of Columbia, the suspect does not need to be charged as a fugitive from justice. The suspect should be transported to the Charles County Detention Center to await pickup by federal agents.
- The arresting officer shall prepare an Arrest Report and have the suspect fingerprinted and photographed per the Charles County Sheriff's Office policy.
- The Intake/Records Officer at the Charles County Detention Center shall contact the U.S. Marshal's



## Administrative and Operational Manual

September 12, 2022

Service, District of Columbia Office, at (202) 616-8640, 8641, 8642, or 8643, Monday through Friday, from 0730 to 1500 hours, to make arrangements for the fugitive's pick-up as soon as possible. Normally, the fugitive should be picked up within twenty-four (24) hours.

- Occasionally, the U.S. Marshal's will not be able to pick up the fugitive within twenty-four hours. When this occurs, a Request for Temporary Commitment should be completed and presented to the District Court Commissioner. The form can be obtained from the District Court Commissioner and must be signed by a Federal Law Enforcement Officer. The Federal Officer does not have to sign the form in person. A faxed or emailed copy is acceptable.

#### 4-604 ARREST OF ILLEGAL ALIENS

When a person is booked on any criminal charge and is also suspected of being an illegal alien, the arresting officer shall:

- Contact the Immigration and Naturalization Service to ascertain the individual's immigration status.
- If the information is available from Immigration and Naturalization Service, it will be contained on the bottom of the Arrest Report.

**NOTE:** Officers shall not initiate arrests merely to determine a suspect's alien status.

#### 4-605 ARREST OF FOREIGN NATIONALS

Any person who is not a native born or naturalized United States citizen is considered a foreign national. Whenever a foreign national is arrested or detained in the United States, there may be legal requirements to ensure that the foreign national's government is notified to provide a consular from the individual's embassy. In some instances, a foreign national may be a citizen from a country who has entered into agreements with the U.S. government to provide mandatory notification when one of their citizens has been arrested or detained. In other cases, it is not a mandatory requirement; however, it is the responsibility of the officer to notify the individual of his right to a consular from his embassy. In all instances of arrest or detention, officers will advise a foreign national his right of consular notification. This notice of notification should be provided in writing, signed and dated by the foreign national and copies attached to all paperwork generated by this incident.

- Copies of written notifications in various foreign languages are provided at CCDC in the Intake / Records section.
- If a particular language is not available or if the individual cannot read, the officer will contact the Bureau of Consular Affairs at the U.S. State Department (202) 647-1512 for assistance.
- A current list of all mandatory notification countries and how to contact their embassies will be maintained at CCDC as well as a list of all foreign embassies in the U.S.

If it is determined a notification is going to be made either because it is mandatory or at the request of the foreign national, officers will:

- fax a written notification of the arrest or detention of the foreign national to the respective embassy;
- obtain a fax verification from the fax machine where the notice was sent;
- attach a copy of the consular notification, notification of arrest and fax verification to the Offense / Incident





---

Report or arrest documentation completed by the arresting officer and a copy given to CCDC Intake / Records.

**NOTE:** This policy does not apply to those with diplomatic immunity. See Section 4-239 for policy dealing with diplomats.

#### **4-605.1 DETENTION CENTER RESPONSIBILITIES**

Officers assigned Intake / Records responsibilities at CCDC will monitor all arrests to ensure all appropriate notifications are attached to reports submitted on the arrest or detention of foreign nationals to CCDC. The arresting officer will be required to submit these documents prior to CCDC accepting the prisoner.



Administrative and Operational Manual

September 12, 2022

[REDACTED]

[REDACTED]

- [REDACTED]
- [REDACTED]
- [REDACTED]

[REDACTED]

[REDACTED]

[REDACTED]

[REDACTED]

[REDACTED]

[REDACTED]

- [REDACTED]
- [REDACTED]
- [REDACTED]
- [REDACTED]
- [REDACTED]
- [REDACTED]
- [REDACTED]

[REDACTED]

[REDACTED]

[REDACTED]



Administrative and Operational Manual

September 12, 2022

[REDACTED]

[REDACTED]

[REDACTED]

[REDACTED]

[REDACTED]

[REDACTED]

[REDACTED]

[REDACTED]

- [REDACTED]
- [REDACTED]
- [REDACTED]
- [REDACTED]

[REDACTED]

[REDACTED]



Administrative and Operational Manual

September 12, 2022

---

[REDACTED]

[REDACTED]

[REDACTED]

[REDACTED]

- [REDACTED]
- [REDACTED]
- [REDACTED]
- [REDACTED]

[REDACTED]

[REDACTED]

[REDACTED]

[REDACTED]

- [REDACTED]
- [REDACTED]
- [REDACTED]
- [REDACTED]
- [REDACTED]
- [REDACTED]
- [REDACTED]

[REDACTED]

[REDACTED]

[REDACTED]

[REDACTED]

[REDACTED]

- [REDACTED]
- [REDACTED]
- [REDACTED]
- [REDACTED]



Administrative and Operational Manual

September 12, 2022

- | [REDACTED]
  - | [REDACTED]
  - | [REDACTED]
  - | [REDACTED]
  - | [REDACTED]
  - | [REDACTED]

- | [REDACTED]
  - | [REDACTED]

[REDACTED] [REDACTED]

[REDACTED]

- | [REDACTED]
- | [REDACTED]
- | [REDACTED]
- | [REDACTED]

[REDACTED]  
[REDACTED]

[REDACTED]  
[REDACTED]  
[REDACTED]

[REDACTED] [REDACTED]

[REDACTED]

- | [REDACTED]
- | [REDACTED]
- | [REDACTED]
- | [REDACTED]

[REDACTED] [REDACTED]

[REDACTED]  
[REDACTED]

[REDACTED] [REDACTED]



[REDACTED]

[REDACTED]

[REDACTED]

[REDACTED]

[REDACTED]

[REDACTED]

[REDACTED]

[REDACTED]



## Administrative and Operational Manual

September 12, 2022

## 4-607 EXEMPTIONS TO ARREST

Friendly foreign Sovereigns and their attendants, their Ambassadors and other diplomatic agents, public ministers and their attendants, and households are generally exempt from arrest (see Section 4-239 of the AOM).

No person belonging to the organized militia shall be arrested on any process except such as may be issued by military authority, while going to, remaining at, or returning from any place at which he may be required to attend for military duty.

United States Senators and Representatives shall in all cases, except treason, felony, and breach of the peace, be privileged from arrest during their attendance at the session of their respective houses, and in going to and returning from the same. This protection to members of Congress is given by the Constitution of the United States.

### 4-607.1 RELEASE OF PERSONS FROM ARREST

If, after an arrest based upon probable cause, it becomes apparent that there is no probable cause to continue to hold the arrestee (e.g., there was probable cause to arrest for CDS, but upon search no CDS was recovered; or an individual was arrested on a warrant, but after further investigation the warrant could not be validated), the arrestee may be released under the following condition:

- The officer is satisfied that there are insufficient grounds to continue to hold the arrestee and to file a criminal complaint against the person arrested
- The officer shall assure the arrestee is released at a safe location and is not otherwise placed at risk as a result of the release. If necessary, the arresting officer shall assure that the arrestee is provided transportation to a safe location.
- In cases where the arrestee has already been charged at CCDC, the release must be processed through the District Court Commissioner.
- Any record of arrest of a person released shall include a notation that the arrestee was released without the filing of formal charges and provide the reason(s) for the release.
- The officer shall document the release of the arrestee. If the event prompted an incident report, the release shall be detailed in the incident report. If no incident report was written, the release shall be detailed in a field interview report (FIR).

Where the release of an arrestee is contemplated due to a medical condition and hospitalization prior to the booking process, the arresting officer shall confer with his supervisor and have the concurrence of a command level officer. In this situation, the commanding officer shall, before authorizing the release, consider the following:

- Whether it is feasible to file charging documents against the arrestee at a later date;
- The nature of the offense;
- Confirmation of the arrestee's name and identification;
- The arrestee's listed home address;
- The expected duration of the medical care;



Administrative and Operational Manual

September 12, 2022

- Prior criminal history to include FTA;
- Whether releasing the arrestee creates a known danger to the public or property.

The Command Officer shall notify his chain of command of the decision at the earliest convenience.

#### 4-607.2 CRIMINAL DEBRIEFING REPORT

The Criminal Debriefing Report was created to provide police officers with a method for collecting intelligence information, crime tips, and other valuable information. This information will be distributed to and accessed by investigators throughout the Agency to aid in the closure of cases, the arrest of wanted individuals, the identification of suspects, and other law enforcement purposes.

It is mandatory for all sworn officers, regardless of assignment, to complete the Criminal Debriefing Report following any and ALL arrests. The Debriefing Report should also be utilized when intelligence is gathered during any citizen, suspect, or witness encounter. It is located on the Agency Intranet under the "Reports" heading.

The information gathered will be distributed to the appropriate section commander. The commander will then distribute the information to the proper unit(s) for follow-up action. The data will also go to a central intelligence file in Keystone, where the data will be sorted and stored for future search and analysis by all officers of the Agency.

Notifications are not mandatory; however, if the information gathered is time sensitive or of a critical nature, a notification should be immediately made to the proper Agency section. If there is doubt as to whether a notification should be made, the investigator's supervisor or commander should be consulted.

Only those sections of the report that pertain to the information gathered need to be completed, in as much detail as possible. The type of information will vary widely from case to case. Whatever information is gathered should be documented on the report. The more precise the data that is received, the more valuable and searchable it will be in the future.





Administrative and Operational Manual

September 12, 2022

---

## **4-608 USE OF RESTRAINING DEVICES - GENERALLY**

When a prisoner is taken into custody, handcuffs will be used. The prisoner will be searched and secured with his hands behind his back if possible. Handcuffs will be double locked. If a prisoner's hands must be secured in front, they will be secured by a waist chain or they may be secured using the subject's belt, with the buckle behind the prisoner's back.

When transporting prisoners who have a physical disability, illness or are obviously no physical threat (for example, young children, elderly persons, paraplegics, etc.), officers may use their discretion in using handcuffs.

Leg irons, flex-cuffs, or other authorized devices may be used to secure disorderly or violent prisoners.

### **4-608.1 USE OF EXPECTORANT SHIELDS**

The expectorant shield is a nylon mesh device designed to fit over the head and face of a prisoner to prevent him from projecting expectorant or blood onto Agency employees. One (1) shield will be issued to each sworn employee to be used for health and safety purposes when encountering violent, in-custody persons who are spitting at law enforcement personnel or who are bleeding from the head / face area.

The device is a safe and humane form of restraint which allows unrestricted breathing and shall be used only for its intended purpose.

When the shield is utilized, its use and the circumstances necessitating its use shall be documented in the associated report. The application of the shield to any person will require continuous monitoring of that person. This will be accomplished by the actual physical presence of a sworn employee for the entire time the person is wearing the device. At no time will the person be left unattended while the shield is being worn.

As soon as it is deemed safe to do so, or at the direction of a supervisor, the shield will be removed and as soon as is practical, disposed of in a bio-hazard container located in the intake area of the Detention Center or in any of the district stations. This is a single use, disposable item and is not to be laundered or reused under any circumstances.

Following the use of the expectorant shield, the officer shall obtain a replacement through the Quartermaster. The use of an expectorant shield will be documented in an Incident Report or in the Call Sheet in cases where an Incident Report is not completed.



Administrative and Operational Manual

September 12, 2022

[REDACTED]

[REDACTED]

[REDACTED]

[REDACTED]

[REDACTED]

[REDACTED]

[REDACTED]

[REDACTED]

[REDACTED]

[REDACTED]

[REDACTED]

[REDACTED]





Administrative and Operational Manual

September 12, 2022

[Redacted text block]

[Redacted text block]

[Redacted text block]

[Redacted text block]

[Redacted text block]

- [Redacted list item]
- [Redacted list item]

[Redacted text block]

[Redacted text block]

[Redacted text block]

[Redacted text block]

[Redacted text block]

[Redacted text block]



Administrative and Operational Manual

September 12, 2022

[REDACTED]

- [REDACTED]
- [REDACTED]
- [REDACTED]

[REDACTED]

[REDACTED]

[REDACTED]

[REDACTED]

[REDACTED]

[REDACTED]

[REDACTED]

[REDACTED]

[REDACTED]

[REDACTED]

[REDACTED]



Administrative and Operational Manual

September 12, 2022

[Redacted text block]

[Redacted text block]

[Redacted text block]

[Redacted text block]

[Redacted text block]

[Redacted text block]

[Redacted text block]

[Redacted text block]

[Redacted text block]

[Redacted text block]

[Redacted text block]



Administrative and Operational Manual

September 12, 2022

[REDACTED]

[REDACTED]

[REDACTED]

[REDACTED]

[REDACTED]

[REDACTED]

[REDACTED]

[REDACTED]

[REDACTED]

[REDACTED]

[REDACTED]

[REDACTED]

[REDACTED]

[REDACTED]

[REDACTED]

[REDACTED]

[REDACTED]

[REDACTED]

[REDACTED]



---

[REDACTED]

[REDACTED]

- [REDACTED]
- [REDACTED]
- [REDACTED]
- [REDACTED]
- [REDACTED]
- [REDACTED]





Administrative and Operational Manual

September 12, 2022

[Redacted text block]

- [Redacted list item 1]
- [Redacted list item 2]
- [Redacted list item 3]
- [Redacted list item 4]

[Redacted text block]

- [Redacted list item 1]
- [Redacted list item 2]
- [Redacted list item 3]
- [Redacted list item 4]
- [Redacted list item 5]

[Redacted text block]

[Redacted text block]

[Redacted text block]

[Redacted text block]

- [Redacted list item 1]
- [Redacted list item 2]



Administrative and Operational Manual

September 12, 2022

- [REDACTED]

- [REDACTED]

[REDACTED]

[REDACTED]

[REDACTED]

[REDACTED]

[REDACTED]

[REDACTED]

- [REDACTED]
- [REDACTED]
- [REDACTED]
- [REDACTED]

[REDACTED]

[REDACTED]

[REDACTED]

[REDACTED]



---

[Redacted text block]

[Redacted text block]

[Redacted text block]

- [Redacted list item]
- [Redacted list item]

[Redacted text block]



## Administrative and Operational Manual

September 12, 2022

## 4-611 SEARCH OF ARRESTEES – SWORN

This section applies to searches incident to arrest conducted by sworn officers. Procedures relating to searches of arrestees by correctional officers are controlled by 5-206 of the Detention Center Standard Operation Policy and Procedure Manual.

### 4.611.1 DEFINITIONS

**Gender Classification:** “Male” or “female.” An arrestee’s gender will be classified as it appears on the individual’s government-issued identification card *unless* the arrestee provides a different gender identity. In the event a government-issued identification card is unavailable, or the arrestee’s gender identity is unspecified or unclear, an officer may respectfully ask for clarification.

**Gender Identity:** The gender-related identity, appearance, expression, or behavior of a person regardless of the person’s assigned sex at birth. Gender identity may be demonstrated by consistent and uniform assertion of the person’s gender identity or any other evidence that the gender identity is sincerely held as part of the person’s core identity.

**Manual body cavity search** means some degree of touching or probing of body cavities by someone other than the arrestee.

**Private area** means the aureole of the female breast, the pubic and genital region of all genders, and the crevice of the buttocks of all genders.

**Sexually invasive search** means the exposure of an individual’s private areas to any other person.

**Visual body cavity search** means the visual inspection of a private area.

### 4.611.2 SEARCHES – GENERAL PROCEDURE

Arrestees will be searched upon arrest. If exigent circumstances require the quick removal of an arrestee from a scene, a quick pat-down for weapons may occur followed by a more thorough search after moving a safe distance from the scene. Each officer who accepts custody of the arrestee will also search the arrestee.

Searches of an arrestee shall include the arrestee’s person and areas that are within the arrestee’s immediate control, including any containers such as purses or backpacks that the arrestee is carrying.

### 4-611.3 SEARCHES BY GENDER

Generally, arrestees will be searched by an officer of the same gender classification. Searches may occur by an officer of a different gender if exigent circumstances require the search, such as:

- The arrestee is likely to be armed;
- A delay in a search may result in the destruction or loss of evidence; or
- No officer of the same gender as the arrestee is readily available.



## Administrative and Operational Manual

September 12, 2022

Attempts to locate an officer of the same gender classification will be noted in the event call sheet.

If an officer of the same gender classification is not readily available, the arresting officer should not engage in a sexually invasive search unless exigent circumstances compel such a search. When an officer searches a prisoner of another gender classification, the officer will have a witness present if possible and conduct the search out of public view or in a private setting.

When searching an arrestee of another gender classification, the searching officer will use the back of the hand while searching around intimate areas – breasts for female identifying arrestees and genitals for both gender classifications.

#### 4-611.4 SEXUALLY INVASIVE SEARCHES

**When a sexually invasive search may occur:**

A search incident to arrest does not automatically allow a sexually invasive search. A sexually invasive search is permitted only when there is reasonable suspicion to believe that drugs, a weapon, or contraband may be found hidden in or near the private area of the arrestee. The nature of the offense may play a substantial role in determining whether reasonable suspicion exists but should not be the sole basis for conducting a sexually invasive search.

**Where and how a sexually invasive search may occur:**

All reasonable steps must be taken to ensure the privacy of an arrestee before a sexually invasive search may occur. Reasonable steps include:

- ensuring that the arrestee's private parts are exposed to as few people as possible;
- conducting the search away from view of members of the public;
- using the least intrusive means available to conduct the search (for example, having an arrestee pull her underwear away from her body allowing the officer to look in protects privacy more than having the arrestee remove her underwear).

Except in extreme circumstances, sexually invasive searches must be conducted by, and only witnessed by, officers of the same gender classification as the arrestee.

Manual body cavity searches should not occur without either a search warrant with qualified medical assistance or as part of appropriate medical treatment unless there are exigent health or safety circumstances that require an immediate search.

Officers with reasonable suspicion to believe the arrestee has weapons, drugs, or contraband concealed in or near a private area should request that a sexually invasive search be conducted by correctional officers at the Detention Center.

Any officer conducting a sexually invasive search outside of a secure location such as a district station or the Detention Center must be able to articulate why the search could not be delayed until the arrestee was taken to a secure location. Unless exigent health or safety circumstances require otherwise, a visual body cavity search that involves removing clothing should occur in a secure location.

Officers should consider a subject's mental capacity and a juvenile's age when assessing the justification, place, and manner of the search.



## Administrative and Operational Manual

September 12, 2022

**4-611.5 SEARCH OF THE MOUTH**

When an officer reasonably believes an arrestee has secreted contraband within the mouth, the officer may order an arrestee to remove such contraband and may under certain circumstances use force to search the mouth. Before using manual force, all of the following conditions must be present:

- there must be a lawful arrest of the person based upon probable cause;
- there must be a clear indication (more than mere suspicion) the arrestee has secreted a seizeable item (e.g. illegal drugs, weapon, handcuff key, etc.) within the mouth;
- there must be a search warrant authorizing an intrusion into the arrestee's mouth, or exigent circumstances, such as:
  - imminent destruction of evidence; and/or
  - a medical emergency.

Once the prerequisites have been satisfied, an officer may use objectively reasonable force to extract contraband secreted in the arrestee's mouth. In determining whether the use of force is objectively reasonable, the officer should consider the totality of the circumstances and take into account:

- the safety and health of the arrestee;
- the arrestee's dignity interest in personal privacy and bodily integrity; and
- the community's interest in fairly and accurately determining the person's guilt or innocence.

Officers who have received training are permitted to use pressure point and other techniques as taught in the Academy to extract contraband. The following techniques are prohibited:

- applying force to the arrestee's throat sufficient enough to prevent him/her from breathing or obstructing the person's blood supply;
- forcibly inserting fingers into the arrestee's mouth;
- threatening lethal force in any manner; or
- striking the arrestee on or about the head.

When an officer reasonably believes an arrestee has ingested contraband that could have a negative effect upon his / her health, the officer shall:

- immediately seek medical attention for the arrestee;
- inform medical personnel of the facts, as known by the officer, regarding the arrestee's ingestion of the contraband;
- offer no advice, instruction, direction, or make any request or suggestion to the medical personnel concerning any particular medical course of action or treatment;
- remain readily available at the site where the arrestee is receiving medical attention; and



Administrative and Operational Manual

September 12, 2022

- collect any evidence that becomes available.

The use of force is not justified if an officer reasonably believes the seizeable item(s) in the arrestee's mouth would be accessible to recovery and identification in a supervised, post-arrest setting and the contraband in the arrestee's mouth is not causing a medical emergency. An officer may reasonably believe a medical emergency exists when an arrestee appears to become ill, exhibits other evidence of medical difficulty or loses consciousness.

#### 4-611.6 REPORTING REQUIREMENTS

The officer making the arrest and/or conducting a strip or manual body cavity search must prepare an Incident Report identifying:

- the person searched;
- the date, time and location of the search;
- the specific reasons for the search;
- the manner in which the search was done;
- the scope of the search;
- any other persons present or involved in conducting the search; and
- whether contraband and/or weapons were recovered.

If force is used to effect a search, a Use of Force / Discharge of Firearm Report Form #226 will also be completed.

The above policy is exclusive of searches not involving sworn personnel, conducted by Corrections personnel within the CCDC. Searches conducted by Corrections personnel will be guided by policies contained in the CCDC's SOP manual.

#### 4-612 REMOVAL OF PROPERTY ITEMS FROM PRISONERS

All prisoners will be searched upon arrival at a district station or the Detention Center, and all property will be removed from them, except the following:

- Clothing being worn;
- Shoes (laces removed);
- Personal papers;
- Eyeglasses / contact lenses.

#### 4-612.1 RELEASE OF PROPERTY TO PERSON OTHER THAN PRISONER

Release of the prisoner's property to a private person is prohibited unless the prisoner gives his expressed consent to do so.

#### 4-613 BOOKING PROCEDURES - OBTAINING ID NUMBERS

ID numbers for adult arrests and juveniles arrested and processed are obtained through the Detention Center Central Process Section. Care should be taken to ensure that an arrested individual who was assigned an ID number during a prior arrest is not assigned a new ID number.



## Administrative and Operational Manual

September 12, 2022

### 4-613.1 REFUSAL (OR INABILITY) TO PROVIDE INFORMATION FOR BOOKING PROCEDURES

When a prisoner refuses to provide information for the arrest record, the officer will indicate same by noting "refused" or "unable to answer" in the appropriate block.

### 4-613.2 JOHN / JANE DOE ARRESTS

When a prisoner's identity cannot be established, he will be carried on all paperwork as John / Jane Doe. These prisoners will be committed by the District Court Commissioner and incarcerated until identified. When identified, the processing officer will complete the arrest records with the correct information and forward to the Records Section.

### 4-613.3 ARRESTEE'S AGE NOT DETERMINED

When the arresting officer cannot establish the arrestee's age, he will be charged as an adult, unless the officer can reasonably assume by observation that the arrestee is a juvenile.

When a juvenile charged as an adult is later discovered to be a juvenile, the arresting officer will submit an Offense / Incident Report to Records and complete the appropriate forms to be forwarded to Department of Juvenile Services.

### 4-613.4 PRISONERS REFUSING TO BE FINGERPRINTED OR PHOTOGRAPHED

Prisoners who refuse to be fingerprinted or photographed will not be taken before the District Court Commissioner until the process is completed.

### 4-613.5 STATEMENT OF CHARGES - ARREST BOOKING SYSTEM

Adult prisoners brought to the detention center on original criminal charges will be processed through the Arrest Booking System. This is an automated computer system which generates a Statement of Charges and tracking number utilized by the courts to associate a particular individual to a case. Tracking numbers will be copied to the front and back of the green and white MSP Fingerprint Card. An additional two (2) tracking numbers can be placed on the MSP Fingerprint Card above the signature line if needed.

In the event of a system failure of the Arrest Booking System, the detention center will maintain a supply of court issued Statement of Charges forms. These forms are accounted for with a court assigned tracking number. In the event one is to be voided, it must be turned in to Records Section, via the chain of command, accompanied by a dated, signed memorandum explaining the reason it is to be voided.

Only the top section (peel-off label) must be typed. The remaining portion may be typed or neatly hand written. The peel-off labels with the court tracking number will be affixed to the green and white MSP Fingerprint Card in the areas designated for tracking.

**NOTE:** Court Case numbers associated with District or Circuit Court Warrants are different than Tracking Numbers.

### 4-613.6 PROCESSING ADULTS

**Criminal / Civil Charges** - When processing an adult in connection with any initial, or subsequent F.T.A., V.O.P., or Contempt, etc., **Criminal or Civil Related Arrest** (via Arrest Warrant, Statement of Charges, Bench Warrant,





Administrative and Operational Manual

September 12, 2022

---

Body Attachment, Writ of Attachment, Parole Retake, or other Warrant), in addition to an Arrest Report, the officer shall obtain:

- 2 red and white FBI Fingerprint Cards;
- 1 green and white MSP Fingerprint Card;
- 1 black and white CCSO Palm Print Card;
- CCSO Placard Mug Shots per established procedures;
- Color Photograph(s) as appropriate (all initially charged felonies, CDS cases, or whenever the photo may aid in an investigation).

AND

If serving four (4) or more charging documents on the same defendant, add:

- 1 green and white MSP Palm Print Card.

**Traffic Charges** - When processing an adult in connection with any initial, or subsequent F.T.A., V.O.P., or Contempt, etc., **Traffic Related Arrest**, in addition to an Arrest Report, the officer shall obtain:

- 1 red and white FBI Fingerprint Card;
- 1 black and white CCSO Palm Print Card;
- CCSO Placard Mug Shots per established procedures.



## Administrative and Operational Manual

September 12, 2022

## 4-614 CRIMINAL SUMMONS SERVICE

When serving a defendant with a District Court Criminal Summons on Charging Document, or a Circuit Court Summons with Criminal Information / Indictment, the officer shall complete an Arrest Report, except when the document originated outside of Charles County.

### 4-614.1 CRIMINAL SUMMONS PROCEDURE

Criminal summons issued by the Commissioner for Charles County Sheriff's Office cases or cases investigated by the Town of La Plata Police Department will be handled as follows:

- Monday through Friday, new criminal summons will be picked up from the Commissioner by the Warrant / Fugitive Unit, and processed by Judicial Services;
- The summons will be distributed to the district stations where the applying officer is assigned and placed at the front desks of the district stations;
- The District 3 / 4 location will contain summons for Waldorf Patrol, CID, and the Cops officers with offices in District 3 / 4;
- The District 1 location will contain summons for La Plata Patrol, Cops officers with offices in the Annex, and summons for the Town of La Plata Police Department;
- The District 2 location will contain summons for Indian Head Patrol officers;
- Criminal summons issued on behalf of School Resource Officers will be housed at the district station for the district in which their assigned school is located;
- An email will be sent to the officer who applied for the charges, notifying them a summons is at the front desk for service. This email will also be sent to their supervisor;
- Once an officer receives the email, they should check the front desk and attempt service of the summons;
- If the summons is going to be removed from the box for attempts, the officer must sign out the summons on the log sheet kept at the front desk;
- The summons must be returned to the front desk at the end of the officer's tour of duty. **No summons can be left in vehicles or officers' mailboxes when not on duty;**
- All attempts should be noted on the sheet stapled to the inside of the folder. Phone calls and the outcome of the call count as attempts and need to be recorded on the sheet;
- If the summons is served, return the folder to the front desk in the "served summons" section / folder;
- If the attempts to serve the summons reveal all known numbers and addresses are no good and there are no investigative leads left to explore, then the summons can be placed in the served section with notes;
- Have the police station technician clear the summons as served in the Agency computer system.



## Administrative and Operational Manual

September 12, 2022

## 4-614.2 SERVING CRIMINAL SUMMONS

Serving a criminal summons will require the defendant to sign four (4) places. The defendant will get the last copy of the summons, the officer must sign and fill out the top two (2) copies, and an arrest report must be completed. When serving a criminal summons, complete the following steps:

- The summons will be in a folder that contains the following:
  - an arrest report;
  - three (3) copies of the criminal summons;
  - local history sheets;
  - an MVA print out; and
  - NCIC Wanted print out.
- The first step is to complete the arrest report with current information (same as an on-scene arrest);
- Complete a wanted check of the defendant;
- Remove the last copy of the summons (stamped “defendant copy”) - this copy does not need to be signed by the defendant or the officer;
- Explain to the defendant the summons is a paper charging them with a crime. In lieu of being physically arrested, the defendant is allowed to sign the charging paper, indicating they promise to show up in court. Show them the spot near the bottom that says they are not admitting guilt by signing the paper, simply promising to come to court;
- Next, show them the Preliminary Inquiry (PI) date located near the top where it tells them to appear in court on a certain date;
- Then show and explain the pages after the front page. There will be a page that tells the charge and penalty, a page with the public defender’s information, a page advising their rights to an attorney, and finally a copy of the Application for Charges.
- Next, have the defendant sign the summons. There are four (4) places they need to sign. On the first copy of the summons marked “court copy” they need to sign the bottom where it says “signature of Defendant”. Also on the first copy, they will need to sign the bottoms of the “advice of rights” page and the page with the public defender information, which should be the third and fourth pages. The fourth spot is on the front page of the second copy marked “law enforcement copy”, they need to sign the front page of this copy in the “signature of Defendant” spot.
- After the defendant leaves, the officer needs to fill out the service part on the front pages of both copies.
- The only variation from these instructions will be if the defendant refuses to sign the summons. If this occurs, check the third block down “defendant refused to accept / sign”. This block would also be used if the officer spoke with the defendant and they advised they are not going to meet the officer or come to pick it up. If this happens, the officer needs to check the block and sign the bottom of all three copies, then put the summons in the served folder at the front desk.
- Once criminal charges have been filed, the defendant has a right to counsel under the sixth amendment to the United States Constitution. If the officer serving a summons wishes to interview the defendant about the charges, the officer must first advise the defendant of his rights by reading from the Advice of Rights card supplied by the State’s Attorney’s Office. The defendant does not have the right to prompt presentment



---

to a District Court Commissioner. The officer may then interview the defendant regarding the Charges only if the defendant affirmatively waives his right to counsel.

#### **4-615 COURT ORDERED FINGERPRINTING**

The courts may direct a convicted defendant, who had not been previously fingerprinted for a charge, to appear to be fingerprinted. Therefore, the following procedures will be necessary:

- The individual shall be identified by providing proper identification. If necessary, CCSO Arrest Records may be used for this purpose.
- The individual shall be fully processed in accordance with the established adult criminal arrest procedures.
- The court order shall be signed (or have a return of service / compliance made on it).
- If the person appears without the Court Order (but does have a Temporary Authorization Form, or other paperwork from Parole and Probation that orders the fingerprinting), proceed as if the Order was received.
- All documents shall be submitted to the Central Processing Section.



## Administrative and Operational Manual

September 12, 2022

## 4-616 INTERVIEWS AND INTERROGATIONS

Interviews are conversations between a police officer and any person(s) possessing relevant information concerning a crime. Witness or victim interviews do not require an advice of rights. Once an interview passes from information gathering to an accusatory state, it may be considered an interrogation.

While interviews and interrogations of adults and juveniles are generally handled the same, certain factors should be taken into consideration when dealing with juveniles. These factors are described within section 4-625 of this manual.

### 4-616.1 INTERROGATION OF SUSPECT AND/OR PRISONER

It is necessary to give the Miranda Warning only when there is custody and interrogation. No statements shall be obtained as a result of any promises, threats or inducements.

A person who is in custody must be advised of his constitutional rights prior to any interrogation. Until such rights are given, no evidence obtained as a result of a custodial interrogation can be used against the person. If requested, a suspect must be allowed access to legal counsel.

When a person in custody waives his / her rights, it is also necessary that such waiver constitute a knowing, intelligent and voluntary waiver.

In many cases, it is not necessary for an officer to advise a suspect of his Miranda rights immediately on the scene of the suspect's apprehension. Therefore, when a suspect is taken into custody and is to be turned over to a detective for follow-up investigation, the apprehending officer will not advise the suspect of his Miranda rights, unless the circumstances of the case necessitate immediate interrogation of the suspect.

The officer who turns a suspect over to a detective will, in all cases, advise whether or not the suspect has been given his Miranda advisement of rights. If the Miranda warning has not already been made, it will become the detective's responsibility to ensure the suspect is advised of his Miranda rights.

### 4-616.2 FIELD INTERVIEWS

The field interview is an important point of contact for officers in preventing and investigating criminal activity. Officers will conduct field interviews in conformance with procedures set forth in this policy.

Officers may stop individuals for the purpose of conducting field interviews only where reasonable / articulable suspicion is present. Reasonable / articulable suspicion does not need to meet the same test for probable cause sufficient to make an arrest. Officers must be able to articulate the reasons for the stop and be able to point to specific facts that, when taken together reasonably, led the officer to believe or suspect that a crime has been committed or is about to be committed. Such facts may include, but are not limited to the following examples. However, many of these examples alone may not reach the level of reasonable / articulable suspicion:

- the actions, appearance or demeanor of an individual suggests involvement in a criminal enterprise or in criminal activity;
- the hour of the day or night is inappropriate for the subject's presence in the area;
- the subject is carrying a suspicious object or has bulges in his clothing that suggests he is carrying a weapon;
- the subject is located in proximity to a recent crime;



Administrative and Operational Manual

September 12, 2022

- the officer knows of the subject's prior criminal record or involvement in criminal activity;
- the officer notes other circumstances or behavior which arouse his suspicion.

Officers must consider the facts that may rise to the level of reasonable / articulable suspicion. It is the combination of facts and circumstances along with the reasonable inferences drawn from those circumstances that give rise to articulable suspicion.

Officers should understand that an individual's mere presence in a public place in itself is not sufficient reasonable / articulable suspicion to conduct any investigative stop.

Nothing in this policy should be construed as preventing an officer from engaging in a consensual citizen contact.

When approaching a suspicious person, officers will identify themselves and, if not in uniform, will display identification.

Officers will attempt to be courteous at all times during the contact but maintain caution and alertness for any movements to retrieve weapons, conceal or discard contraband, or other suspicious actions.

Before approaching more than one suspicious person, individual officers should determine whether the circumstances warrant a request for backup assistance and whether the contact can be delayed until such assistance arrives.

Officers will confine questions to those concerning the suspect's identity, place of residence, reason for presence at the location and other inquiries necessary to resolve the officer's suspicions.

Field interviews are non-custodial. Officers are not required to give Miranda warnings in order to conduct field interviews.

Individuals are not required, nor can they be compelled, to answer any questions posed during field interviews. Failure to respond to an officer's inquiries is not, in and of itself, sufficient grounds to make an arrest although it may provide sufficient justification for additional observation and investigation.

Officers have the right to frisk the outer garments of suspects for weapons if the suspect is legitimately stopped and there is reasonable / articulable suspicion the subject may be armed and presents a danger to the officer.

In the event a field interview results in the establishment of probable cause for an arrest, all of the facts related to the initiation of the field interview and any search will be clearly articulated within the resulting Offense / Incident Report filed by the arresting officer.

When no arrest is made, the field interview will be documented on the Warning / FIR / Security Notice Form #389. This form is an investigative tool for developing suspects for various crimes. All blocks and the summary area of the form must be as complete as possible. A case number will be obtained and recorded on the form.

Officers will retain copy #4 and forward the other copies to Records Management. The suspect is not provided a copy of a FIR.

#### **4-617 MARYLAND COURT RULE 4-212 PRESENTMENT BEFORE A JUDICIAL OFFICER**

This Maryland Court of Appeals ruling requires immediate presentment of a defendant before a judicial officer subsequent to arrest. Presentment will be without unnecessary delay and within 24 hours. In all cases, the defendant will be promptly provided with his copy of charging documents. Presentment may be delayed for the



## Administrative and Operational Manual

September 12, 2022

following procedures:

- completion of reports; and/or
- identification processing.

Delays in taking a defendant before a Commissioner, for the purpose of interviews or line-ups may not render a confession inadmissible. Such delays, however, will be taken into consideration by the courts when considering the voluntariness of a confession.

## 4-618 PRISONER ESCAPES

Following the escape of any prisoner from police custody, the custody officer shall immediately broadcast a comprehensive lookout and take the following actions:

- give an exact location of the escape and last known direction of travel;
- give a full physical, clothing description and name of the prisoner;
- provide officer safety information (is the prisoner armed?);
- give the nature of the instant criminal charge;
- request a supervisor to respond; and
- if warranted, request a K-9 unit and air support to assist in the search.

The custody officer will assist in the search effort. Regardless of whether the escapee is located, the custody officer shall complete an Offense / Incident Report containing the details of the escape, and a Commanders' Information Report. If the escapee is not immediately located, the custody officer shall also be responsible for applying for the charges for escape against the prisoner.

Upon notification of an escape, Communications supervisors will notify OPR, who will decide if response to the scene is warranted. If response is determined to be warranted, Communications supervisors will notify on-scene supervision / command that OPR will be responding. OPR will review each report of escape to determine the need for remedial training, change of policy, or disciplinary action necessary.

A supervisor shall determine the scope of any search based on the danger to the community, nature of the charge(s) and likelihood that the prisoner may be located later. When circumstances require an immediate and extensive search, the supervisor will:

- request additional manpower to establish perimeters of the search area;
- until relieved by a superior, command the scene and act as the contact person for K-9 unit, air support, and officers from outside agencies assisting with the search;
- direct a notification to be made to the appropriate district / shift commander and the division commander of the custody officer;
- delegate the responsibilities of the custody officer to another officer, if the original custody officer is unable to fulfill them (incapacitated);

The supervisor will brief the appropriate district / shift commander with all available information in an effort to determine the need for additional action to be taken. These actions may include:

- deploying additional manpower to the search area;
- conducting neighborhood canvasses;
- directing teletype / lookout be sent to appropriate jurisdictions;
- coordinating search efforts with neighboring jurisdictions, if warranted;



## Administrative and Operational Manual

September 12, 2022

- contacting the MRO to coordinate assistance from and notification to the media.

The supervisor of the custody officer shall initiate an administrative investigation into the escape in order to determine if any Agency policies were violated and if any changes in policies or procedures are needed to prevent a reoccurrence.

If an escape occurs outside of Charles County, the custody officer will immediately notify the jurisdiction in which the escape occurred. Charles County Communications shall also be notified, and if the incident occurred within a reasonable distance of the County, a supervisor will be dispatched to respond.

All possible cooperation will be provided to the local jurisdiction. All notifications, reports and investigations required for an in-County escape will be completed.

## 4-619 NOTICE OF SECURITY RISK

An officer who observes unusual behavior or overhears threatening comments of a prisoner in his custody which leads the officer to believe the prisoner may be a risk to himself or others will complete a "Notice Of Security Risk."

### 4-619.1 DISTRIBUTION

A copy of this notice will be given to any police officer, correctional officer, court security officer, intelligence investigator, or intake official as a means of documenting they were made aware of the prisoner's unusual behavior. The notice does not place any specific requirements on the accepting official.

### 4-619.2 NOTICE FORM

Officers will use CCSO Warning / FIR / Security Notice Form #389 to record the following information:

- "Security Notice" will be checked on the form;
- Identifying information: name, date of birth of prisoner;
- a short summary of the unusual behavior or threats / comments and name of person receiving custody;
- the primary charge or reason why prisoner is in custody;
- signature of the official receiving a copy of the notice along with the date and time provided;
- signature and ID number of the officer completing the notice;
- event / case number (prior to submission to Records); and

The official accepting custody of the prisoner will be given copy two (2) of the completed notice. The completing officer will retain copy four (4) and the remaining copies will be forwarded to Records Management. A copy of the completed Form #389 will be forwarded to the Southern Maryland Information Center for review.

### 4-619.3 SUMMARY

While the content of the summary portion of the notice does not need to be greatly detailed, it will include a description of the observed unusual behavior or threatening comments.

Example: An officer makes a traffic stop and discovers the driver of the vehicle has an active warrant with another agency. Arrangements are made to turn the prisoner over at the County line. While conducting a search, several handcuff keys are found hidden in the prisoner's clothing. The prisoner makes comments concerning his hate for





Administrative and Operational Manual

September 12, 2022

police and his desire to do harm to any officer if given the chance. In this example, the prisoner could be considered an escape risk and a threat to officer safety. A "Notice of Security Risk" would be completed prior to turning the prisoner over to the officer from the other agency. The summary portion could simply state, "Made verbal threats toward police officers, and handcuff keys were found hidden in his clothing."

While the example describes a prisoner exchange with another agency, the notice will be completed and provided to members of this Agency when appropriate. This includes intake personnel at the Detention Center and court security personnel. It may also include Juvenile Justice officials or members of the State's Attorney's office.

#### 4-619.4 EVENT NUMBER AND RECORDS

The event / case number will be written on the completed notice prior to forwarding the copies to Records. The completion of this notice does not require a secondary event listing. The event number generated for the transport or incident is sufficient. Once received by Records Management, the completed notice will be processed in the same manner as FIRs. Officers may use the FIR block on Monthly Performance Reports to record the number of "Notice of Security Risk" reports completed.



## Administrative and Operational Manual

September 12, 2022

## 4-620 JUVENILE PROCEDURES

The Charles County Sheriff's Office is committed to the development and perpetuation of programs designed to prevent and control juvenile crime. All members of the Agency must take responsibility for, and share in, this goal.

Officers handling incidents involving juvenile offenders should give consideration to using the least coercive method available, among all reasonable alternatives, for dealing with each case, to include:

- warning and outright release with no further action;
- release to a parent, legal guardian, or other responsible adult, with no further action;
- warnings and parental notification;
- use of written citations; and/or
- completion of a Juvenile Offense Report (JOR) and referral to the Department of Juvenile Services.

When making decisions regarding the handling of juvenile matters, officers should take into consideration the nature of the offense, the age and circumstances of the offender, and the offender's prior record.

Agency referral of juvenile offenders for formal legal proceedings should be restricted to those cases involving serious criminal conduct or repeated criminal violations. In general, delinquent acts requiring referral to the juvenile justice system would include:

- all delinquent acts constituting felonies;
- all acts involving weapons;
- all serious gang-related acts;
- all acts involving aggravated assault and battery;
- all acts committed by juveniles on probation or those with a case pending before the courts; and
- all repeated delinquent acts (within the preceding 12 months).

### 4-620.1 DEFINITIONS

**DETAINED** - Formally held pending release to DJS, DSS, parent, relative, guardian, or other. Can be in an informal, non-secure room.

**SECURELY DETAINED** - Detention of an individual in locked cell / room or handcuffed to a stationary object.

**JUVENILE** - Any person under the age of 18 (whether under Juvenile or Criminal Court jurisdiction) or a person between the ages of 18 and 21 who is still under Juvenile Court jurisdiction.

**STUDENT** - an individual enrolled in a public school system or non-public school in the state who is 5 years of age or older and under 22 years of age.

**ACCUSED JUVENILE (ACCU)** - A juvenile accused of a chargeable offense.

**ADJUDICATED JUVENILE (ADJU)** - A juvenile who has been before either the Juvenile or Adult Court and a determination has been made.

**DELINQUENT OFFENDER (DEL)** - A juvenile who has been charged with an offense for which an adult can also be charged, but who is subject to the jurisdiction of the Juvenile Court.

**STATUS OFFENDER (CINS)** - A juvenile who has been accused or adjudicated for an offense for which adults cannot be charged. Status offenses include:



## Administrative and Operational Manual

September 12, 2022

- Runaway
- Truancy
- Incurable
- Underage drinking
- Curfew violations (if applicable, only to juveniles)

**NON OFFENDER (CINA)** - A juvenile who is not charged with any offense, usually a child in need of supervision or assistance.

#### 4-620.2 TAKING JUVENILES INTO CUSTODY

A juvenile may be taken into custody by any of the following methods:

- Pursuant to an order of the court;
- By a law enforcement officer pursuant to the law of warrantless arrest (Criminal Procedure, § 2-203; or, Education Article, § 26-104(e) [Paggers at School]; or, The Family Law Article, § 4-509(b) [Violating an Order of Ex Parte or Protection]; or, Transportation Article, § 26-202);
- By a law enforcement officer or other person authorized by the court if there are reasonable grounds to believe the juvenile is in immediate danger from his / her surroundings and that this removal is necessary for his protection;
- By a law enforcement officer or other person authorized by the court if there are reasonable grounds to believe the juvenile has run away from his parents, guardian or legal custodian.

#### 4-620.3 NOTIFICATION OF CUSTODY

When a law enforcement officer takes a juvenile into custody under this authority, the juvenile's parent(s), guardian, or custodian must be notified the child was taken into custody and provided with all appropriate information concerning the circumstances that would not compromise an investigation. This notification will be made as soon as possible, preferably upon arrival at a CCSO facility, but in all cases within 48 hours. All attempts to notify parents will be documented.

In accordance with the Education Article (ED § 7-303 (b)) of the Annotated Code of Maryland, if a student is enrolled in any public or private school and is arrested for a reportable offense, the Superintendent of Schools and school principal must be notified of the arrest and charges.

#### 4-620.4 REPORTABLE OFFENSES

Reportable offenses are those offenses in Criminal Law, § 14-101 defined as "crimes of violence" and include:

- abduction;
- kidnapping;
- manslaughter (except involuntary manslaughter);
- mayhem and maiming;
- murder;



Administrative and Operational Manual

September 12, 2022

- 
- rape;
  - child abuse in the first degree;
  - robbery / robbery with a deadly weapon;
  - carjacking or armed carjacking, attempted carjacking;
  - sexual offense in the first, second, or third degree / attempted sexual offense in the first or second degree;
  - sexual abuse of a minor if the victim is under the age of 13 years and the offender is an adult at the time of the offense; and the offense involved: (1) vaginal intercourse, (2) sexual act, (3) an act in which a part of the offender's body penetrates, however slightly into the victim's genital opening or anus; or (4) the intentional touching, not through the clothing, of the victim's or the offender's genital, anal, or other intimate area for sexual arousal, gratification, or abuse;
  - continuing course of conduct against a child (three or more acts of rape, second degree rape, sexual offense in the first, second or third degree);
  - use of a handgun in the commission of a felony or other crime of violence;
    - sale, transfer, or disposal of a stolen regulated firearm;
    - assault in the first degree;
    - assault with intent to murder / rape / rob;
    - assault with intent to commit a sexual offense in the first degree / second degree;
    - using, wearing, carrying, or transporting a firearm during and in relation to a drug trafficking crime;
    - use of a firearm under § 5-622;
    - possession of dangerous or deadly weapons;
    - wearing, carrying or transporting a handgun;
    - use of a handgun or antique firearm in the commission of a crime;
    - manufacturing, distributing, possessing with intent to distribute, or dispensing CDS;
    - equipment to produce CDS;
    - counterfeit substance to include counterfeit CDS or its container or labeling;
    - keeping common nuisance;
    - false prescription;
    - narcotic drug, schedule I or schedule II hallucinogenic substances;
    - volume dealer, drug kingpin, importer of CDS;



## Administrative and Operational Manual

September 12, 2022

- distributing fake CDS;
- possession or purchase of non-controlled substance where person believes to be CDS;
- CDS near school;
- use of a minor under § 5-268 of the Criminal Law Article "hire, solicit, engage or use a minor to manufacture, deliver, or distribute on behalf of a person CDS in sufficient quantity to reasonably indicate under all the circumstances an intent to distribute the CDS";
- manufacture / possession of a destructive device, a false statement concerning a destructive device, or a representation of a destructive device;
- arson / malicious burning in the first or second degree; and
- criminal gang activity / criminal gang activity in schools.

The Courts and Judicial Proceedings Article (CJ § 3-8A-03(d)(4)), adds to the above:

- third degree sexual offense in violation of Crim. Law § 3-307(a)(1);
- possession or use of a machine gun;
- illegal sales or possession of firearms;
- possession of a "sawed off" rifle or shotgun;
- violations involving assault weapons; and
- using, wearing, carrying, or transporting of a firearm during, and in relation to, a drug trafficking crime.

Criminal Law § 4-101 adds the wearing or carrying of any dirk knife, Bowie knife, switchblade knife, star knife, sandclub, metal knuckles, razor, nunchaku, or any other dangerous or deadly weapon of any kind concealed upon or about the person or openly with the intent to unlawfully injure another or who carries chemical mace, pepper mace, or tear gas device with the intent to unlawfully injure. They also add the carrying or possession of a deadly weapon on school property and the wearing, carrying or transporting of a handgun at any time.

#### **4-620.5 ARRESTING OFFICER'S RESPONSIBILITIES**

When an officer arrests any student enrolled in a public or private elementary, middle or high school in Maryland, the officer shall make notification to the School Resources Section by the end of his shift and record the notification in the Incident Report and on the JOR or Arrest Report. The notification will be made by email using the School Notification Format created by ITD or, if not available, by telephone. The email notification will automatically go to the School Resources Unit Supervisors and the Commander, School Resources Section.

#### **4-620.6 SUPERVISORS' RESPONSIBILITIES**

The arresting officer's supervisor shall ensure when a student has been arrested, the notification to the School Resource Unit has been made and noted in the Incident Report and on the JOR or Arrest Report.

#### **4-620.7 RESPONSIBILITIES OF SCHOOL RESOURCES UNITS**

Upon notification of a student's arrest, the School Resources Officer Unit Supervisor(s) will verify the charge qualifies as a reportable offense. If it does qualify, notifications shall be made to the appropriate officials. In the case of a public school student, the Superintendent, Director of School Safety & Security, school principal and school resource officer will be notified. In the case of a student attending a non-public school, the person responsible for



## Administrative and Operational Manual

September 12, 2022

the facility (school principal, director or other top management personnel) will be notified. In rare cases when a non-public school student has interactions with the public school system, notifications will be made to all listed officials.

#### 4-620.8 RELEASE OF JUVENILES

When an arresting officer is making a request to place a juvenile in detention for a criminal arrest, the officer shall follow the intake request procedures posted on the Agency Intranet under Division Links>Patrol>Juvenile Detention Procedures. These procedures will link the arresting officer with the intake system of the Department of Juvenile Services.

After giving the required notice or making every reasonable effort to give notice, the officer shall with all reasonable speed:

- release the juvenile to the parent(s), guardian, or custodian upon their written promise to bring the juvenile before the court when requested to do so. A signature is required for recognizance at the bottom portion of the Juvenile Offense Report (JOR) Form #28. After signing, the parent, guardian, or custodian will be provided with the pink copy of the JOR; or
- deliver the juvenile to the court or place of detention or shelter care if so directed by the court on a Writ of Attachment, or if so directed by an Intake Officer.

In the event a parent, guardian, or custodian cannot be contacted, or refuses to sign for and/or accept custody of the juvenile, the officer shall contact a Department of Juvenile Services Intake Officer for direction.

Prior to release, the officer shall contact an Intake Officer of The Department of Juvenile Services-(regarding possible detention authorization) if the officer becomes aware the juvenile is already on probation, or it appears likely that the juvenile will leave the jurisdiction of the court, or if the juvenile stands charged with:

- a crime of violence; or
- a violation of the handgun laws; or
- a serious weapons violation; or
- any crime that, upon reviewing the totality of the circumstances, indicates to the officer that, if the juvenile were to be released, he may pose a danger to himself or to another.

#### 4-621 CRIMES INVOLVING JUVENILES (NO PHYSICAL ARREST)

There will be times when a juvenile has fled the jurisdiction, or it is unnecessary, or legally impossible to make a physical custodial arrest of a juvenile suspected of committing a delinquent act (crime).

During these occasions the officer shall conduct a complete and thorough investigation to aid the State's Attorney in any possible future prosecution of the case.

The officer shall document the investigation on an Offense / Incident Report Form #20 per established guidelines, and complete a Juvenile Offense Report Form #28.

The officer shall make every reasonable effort to notify the parent(s), guardians, or custodian of the allegations and have them sign the recognizance (bottom) portion of the Juvenile Offense Report, prior to it being submitted to Records. Whenever the juvenile is charged criminally, an arrest report shall be completed in Police Mobile.

In most cases, if properly explained that the signature is merely a recognizance promise to produce the juvenile if requested to do so, the signature will be obtained, in lieu of the officer having to request a Writ of Attachment, which



Administrative and Operational Manual

September 12, 2022

may result in the subsequent physical custodial arrest of the juvenile.

Upon obtaining the requested signature, (or making every reasonable effort to) the officer shall submit the Juvenile Offense Report and the Offense / Incident Report or Supplemental Report as appropriate. At that time, for Charles County Sheriff's Office reporting purposes, the case shall be marked CLOSED WITH ARREST, listing the juvenile as ACCUSED in the report.

Completed Offense / Incident Reports and Juvenile Offense Reports will be forwarded to The Department of Juvenile Services and the State's Attorney's Office by Records personnel. The officer submitting the report(s) need not call The Department of Juvenile Services regarding disposition on any action taken by them (since the case is closed by arrest).

#### 4-621.1 IDENTITY OF JUVENILE

In any case being investigated where the juvenile cannot properly establish identification, etc., to the officer's satisfaction, and the parent(s), guardian or custodian cannot be contacted to establish identity, the officer may deem the juvenile to be a possible runaway and may take him into physical custody under that presumption (Chapter 4, Section 620). Inaccurate information as to identity, address, etc., makes it extremely difficult, if not impossible, for The Department of Juvenile Services to proceed with an action against a juvenile.



Administrative and Operational Manual

September 12, 2022

4-622 GUIDE TO CHARGING THE JUVENILE OFFENDER (Matrix)

Age	Charge / Violation	Charging Document	Offense Report
14 and older	<ul style="list-style-type: none"> <li>* 1<sup>st</sup> Degree:               <ul style="list-style-type: none"> <li>- Murder</li> <li>- Rape</li> <li>- Sexual Offense</li> </ul> </li> <li>* Dynamiting / Bombing Property (Criminal Law, § 4-503)</li> <li>* Conspiracy or Attempt to Commit any of the above</li> </ul>	(As Adult) Statement of Charges or Arrest Warrant	Yes
16 and older	<ul style="list-style-type: none"> <li>* Abduction</li> <li>* Kidnapping</li> <li>* 2<sup>nd</sup> Degree               <ul style="list-style-type: none"> <li>- Murder</li> <li>- Rape</li> <li>- Sexual Offense</li> </ul> </li> <li>* Manslaughter (Voluntary)</li> <li>* Armed Robbery</li> <li>* 3<sup>rd</sup> Degree Sexual Offense (Criminal Law, § 3-307)</li> <li>* Any handgun, rifle, shotgun, machine gun or assault weapon violation specified in Criminal Law</li> <li>* Any firearm violation (while drug trafficking or by convicted felon) specified in Criminal Law, § 5-621 or Criminal Law, § 5-622</li> <li>* Carjacking / Armed Carjacking (Criminal Law, § 3-405)</li> <li>* 1<sup>st</sup> Degree Assault (Criminal Law, § 3-202)</li> <li>* Attempt Murder in the 2<sup>nd</sup> Degree</li> <li>* Attempt Rape or Sexual Offense</li> <li>* Attempt Robbery with a dangerous or deadly weapon</li> <li>* A child who previously has been convicted as an adult of a felony and is subsequently alleged to have committed an act that would be a felony if committed by an adult</li> </ul>	(As Adult) Statement of Charges or Arrest Warrant	Yes

\* AND ALL OTHER CHARGES ARISING OUT OF ANY OF THE ABOVE INCIDENTS.





Administrative and Operational Manual

September 12, 2022

4-622 (continued)

<u>Age</u>	<u>Charge / Violation</u>	<u>Charging Document</u>	<u>Offense Report</u>
16 or 17	* Any jailable violation of the Transportation Article (located in TR § 27-101)	J.O.R.	Yes

**\* ALL OTHER CHARGES ARISING OUT OF ANY OF THE ABOVE INCIDENTS.**

16 or 17	All Non-Jailable Violations of the Transportation Article	Maryland Uniform Complaint and Citation (Form #DR-49)	No
----------	---	---	----

Under 16	All Violations of the Transportation Article or State Boat Act	J.O.R. (If appropriate to charge)	Yes
----------	--	-----------------------------------	-----

Under 18	All Civil Alcohol Violations Specified in Criminal Law, Title 10, Subtitle 1; or in the Education Article, § 26-103.	Uniform Juvenile Civil Citation for Alcohol and Tobacco Offenses (Form #DC-31)	No
----------	--	--	----

**NOTE:** FINGERPRINTS AND APPROPRIATE PHOTOGRAPHS ARE REQUIRED ONLY IF THE JUVENILE HAS BEEN PHYSICALLY ARRESTED AND TAKEN INTO CUSTODY.



Administrative and Operational Manual

September 12, 2022

## 4-623 PROCESSING JUVENILES

All juveniles physically arrested for the purpose of filing a criminal prosecution, delinquency petition, or pursuant to a Writ of Attachment, shall be processed as outlined in this section.

### 4-623.1 CHARGED AS ADULTS

(Arrest Warrant, Statement of Charges, Bench Warrant, etc.):

- 2 red and white FBI Fingerprint Cards
- 1 green and white MSP Fingerprint Card
- 1 black and white CCSO Palm Print Card
- 1 green FBI Disposition Sheet

CCSO Placard Mug Shots per established procedures

Color photograph(s) as appropriate (all felonies, CDS cases, or when the photo may aid in an investigation).

AND

If serving four (4) or more (adult) charging documents on the same defendant, add:

- 1 green and white MSP Palm Print Card

### 4-623.2 CHARGED AS JUVENILES

(J.O.R. or Writ of Attachment):

- 1 red and white FBI Fingerprint Card
- 1 green and white MSP Fingerprint Card
- 1 black and white CCSO Palm Print Card
- Color picture(s) with brown background, as appropriate (1 face front is required)

#### EXCEPT

If the charge is traffic related, process as above, but omit the green and white MSP Fingerprint Card only. Unless charged as an adult, juveniles shall not be processed at the Charles County Detention Center.

## 4-624 DISPOSITION OF CHARGES BY THE DEPARTMENT OF JUVENILE SERVICES

The Department of Juvenile Services makes dispositions in numerous cases by reprimand, warning, referred to counseling, informal supervision, etc.

Officers also have the right to appeal dispositions in cases other than those described above. The State's Attorney's Office will review and make the final decision on all appealed cases.



Administrative and Operational Manual

September 12, 2022

Officers shall follow the procedures listed below when receiving a disposition document from The Department of Juvenile Services:

- When a case is a school related drug and/or weapon case, and the disposition is other than court action, sign on the appropriate line at the bottom of the form and forward the entire form to our Records Section;
- Records Management will forward all appeal requests to the State's Attorney's Office;
- If a case is other than a school related drug and/or weapon case and the arresting officer wishes to appeal the disposition, the same procedures as stated above should be followed;
- If satisfied with the disposition and not appealing, simply date and initial the top portion of the disposition form and forward it to the Records Section for filing.

**NOTE:** All Department of Juvenile Services Disposition Forms are to be forwarded to the Records Management Section after review, signing, or initialing.

## 4-625 TEMPORARY DETENTION OF JUVENILES

The purpose of the following policies is to establish procedures relative to the temporary detention of juveniles at Charles County Sheriff's Office facilities while being processed. At a minimum, this policy shall provide for the following:

- determining whether the juvenile is alleged to have engaged in criminal (delinquent offender) or non-criminal (status or non-offender) behavior;
- determining whether the juvenile is alleged to have been harmed or to be in danger of harm;
- notifying parents or guardians that the juvenile has been taken into custody;
- ensuring that the constitutional rights of juveniles are protected;
- ensuring sight and sound separation is provided between juveniles and adults and between males and females placed in temporary holding areas;
- ensuring that status and non-offender juveniles are not detained in secure detention areas and are detained and transported separately from delinquent offenders; and
- ensuring juveniles are released or taken to an intake facility without undue delay.

### 4-625.1 CUSTODY PROCEDURES

The parents or guardians of a juvenile taken into custody shall be notified as soon as possible, preferably upon the juvenile's arrival at a CCSO facility, but in all cases within 48 hours. All attempts at notification will be documented.

When a juvenile is taken into custody for any reason, officers will attempt to determine through observation and interview if the juvenile is alleged to have been a victim of abuse or neglect or may be in danger of harming him or herself. If it is determined the juvenile poses a possible danger to others or to him or herself, a Warning / FIR / Security Risk Form #389 will be completed, unless the person accepting custody is a parent or guardian, in which case they will be verbally notified and the notification will be documented in the incident report or JOR.

As soon as an officer deems it may be necessary to detain a juvenile offender pending a hearing, or to place a

**Administrative and Operational Manual****September 12, 2022**

status or non-offender in a Department of Juvenile Services sponsored facility or foster home, the local Department of Juvenile Services (DJS) Intake Officer must be contacted for authorization.

During processing, or while awaiting release or approval to transport to a juvenile facility, juveniles may, depending on the circumstances, be held unsecured under direct supervision, placed in a temporary detention area or secured to a cuffing rail or similar approved stationary object. Unless sight and sound separation can be strictly maintained while a juvenile is being held or processed in a facility, no adult offender may be brought into that same facility.

Delinquent juvenile offenders shall not be held in a secure area for more than a total of six hours and for no more than 2 hours without continuous control or supervision by Agency personnel. The six-hour period begins when the juvenile is actually placed into a secure area or handcuffed to a stationary device. If unable to transport or release a juvenile offender within the six hours, the juvenile may be handcuffed, placed in a non-secure area and directly supervised by an officer until transported or released. Any violations of the six-hour rule must be thoroughly documented as to the reason and include the names of parents, guardians, relatives, the DJS Intake Officer and DJS supervisors contacted.

Juvenile status offenders or non-offenders (runaways, truants, abused / neglected children) shall not be held for any length of time in secure detention. These juveniles may only be held in unlocked multipurpose areas, such as a lobby, office or interrogation room that is not designated, set aside or used as a secure detention area. Handcuffing techniques that do not involve cuffing rails or other stationary objects are considered non-secure.

In every case where a delinquent offender is placed in temporary detention or handcuffed to a stationary object, the officer handling the case, in addition to following the procedures for using temporary detention areas, shall complete a Juvenile Secure Custody Report Form #40 and submit it with the Juvenile Offense and/or other required reports.

Juveniles, unless waived to adult jurisdiction or arrested as part of the same incident, cannot be detained or transported with adults.

Unless in need of emergency medical treatment, when detention is authorized by a Department of Juvenile Services Intake Officer or the court, the juvenile shall be transported without delay.

#### **4-625.2 REPORTING**

It shall be the responsibility of Records Management to complete and submit the Maryland Juvenile Justice Advisory Council Semi-Annual Report to the appropriate agency.

#### **4-625.3 INTERVIEW AND INTERROGATION OF JUVENILES**

Juveniles have the same rights regarding statements and confessions as adults. Generally, juvenile interviews / interrogations will be conducted in the same manner as adult interviews / interrogations. Juveniles have no explicit rights to have parents / guardians present during questioning. Prior to custodial interrogations, officers will inform juveniles of their Miranda rights. Prior to the conclusion of the interview / interrogation process, officers will explain the Agency's and Department of Juvenile Services procedures concerning the handling of juvenile charges to the juvenile being interrogated. Generally, officers should attempt to answer questions about procedures and the juvenile justice process. Procedures that may need to be explained include, but are not limited to:

- determining factors for detention versus release to a parent or guardian;
- referral of juvenile offenders for formal legal proceedings for those cases involving serious or repeated criminal violations;
- crimes of violence that are reportable to the Superintendent of Schools;
- referral to Teen Court;
- the handling of juvenile records;
- possible disposition of charges by DJS and/or the courts;



Administrative and Operational Manual

September 12, 2022

- 
- reprimand, counseling or informal supervision;
  - community service;
  - victim restitution;
  - formal probation;
  - home detention and monitoring; and
  - placement in a secure residential program.

The officer conducting the interrogation must consider several factors with respect to a juvenile's ability to waive his / her Constitutional rights. These factors include:

- the juvenile's age;
- the juvenile's background, experience, and education;
- the juvenile's apparent level of intelligence; and
- the juvenile's mental and physical condition.

Ordinarily and absent a particular showing, a juvenile age ten or younger will be entitled to the counseling and guidance of a parent or guardian before waiving his / her Constitutional rights.

When considering the duration and number of officers to be involved in the interview / interrogation process, officer(s) shall take into consideration the juvenile's age, the nature of the alleged offense, and the juvenile's mental and physical condition. There will be a maximum of two officers present during the interview / interrogation of juvenile suspects. The duration of the interview / interrogation will be reasonable.

Interviewing officer(s) may confer with the juvenile's parents or guardians before, during or immediately after the interview / interrogation as considered appropriate under the guidelines of this policy.



Administrative and Operational Manual

September 12, 2022

---

## 4-626 JUVENILE DRIVER PARENT NOTIFICATIONS

Noting that alarmingly high numbers of juveniles are injured or killed in motor vehicle collisions annually, recognizing much of this is attributable to inexperience or inappropriate driving behavior and understanding that early parental intervention is critical in correcting this behavior, the Charles County Sheriff's Office is determined to take a proactive approach to this situation.

Any time an officer stops a juvenile driver as a result of a traffic violation, equipment violation or investigates a motor vehicle collision where a juvenile driver is found to be at fault, the juvenile's parent(s) may be notified at the discretion of the officer. This notification will be in addition to the notification that the MVA provides. The Juvenile M/V Violation Notification Form #888 has been developed for this purpose.

For purposes of this policy, the term "juvenile" refers to any person under the age of 18.

### 4-626.1 OFFICER'S RESPONSIBILITIES

If the officer deems it necessary to send a notification to the parents or legal guardian of the juvenile driver, the officer will obtain the name and current mailing address from the juvenile.

In the cases where the juvenile driver refuses to provide this information, no additional enforcement action will be taken as a result of this refusal. In these cases, the notification will be addressed to "The Parent or Guardian of (Driver's Name)" and mailed to the juvenile's current mailing address. This will be the responsibility of the officer.

If it is determined the juvenile driver's parent or guardian is present at the time of the violation or collision, no further notification will be necessary.



## Administrative and Operational Manual

September 12, 2022

## 4-627 REQUESTS FOR ASSISTANCE FROM BAIL BONDSMEN AND BOUNTY HUNTERS - GENERALLY

From time to time, members of the Charles County Sheriff's Office are called upon to assist bail bondsmen, also known as bail agents or bounty hunters. Requests may come in the form of assisting with the apprehension of wanted persons, or taking custody of persons already apprehended by the bondsmen. In either case, it is incumbent upon members of this Agency to conduct themselves within the confines of law and policy.

Bail bondsmen are endowed, by common law, with the authority to seize defendants at any time and in any place in order to discharge their liability for the bond amount. At any time prior to forfeiture of the bond, the bondsman may retake the defendant and return him to custody, which has the effect of releasing the bondsman from his financial responsibility. The U.S. Supreme Court in *Taylor v. Taintor*, 83 U.S. 366, (1872) has determined a bondsman's authority is like that of a sheriff, re-arresting an escaping prisoner; and Maryland courts have held the bondsman has greater authority than a private citizen to effect an arrest, *Shifflett v. State*, 80 Md App 151, (1989). In *Frasher v. State*, 8 Md App 439, (1970), Maryland courts have held that the bondsman may request official help in taking the defendant into custody, or he may do so himself; further, that no further process (warrant) was necessary to authorize arrest by the bondsman.

### 4-627.1 PROVIDING ASSISTANCE - OFFICERS

The Sheriff's role in assisting a bail bondsman is limited to protecting life and the privacy interest of the involved parties. Therefore, before taking custody of a person apprehended by a bail bondsman, or assisting the bondsman with an apprehension, the officer shall verify the existence of an outstanding warrant for the person's arrest. If no warrant can be confirmed, custody should not be accepted, nor should any assistance be provided in making an apprehension.

Prior to assisting a bondsman with transport of a person being taken into custody without a warrant, the officer shall verify the existence of bail paperwork indicating the person is obligated to the bondsman. Under these circumstances, the bondsman is responsible for presenting the person to the District Court Commissioner for commitment in the County in which the case is scheduled to be heard.

In any case, prior to assisting a bondsman in any manner, the officer shall verify and record the identity and authority of the individual by being present with proper proof of identification, and a current bondsman's license or bounty hunter's letter of authorization.

Because of the bondsman's unique authority to seize persons they have bonded at any time in any place, including the authority to break and enter the bonded person's house, officers must never use bondsmen or bounty hunters as agents to extend their own police powers. Officers shall not participate in the breaking of doors to apprehend a wanted individual unless in fresh pursuit or commanded by a valid search and seizure warrant. In other words, officers are bestowed with no greater authority by virtue of their association with a bondsman or bounty hunter, and officers should not utilize the bondsman's unique authority to circumvent due process.



## Administrative and Operational Manual

September 12, 2022

## 4-650 MARYLAND UNIFORM CIVIL CITATIONS

### 4-650.1 GENERAL INFORMATION

The Uniform Municipal Infraction / Civil Citation (Form #DC-28) will be used to charge a person, 18 years of age and over, for adult civil violations. The Uniform Juvenile Civil Citation for Alcohol Offenses (Form #DC-31) will be used to charge a person for juvenile alcohol violations.

- Adults (ages 18 and over) will be charged on Form #DC-28 (for alcoholic beverage offenses only);
- Juvenile (under 18 years of age) alcohol offenses will be recorded on Form #DC-31;
- Each citation shall reflect only one charge;
- Failure to sign the citation does not subject a defendant to arrest;
- Code violations are not criminal violations for which an arrest may be made.

### 4-650.2 REFUSAL TO PROVIDE IDENTIFICATION

Criminal Law, §10-120 provides that failure or refusal to provide proof of identification and age, upon request of an officer issuing a citation, is a misdemeanor. This person may be arrested and processed, even if the violation is for alcohol.

Criminal Law §10-120 does not require that written proof or a government issued identification be provided. If verbal proof appears reasonable, a citation may be issued.

§10-120 only applies to certain alcohol violations:

- Crim. Law §10-113: Misrepresentation of Age
- Crim. Law §10-114: Underage Possession
- Crim. Law §10-115: False Documentation
- Crim. Law §10-116: Obtaining for Underage Consumption
- Crim. Law §10-117: Furnishing/Allowing Underage Consumption
- Crim. Law §10-118: Unregistered Keg
- Education §26-103: Alcohol on Public School Grounds

### 4-650.3 UNIFORM MUNICIPAL INFRACTION / CIVIL CITATION (#DC-28)

The Form #DC-28 is used for adult civil violations, also known as code violations. The following violations may be charged on the Form #DC-28:

#### Alcoholic Beverage Article

§6-321: Public Consumption of Alcohol

§6-322: Open Containers

#### Education Article, § 26-103

- Possession or drinking alcoholic beverage on school property;
- Possession or drinking alcoholic beverage on school property causing a disturbance.

#### Crimes and Punishments





Administrative and Operational Manual

September 12, 2022

Criminal Law § 5-601.1: Citation for possession of less than 10 grams of marijuana.

Criminal Law, § 9-609: Accidentally or negligently activating an alarm system.

Criminal Law, § 9-611: Failure to properly equip audible alarm system.

Criminal Law, § 10-113: False representation of age to obtain alcoholic beverage from licensed dealer.

Criminal Law, § 10-114: Unlawful possession of alcoholic beverage by person under age 21.

Criminal Law, § 10-115: Possession of a card or document that falsely identifies age with intent to obtain, possess or use an alcoholic beverage

Criminal Law, § 10-116: Obtaining alcoholic beverage for consumption by a person under age 21.

Criminal Law, § 10-117: Furnishing alcoholic beverage for consumption by a person under age 21.

Criminal Law, § 10-118: Possession of unregistered keg.

Criminal Law, § 10-107: Distribution of any tobacco product to a minor (including cigarette rolling papers), obtaining any tobacco product for a minor.

**NOTE:** The above list is not all inclusive.

Civil Code violations are not criminal. It is unlawful to arrest a person solely based upon a civil code violation. Failure of the defendant to sign the citation does not subject him / her to arrest. "Refused to Sign" shall be written in the defendant's signature block and the citation issued.

The Form #DC-28 is handled by the District Court. The section on the citation that states "A court date will be sent to you by mail" should be crossed out and the issuing officer's next preliminary hearing date (at least 10 days after the issue date) shall be entered on the citation.

In the "Civil / Code Violations" area, officers must complete the section which indicates the fine amount the courts may impose.

The back of the original copy (white) should be used for recording any witness information.

A statement of probable cause for the issuance of the citation must be written on the back of the green copy. The officer shall date and sign this statement.

#### 4-650.4 POSSESSION OF MARIJUANA - CIVIL OFFENSE

Possession of less than 10 grams of marijuana will be charged on a civil citation (DC-028 for adult and DC-031 for juvenile).

Effective February 20, 2016, smoking marijuana in a public place is now a civil offense punishable by a fine not exceeding \$500. This is in addition to the current civil offense for the possession of less than 10 grams of marijuana. "A public place" includes a vehicle; therefore, unless there is probable cause to believe the driver is impaired (traffic violation), an officer may not stop the vehicle only for the civil violation(s). Once lawfully stopped, the officer can search / arrest if probable cause exists.



Administrative and Operational Manual

September 12, 2022

---

Incidents involving the civil violation of possession of marijuana of less than 10 grams will be handled as follows:

- Civil Marijuana Violations:
  - Marijuana will be collected, photographed, and field tested;
  - An Incident Report number only will be obtained. No Incident Report is required.
  - The I.R. number is to be placed on the Property Held form and Civil Citation;
  - The Marijuana will be documented on a Property Held form and submitted for destruction;
  - Searches will not be conducted incident to civil citation.
  
- Cell phones and non-CDS evidence will not be seized in reference to civil violations of marijuana possession.
- An individual is not mandated to produce identification for a civil citation. In situations where the defendant does not produce identification, take a digital photo. If the individual refuses to permit a photo to be taken, attempt to capture one thru a digital mobile video/audio recorder (DMVR).
- If the individual is pulled over for a traffic stop, there are still provisions related to the traffic violation that require the individual to produce identification.
- In situations where it is not mandatory to produce identification, nothing prohibits officers from simply asking for identification.

An example of Uniform Civil Citation Form #DC-28 is on the next page.



Administrative and Operational Manual

September 12, 2022

UNIFORM CIVIL CITATION

WITNESS
RELATED CASE NO./ CITATION(S)
Related IR number

District Court of Maryland for

Address
County/Municipality/State of Maryland vs. Agency

Defendant's (Last) Name First Middle

Current Street Address Apt. No.

City County State Zip

DOB Height Weight Sex Race Hair Eyes
Telephone No. Day/Night E-mail

Based on personal knowledge of the undersigned officer the attached affidavit, the Defendant is charged with

at Time AM PM on Month / Day / Year

at Location of Offense

County, MD in violation of: Md. Ann. Code Municipal Infraction/County Ordinance/Public Local Law/Local Code COMAR

Document/Article Section Sub Section Paragraph

Each day a violation continues is a separate infraction subject to an additional citation.

I sign my name as a receipt of a copy of this Citation and not as an admission of guilt. I will comply with the requirements set forth in this Citation.
Defendant's Signature

INSTRUCTIONS

YOU MUST APPEAR IN COURT. A notice of trial date will be mailed to you.

YOU MAY PAY A FINE of \$ (entire amount required) by Date to the:

District Court. Payment of the fine will not close the case if abatement action is pending.

Agency/Municipality

at Agency/Municipality

and Agency/Municipality

YOU must appear in court if you do not pay the fine or request a trial date will not be set. your request in writing to the:

District Court

Agency/Municipality

in writing by Date at Address

DO NOT SEND PAYMENT OF FINE. The District Court will mail you a notice of your trial date, time, and location. AT TRIAL the Court may impose a fine up to the maximum allowed by statute plus court costs.

IN ADDITION, Agency/Municipality is seeking abatement of this infraction.

You may be ordered to abate this infraction or be assessed the costs for the abatement, as well as a fine of up to \$1,000, plus court costs. Payment of the preset fine will not satisfy the abatement action and an order of abatement may still be entered against you.

- FAILING TO APPEAR OR PAY THE FINE MAY RESULT IN A WARRANT BEING ISSUED FOR YOUR ARREST.
FAILING TO PAY THE FINE OR REQUEST A TRIAL DATE: will deem you liable for the fine assessed; the fine may be doubled and/or a judgment on affidavit may be entered against you including an order of abatement.
FAILURE TO APPEAR FOR A REQUESTED TRIAL DATE: the fine may be doubled and a judgment on affidavit entered against you.

I solemnly affirm under the penalties of perjury, and based upon personal knowledge or the attached affidavit, that the contents of this citation are true and that I am competent to testify on these matters.

The Defendant is not now in the military service, as defined in the Servicemembers Civil Relief Act.

Issuing Officer's Signature Officer's Printed Name Date

Agency Sub-Agency I.D. No. Telephone

Front of Citation:

- Copy #1: Municipality/Court Copy
Copy #2: Prosecutor's Copy
Copy #3: Defendant's Copy
Copy #4: Municipality's Copy
Copy #5: Officer's Copy

Reverse of Citation:

- Copy #1: Witness List
Copy #2: (Blank)
Copy #3: Notice
Copy #4: (Blank)
Copy #5: Officer's Notes

If person refuses, write Refused to Sign.

1st offense - \$50.00
2nd offense - \$125.00
Due 30 days from the date of offense.

3rd offense and any offense for 18, 19, 20 year olds will be checked Must Appear.

Any Maryland District Court. If mail, send to 11 Washington Ave, La Plata, MD 20646



Administrative and Operational Manual

September 12, 2022

In simple possession / use situations where the amount appears close to 10 grams:

- Detain the individual until the marijuana can be weighed. If the officer subsequently determines that the amount is less than 10 grams, issue the civil citation and release the individual;
- Follow all procedures listed above for a civil infraction (less than 10 grams);

Where the marijuana is clearly over 10 grams, the law remains unchanged.

In special situations where PWID is suspected, and the amount of marijuana is less than or close to 10 grams, the evidence will be collected, documented, and processed so the individual may be charged via application for statement of charges.

Found CDS or CDS recovered from someone in a non-criminal manner:

- CDS will be collected, photographed, and field tested;
- An Offense / Incident report number will be obtained, and documented on the Property Held form and submitted for destruction.

Multiple Offenses - Criminal and Civil:

In cases where there is a criminal violation as well as a civil violation for marijuana possession, charge the criminal violation but do not charge the civil citation for marijuana. This applies to all criminal violations; for example, if there is a robbery suspect in possession of marijuana, charge the robbery but not the civil citation for marijuana. The marijuana will be collected, for either destruction or as evidence in support of the criminal violation.

Possession of drug paraphernalia involving the use or possession of marijuana is no longer a crime, effective February 20, 2016.

**4-650.5 UNIFORM JUVENILE CIVIL CITATION FOR ALCOHOL OFFENSES FORM #DC-31**

The Form #DC-31 is used for juvenile civil violations, also known as code violations. The following violations may be charged on Form #DC-31:

Alcoholic Beverage Article

§6-321: Public Consumption of Alcohol

§6-322: Open Containers

Education Article, § 26-103

- Possession or drinking alcoholic beverage on school property;
- Possession or drinking alcoholic beverage on school property causing a disturbance.

Crimes and Punishments, Criminal Law

Criminal Law, § 10-113: False representation of age to acquire alcoholic beverage from licensed dealer.

Criminal Law, § 10-114: Unlawful possession of alcoholic beverage by person under age 21.



Administrative and Operational Manual

September 12, 2022

Criminal Law, § 10-115: Possession of a card or document that falsely identifies age with intent to obtain, possess or use an alcoholic beverage.

Criminal Law, § 10-118: Possession of unregistered keg.

Juvenile civil violations are not criminal violations. It is unlawful to arrest a person solely based upon a civil code violation. Failure of the defendant to sign the citation does not subject him / her to arrest. "Refused to Sign" shall be written in the defendant's signature block and the citation issued.

Officers shall record witness information and complete a statement of probable cause on the back of the original citation page. The officer shall sign and date this statement.

Officers shall attempt to contact the juvenile's parent to respond, to take custody of the juvenile, and to sign the citation. When contacting a parent by phone, officers shall verify the juvenile's address. If a juvenile's parent cannot respond to the scene to sign and receive the parent's copy of Form #DC-31, the issuing officer shall send the copy by mail.

Juvenile civil violations are handled by the Department of Juvenile Services. That agency will notify the parents of the juvenile of a hearing date.

#### 4-651 MARYLAND UNIFORM CRIMINAL CITATION FORM #DC/CR-45

The Maryland Uniform Criminal Citation Form #DC/CR-45 is used for charging adults (18 years of age and older) with certain offenses as described in this policy. A Criminal Citation may be issued only to adults who reside in the State of Maryland. Only one charge is permitted per each #DC/CR-45.

An update concerning the use of the Uniform Criminal Citation was passed by the Maryland General Assembly in 2012 and became effective January 1, 2013. A portion of the law mandates, with certain exceptions, that a law enforcement officer charge a defendant by a Uniform Criminal Citation for certain criminal offenses in lieu of a statement of charges. The law also authorizes a law enforcement officer, who has grounds to make a warrantless arrest, to make a custodial arrest and process a defendant prior to release upon his or her signature on a criminal citation.

Subject to the exceptions described below, an officer who has grounds to make an arrest for an offense for which the maximum penalty of imprisonment is 90 days or less, shall generally make the arrest, search incident to arrest, issue a citation, and release the person.

When a Criminal Citation is issued and a physical arrest not made, it is not mandatory to obtain fingerprints; however, photographs will be taken in all cases, using the officer's issued camera. Photographs of individuals which are taken upon #DC/CR-45 issuance can be taken at the local district station or at a location with an unobstructed background.

An officer shall not detain any person based upon race, color, ethnicity, national origin, gender, age, sexual orientation, disability or genetic information. An officer shall not participate in the use of any unlawful discriminatory characteristic as a cause for taking any law enforcement action against any individual or group of individuals.

For information concerning other warrantless arrest criteria not involving the issuance of a citation, refer to section 4-600.2 of this Manual.



## Administrative and Operational Manual

September 12, 2022

### 4-651.1 CRITERIA FOR ISSUING CITATION

A defendant must meet certain criteria to be released without approval by a court commissioner. If the defendant cannot meet the criteria listed below, the officer must charge the individual on a statement of charges and ensure the defendant's appearance before a court commissioner. Additionally, when charging such offenses on a statement of charges instead of a criminal citation, it is mandatory that the officer's specific reasons for not releasing the defendant be written into the statement of charges. A law enforcement officer may charge a defendant by citation only if:

- the officer is satisfied with the defendant's evidence of identity;
- the officer reasonably believes that the defendant will comply with the citation;
- the officer reasonably believes that the failure to charge on a statement of charges will not pose a threat to public safety;
- the defendant is not subject to arrest for an alleged misdemeanor involving serious injury or an alleged felony, arising out of the same incident or based on an outstanding arrest warrant; and
- the defendant complies with all lawful orders by the officer and must sign the citation.

### 4-651.2 OFFENSES REQUIRING CITATIONS

Subject to the requirements of 4-651.1, an officer shall issue a citation for:

- Any misdemeanor or local ordinance violation that does not carry a penalty of imprisonment;
- Any other misdemeanor or local ordinance violation not involving serious injury or immediate health risk for which the maximum penalty of imprisonment is 90 days or less;
- Criminal possession of marijuana under § 5-601 of the Criminal Law Article;
- Malicious destruction of property under \$1000;
- Theft with a value over \$100, but under \$1,500; and
- Sales of alcohol to a minor or intoxicated person.

### 4-651.3 OFFENSES FOR DISCRETIONARY CITATIONS

Subject to the requirements of 4-651.1, an officer may issue a citation for:

- Sale of an alcoholic beverage to an underage drinker or intoxicated person under § 6-304, § 6-307, § 6-308, or § 6-309 of the Alcoholic Beverages.
- Malicious destruction of property under § 6-301 of the Criminal Law Article, if the amount of damage to the property is less than \$500.



## Administrative and Operational Manual

September 12, 2022

- Misdemeanor theft under § 7–104(g)(2) of the Criminal Law Article (theft under \$1500).
- Possession of a controlled dangerous substance other than marijuana under § 5–601 of the criminal law article.

#### 4-651.4 EXCEPTIONS - OFFENSES THAT CANNOT BE CHARGED BY CITATION

- Failure to comply with a peace order under § 3–1508 of the Courts Article;
- Failure to comply with a protective order under § 4–509 of the Family Law Article;
- A violation of a condition of pretrial or post-trial release under § 5–213.1 of the Criminal Procedure Article;
- Possession of an electronic control device after conviction of a drug felony or crime of violence under § 4–109(b) of the Criminal Law Article;
- Violation of an out-of-state domestic violence order under § 4–508.1 of the Family Law Article;
- Abuse or neglect of an animal under §10–604 of the Criminal Law Article;

#### 4-651.5 REQUIRED FORMS AND REPORTS

##### Uniform Criminal Citation

The officer shall use the Uniform Criminal Citation Form #DC/CR-45 to charge a defendant by citation. The officer shall use either:

- the pre-printed / pre-numbered book provided by the District Court; or
- in the case of an electronic format, the assigned electronic citation number provided by the District Court.

##### Probable Cause Continuation Sheet Form #DC/CR-45

Under no circumstances should the officer try to write the entire probable cause statement on the first page of the Uniform Criminal Citation. The officer shall use the statement of probable cause continuation sheet to complete the probable cause narrative outlining the facts and circumstances substantiating the charge. The Uniform Criminal Citation number shall be recorded in the case number block on the continuation sheet.

##### Criminal Investigation Report and/or Incident Report

In addition to the Uniform Criminal Citation and the probable cause continuation sheet(s), the law enforcement officer shall complete an Incident Report detailing the circumstances of the incident and the arrest report as required by Agency policy. A copy of the report shall be forwarded to the State's Attorney's Office with a copy of the citation by the Records Management Section.

When a law enforcement officer determines that a Uniform Criminal Citation shall be the form by which to charge a defendant, the officer shall use the preprinted / pre-numbered book provided by the District Court or the assigned electronic citation number provided by the District Court. The names and addresses of the Victims and Witnesses are not to be listed on the citation or continuation sheet. In every case, copies of the Uniform Criminal Citation and continuation sheet(s), if applicable, shall be given to the defendant upon their release. Copies of the Citation, Continuation Sheet, and Criminal Investigation / Incident Report shall be submitted to a supervisor for review and approval. Additionally, a copy of all citations and related reports shall



---

be submitted through the chain of command to the State's Attorney's Office

#### Top Charges – Not All Inclusive

### 4-651.6 ADDITIONAL CRIMINAL CHARGES

When an officer conducts a search of an individual being given a criminal citation and develops Probable Cause for an arrestable offence, he must make a full custody arrest and charge all the offenses including the original one on a Statement of Charges. In these cases, standard arrest procedures and the use of associated documents will be followed.





## Administrative and Operational Manual

September 12, 2022

**4-651.7 LAW ENFORCEMENT REPORTING - STATISTICAL DATA COLLECTION**

Beginning January 1, 2013, law enforcement agencies are required to collect the following data on all criminal citations issued:

CJIS Code	Statute 1	Statute 2	Statute 3	Statute 4	Charge Description	Type of Charge	Penalty	Fine
1 1564	CR	5	601	(a)(1)	POSS: Marijuana 10 GM+	MISDEMEANOR	6 MONTHS	1000
2 0060	CR	10	201	(c)(4)	DISTURB THE PEACE	MISDEMEANOR	60 DAYS	500
1 0521	CR	7	104		THEFT LESS THAN \$100.00	MISDEMEANOR	90 DAYS	500
1 1137	CR	7	104		THEFT: \$100 TO UNDER \$1,500	MISDEMEANOR	6 MONTHS	500
2 2210	CR	6	402		TRESPASS-POSTED PROPERTY	MISDEMEANOR	90 DAYS	500
3 4025	CR	6	301		MAL DEST PROP/VALU - \$1,000	MISDEMEANOR	60 DAYS	500
1 1476	CP	5	212		FAIL APPEAR-CITATION	MISDEMEANOR	90 DAYS	500
1 1661	AB	6	320	(a)(1)	ALC. BEV./INTOXICATED ENDANGER	MISDEMEANOR	90 DAYS	100
1 0191	CR	3	803		HARASS; A COURSE OF CONDUCT	MISDEMEANOR	90 DAYS	500
1 0640	CR	10	110	(c)	LITTER/DUMP UNDER 100 LBS	MISDEMEANOR	30 DAYS	1500
1 1662	AB	6	320	(a)(2)	INTOXICATED PUBLIC DISTURBANCE	MISDEMEANOR	90 DAYS	100
1 0005	FL	5	801		CONFINED UNATTENDED CHILD	MISDEMEANOR	30 DAYS	500
1 1143	CR	8	103	(b)	BAD CHECK/STOP PAY/LESS THAN \$100	MISDEMEANOR	90 DAYS	500
1 0581	CR	8	206	(a)(1)	CRDT CRD/ANTHR CHG L/T \$100	MISDEMEANOR	90 DAYS	500
1 0928	ED	7	301		SCHOOL:FAIL SEND CHILD	MISDEMEANOR	3 DAYS	50
2 005	CR	10	201	(c)(3)	FAIL OBEY RENBLE/LAWFL	MISDEMEANOR	60 DAYS	500

- The date, location, and time of the issuance of the citation;
- The offense charged;
- The gender of the offender;
- The date of birth of the offender;
- The state and, if available, the county of residence of the offender; and
- The race or ethnicity of the offender as:
  - Asian;
  - Black;
  - Hispanic;
  - White; or
  - Other.

ITD shall be responsible for the collection and submission of this data to the state. This data will be stored by MSP who will submit citation data for all law enforcement agencies in the state to the Maryland Statistical Analysis Center (MSAC) by March 1 each subsequent year.







## Administrative and Operational Manual

September 12, 2022

**4-660 PROCESSING AND TEMPORARY DETENTION AREAS**

Officers often need to temporarily detain persons as part of the arrest and booking process or before booking them into CCDC. Daily operations are often unpredictable, and it may be necessary to use a room, space, or area in a law enforcement facility to separate persons under arrest, maintain control, complete reports and forms, conduct interviews and perform tests.

Temporary detention of persons legally held in custody by sworn officers of the Agency will conform to the criteria set forth in this policy. Persons will not be detained, except for temporary periods as defined in this policy. Only designated specific room(s) and area(s) within Agency facilities are authorized for use for temporary detention.

The person being temporarily detained will be constantly observed in person or by video monitor. A face-to-face visual observation of detainees will be conducted at least every thirty minutes. All detained persons will be segregated by sex, and juveniles will be separated by sight and sound from adults.

All facilities designated as temporary detention areas will be inspected prior to and after their use to check for possible contraband and to ensure their suitability for the intended use. The area will be inspected for contraband, safety, and proper function. The results of the inspection will be documented on the Temporary Detention Log Form #40. Additionally, the commander in charge of the facility where a detention area is located will assign someone to conduct a weekly inspection to check the area for cleanliness and to determine if any unsafe conditions exist. The person conducting the inspection shall use the Weekly Temporary Detention Area Inspection Form #836.

Generally, with the possible exception of a defense attorney or parent(s) of a young child, visitors should not be allowed into temporary detention areas. The first consideration for allowing a visitor in a temporary detention area shall be security. Officers shall have discretion as to when a visitor is or is not allowed access. Visitor access will be documented on the Temporary Detention Log.

The use of a temporary detention area will be documented in a log kept for this purpose. The log will contain the:

- location of the temporary detention;
- name of the person detained;
- name and ID number of the officer placing the person in temporary detention;
- time and date the person is placed in temporary detention;
- reason the person is being placed in temporary detention;
- name(s) and purpose of any visitors allowed;
- time and date the person is released from temporary detention;
- reason the person is released from temporary detention;
- destination of the person after his release; and
- any special information or conditions related to the person while in temporary detention.

The officer placing a person in temporary detention is responsible for the person during the period the person is in temporary detention. If the original officer placing a person in temporary detention is relieved of this responsibility by a superior officer, this information will be documented in the log, including the date and time relieved, who is assuming the responsibility for the person in temporary detention and the name, rank and ID number of the supervisory officer authorizing this action.

Persons temporarily held will be provided the opportunity to use restroom facilities and be provided drinking water and other such personal needs as may be required. If the temporary detention area is used, a person may not be held without continuous control and supervision by Agency personnel for more than two (2) hours. Continuous control and supervision necessitates constant observation of the detainee.

Persons held in temporary detention areas may be secured to anchor devices, such as a bar or ring which have been specifically designed for this purpose. They will not be secured to chairs, desks or other objects not designed

**Administrative and Operational Manual****September 12, 2022**

for temporary detention.

All persons held in temporary detention areas will be immediately evacuated to the Charles County Detention Center in the event of fire or other emergency within the facility containing the temporary detention area. No person will be held in a temporary detention area unless fire suppression equipment and an emergency evacuation plan is in place for the temporary detention area. Likewise, such areas will not be used unless they are kept free of any materials which might aid in the creation of a fire or which might fuel its continuation.

**4-660.1 TRAINING OF PERSONNEL**

Temporary detention occurring outside the confines of a holding facility such as a jail or other more secure correctional institution can involve close contact with detainees under challenging and sometimes less than ideal conditions. Therefore, personnel who utilize or monitor temporary detention areas will read and be familiar with Section 4-600 of the AOM.

Additionally, to help reduce complacency, the Agency will provide training on the use of temporary detention to all personnel responsible for monitoring temporarily detained individuals. Officers receive initial training on prisoner processing and security while attending the Academy. The Police Station Technician supervisor will ensure that any newly hired Police Station Technicians complete the initial training before being allowed to monitor detainees. Refresher training on this subject will also be provided for officers, police station technicians and any other required personnel at a minimum of once every four (4) years.

**4-660.2 WEAPONS CONTROL**

No person may be brought into or secured within a temporary detention area unless there is provided a weapons lockbox for the storage of employee weapons while they are managing persons in custody. All weapons will be secured prior to handcuffs being removed from persons in custody. No employee or other person will enter a temporary detention area while wearing a weapon.

**4-660.3 OBSERVATION AND CONTROL OF DETAINED PERSONS**

No prisoner will be brought into a temporary detention area unless the area is monitored by an employee other than the employee handling the prisoner. No prisoner will be unhandcuffed in an Agency facility, except the Charles County Detention Center, unless there are at least two employees to handle the prisoner, or there is an employee at a remote observation site. No person other than an employee authorized to handle or deal with prisoners will be permitted to enter a holding area at any time it is occupied by a prisoner.

The officer placing a person in a temporary detention area will be mindful of the possibility of escape. The custody officer shall take precautions to prevent the escape of the detainee. Escape prevention techniques include:

- thorough searches;
- monitoring; and
- proper prisoner handling.

In the event there is an escape from a temporary detention area, the custody officer shall immediately notify all Agency personnel in that facility and follow the guidelines set forth in 4-618 of this Manual.

**4-660.4 SEARCH OF PERSONS TO BE PLACED IN TEMPORARY DETENTION AREAS**

In addition to any search requirements found elsewhere in this Manual, the following additional requirements apply



**Administrative and Operational Manual**

**September 12, 2022**

---

to placing persons in temporary detention areas. All persons prior to being placed in a temporary detention area will be searched for weapons, contraband, evidence, possible implements of escape and objects or clothing items which might be used for self-harm or unlawful purpose. This search will be conducted by at least two employees or an employee who is being monitored from a remote location. The search will be to a degree which assures items are not missed and may involve the removal of clothing items. If clothing items are removed, the policy concerning sexually invasive searches found elsewhere in this chapter will be followed.

**4-660.5 REQUESTING ASSISTANCE IN TEMPORARY DETENTION AREA**

In the event of an emergency, or the need for assistance arises within a temporary detention area, the custody officer shall immediately notify the monitoring employee of the need. The monitoring employee will then notify the Communications Center of the situation and make a request for additional assistance as needed.

**4-660.6 ADMINISTRATIVE REVIEW**

The commander in charge of the facility where a temporary detention area is located shall conduct a written administrative review of policies and procedures governing those areas annually during the month of October. The review shall also include whether the area currently being used is adequate for the Agency's needs and any recommendation for changes or improvements. The review shall be forwarded through the chain of command to the Sheriff. Copies will be provided to all affected members of the Executive Command Staff.



## Administrative and Operational Manual

September 12, 2022

## 4-670 SEARCH AND SEIZURE

### 4-670.1 SEARCH AND SEIZURE WITHOUT A WARRANT

The following general guidelines and procedures are provided for officers to use in conducting searches that have not been reviewed and authorized by judicial personnel. The Supreme Court has ruled the Fourth Amendment of the U.S. Constitution allows police officers to conduct warrantless searches under certain limited circumstances.

The true test of any warrantless search is the demonstration that probable cause existed to justify the search. Officers should rely on their training and experience in conducting searches that meet the legal requirements for evidence to be admissible in court.

### 4-670.2 SEARCH INCIDENT TO ARREST

A warrantless search incident to arrest allows for a complete search of the arrestee and the area within the arrestee's immediate control, for the purpose of locating weapons, means of escape, and evidence of a crime. Also included within the scope of this search is the authority to search containers or other items of personal property within the arrestee's immediate control. This area is generally referred to as the "lunge" area. The search of the lunge area is permitted even when the defendant is in handcuffs or otherwise restricted.

### 4-670.3 CONSENT SEARCHES

There are situations in which officers may deem a consent search to be appropriate. When considering the admissibility of evidence obtained by consent, the officer should take into account and the courts will also take into account:

- whether the person consenting to the search has legal standing to do so; and
- whether the consent was given freely, voluntarily, and with the understanding the person had the right to refuse to consent.

### 4-670.4 STOP AND FRISK

When an officer has knowledge or information sufficient to justify a reasonable fear that a person stopped is presently armed and dangerous, the person may be "frisked."

The officer must be able to articulate the reasons for conducting the frisk. The frisk must be limited to a pat-down of the outside of a subject's clothing solely to determine if he is carrying a weapon. If the officer feels an object believed to be a weapon, a search in and under the subject's clothing may be conducted. Any illegal weapons found as a result of this search may be used as evidence in court.

If the frisk fails to detect a weapon or suspected weapon, the officer must cease and desist from any further search of the subject or his clothing. Items found as the result of a more extensive search could be inadmissible as evidence.

Anytime a frisk for weapons is conducted, a FIR #389 shall be completed. The category "Stop and Frisk" must be checked and the form must be submitted within 24 hours of the frisk.



## Administrative and Operational Manual

September 12, 2022

**4-670.5 VEHICLE SEARCHES**

The Supreme Court has ruled the mobility of vehicles provides an exigent circumstance, wherein warrantless vehicle searches are justified, if probable cause exists to believe that a vehicle contains evidence or contraband. Police officers who have legitimately stopped an automobile and who have probable cause to believe contraband is concealed somewhere within it may conduct a warrantless search of the vehicle that is as thorough as a judicial officer could authorize by warrant.

Where police officers have probable cause to search an entire vehicle, they may conduct a warrantless search of every part of the vehicle and its contents, including all containers and packages that may conceal the object of the search. The scope of the search is not defined by the nature of the container in which the contraband is hidden. Rather, it is defined by the object of the search and the places in which there is probable cause to believe it may be found.

Probable cause that justifies making an arrest of a vehicle's occupant is also generally sufficient for authorizing a search based on exigency. A search incident to arrest is legal where:

- It is reasonable to believe the arrestee might access the vehicle at the time of the search;
- It is reasonable to believe the vehicle contains evidence of the offense of arrest.

When one of these conditions applies, a warrantless search of a vehicle's entire passenger compartment may be made to include containers in the compartment, as a search incident to an arrest, for protection of the officer and/or to prevent the removal or destruction of evidence.

A vehicle may be searched at the scene of a crime if probable cause exists that the vehicle is related to the crime and is believed to contain evidence.

**4-670.6 CRIME SCENE SEARCHES**

Actions taken at the outset of an investigation at a crime scene can play a critical role in the resolution of a case. Carefully approaching, identifying, and securing a crime scene, within the confines of legal considerations, is key to ensuring potential evidence is not tainted.

For the search of a crime scene to be valid, it must fall within one of the narrowly allowed exceptions to the search warrant requirement of the 4th Amendment to the U.S. Constitution.

The "plain view doctrine" provides that if an officer is legally present at a location, then any contraband and/or evidence that is clearly visible to that officer may be seized.

Additionally, entry to and any subsequent warrantless search of a premises is permitted, under an emergency / exigency exception, where there exists a reasonable belief that public safety is in imminent danger, that there is an immediate need to protect or preserve life, or there is an immediate need to locate victims or suspects.

Any search outside of the immediate confines of an identified crime scene may be closely reviewed by the courts. Generally, in situations other than those indicated above, and where there is sufficient time and opportunity, a search warrant should be used.

**4-672 SEARCH AND SEIZURE - SEARCH WARRANTS**

Searches conducted without a warrant are presumed to be unreasonable, and the burden is on the state (and, therefore, the officer) to prove the search was conducted lawfully. On the other hand, searches conducted pursuant





## Administrative and Operational Manual

September 12, 2022

to a search warrant are presumed to be reasonable and the burden is on the defendant to prove the search was unlawful.

#### 4-672.1 SEARCH WARRANTS

A search warrant is a document signed by an authorized judicial officer based upon probable cause presented by an affiant officer. The warrant authorizes the officer to conduct a search for specific items considered to be evidence, tools or fruits of a crime. Search warrants must be served within 10 days of the date of issue. Once served, the warrant must be returned, within 10 days, to the issuing official with a description of what was seized, if anything.

All search warrant applications must reflect:

- the facts known to the affiant;
- the basis of the probable cause to believe there is property subject to seizure at a given location;
- a description of the items to be seized; and
- a detailed description of the place to be searched.

#### 4-672.2 SEARCH WARRANT APPLICATION / SERVICE PROCEDURES

The Affidavit in Support of Application for the Warrant shall state that the affiant is a duly sworn law enforcement officer.

The warrant shall be issued to: Troy D. Berry, Sheriff of Charles County, Maryland, or any duly sworn law enforcement officer under his authority.

Any officer, regardless of assignment, must review any search warrant application with a CID supervisor prior to review and approval by the State's Attorney's Office. Approved warrants will be presented to a judicial officer. In the event the search warrant is for any member of the State's Attorney's Office, it will be reviewed and approved by a Circuit Court or District Court judge after CID review.

Once the warrant is endorsed by a judicial officer, and the assistance of the Emergency Services Team or the Forensic Science Section is anticipated, their respective commander(s) should be notified of the pending search warrant, along with a probable date of execution.

Once a date and time of service is set, the affiant will immediately notify his supervisor / commander and all other units / persons needed to assist in the execution of the warrant. The affiant or his supervisor will act as the Officer in Charge (OIC) and will name a predetermined meeting location, where an execution plan will be prepared and respective assignments designated.

The application and execution of search warrants must comply with the requirements of Maryland and constitutional law, including Maryland Code, Crim. Pro. §1-203.

While executing a search warrant, all officers shall be clearly recognizable and identifiable as police officers. This shall include the wearing of a uniform which displays a badge and the name and identification number of the officer. The uniform for officers assigned to specialized sections – where a standard uniform is not generally worn and who participate in the execution of a search warrant – shall be the wearing of an outer ballistic vest carrier which displays the word SHERIFF or POLICE, the officer's name and the officer's Agency-issued identification number. The officer's badge shall also be displayed and clearly visible.

Nothing in this policy shall preclude an officer from wearing a standard Agency-issued police uniform during a



Administrative and Operational Manual

September 12, 2022

search warrant, no matter the officer's assignment, as long as the officer's name, ID number and Agency badge are clearly displayed.

All search warrants obtained for occupied structures must have an Operational Plan, Form #865, completed and forwarded to the Commander, Field Operations Section or designee as soon as possible prior to service. The Commander will determine if the Emergency Services Team (EST) will be utilized to execute the search warrant based on the information contained in the Operational Plan and will notify the requesting supervisor.

On the date of service, the district commander of the district where the warrant will be served, and the shift commander, shall be notified by the affiant of the search warrant and the area where it will be served.

On arrival at the target location, all members will immediately position themselves at their pre-assigned locations and await further direction. The OIC will then notify Communications of the warrant service and the location.

If utilized, the Emergency Services Team, under the direction of its commander, will make the entry and secure the scene, including all persons found within the premises. Members of the Emergency Services Team will stand by at the scene and assist with security of the premises and any occupants. Flashbang, stun, distraction, or other similar military-style devices may not be used when executing a search warrant, absent exigent circumstances.

Unless executing a "no-knock" search warrant, officers shall allow a minimum of 20 seconds for the occupants to respond and open the door prior to attempting to make entry, unless exigent circumstances exist.

If a "no-knock" search warrant was obtained, after getting written approval from a CID supervisor and the State's Attorney, it shall only be executed between the hours of 0800 and 1900, absent exigent circumstances.

When the scene is secure, the Search Team will then enter and execute the warrant. The Forensic Science Section member will photograph the point of entry, all seized property, and any damages to the premises.

Prior to leaving the building, the OIC will leave a copy of the Search Warrant and a completed Return at the location.

Before securing from duty, the OIC will submit to his supervisor / commander a copy of:

- a proposed press release if appropriate; and
- a Crime Report or Commanders' Information Report, if appropriate.

Within 10 days of the warrant service, the warrant return and copy of the inventory of property will be returned by the affiant to the issuing judicial officer, or if not available, any other judicial officer.

At the conclusion of the search warrant, the unit supervisor will ensure that information about the search warrant is added to the Search Warrant Log. The Commander of the Criminal Investigations Division or his designee is responsible for ensuring that search warrant data is communicated to the Governor's Office of Crime Prevention.



## Administrative and Operational Manual

September 12, 2022

**4-680 VICTIM/ WITNESS ASSISTANCE**

Victim / witness assistance is an integral part of sound law enforcement practices. The role of the Charles County Sheriff's Office is to ensure victims and other witnesses receive professional handling consistent with their important part in the criminal justice process. Agency personnel, from call takers, to the first officer on the scene, to the detective assigned the case and those assigned to the Victim Services Function, must make every reasonable effort to ensure the personal rights and the safety of victims and witnesses are protected. Personnel should be especially sensitive to the special needs of the victims and families of violent crimes such as homicides, domestic violence, child abuse, sexual assaults and elderly abuse.

**4-680.1 RIGHTS OF VICTIMS AND WITNESSES**

The rights of victims and witnesses are outlined in the Maryland Constitution, Maryland Code, and summarized in the Crime Victims and Witnesses Pamphlet. The Criminal Justice Handbook containing the Maryland Code is issued to each officer; and pamphlets are stocked and available at each district station and from Victim Services. Victim / witness assistance information is also available on the State of Maryland's web site. Officers are to keep a supply of the pamphlets on-hand to give out to victims and witnesses. Officers shall record their name, identification number, incident number and a phone number on the front of each pamphlet issued. The pamphlet lists the Agency phone number and other phone numbers where assistance and information is available twenty-four hours a day.

It should be noted other agencies, such as the State's Attorney's Office, State Board of Victim Services, and other social service providers all offer assistance to victims / witnesses, sometimes in conjunction with and sometimes separate and apart from, the CCSO. The following guidelines, excerpted from the Maryland Code, outline law enforcement's role in providing services to victims / witnesses:

- A victim of a crime, victim's representative, or witness:
- should be treated with dignity, respect, courtesy, and sensitivity;
- should receive crisis intervention help, if needed, or be told where crisis intervention help, emergency medical treatment, creditor intercession services, or other social services and counseling may be obtained;
- should be told of the protection available, and, on request, be protected by a criminal justice unit, to the extent reasonable, practicable, and, in the unit's discretion, necessary, from harm or threats of harm arising out of the crime victim's or witness's cooperation with law enforcement and prosecution efforts;
- should, during each phase of the investigative or court proceedings, be provided, to the extent practicable, with a waiting area that is separate from a suspect and the family and friends of a suspect;
- should be told of financial assistance, criminal injuries compensation, and any other social services available to the victim of a crime or victim's representative and receive help or information on how to apply for services;
- on written request, should be kept reasonably informed by a criminal justice unit or the State's Attorney of the arrest of a suspect and closing of the case, and should be told which office to contact for information about the case; and
- should have stolen or other property promptly returned and, on written request, should have the property promptly returned by a law enforcement unit when evidentiary requirements for prosecution can be satisfied by other means, unless there is a compelling law enforcement reason for keeping it.



Administrative and Operational Manual

September 12, 2022

With respect to protecting the identity of crime victims and witnesses, information to be excluded from press releases and held confidential shall include:

- the name, address and telephone number of witnesses or victims of crimes; and
- the names of accused child abusers when identifying the accused would likely identify the victim(s).

Victims / witnesses with communication disabilities are entitled to the same range of police services as those who do not have disabilities. It is the intent of the Charles County Sheriff's Office to provide a qualified interpreter, upon request, to any person who is deaf or hard of hearing.

Upon request, a victim of a crime will be provided a private room to report information related to a crime.

#### 4-680.2 VICTIM/ WITNESS ASSISTANCE DURING PRELIMINARY INVESTIGATIONS

During a preliminary investigation, the investigating officer will ensure appropriate assistance and information is provided to victims / witnesses. As required by the circumstances, victims / witnesses will be provided with the Crime Victims and Witnesses pamphlet which describes available assistance and outlines the criminal justice process. The pamphlet provides the following:

- the case number assigned to the incident (provided by the officer);
- the telephone number for the victim / witness to call to report additional information or receive case updates and status (open, suspended or closed);
- information about applicable services (i.e., counseling, medical attention, compensation programs or emergency financial assistance, and victim advocacy); and
- steps to follow in the event the suspect, or those acting on the suspect's behalf, threaten or otherwise intimidate the victim / witness.

For cases involving violent crimes such as: homicides, serious assaults, domestic violence, child abuse, sexual assaults and elderly abuse, immediate additional assistance may be requested and will normally be provided by CID, Victim Services and other agencies.

#### 4-680.3 VICTIM / WITNESS ASSISTANCE DURING FOLLOW-UP INVESTIGATIONS

For every case where a follow-up investigation is warranted, the following victim / witness assistance services are to be provided by the investigating officer and/or Victim Services:

- re-contact the victim periodically to update them on the status of their case;
- explain to victims the procedures involved in the prosecution of their case and their role in those proceedings;
- if feasible, schedule line-ups, interviews and other required appearances at the convenience of the victim and, at the option of the investigating officer, provide transportation;
- in accordance with all applicable policies and when otherwise possible, promptly return victim property taken as evidence (except for contraband, disputed property and weapons used in the course of the crime), where permitted by law, rules of evidence, or approved by the Office of the State's Attorney;
- provide information about when an arrest is made, charges placed, custody status and how to track offender information through the State's VINE program; and



**Administrative and Operational Manual**

**September 12, 2022**

- Victim Services will monitor follow-up by providing victims with the opportunity to respond to a survey about their experience. Survey results will be used to evaluate and improve the delivery of services.

#### **4-680.4 VICTIM SERVICES COORDINATOR**

The Coordinator of the Victim Services Function is responsible for ensuring the following tasks are performed as designated:

- assist the Commander, Property Crimes Section in defining the Victim Services Function goals and objectives on a fiscal year basis in conjunction with the development of Agency goals;
- maintain liaison with other criminal justice agencies, governmental and non-governmental agencies and organizations concerned with victim / witness needs and rights;
- coordinate efforts with the MRO to periodically inform the public and the media about the Agency's victim assistance services;
- ensure the Agency, and particularly the Communications Section and district stations, are provided with up-to-date materials regarding victim / witness assistance and referral information; and
- complete a documented review of victim / witness assistance needs and available services within Charles County at least once every two years. The review will include:
  - overview of the data compiled from victim / witness surveys;
  - the major types of victimization within Charles County;
  - listing of victim assistance and related community services available within Charles County;
  - number and type of incidents in which Victim Services provided assistance; and
  - identification of all unfulfilled needs of victims and proposals to address those needs which are realistic and within the resources available to the Agency.

#### **4-680.5 REQUESTS FOR CERTIFICATIONS OF VICTIM HELPFULNESS**

A U-Visa certification form is used by a non-citizen to petition for a change in immigration status if the non-citizen is a victim of qualifying criminal activity.

Any and all requests for U Nonimmigrant Status such as a request for a U-Visa certification must be forwarded to the Office of General Counsel for review.

#### **4-690 HANDLE WITH CARE PROGRAM**

The Handle with Care (HWC) program is a partnership between the Charles County Sheriff's Office and Charles County Public Schools. The goal of the program is to provide children who have been exposed to a traumatic incident a safe and reassuring environment while remaining in schools and in their classrooms, and to provide for the possibility of on-site mental health services at the schools, if needed.

##### **4-690.1 PURPOSE AND SCOPE**

**Administrative and Operational Manual****September 12, 2022**

The purpose of the HWC program is to prevent children's exposure to trauma and violence, mitigate negative effects experienced by children's exposure to trauma, and to increase knowledge and awareness of the issues caused by such exposure. HWC is a collaborative effort to designed to address childhood traumas and Adverse Childhood Experiences (ACEs).

ACEs can come in many forms and have been shown to influence how a child grows into an adult and their likelihood of continuing in some course of negative conduct as they get older. Examples of ACEs officers may witness a child encountering include:

- Drug addicted parents
- Domestic violence – both physical violence and emotional trauma
- Physical and/or sexual child abuse
- Death of a parent
- Incarceration of a parent
- Police enforcement activities at the child's home
- Alcoholism within the home
- Hunger and/or poverty

HWC provides the child's school with a "heads up" when a school-aged child has been identified as being involved in or exposed to some form of traumatic event.

#### **4-690.2 LAW ENFORCEMENT RESPONSIBILITIES**

In addition to any and all other care and safeguards which must be addressed during a traumatic incident, the officer will determine if any children are involved, witnessed the incident, or are likely to be impacted by the incident. The officer will attempt to determine each child's name, date of birth or age, if they attend a public school in Charles County and, if so, the name of the school. If the child was exposed to a traumatic event and attends a public school in Charles County, the incident will qualify for the HWC program and the officer will follow the HWC protocols listed in this policy to the best of his ability.

Many incidents can be considered traumatic for a child. As a guide, officer should consider the ACEs listed within this policy as an example of when HWC should be implemented.

If children are present on the scene, the officer will attempt to take appropriate steps to minimize the impact on the children. When circumstances allow, this may include removing the children from the room before making an arrest or conducting victim/witness interviews, talking with the children about the incident, and/or providing parents/guardians with victim/witness resource information.

In cases of suspected child abuse or neglect, the notification to the schools of an HWC incident will not replace the need for a Child Protective Services Intake Report (Form #280) to be completed.

#### **4-690.3 PROTOCOLS AND CONFIDENTIALITY**

Once the traumatic incident has been addressed, the officer must determine if there is a child involved who qualifies for the HWC program. If so, the officer will make an HWC notification to the Charles County Public Schools by using the CCSO HWC notification link on the Agency intranet, located under the "Reports" tab.

The only information to be provided through the intranet link is the child's first and last name, date of birth or age, and the name of the child's school.



Administrative and Operational Manual

September 12, 2022

---

If the intranet is not working, an email will be sent to one of the School Resource Unit supervisors who will then forward the information to the appropriate school official. In these cases, the subject of the email should read, "Handle with Care", and the body of the email should only contain the following information: the child's first and last name, date of birth or age, name of the child's school, and that there was a "Handle with Care" incident or that the child should be handled with care. For example:

Email Subject Line: *Handle with Care*

Body of Email: *Johnny Smith, Age 16, Thomas Stone High School – Handle with Care*

**NO INFORMATION SURROUNDING THE NATURE OF THE INCIDENT IS TO BE RELAYED TO THE CHARLES COUNTY PUBLIC SCHOOLS BY WAY OF THIS NOTIFICATION.**

Notification can be made for any incident that an officer believes may impact a student's behavior in school. Supervisory approval is not required to send a notification.

If the officer is able to identify additional school-aged children who may be impacted, but are not home at the time of the traumatic incident, the names, dates of birth or ages, and schools of those additional children may be provided as well.

The HWC program will not be implemented for children who are charged with a crime.

Current policy only applies to children enrolled in Charles County Public Schools.



## Administrative and Operational Manual

September 12, 2022

## 4-700 CRIMINAL INVESTIGATION

### 4-700.1 CRIMINAL INVESTIGATIONS DIVISION - GENERAL RESPONSIBILITIES

The Criminal Investigations Division shall have the primary responsibility for conducting investigations of the following crimes:

- All deaths of a suspicious or criminal nature;
- All shootings unless accidental;
- Serious aggravated assaults;
- Arson involving injuries;
- Child Abuse;
- Rape and Sexual Offense: 1<sup>st</sup>, 2<sup>nd</sup> and 3<sup>rd</sup> Degree;
- Robberies;
- Kidnapping / Extortion;
- Burglary;
- Abduction;
- Forgery and Uttering, Embezzlement, Credit Card Offense, Theft by Deception (Flim-flam);
- Violation of Narcotics and Vice Law;
- Follow-up investigation of reports taken by patrol officers and approved by division commanders / supervisors; and
- Special investigations assigned by the Sheriff or Assistant Sheriff of Operations.

### 4-700.2 REPORT WRITING

The patrol officer is usually the first to arrive on the scene. His first responsibility is to provide aid to the injured, then begin the preliminary investigation. On crime scenes where it is obvious that CID personnel will be handling the investigation, the detective may write the initial investigative report. If the initial report is handled by the responding detective, the patrol officer(s) will submit a supplement report detailing their actions and any information they obtained.

### 4-700.3 AUTO THEFT INVESTIGATIONS - IDENTIFYING STOLEN VEHICLES

During the investigation of auto thefts, the officer may encounter a vehicle missing the Public Vehicle Identification Number. All vehicles are required to have such a number. It is a violation of Criminal Law, § 6-306 of the Maryland Annotated Code for a person to remove such a manufacturer's plate or for a person to possess or offer for sale any article where such a number has been removed (see copy of law attached).

In the event a motor vehicle is discovered to be missing the manufacturer's serial number, the following policy will be adhered to:

- The vehicle will be seized;
- The Criminal Investigations Division will be notified and will initiate efforts to locate confidential vehicle identification numbers;
- The Criminal Investigations Division will conduct the follow-up investigation, using all means available to identify the appropriate owner;
- If the appropriate owner is identified, the detective handling the case will notify the owner. The owner will





Administrative and Operational Manual

September 12, 2022

---

be asked if he/she wishes to take possession of the vehicle. If so, the owner will be required to complete and sign the appropriate form advising him / her of the violation and the owner's responsibilities:

- CCSO Form #33 (06/01) - Release of vehicle without official V.I.N., to be retitled in the State of Maryland;
- CCSO Form #34 (06/01) - Release of vehicle without official V.I.N., to be retitled in another state.

The owner of said vehicle will be required to pay any and all storage bills incurred by the Office of the Sheriff prior to taking possession.

If the vehicle owner does not request possession of the vehicle and indicates no intention of obtaining the vehicle, he/she she will be asked to sign an Authorization for Destruction or Salvage.

- CCSO Form #32 (06/01) - Release of vehicle / article for purposes of salvage or destruction.

If the authorization is requested prior to the vehicle being destroyed or offered for salvage, the Commander of the Criminal Investigations Division will review and approve the authorization. If the owner has not been established, and all means have been exhausted, the CID Commander may authorize the destruction of the vehicle.



Administrative and Operational Manual

September 12, 2022

[REDACTED]

[REDACTED]

[REDACTED]

[REDACTED]

- [REDACTED]

- [REDACTED]

- [REDACTED]

- [REDACTED]

- [REDACTED]

- [REDACTED]

[REDACTED]

[REDACTED]

[REDACTED]

[REDACTED]

- [REDACTED]

- [REDACTED]



---

[REDACTED]

[REDACTED]

[REDACTED]

[REDACTED]

[REDACTED]

- [REDACTED]
- [REDACTED]
- [REDACTED]
- [REDACTED]

[REDACTED]

[REDACTED]

- [REDACTED]
- [REDACTED]
- [REDACTED]



## Administrative and Operational Manual

September 12, 2022

## 4-702 SEX CRIMES

The initial contact with the victim of a sex crime is critical to a successful investigation and conclusion of the case. Because of the nature of these offenses, the victim must be treated with patience and understanding. There will probably be a need to obtain quick lookout information; however, this need must be considered and handled in light of the victim's condition and state of mind. The victim's emotional and physical health should be of primary concern to the initial responding officer and investigator. The Sheriff's Office is committed to the compassionate treatment of victims of sex crimes.

### 4-702.1 INITIAL RESPONSE

Patrol officers will generally be the first to have contact with a victim. They do not have the responsibility to completely investigate first or second degree rape nor third degree sex offenses. Their responsibilities do include the following:

- Quickly assess the need for medical attention by the victim and provide this attention as it is found to be needed;
- Dependent upon the victim's condition, obtain a description of the suspect(s) and of any involved vehicle(s);
- Verify in general that a specific crime has occurred (it is not necessary at this point to ask for specific graphic descriptions of the particular acts committed);
- Broadcast a radio lookout for any suspect(s) and/or vehicle(s), giving their last known direction of travel if that information is available;
- Request additional officers, a supervisor, and Criminal Investigations as needed;
- Protect the victim from further trauma by calm reassurance and removal to a private area as soon as possible;
- Locate and protect the crime scene, including the physical evidence on the victim's body (this should be accomplished by explaining to the victim the need to not bathe, change clothes, eat or drink);
- Sympathetically listen to the victim's feelings and emotions, providing verbal support; however, the victim should not be touched or held except to provide immediately needed first aid;
- Keep the victim continually informed as to what is happening and how and why the investigation is being conducted;
- Patrol officers are expected to handle the complete investigation of fourth degree sex offenses only and should conduct in-depth interviews in these cases only, unless they are specifically assigned to do otherwise by an investigator or supervisor;
- When conducting neighborhood or witness interviews, do not volunteer the information that you are investigating a rape or sex crime; instead indicate when necessary that it is a serious crime or assault;
- The initial responding officer and any officer who in any way participates in the initial response to a sex offense will complete a supplemental report. This report is particularly required of any officer who questions the victim, a witness, or a suspect. It is also required of an officer who participates in a neighborhood canvass, search for or protection of the crime scene or any piece of evidence, or who, in responding to the scene, noticed anything unusual or of interest in the case.

### 4-702.2 CRIMINAL INVESTIGATIONS' RESPONSIBILITIES

It shall be the responsibility of criminal investigators to assume the investigation of all reported first and second degree rape cases, and third degree sex offense cases. If the initial report of the offense is made within 15 days of its occurrence, the detective assigned will call the SANE to conduct an examination and collect any physical evidence. In the case of a child victim, this examination may be conducted even if the report is not received within 15 days of the assault. The primary detective in the case is responsible to decide the value of such an examination



## Administrative and Operational Manual

September 12, 2022

in these cases.

### 4-702.3 VICTIM INTERVIEWS

The following guidelines will be adhered to when conducting interviews of victims of sexual assault. The investigating officer should endeavor to make the interview as comfortable as possible for the victim while, at the same time, acquiring the information necessary to successfully conclude the case.

- The interviewer should make a professional introduction and express his sincere concern for the victim's well-being and his devotion to a successful conclusion of the case;
- The victim should be addressed with dignity using the victim's last name and appropriate title;
- Assure the victim that the Sheriff's Office will vigorously pursue the suspect and in all possible ways provide for the victim's safety;
- Express an empathetic attitude toward the victim and provide assurance that the crime was not the fault of the victim;
- Convince the victim of the competence and experience of the interviewer and explain the necessity of asking very personal questions;
- Explain that the interview will be as brief as possible, consistent with the need to obtain information critical to the successful arrest and prosecution of the assailant;
- A formal written statement will not be taken from victims of sex crimes, nor will victims be requested to submit to, or otherwise provide, a polygraph examination;
- An initial interview may be delayed due to the victim's physical or emotional condition and, in any event, a second interview will be conducted at a point where there has been sufficient time since the assault to allow the victim to recover from the initial stress induced by that event;
- The victim will be provided the name and telephone number of the primary investigator in order that there remains a flow of information between the Sheriff's Office and that victim during the course of the investigation and any subsequent prosecution of the case;
- The victim should at all times be made to feel safe, guiltless, and confident in what will be done as a result of her cooperation with the Sheriff's Office.
- If the victim is a juvenile, depending on the circumstances of the investigation, the officer/detective shall consider whether a forensic interview is needed.
- Forensic interviews of juveniles shall, if practical, be conducted at the Center for Children located in La Plata.

### 4-702.3.5 VICTIM OF SEXUAL ASSAULT – WAIVER OF RIGHTS – PROHIBITED

In this section, "sexually assaultive behavior" means an act that would constitute a sexual crime, sexual abuse of a minor or sexual abuse of a vulnerable adult.

At no time during an interaction with a victim of sexually assaultive behavior will any employee present a victim with a form purporting to:

- relieve the Sheriff's Office of an obligation to the victim;
- preclude or define the scope of an investigation by the Sheriff's Office into an act allegedly committed against the victim;
- prevent or limit prosecution of an act allegedly committed against the victim; or
- limit a private right of action of the victim pertaining to an act allegedly committed against the victim or the victim's interaction with the Sheriff's Office.



## Administrative and Operational Manual

September 12, 2022

**4-702.3.6 VICTIM OF SEXUAL ASSAULT – REQUEST TO SUSPEND INVESTIGATION**

If a victim of sexually assaultive behavior requests that the scope of an investigation be limited or that an investigation be temporarily or permanently suspended, the investigator will advise the victim that the investigator or another officer will follow up with the victim within 30 days to confirm the victim continues to request the suspension of the investigation. The investigator will discuss with the victim how and when the follow-up contact will be made; the victim will be asked the preferred manner for the follow up (e.g., phone, e-mail, or in-person and if a voice mail can be left). The investigator will document the victim's preferences in an incident or supplemental report.

If, during the follow-up contact, the victim continues to request that the investigation be suspended, the officer will advise the victim that a decision to suspend an investigation is not permanent and the investigation can be reopened should the victim choose to pursue a criminal investigation at a later date, subject to any applicable statute of limitations. The victim will be provided with appropriate contact information. The follow-up contact will be documented in a supplemental report.

**4-702.3.7 VICTIM OF SEXUAL ASSAULT – CONFIDENTIALITY PROTECTIONS**

The officer/investigator should honor the confidentiality of the victim as much as possible.

Officers/investigators should make efforts to provide a private and comfortable space for victims, especially when being asked to disclose details of their case.

Officers/investigators should make an effort to limit the number of disclosures that need to be made.

Officers/investigators should be aware, and advise victims if appropriate, that the details of their case can, and will, become a matter of public record and cannot be fully protected as confidential.

Victims should be advised that the services provided by certified sexual assault crisis programs are confidential and that information discussed with sexual assault crisis program will not be shared with the investigator without the victim's consent.

**4-702.4 SEXUAL ASSAULT NURSE EXAMINER PROGRAM**

The SANE program was established to better serve the victim and the law enforcement officer in dealing with rape and sexual assault cases. The program utilizes a group of specially trained nurses who conduct the entire sexual assault examination. They collect evidence from both adult and child victims.

The SANE is committed to a single victim and will stay with that victim throughout the process. Consequently, the victim spends less time in the emergency room and the continuity of the examination and investigation is enhanced. All SANE examinations will be will be conducted in coordination with Charles Regional Medical Center (CRMC).

**4-702.5 CALL OUT OF SANE NURSES**

The SANEs are on call twenty-four (24) hours a day. These nurses will only be called out by the Charles County Sheriff's Office. The decision to call out a SANE will be made by the detective assigned as the primary criminal investigator in the reported sexual assault. Nurses assigned to the SANE program have been instructed that a detective will be present at the hospital in all cases other than Jane Doe exams. The Jane/John Doe Examination procedures are documented in the CID SOP.

There are a few sexual assault cases which occur within Charles County that are handled by another police agency, such as the Maryland State Police. If Communications receives a call from an investigator of another police agency requesting the call out of a SANE, the investigator of the other police agency will follow the guidelines set forth at CRMC regarding the SANE protocol. If there are any questions in this regard,



Administrative and Operational Manual

September 12, 2022

Communications should contact the CID contact person (CID Detective/Sergeant or Commander as designated on the daily lineup).

The nurse's sole responsibility will be the examination of the victim and collection of evidence.

#### 4-702.6 VICTIM SUPPORT

The SANE will contact a rape crisis worker or counselor to provide emotional support for the adult victim at the hospital. In cases of child victims, the detective will notify the Department of Social Services, Protective Services, as required by case circumstances.

#### 4-702.7 EVIDENCE AND REPORTS

The evidence gathered and the reports made by the SANE will be given to the detective when contacted by the SANE. In addition to reports of the examination, the SANE will complete a Department of Health and Mental Hygiene (DHMH) Form 2923. This form requires certain information, including a police case number. The primary detective will provide that case number to the SANE before the victim leaves the emergency room. The detective will also provide any other information needed to complete the DHMH form. The completion of this form is mandatory in all cases where a SANE conducts an examination.

#### 4-702.8 SEX OFFENDER REGISTRY PROGRAM

In 1994, federal guidelines established the National Sexual Offender Registry, sometimes referred to as "Megan's Law." In response to the new federal requirements, the Maryland General Assembly in 1995 created minimum standards for a state sexual offender registration program. Under the current state law, the Department of Public Safety and Correctional Services is charged with the creation and maintenance of a registry of individuals convicted of certain crimes against children and other sexual offenses. The Department of Public Safety and Correctional Services maintains an internet site which contains all registered offenders in the state ([www.dpscs.state.md.us](http://www.dpscs.state.md.us)).

The Department of Public Safety and Correctional Services, according to Maryland statute, has adopted policy designating local law enforcement as having the responsibility to monitor the registration of persons convicted of child sexual offenses, within their respective jurisdictions. On a local level, the Charles County Sheriff's Office is charged with this function.

#### CLASSIFICATION OF OFFENDERS:

Classification of offenders is based on the offender's conviction. Maryland statutes classify sex offenders in one of three categories. The category, or tier, determines how an offender is required to register, the frequency the offender must re-register and the duration of registration.

- Tier I: Offender to re-register every 6 months | 15-year registration
- Tier II: Offender to re-register every 6 months | 25-year registration
- Tier III: Offender to re-register quarterly | lifetime registration

When the offender's conviction information is entered into MOSOR the system will identify the offender's Tier. To ensure its accuracy, the SOR Coordinator may reference the registration scheme provided by the Sex Offender Registration and Notification Act (SORNA). The scheme includes the section code, offense and victim's age for offenses that qualify for placement on the registry. This will assist with determining the appropriate Tier for the



Administrative and Operational Manual

September 12, 2022

offense which the offender was found guilty of committing. The agency also uses the software program, Offender Watch. This program helps law enforcement provide reliable information to the public concerning sexual offenders living in their community.

A senior detective from Criminal Investigations Division assigned in the Special Victims Unit shall be assigned the Agency's Sex Offender Registration Coordinator. This detective will oversee the SOR program and ensure all requirements are being met. A second detective assigned in the Special Victims Unit shall be assigned as the SOR Investigator. This detective will have primary responsibility for maintaining the Sexual Offender Registry (SOR) for Charles County. Along with the detective, CID's technical assistant may also be assigned to assist with maintaining the Sexual Offender Registry (SOR) and all administrative documents.

Offenders meeting the criteria set forth by the state will be registered in the manner outlined in Maryland's sex offender statutes. The Sex Offender Investigator will maintain a working knowledge of current laws and regulations adopted by the state, County and Agency. The Investigator shall also prepare and maintain guidelines for administering the program as well as the physical registration of the offenders.

Once an offender is registered, a file will be created by the Investigator containing all documents mandated by law as well as a current photograph of the offender. These files will be secured in the Investigations Section and maintained by the SOR Investigator. The registration information contained in the offender files shall be forwarded to the Department of Public Safety and Correctional Services to be placed in their files and onto the internet site.

Offenders who become non-compliant with SOR requirements will be the subject of an immediate investigation and charged accordingly with any violations of Maryland and/or federal law.

4-702.9 SEX OFFENDER ADDRESS VERIFICATION

The Agency's Sex Offender Registration Investigator within the Investigations Section will be assigned to conduct address verification checks on registrants to ensure they are following the requirements of the sex offender statutes. Although the address verification check is not required by law, each registrant should be checked throughout the year by visiting the registrant's residence or place of employment. The Investigator or assigned detective conducting the verification check shall complete a Sex Offender Address Verification Form #881. The completed address verification form shall be placed in the offender's registration file.

- The frequency of the verification checks will be determined by the Investigator based upon the classification of the offender and the offense committed.

If a violation is discovered during the address verification check, the violation is to be documented on the verification form and the Investigator will take follow-up action, to include an incident report and charging document if warranted.

Detectives should keep in mind that offenders are under no legal obligation to cooperate in providing information as long as they are registered as required by state statute.

SEX OFFENSES - Annotated Code of Maryland, Criminal Law (Quick Reference)

<b>Rape</b> (Section 3-303) <b>First Degree</b> Penalty: Life	Vaginal Intercourse or sexual act by force or threat of force, and: 1) Employs a weapon, or 2) Inflicts: suffocation, strangulation, disfigurement, serious physical injury, or 3) Threatens death, any of #2 above, kidnapping, or 4) Acts with the aid of another person, or 5) In connection with a burglary in the first, second, or third degree.
--	---

<b>Rape</b> (Section 3-304)	Vaginal Intercourse or sexual act, and: 1) Employs force or threat of force, or
--------------------------------	--





Administrative and Operational Manual

September 12, 2022

<b>Second Degree</b> Penalty: 20 Yrs.	2) The victim is substantially cognitively impaired, mentally incapacitated, or physically helpless, or 3) The victim is under 14 and the suspect is 4 or more years older.
--	--

<b>Sex Offense</b> (Section 3-307) <b>Third Degree</b> Penalty: 10 Yrs.	Sex Contact against the will and without consent of the victim, and: 1) Employs a weapon, or 2) Inflicts: suffocation, strangulation, disfigurement, serious physical injury, or 3) Threatens death, any of #2 above, kidnapping, or 4) Acts with the aid of another person, or 5) The victim is substantially cognitively impaired, mentally incapacitated, or physically helpless, or 6) The victim is under 14 and the suspect is 4 or more years older. Sex act or vaginal intercourse where victim is 14 or 15 and suspect is at least 21.
--	--

<b>Sex Offense</b> (Section 3-308) <b>Fourth Degree</b> Penalty: 1 Yr.	1) Sex Contact against the will and without the consent of the victim, or 2) Sex Act with a person who is 14 or 15 and the suspect is 4 or more years older, or 3) Vaginal intercourse with a victim who is 14 or 15 and the suspect is 4 or more years older.
---	--

**DEFINITIONS (Effective: 10/1/17)**

**Mentally Incapacitated** - Means a victim who, due to the influence of any drug or act committed upon the victim, is rendered incapable of appraising the nature of the conduct, or of resisting the act (Section 3-301 (c)).

**Physically Helpless** - Means (1) a victim who is unconscious; or (2) a victim who does not consent to the act and is physically unable to resist the act or communicate unwillingness (Section 3-301 (d)).

**Sexual Act** - Means cunnilingus, fellatio, anilingus, or anal intercourse; also, includes placing any object or part of an individual's body into a genital or anal opening with the intent to obtain sexual gratification (Section 3-301 (e)).

**Sexual Contact** - Means the intentional touching of any part of the victim's or actor's anal or genital areas or other intimate parts for the purpose of gratification of either party (Section 3-301 (f)).

**Substantially Cognitively Impaired** - Means an individual who suffers from an intellectual disability or a mental disorder, either of which temporarily or permanently renders the individual substantially incapable of: 1) appraising the nature of the individual's conduct; 2) resisting vaginal intercourse, a sexual act, or sexual contact; or 3) communicating unwillingness to submit to vaginal intercourse, a sexual act, or sexual contact (Section 3-301(f)).

**Vaginal Intercourse** - Means genital copulation (Section 3-301 (g)).

- Notes:**
- 1) If victim is the spouse of the suspect see Section 3-318 for guidance because some of the above may not apply.
  - 2) All the above is paraphrased and therefore if there is any doubt concerning a particular charge the appropriate section of Criminal Law should be consulted.



---

## **4-703 CRIMES IN THE COUNTY DETENTION CENTER**

### **4-703.1 MAJOR CRIMES**

When notified by the Detention Center, a member of the Criminal Investigations Division will respond to the victim's location to initiate an investigation. Major crimes are homicide, rape, robbery, escape, etc.

### **4-703.2 MINOR CRIMES**

The investigation of minor crimes which will result in internal administrative charges only, shall be the responsibility of Corrections Personnel.

Minor crimes which will result in formal criminal charges, will be investigated by Patrol Operations personnel.

Minor crimes are simple assaults, destruction of property, vandalism, etc.

### **4-703.3 SECURITY OF VICTIM / INMATE**

This Agency will maintain responsibility for the security of any inmate taken to a hospital or confined in the hospital. In an instance where a federal inmate housed at the detention center is hospitalized, the Charles County Sheriff's Office will maintain custody and security until the appropriate federal authority is notified by Corrections personnel, responds and assumes responsibility for the inmate.



## Administrative and Operational Manual

September 12, 2022

## 4-704 CHILD NEGLECT CASES

### 4-704.1 RESPONSIBILITY TO INVESTIGATE

The investigation of child neglect is the primary responsibility of the Department of Social Services, Protective Services Division.

All complaints of suspected child neglect received by this Agency shall be directed to the station officer. He shall obtain as much information as possible from the complainant to assist him in determining if the child is in immediate danger. He may also dispatch an officer to the scene for personal observation and to gather information.

In cases where child neglect exists, but the child is not in immediate danger, the station officer shall complete a Suspected Child Abuse / Neglect Report Form #280 prior to going off-duty. Notify the Department of Social Services on-call person and forward the report to the Criminal Investigations Division.

In cases where child neglect exists and the child is in immediate danger, Protective Services will be contacted concerning proper placement of the child. The officer will not place the child in the care of custody of persons identifying themselves as neighbors or friends unless authorized by a Protective Services worker.

### 4-704.2 EXAMPLES OF CHILD NEGLECT

Child neglect cases are essentially cases involving children who are in need of assistance or supervision and the parent / guardian of the child is unable or unwilling to correct the condition affecting the child. Examples:

- An unattended or abandoned child, or a child without adequate supervision;
- A child suffering from malnutrition;
- A child without proper shelter or sleeping arrangements;
- A child unlawfully kept from attending school;
- A child who is emotionally disturbed due to continuous friction in the home, marital discord, or mentally-ill parents;
- A child in need of medical, dental or surgical treatment.

Child neglect cases are not limited to these examples. Juveniles who are constant runaways or truants may also be victims of child neglect. Constant domestic or neighborhood dispute / disturbance calls involving children may also reveal cases of child neglect.

In many instances, child neglect cases could also be deemed child abuse cases. If the determination can be readily made that it is a child abuse case, the investigation will be conducted by a member of the Criminal Investigations Division according to procedures set forth in the agreement between the Charles County Department of Social Services, Charles County Health Department, Charles County Sheriff, Maryland State Police and the State's Attorney for Charles County.

### 4-704.3 MARYLAND SAFE HAVEN PROGRAM

Maryland Courts and Judicial Proceedings and the Code of Maryland Regulations provide for the safe abandonment of a newborn infant at a hospital, designated facility (which includes a State Police Barracks / local police department), or with a responsible adult. Mothers may leave a newborn infant at a designated facility or with a responsible adult with immunity from civil or criminal prosecution. The infant must be three (3) days or less in age, unharmed, and the mother must have no intent to return and claim custody. The abandonment may be done through a third party responsible adult with permission from the mother.



Administrative and Operational Manual

September 12, 2022

#### 4-704.4 EMPLOYEE RESPONSIBILITIES

Sheriff's Office employees may find themselves called upon to accept a newborn infant under the guidelines of the law. If the mother of an infant or a responsible adult makes contact with an employee at a Sheriff's Office facility and wishes to abandon custody of the infant, certain procedures must be followed.

Employees will attempt to identify the mother of the infant and determine if the criteria is met for a safe abandonment. A detective will respond to the location and conduct an initial investigation to establish:

- age of the infant, with reasonable medical certainty (attached umbilical cord);
- identification of the mother and the infant;
- overall health of the infant, (no evidence of abuse or neglect);
- the intent of the mother not to return for the infant and abandon parental custody.

EMS will immediately be contacted to provide for care and transport of the infant to a hospital. Detectives will consult with the State's Attorney to determine the criteria of the law is met, and the safe abandonment of the infant will be allowed with no civil or criminal liability of the mother. The detective will immediately contact the Department of Social Services and advise a case worker of the situation.

In the event of an abandonment of an infant at a designated facility other than the Sheriff's Office, an investigation will be completed in the same manner by officers from this Agency.



## Administrative and Operational Manual

September 12, 2022

## 4-705 CHILD ABUSE CASES

### 4-705.1 RESPONSIBILITY TO INVESTIGATE

Primary responsibility for the investigation of alleged child abuse rests within the Criminal Investigations Division. This responsibility extends to physical or sexual abuse or exploitation. Cases that fall within the scope of Criminal Law, § 3-601 include:

- Any abuse situation in which the victim is under 18 years of age and a custodial relationship exists between the suspect and the victim or the suspect is a regular household member (i.e., parents, step-parents, guardian, babysitter, roommate etc.).

**NOTE:** The child abuse statute does not include assaults upon children by persons not in a custodial relationship (e.g., neighbor, stranger, etc.); however, it does include siblings in a non-custodial role.

### 4-705.2 AUTHORITY FOR TAKING A CHILD INTO CUSTODY

(Courts & Jud. Proc. § 3-8A-14 Juvenile Cases, Annotated Code of Maryland)

A child may be taken into custody by any of the following methods:

- Pursuant to an order of the court;
- By a law enforcement officer pursuant to law of arrest;
- By a law enforcement officer who has reasonable grounds to believe that the child is in immediate danger from his surroundings and that his removal is necessary for his protection; or,
- By a law enforcement officer who has reasonable grounds to believe that the child has run away from his parents, guardian, or legal custodian.

### 4-705.3 ASSISTING PROTECTIVE SERVICES WITH CHILD REMOVAL

Authority for Removal - Immediate Danger Situations (Family Law, § 5-709):

- If a Protective Services representative has probable cause to believe that a child is in serious physical danger and that an emergency situation exists, the representative may enter the household. If denied entry, a law enforcement officer shall accompany the representative;
- The officer may use reasonable force to gain entry;
- If the danger proves to be genuine, the representative may remove the child from the house.



## Administrative and Operational Manual

September 12, 2022

## 4-706 EYEWITNESS EVIDENCE

Eyewitnesses, who include complainants and victims, play a critical role in the criminal justice system. They are often essential to identifying, charging, and ultimately convicting perpetrators of crime, and in some cases may provide the sole piece of evidence against those individuals. For these reasons, the value of accurate and reliable eyewitness evidence cannot be overstated.

Recognizing the weight accorded eyewitness evidence by judges and juries, the State of Maryland created and passed HB 1200, effective October 1, 2014, which states the procedures to be followed in accordance with the Police Training Commission's Eyewitness Identification Model Policy. The procedures are codified at § 3-506 and § 3-506.1 of the Public Safety Article of the Maryland Code.

### 4-706.1 DEFINITIONS

Definitions of terms used in this section:

**Administrator:** A person conducting an identification procedure.

**Blind:** The administrator does not know the identity of the suspect.

**Blinded:** The administrator is unable to see the photographs being viewed by the eyewitness.

**Eyewitness:** A person who observes another person at or near the scene of an offense.

**Filler:** A person or photograph of a person who is not suspected of an offense and is included in an identification procedure.

**Show-up:** The live presentation of one suspect to an eyewitness shortly after the commission of a crime.

**Photo Array:** A display of a photograph of the suspect along with at least five filler photographs of other individuals whose physical characteristics resemble the suspect's description or appearance at the time of the incident.

**Composite:** Representation of description(s) of a suspect provided by witness(es). Composites may be completed by an artist, computer program, or Identi-Kit.

### 4-706.2 INITIAL REPORT OF A CRIME – CALL TAKER AND FIRST RESPONDER RESPONSIBILITIES

As the initial point of contact for a witness, the call taker should obtain and disseminate complete and accurate information from the caller. This information can include the description and/or the identity of the perpetrator of a crime. The actions of the call taker and Police Communications Officer (PCO) can affect the safety of those involved as well as the entire investigation.

After obtaining preliminary information and entering it into the CAD system for dispatch, the call taker should assure the caller the police are on the way. Based on the type of call, the call taker may want to ask for more information using open-ended questions, which allows for an unlimited response from the witness (e.g., "What can you tell me about the perpetrator?" or "Tell me in your own words what happened"). The call taker should follow with more directed questions if the caller is unresponsive to open-ended questions (e.g., "What type of weapon?" or "What make of vehicle?"). Call takers should avoid asking leading questions. Leading questions suggest an answer and may distort the caller's perception or memory.



## Administrative and Operational Manual

September 12, 2022

The next point of contact for a witness will most likely be the first officer on the scene. The first responding officer is responsible to:

- obtain, preserve, and use the maximum amount of accurate information from the scene;
- locate and verify the identity of all witness(es);
- separate witnesses and instruct them to avoid discussing details of the incident with other witnesses;
- avoid saying anything to the witness(es) that may influence their accounts;
- determine / classify what crime or incident has occurred;
- attempt to identify the perpetrator(s);
- detain or arrest the perpetrator(s) if still present at the scene;
- attempt to determine the location of the perpetrator(s) if not on the scene;
- broadcast any updated description of the incident, perpetrator(s), and/or vehicle(s); and
- canvass the area for other witnesses.

Witnesses should not hear others' accounts because they may be influenced by that information. Independent witness statements can corroborate other witnesses' statements and other evidence in the investigation. The preliminary investigation at the scene forms a sound basis for the accurate collection of information and evidence during the follow-up investigation.

#### 4-706.3 CONDUCTING SHOW-UPS (Effective 3/29/19)

Prior to conducting a show-up, approval shall be obtained by a supervisor the rank of corporal or above. The supervisor shall take into consideration the totality of the incident including information provided by witnesses, the lapse of time between the incident and the identification process, and safety issues for the suspect and witnesses.

Show-ups may occur when there is a reasonable likelihood that a witness may identify or exclude a suspect as being involved in the incident.

Where practical, a witness will be transported to the suspect's location in a police vehicle out of view of the suspect. Multiple witnesses must be transported separately. Prior to bringing the witness to the location of the suspect, officers must review CCSO Form #108b with the witness and avoid any discussion with the witness beyond that Form.

#### 4-706.4 DOCUMENTATION OF SHOW-UPS (Effective 3/29/19)

The officer conducting the show-up shall, **if practical**, electronically record through the use of the digital mobile video/audio recorder (DMVR), the circumstances that led to conducting the show-up and the outcome of the procedure. The recording of this procedure would start with instructions, utilizing the Show-Up Identification Form #108b, being provided to the witness prior to the show-up, and would not end until after the witness exits the Agency vehicle.

This procedure would then be documented in a report or supplement. If the procedure is recorded on the digital mobile video/audio recorders (DMVR), follow Agency protocol to recover as evidence.

#### 4-706.5 PHOTO ARRAYS

There are times during an investigation in which the identity of a suspect or witness needs to be confirmed by way of a photograph. If the person making the identification is familiar with the suspect or witness, showing them a single photograph is acceptable.

If the person making the identification is not familiar with the suspect or witness, a photographic array will be conducted to determine the identity of the suspect or witness.



## Administrative and Operational Manual

September 12, 2022

#### 4-706.6 COMPOSING A PHOTOGRAPHIC ARRAY

When the need arises to conduct a photographic array, the officer conducting the array shall adhere to the following procedures:

- The array shall be composed by someone other than the administrator.
- The array shall not be composed by the primary officer handling the investigation.
- The officer presenting the array **shall not** observe the composing of the array.
- A one-suspect array shall be composed of six (6) individual photos, one (1) of the photos being that of the suspect.
- The photographs shall be selected so as not to cause the suspect selected to unduly stand out from the other photographs. To the best of the officer's abilities, each photograph shall resemble the description of the perpetrator given by the eyewitness in significant physical features, including any unique or unusual features.
- The officer composing the array shall document the identities of all photographs in the array on the Photographic Identification Form #108. Identifying all photographs will permit the investigating officer to follow-up on any identifications made by the witness.
- Each photo will be placed in a randomly-numbered folder and stapled or otherwise affixed to that folder. The number on the folder will correspond to the number used to document each photograph on the Photographic Identification Form #108.
- The folders will be shuffled.
- The administrator shall have no knowledge of the filler photos or the placement of the suspect photo within the folders.
- The officer who composed the array shall provide the folders to the administrator, along with the attached Photographic Identification Form #108a.
- If a witness has previously participated in viewing a photo array in connection with the identification of another person suspected of involvement in the offense, the filler photos **shall be** different from the filler photos used in any prior identification procedure.

#### 4-706.7 PRESENTATION AND DOCUMENTATION OF PHOTO ARRAYS

- The administrator will read the instructions on Form #108a to the eyewitness. The administrator will then hand the folders to the eyewitness.
- If the administrator is not a blind administrator, the administrator will become "blinded;" that is, the administrator shall conduct the presentation so that the administrator cannot see or track which photograph is being viewed by the eyewitnesses until after the procedure is completed.
- At the conclusion of the photo array, the officer shall document the required information on the Form #108a.
- If the witness made a positive identification of one of the photographs, they will be asked to affix their initials to the photograph.



**Administrative and Operational Manual****September 12, 2022**

- When possible, the presentation of the photo array should be audio and video recorded. If a video recording is not available, an audio recording should be made of the presentation. In the event neither is available, the presentation should be witnessed by a third party.
- The presentation procedures and the outcome of the presentation shall be documented on Form #108. The documentation shall include:
  - All identification and nonidentification results obtained during the identifying procedure;
  - The signed identification statement of the eyewitness;
  - The names of all persons present at the identification procedure;
  - The date and time of the identification procedure; and
  - Any eyewitness identification of a filler.
- If there are multiple witnesses, the identification procedure shall be conducted separately for each witness. The suspect's photograph shall be placed in a different position and number for each identification conducted for each witness. The witnesses may not be allowed to communicate with each other until all identification procedures have been completed.

**4-706.8 RETAINING PHOTO ARRAY AS EVIDENCE**

The entire photo array, to include the folders and the Forms #108 and #108a, shall be packaged as evidence and held for all court proceedings in the CCSO Property Management Section. A photocopy may be made prior to packaging for the investigator's use.

Any and all audio / video recordings of this procedure will be placed on a compact disc as evidence and held for all court proceedings.

**4-706.9 CID RESPONSIBILITIES**

The Criminal Investigations Division will be responsible for the composition of all photo arrays within the Agency.

Any officer outside the Criminal Investigation Division requiring a photo array will contact an on-call CID supervisor to request a photo array.

The CID supervisor will assign a detective to compose the photo array for the officer requesting the lineup.

If no CID personnel are on duty, the on-call CID supervisor will evaluate the need to call out a detective to handle the assignment immediately. Otherwise, the array will be assigned to a detective when they return to duty.

**4-706.10 DEVELOPING AND USING COMPOSITE IMAGES**

Composite images can be beneficial investigative tools; however, they should not be used as stand-alone evidence and may not rise to the level of probable cause. Composites provide a depiction that may be used to develop investigative leads.

Instructions to the witness prior to conducting the procedure can facilitate the witness' recollection of the perpetrator. Officers preparing a composite shall:

- instruct each witness without other persons present;
- explain the type of composite technique to be used;
- instruct the witness to think back to the event and his/her frame of mind at the time; and
- explain to the witness how the composite will be used in the investigation.



**Administrative and Operational Manual**

**September 12, 2022**

---

The person preparing the composite shall select and employ the composite technique in such a manner that the witness' description is reasonably depicted. The person preparing the composite should:

- assess the ability of the witness to provide a description of the perpetrator;
- select the procedure to be used from those available (e.g., IdentiKit-type, artist, or computer-generated images);
- avoid showing the witness any photos immediately prior to development of the composite, unless part of the procedure;
- select an environment for conducting the procedure that minimizes distractions;
- conduct the procedure with each witness separately; and
- determine with the witness whether the composite is a reasonable representation of the perpetrator.

#### **4-706.11 DOCUMENTING EYEWITNESS EVIDENCE**

Documentation of the eyewitness procedure provides an accurate record of the results obtained from the witness and can be an important factor in the investigation and any subsequent court proceedings. The officer conducting procedures shall preserve the outcome by accurately documenting the type of procedure employed and the results of the procedure by recording any identification or non-identification obtained from the witness.

The results of the procedure shall be documented in writing, including the witness' own words regarding how certain he/she is of any identification. Photos, composites, statements, and any other materials used by a witness to make an identification shall be signed and dated by the witness.



## Administrative and Operational Manual

September 12, 2022

## 4-707 ASSET SEIZURE AND FORFEITURE PROCEDURES

All asset seizure and forfeiture procedures will be conducted according to law. The Charles County Sheriff's Office prohibits officers from using bias based profiling in any enforcement program, including asset seizure and forfeitures.

### 4-707.1 FORFEITURE OF CDS MONIES

According to Title 12 of the Maryland Criminal Procedure Article, money used or intended to be used in connection with the unlawful manufacture, distribution, or dispensing of a controlled dangerous substance is contraband and presumed to be forfeitable. Mere proximity is no longer enough to support a seizure unless there is evidence that it was used or intended to be used in connection with the unlawful manufacture, distribution, dispensing, or possession of CDS.

Following a seizure, the Agency has 30 days to notify the owner by first class mail that the property is subject to forfeiture. The Criminal Procedure Article requires that contraband coin and currency seized pursuant to CDS offenses be photographed and a record of the quantity of each denomination of coin or currency be made. Officers seizing money in these cases shall photograph (not copy) the money. Seizures involving more than one bill shall be photographed as a whole (not individually). After processing, seized money will then be deposited with the County Treasury by Property Management personnel. Photographs may be substituted for the coin and currency in any criminal or forfeiture proceeding.

To apply for the forfeiture of money, a complaint and affidavit shall be filed in the District Court or the Circuit Court for Charles County by the State's Attorney's Office. The law requires the County to petition for the forfeiture of monies resulting from seizures for controlled substance offenses within ninety (90) days of the final disposition of the criminal case.

### 4-707.2 FORFEITURE OF GAMBLING MONIES

According to Title 13 of the Criminal Procedure Article, money is prima facie contraband if seized by an officer in connection with an arrest for:

- unlawfully playing or operating a bookmaking scheme;
- unlawfully betting on a horse race, athletic event, lottery, or game; or
- using an unlawful gaming table or gaming device.

The Criminal Procedure Article requires that contraband coin and currency seized pursuant to gambling offenses be photographed and a record of the quantity of each denomination of coin or currency be made. Officers seizing money in these cases shall photograph (not copy) the money. Seizures involving more than one bill shall be photographed as a whole (not individually). After processing, seized money will then be deposited with the County Treasury by Property Management personnel. Photographs may be substituted for the coin and currency in any criminal or forfeiture proceeding.

Monies shall be seized when there exists a clear connection to gambling violations. Through investigative means, every effort shall be made to clearly identify any potential claimants so that proper notification can be made. Pursuant to the law, when an officer seizes monies in connection with a violation of Maryland's gambling laws, he shall:

- sign and date the CCSO notice (Gambling Letter Form #859);
- have the person from whom the monies were seized, sign and date the form; and



Administrative and Operational Manual

September 12, 2022

- provide the person from whom the monies were seized with a copy of the form.

To apply for the forfeiture of money, a complaint shall be filed in the District Court or the Circuit Court for Charles County by the State's Attorney's Office. Application for forfeiture shall be made within ninety (90) days after entry of a conviction or plea, unless the case is appealed.

The law of forfeiture differs between CDS cases and gambling cases. The law specifically states that in order for seized monies to be forfeited in gambling cases, timely notice must be given of the requirements for making claim for the return of seized monies. The law states that a claimant must:

- apply within one year after the judgment or order was entered or the final disposition was taken; and
- give written notice to the financial authority (Charles County Treasurer's Office) at least ten days before filing the complaint.

Issuance of Form #859 will serve as timely notice of the requirements for making claim for the return of the seized monies. The original copy of the form will be maintained in the main case file and will serve as documentation that proper notification was made.

### 4-707.3 VEHICLES - NARCOTIC RELATED IMPOUNDS

A vehicle will be impounded and subject to forfeiture if it was used during any of the following narcotic-related violations:

- All felonies to include:
  - transporting, manufacturing, distribution, possession with intent to distribute controlled dangerous substances (CDS), and conspiracy to commit any of these offenses; and
  - transportation, possession of raw materials or products or equipment of any kind intended for use in any of these offenses.
- Misdemeanors (simple possession of CDS) if used in violation of the Controlled Dangerous Substances law (Criminal Procedures 12-204(b)) or if any of the following criteria are met:
  - Any quantity of a controlled dangerous substance is sold or attempted to be sold in violation of the Controlled Dangerous Substance law;
  - An amount of the controlled dangerous substance or paraphernalia is found that reasonably shows the violator intended to sell the controlled dangerous substance in violation of the Controlled Dangerous Substance law;
  - The total circumstances of the case as listed below in this section dictate that a seizure and forfeiture are justified:
    - the possession of CDS;
    - the violator has an extensive criminal record;
    - the violator has a previous conviction for a CDS violation;
    - evidence that the motor vehicle was acquired by use of proceeds from a transaction involving a CDS;
    - circumstances of the arrest;
    - the way in which the motor vehicle was used.



## Administrative and Operational Manual

September 12, 2022

When an officer seizes a vehicle in accordance with this section, he will document the circumstances and reason for seizure (i.e., possession of marijuana / crack cocaine) on the vehicle seizure forms and associated incident report.

If the situation does not meet the above criteria, the officer will not seize the vehicle. Proper procedure for storing the vehicle will be followed as directed elsewhere in this Manual.

The vehicle seizure program for incidents involving individuals possessing less than 10 grams of marijuana has been suspended. The following will apply:

- Vehicles **will not be seized** in incidents involving individuals possessing less than 10 grams of marijuana.
- Vehicles **will not be seized** in incidents involving individuals possessing less than 10 grams of marijuana, even if the individual is charged with the criminal violation of possession of paraphernalia.
- Vehicles **will be seized** in criminal marijuana incidents involving PWID, even if the amount of marijuana is less than 10 grams.
- Vehicles **will be seized** in all other criminal incidents involving CDS not marijuana, whether it is simple possession or PWID.

The State will have to prove at a forfeiture hearing that the purported owner of certain property (i.e., vehicles, real property, and anything of value furnished for CDS, to include bank accounts, securities, furnishings, proceeds, etc.) subject to forfeiture had actual knowledge that the property was used or intended to be used to accomplish violations of the CDS laws.

In addition, Maryland law now prohibits a law enforcement agency or the Office of the State's Attorney from directly or indirectly transferring seized property to a federal law enforcement authority or agency unless a criminal case related to the seizure is prosecuted in federal court (Criminal Procedures 12-212).

#### 4-707.4 HANDGUNS

Handguns seized pursuant to a violation of Criminal Procedure Article (unlawful wearing, carrying, transporting or use of a handgun) will be subject to forfeiture to the State of Maryland.

#### 4-707.5 CONVERSION OF CONFISCATED HANDGUNS TO POLICE USE

The Sheriff may convert handguns confiscated and forfeited to Charles County Sheriff's Office use. The Agency may also use such firearms for the purpose of trading with a licensed gun dealer to defray costs of purchasing new weapons.

### 4-708 DEATH INVESTIGATION / NOTIFICATIONS AND RESPONSIBILITIES

#### 4-708.1 NOTIFICATION OF MEDICAL EXAMINER

Any officer who responds to a death scene or who discovers a dead body shall determine whether the Medical Examiner's Office needs to be contacted. If it is determined there is a need for a representative from the Medical Examiner's Office, the on-call Forensic Investigator (F.I.) or Deputy Medical Examiner (D.M.E.) shall be contacted.

**Administrative and Operational Manual****September 12, 2022**

An on-call list is maintained at the District I station's front desk.

Deaths which require an investigation by the Medical Examiner's Office include:

- deaths resulting from trauma (such as violence, suicide or other casualty);
- deaths resulting from accidents (motor vehicle, aircraft, watercraft, train);
- deaths resulting from alcohol or drug intoxication (accidental or intentional);
- any sudden death if the deceased was in apparent good health or unattended by a physician;
- natural deaths in which the regular physician either cannot or will not sign a death certificate;
- natural deaths in which the deceased has no apparent regular physician; and
- any death of a suspicious or unusual manner.

Officers investigating deaths that appear to be natural should immediately contact the deceased's physician and notify them of the incident. The investigating officer should then ascertain if, based on the deceased's medical history, the physician would agree to sign the death certificate.

The on-call F.I. or D.M.E. should not be contacted for incidents that are determined to be natural deaths and the deceased's regular physician is signing the death certificate.

The on-call F.I. or D.M.E. should be contacted if the deceased's physician refuses to sign the death certificate or if the physician is not licensed in Maryland and therefore cannot sign the death certificate.

If the medical examiner determines they will accept the case, the officer shall immediately notify the State's Attorney of the facts concerning the time, place, manner, and circumstances of the death. The notification shall be documented in the Report of Death Form #35. Additional details regarding the notification to the State's Attorney will be included in the incident report, as needed.

#### **4-708.2 FORENSIC INVESTIGATOR / DEPUTY MEDICAL EXAMINER**

Each county in Maryland will have one or more physicians appointed by the State Postmortem Examiners Commission to act as the Deputy Medical Examiner(s) for that county. Forensic investigators shall be selected by the Chief Medical Examiner to investigate deaths on behalf of the Office of the Chief Medical Examiner. Forensic Investigators receive specialized training in death investigation and will work closely with the County Deputy Medical Examiner.

Upon arriving at the scene, the F.I. shall take charge of the body and conduct an investigation into the circumstances surrounding the death. If the incident is under the jurisdiction of the Medical Examiner's Office, the F.I. shall arrange for the transportation of human remains from the scene of the incident at the conclusion of the on-scene investigation.

If the cause of death can be established by the F.I. and D.M.E. within a reasonable degree of medical certainty, the County D.M.E. will sign the death certificate. If the cause of death cannot be determined as a result of the on-scene investigation, an autopsy will be ordered to continue the investigation. The F.I. on the scene will determine if an autopsy will be required and will notify the investigating officer.

#### **4-708.3 NOTIFICATION OF CRIMINAL INVESTIGATIONS DIVISION**

Once an officer confirms or pronounces a person deceased, a supervisor shall be notified of the circumstances surrounding the incident. The supervisor shall then respond to the scene if available and determine the need to contact the Criminal Investigations Division.



## Administrative and Operational Manual

September 12, 2022

The CID contact person listed on the CID daily lineup shall be notified of all deaths which are of a suspicious nature or as a result of a criminal act. The CID contact will determine if there is a need for an investigator to respond to the scene and assist with or assume the investigation.

There is no need to contact CID for deaths which are determined to be natural and there is no indication of foul play. If an officer determines a death appears to be from natural causes, the officer shall attempt to contact the deceased's physician as outlined in the Notification of Medical Examiner portion of this policy.

If, due to the nature of the incident, there was no need to immediately notify a representative of CID of the incident, the investigating officer shall place a notation on the Report of Death which indicates the notification was "Not Applicable."

For all incidents, whether CID was contacted or not, the investigating officer shall forward a copy of the Report of Death to the supervisor of the Major Crimes Unit as soon as practical. The preferred method of forwarding the report will be via email.

#### 4-708.4 MEDICAL ORDERS FOR LIFE SUSTAINING TREATMENT (MOLST)

A Medical Orders for Life Sustaining Treatment (MOLST) form includes medical orders for Emergency Medical Services (EMS) and other medical personnel regarding cardiopulmonary resuscitation and other life-sustaining treatment options for a specific patient. It is valid in all health care facilities and programs throughout Maryland and is codified under the Health-General Article 5-608. A copy of the form must be kept with the individual it applies to. The form must be signed and dated by an attending physician, physician's assistant, or nurse practitioner. When an individual expires with a valid MOLST form, it is considered an attended death and no incident report is required by the Sheriff's Office.

#### 4-708.5 DEATHS AT NURSING HOMES/LONG TERM CARE FACILITIES

The response for a subject not breathing at a medical facility will be Code 1. Officers will start an investigation as normal and obtain details in reference to the death to verify there are no suspicious circumstances, such as elderly abuse, neglect, etc. A death report **will not be taken if**: The death is natural and the facility physician or the decedent's physician will sign the death certificate. Before clearing with no report, officers will verify medical staff is notifying next of kin. The family is responsible for funeral arrangements. Officers do not need to wait for the family or funeral home. When clearing the call, the officer will enter notes in the call sheet detailing the name of the doctor who will sign the death certificate and clear the call with "attended death, no report." A death report **will be taken** if either physician will not sign the death certificate or there are suspicious circumstances.

#### 4-708.6 STATE ANATOMY BOARD

There are times officers may respond to a death investigation where no surviving next of kin can be located or surviving next of kin refuse to claim the decedent. If the decedent is not being transported to the Office of the Chief Medical Examiner and the officer has exhausted all available leads in contacting a cooperating next of kin, the Maryland State Anatomy Board will be utilized for disposition of the decedent. After being contacted, they will respond and take custody of the body. The contact information for the Anatomy Board is as follows:

Phone: 410-547-1222

Website: <https://health.maryland.gov/anatomy/Pages/index.aspx>

#### 4-709 TRUTH VERIFICATION FUNCTION

**Administrative and Operational Manual****September 12, 2022**

The Truth Verification Function is comprised of sworn members of the Agency who have successfully completed training from a recognized institution and who are certified in the use and interpretation of polygraph tests. The Function will conduct tests using only instruments purchased by the Agency and approved by the Supervisor, Truth Verification Function.

The Function will be supervised by a sworn member of the Agency holding the rank of Sergeant or higher. The Truth Verification Function will be managed through the Administrative Services Division. On matters related to this Function, the supervisor will report to the Commander, Administrative Services. Examiners assigned to this Function will have regular assignments throughout the Agency, but will be available to conduct examinations when necessary. While in the performance of their duties in association with this Function, the examiners will be supervised by the Supervisor, Truth Verification Function. When not performing a task related to this Function, the examiners will be responsible to their assigned chain of command.

It is the purpose of this policy to provide investigative officers and others with general knowledge of guidance and procedures for the use of polygraph examinations which will hereafter be referred to generally as an examination(s).

An examination is a valuable investigative aid in criminal or internal cases when used in conjunction with, but not as a substitute for, a thorough investigation. An examination may be employed, consistent with this policy, for such purposes to:

- verify, corroborate, or refute statements;
- obtain additional investigative leads;
- narrow or focus an investigation.

The polygraph is defined as an instrument that records certain physiological changes in a person undergoing questioning in an effort to obtain truth or deception. A polygraph simultaneously records a minimum of respiratory activity, galvanic skin resistance or conductivity, and cardiovascular activity.

#### **4-709.1 PURPOSE OF EXAMINATION**

Examinations may be authorized when consistent with state and federal law and Agency policy. Situations in which authorization may be requested and approved include, but are not limited to:

- a request from the State's Attorney's Office as part of an agreement with the defense attorney or for other investigative purpose;
- an element of a pre-employment investigation of a candidate for a sworn or civilian position in the Agency;
- a request from other authorized criminal justice agencies;
- an attempt to verify or reconcile statements of parents or guardians (e.g., in suspicious cases of missing or abused children) as well as witnesses or other individuals when alternative investigative means have been exhausted;
- an effort to establish probable cause to seek a search warrant;
- as part of an administrative or criminal internal investigation of an officer of this Agency or another criminal justice agency consistent with this policy.

The examination should not be used to verify a victim's / witness's allegation without sufficient grounds for suspecting that the victim / witness has given false or misleading statements.

When used as an element of a pre-employment investigation, the results of a polygraph test shall not be used as





Administrative and Operational Manual

September 12, 2022

the single determinant for making employment decisions. However, admissions made during the pretest, test or post-test interviews, together with other relevant information may be sufficient to support decisions regarding an applicant's employment status.

Examinations will not be conducted on victims of rape, sexual assault or child abuse.

#### 4-709.2 PROCEDURES FOR REQUESTING POLYGRAPH EXAMINATIONS

Once approved by their immediate supervisor, employees of this Agency may request an examination from one of the Agency's authorized examiners.

Any member of this Agency who wishes to employ an examination as part of an authorized investigation shall submit a Request for Truth Verification Examination Form #246 to the Supervisor, Truth Verification Function. The written request shall include copies of all relevant reports to include, but not be limited to:

- information obtained in the investigation that supports and justifies an examination;
- copies of crime or offense reports and investigative reports;
- evidence available and withheld from the subject;
- background information on the subject to be examined, to include criminal record and possible motivation;
- any statements made by the subject, complainants, and witnesses to include alibis;
- newspaper articles or other general information concerning the case.

The supervisor will review the request and associated reports and make a preliminary determination as to whether a test will be conducted. If approved by the supervisor, the case will be assigned to one of the examiners for review, a case number will be assigned, and a date and time will be set up for the test. The supervisor will send a copy of the request form to the requesting officer advising whether the case was approved for testing and, if so, who will be conducting the examination and the date and time the examination is scheduled.

After receiving a test case, the examiner will review the material and make the final determination on the suitability of the test. If an examiner feels that an examination should not or cannot be done, the examiner will provide the reason for the determination to the supervisor and the examination will not be conducted. The requesting employee will be notified by the Supervisor, Truth Verification Function and provided an explanation as to why the examination was not conducted.

If, because of the immediate need for an exam, it would be impractical to contact the Supervisor, Truth Verification Function, the requesting officer may contact an examiner directly and request an examination. In such an instance, the examiner will review the circumstances and suitability of the case and the individual to be tested and make a determination as to whether a test will be conducted. If such a request is made, the examiner will, as soon as practical, contact and inform the Supervisor, Truth Verification Function of the request and test, if one is conducted.

#### 4-709.3 SUITABILITY FOR EXAMINATION

Submission to an examination must be a voluntary action with the exception of an employee of this Agency formally directed to take an examination as part of an internal investigation. In all other cases, examinations shall not be administered without the subject's written approval, waiver, or other instrument as required by law.

Certain individuals and conditions are not conducive to successful testing and will generally be deemed unsuitable. Some examples of these individuals and conditions would be:

- children under the age of thirteen (13);

**Administrative and Operational Manual****September 12, 2022**

- elderly persons;
- individuals with medical problems;
- individuals with mental conditions;
- individuals who are extremely tired;
- individuals under the influence of alcohol; and
- individuals who are emotionally distraught.

If a subject has been interrogated by investigating officers prior to the exam, it shall be the examiner's discretion, based on his / her evaluation of the subject, as to whether or not an examination can be successfully conducted. The examiner shall have final authority on these matters.

If the subject is hearing impaired or does not speak English, the requesting employee will help make arrangements for a sign language interpreter or translator, as determined by the examiner.

In any interrogation of a suspect who has agreed, or who may reasonably be asked to agree, to an examination, requesting officers shall not pursue questions that may reveal information only the perpetrator could know. This includes, but is not limited to:

- method of entry;
- property taken;
- weapons or type of force used to commit the crime;
- evidence left at the scene;
- clothing worn by the subject during the crime;
- unusual acts of the suspect during the crime; and
- location from which property was taken.

Juveniles will not be tested unless at least one parent or guardian and/or a juvenile judge has signed a consent form. Juvenile tests will be handled in the same manner as adult tests; however, the examiner will take the subject's age and mental capacity into consideration when structuring the questions to be used during the test.

#### **4-709.4 REQUESTING OFFICER'S RESPONSIBILITIES**

Upon notification by the Supervisor, Truth Verification Function that the request for an examination has been approved and receiving the test date and time schedule, the requesting officer shall contact the subject to be tested and arrange for his / her appearance for the examination. If problems exist with the scheduled date and time, the requesting officer shall immediately notify the examiner assigned to the case to make other arrangements.

Requesting officers shall not attempt to explain procedures that will be used in the examination but shall advise subjects that these will be explained fully by the examiner. Subjects may be advised of the following:

- the examination is voluntary, unless otherwise provided by this policy in cases of internal investigations;
- results of the examination are not acceptable in a court of law; and
- results of the examination, taken alone, do not provide substantiation for a criminal charge.

Should the subject be late for or cancel the appointment, the requesting officer shall immediately notify the examiner.

If possible, the requesting officer shall report, with the subject and any other authorized persons such as attorneys, parents, or legal guardians, to the examination location. The examiner shall be solely responsible for authorizing the presence of any person inside the examination or observation rooms.



## 4-709.5 EXAMINER'S RESPONSIBILITIES

After receiving a test case from the supervisor and reviewing the documentation, the examiner will make the final determination on whether the case is suitable for an examination. If so, the examiner will coordinate with the requesting officer to ensure a thorough examination is completed. If scheduling conflicts exist, the examiner, in conjunction with the supervisor, will reschedule the examination to accommodate the subject's and examiner's schedule.

When conducting an examination as part of a pre-employment investigation of a candidate for a sworn or civilian position in the Agency, the examiner will ensure that candidates are provided with a list of areas from which polygraph questions will be drawn, prior to the examination.

Once an examination is complete, the examiner shall complete the Truth Verification Information Packet Form #959, indicating the result of the exam. The examiner will also complete a final report on the Polygraph Examination Report Form #784 and forward it to the Supervisor, Truth Verification Function.

For all criminal examinations, the examiner will complete a supplemental report to the investigative case file documenting the following information:

- date and time of examination;
- names of examinee and examiner;
- all relevant facts learned during examination; and
- examination results.



## Administrative and Operational Manual

September 12, 2022

## 4-710 NOTIFICATION OF SERIOUS INCIDENTS OR UNUSUAL OCCURRENCES

The Sheriff, Assistant Sheriffs, Criminal Investigations Commander and other appropriate commanders will be notified when their personnel are involved in the following incidents.

Notification is to be made by the on-duty commander, supervisor or senior officer:

- Homicides;
- Suicides of public officials or people of notoriety;
- Arrest of public figures or members of their families;
- Robberies of large amounts of money, e.g., \$25,000;
- Robberies with serious shootings;
- Kidnapping of public figures;
- Kidnapping with ransom;
- Extortion of excessive amounts of money or of public figures;
- Shooting of a police officer or shooting by a police officer;
- Arrest of an Agency police officer;
- Force necessary in making an arrest where suspect is hospitalized;
- Escapes;
- Whenever a member of the Agency is hospitalized by means of an on-duty incident;
- Threats against life of public official;
- major disaster;
- Unusual occurrences;
- Occurrences at the Detention Center.

## 4-711 CANINE (K-9) OPERATIONS

The primary objective or mission of the K-9 Team is to provide line support to members of the Agency utilizing specially trained and highly mobile police K-9 dogs. The police K-9 can be particularly effective for:

- locating and apprehending individuals suspected of committing certain crimes;
- aiding in the search for missing persons, articles and evidence of criminal activity;
- building searches;
- crowd control;
- detecting the presence of explosives and illicit drugs;
- providing assistance in the service of certain warrants;
- promoting community relations;
- highly visible canine patrol as a means to deter criminal activity; and
- safeguarding police officers in the performance of certain duties.

### 4-711.1 DEFINITIONS

**Police Canine (K-9) Dog** - a canine typically recognized for its ability in serving the law enforcement community.

**Police Patrol Dog** - a police working dog utilized to aid patrol officers in their law enforcement duties and field operations.

**Canine Handler** - an individual charged with the responsibility of utilizing a police working dog in the performance of his duties and attending to that dog at all times.



Administrative and Operational Manual

September 12, 2022

**Canine Team** - comprised of the Canine Handler and a specially trained police K-9 dog.

**Canine Supervisor** - a sworn member of this Agency, with the rank of Sergeant or above, assigned to oversee the administration and operations of the K-9 Unit.

**Cross Trained Canine** - a police working dog that has been trained for both routine patrol operations, and for special situations such as the detection of drugs, weapons, or explosives.

**Dog Bite** - any injury or wound inflicted by the mouth of a dog, whether accidentally or intentionally, to a human being. A breaking, puncture or tearing of the skin of the victim, need not be present to be considered a dog bite, as long as there is visual indication as to where the animal inflicted the wound (teeth impression, bruise, puncture, etc).

**On-Lead** - physical attachment or connection by means of an appropriate rope, chain, strap, etc., between dog and handler for purposes of control and restraint.

**Off-Lead** - no physical attachment or connection between the dog and handler.

**Bloodhound** – a scent discrimination/trailing canine utilized to locate people and articles when the time lapsed is beyond the capabilities of a patrol dog.

#### 4-711.2 OPERATIONAL PROCEDURES

The K-9 Unit will work a regular schedule as assigned by the Patrol shift commander. Its members shall respond to requests for service from other Agency units.

The patrol duty hours of the officers assigned to the K-9 Unit will be as assigned by the shift commander and will be dependent upon the overall needs of the Agency.

In justifying the use of a police K-9, the handler shall have sufficient information, based upon facts and circumstances made available at the time, which would lead him / her to believe, as a reasonable and prudent law enforcement officer, that the use of the K-9 dog is appropriate and authorized.

The decision of the K-9 officer to use his dog in any situation is a serious decision. K-9 officers must be mindful of their duties to perform the police mission, along with using the K-9 dog in the areas for which it has been trained. The actions of the K-9 can be justified only by the facts which are known to the K-9 officer at the time they participate in those actions.

In all cases involving the deployment of the K-9 dog, the handler will make the final decision as to how and if the dog will be utilized. This responsibility may be superseded only if a supervisor / commander takes charge of the scene.

When a K-9 dog is released off-lead to apprehend a fleeing suspect, due care and judgment must be used to ensure against injury to innocent persons.

Under no circumstances is a K-9 dog to be released off-lead for apprehension purposes in crowded areas, or when other persons and/or police officers are in, or near, the path of the fleeing suspect. In addition, extremely close attention should be given to possible injury to the K-9 dog by vehicular traffic on streets and highways.

Whenever a canine report is completed for any incident where an investigative report number is assigned, a copy of the canine report shall be forwarded like any other supplement and included in the case file.



## Administrative and Operational Manual

September 12, 2022

### 4-711.3 K-9 PATROL DUTIES

No K-9 team will be detailed to work any assignment that might interfere with them being available to respond to requests for K-9 services. The following duties will not be performed by K-9 officers, without the prior approval of the K-9 Supervisor, North / South Patrol Division Commander, or other supervisor / commander:

- Transportation of prisoners.
- Traffic crash investigation.
- Any function which involves placing non-Agency personnel in the K-9 vehicle.

### 4-711.4 SPECIAL ASSIGNMENTS

All requests for special assignments; i.e., demonstrations, Executive Protection details, etc., will be made through the K-9 Supervisor or the Field Operations Commander. Requests for demonstrations must be made in writing.

### 4-711.5 ON-CALL RESPONSIBILITIES

The decision to call out a K-9 team during off-duty hours shall only be made by an on-duty supervisor or commander and coordinated through the K-9 Supervisor.

When an off-duty K-9 Unit member is contacted and is legitimately unable to respond, the next available K-9 officer will then be utilized.

If no K-9 Unit member can be contacted to respond to assist, the K-9 Supervisor or shift commander will be notified.

### 4-711.6 PROCEDURES FOR AGENCY PERSONNEL ASSOCIATED WITH K-9 OPERATIONS

#### Officer Safety

- Officers should not attempt to approach a K-9 dog or make contact with the animal without the permission of the K-9 handler.
- The fact that an officer is attired in a uniform similar to that of the K-9 handler does not render that officer immune from a K-9 bite and/or attack.
- Sudden movement, particularly hand motions or running, can prompt a K-9 to aggression. If a suspect is fleeing and the police K-9 is released, officers in the area should remain calm and motionless while the dog targets the person who is attempting to escape apprehension.
- If attacked by a K-9 dog officers should attempt to restrict movement as much as possible until the K-9 handler is able to remove the dog. Resistance or offensive gestures by a hostile victim can provoke the animal to a further degree of aggression.

#### Crime Scenes

The police K-9 can be an invaluable tool on the scene of various crimes. In order for the K-9 team to function to its potential, it is essential that the area in and around the scene of a crime be free of further contamination by responding personnel. The following factors should always be considered at the scene of any incident where a police K-9 will be utilized:

- A dog works primarily by scent. Simply being in the area will create additional scents which will further complicate the task of the K-9.

**Administrative and Operational Manual****September 12, 2022**

- Exhaust fumes from vehicle engines will cause contamination to an area where the K-9 is working and retards the K-9's ability to utilize his sense of smell.
- Whenever a K-9 officer arrives on the scene of any incident where his services have been requested, certain information should be provided to him as follows:
  - Type of crime or incident.
  - What charges are likely to be placed against the suspect.
  - Description of suspect(s).
  - Precise location and time where the suspect(s) was last observed.
  - Type of weapon(s).
- When requesting a K-9 team for a building search, officers should remain outside of the building until the arrival of the K-9 team.
- Whenever a suspect has exited a vehicle, the following details should be remembered if a K-9 team is to be used:
  - Do not enter the vehicle unless absolutely necessary.
  - If the engine is running, approach the vehicle from the opposite side of the bailout and turn it off.
  - During darkness, mark the spot where the fleeing suspect was last observed with a spotlight.
  - Do not disturb any clothing or articles which may have been discarded, lost or left behind by the suspect. Make the K-9 handler aware of these items if present.

**4-711.7 ARREST/APPREHENSION PROCEDURES**

When a K-9 team responds to assist an officer, and is able to locate and apprehend a violator, the apprehended suspect will be turned over to the officer, who will make the arrest and complete the necessary charging documents. When a K-9 officer observes a criminal violation and makes the arrest, a patrol officer will transport the suspect. The K-9 member will complete all the necessary charging documents.

In the event a K-9 officer makes an arrest and the suspect is injured, whether from the use of physical force or the use of the K-9, that member shall immediately notify the K-9 Supervisor if available, or a patrol supervisor if the K-9 Supervisor is not available. The K-9 Supervisor or the patrol supervisor will ensure that all necessary reports are completed and forwarded to the shift commander as soon as possible.

The K-9 handler shall seek appropriate medical attention for the injured suspect through either a hospital facility or the medical staff at the Charles County Detention Center. All injuries as a result of a K-9 apprehension shall be photographed.

**4-711.8 REQUESTS FROM OUTSIDE AGENCIES FOR K-9 ASSISTANCE**

All requests from other agencies for K-9 assistance shall be approved by the K-9 supervisor or shift commander. If one of these commanders is not available, then approval will be by the appropriate on-duty commander / supervisor. Where appropriate, assistance will be provided in accordance with guidelines in the various mutual aid agreements or Memorandums of Understanding (MOU's) in the AOM.



## Administrative and Operational Manual

September 12, 2022

#### 4-711.9 USE OF ANCILLARY K-9 SUPPORT FROM NON-POLICE SOURCES

This Agency recognizes that outside resources specializing in highly trained search and rescue dogs can provide a needed service in augmenting the efforts of public safety in conducting search and rescue operations.

Services of outside search and rescue K-9 teams may be requested by authority of a command level officer. Commanders considering using outside assistance shall consult with the K-9 Supervisor or division commander, or in their absence, a Charles County Sheriff's K-9 handler who is participating in the search mission.

Civilian K-9 services shall not be utilized in the search for criminal suspects without the authorization of the Sheriff or the Assistant Sheriff of Operations.

Outside search and rescue teams who become involved in K-9 support efforts shall be required to coordinate their activities with the officer in charge at the scene and to cooperate fully with the search mission.

If at any time problems or conflicts develop between this Agency and members of any outside K-9 search and rescue group, the OIC shall immediately attempt to resolve the conflict. If unable to resolve the problem, the search and rescue team(s) shall be directed to cease any further actions and vacate the scene. A report of any such incident shall be prepared and forwarded to the Sheriff within 24 hours..

#### 4-711.10 RETIREMENT AND ADOPTION OF K-9 DOGS

When the decision is made to retire any K-9, the handler may submit a request to the Sheriff to adopt the K-9. The request shall be in writing and submitted through the officer's chain of command. Along with the request, the handler shall submit a completed and signed K-9 Adoption Agreement Form #131. The form releases the Charles County Sheriff's Office from any liability for the K-9. Upon the Sheriff's approval, reimbursements as outlined in the K-9 Adoption Agreement and AOM 3-606 shall begin.

#### 4-712 HONOR GUARD

The Honor Guard was formed specifically to assist families of fallen officers at funerals when requested. The Honor Guard also serves as a community relations link by performing at various functions in and out of Charles County. The Honor Guard is comprised of sworn / correctional officers who represent the Agency at designated functions. Their operation will be in compliance with this document and any Unit SOPs. These requirements are essential due to the high visibility of the Honor Guard by the public and the image portrayed.

Members of the Honor Guard may be assigned from any Division within the Agency consistent with this policy. However, the Honor Guard is a segment of the Special Operations Division for organizational and command purposes.

##### 4-712.1 DEFINITIONS

**Honor Guard** - Generally a five member team, the Honor Guard is comprised of two Guards bearing rifles and three Color Bearers. The size of the team and duties of its members will vary according to the specific detail.

**Alternate Honor Guard Members** - There will be five alternate members who will be capable of performing as either Guards or Color Bearers.

**Honor Guard Unit** - Is comprised of the members of the Honor Guard and the Alternate Honor Guard members.

**Details** - Each Honor Guard performance will be termed as a "detail." Performances will be authorized by the Sheriff, an Assistant Sheriff, Patrol operations commander, or Honor Guard Commander. Performances generally





---

include parades, funerals, opening ceremonies, graduations, and other appropriate functions.



## Administrative and Operational Manual

September 12, 2022

## 4-712.2 EQUIPMENT

The following equipment will be supplied to the Honor Guard:

- 2 Military Rifles
- 4 flag staffs
- 4 flag staff ornaments (brass in color)
  - Eagle
  - Bottony Cross
  - Spear Point (2)
- 4 flags, 3' x 5', nylon
  - United States of America
  - Maryland State
  - Charles County
  - Charles County Sheriff's Office
- 4 flag tassels and cords. Golden yellow in color, with 5" tassels and 9' cords. Each flag staff will have one flag and one flag tassel and cord attached to it.
- 4 flag carrying harnesses, black in color, of either patent leather-type material, Clarino, or high quality cotton material.

## 4-712.3 UNIFORMS

It shall be the responsibility of the officers selected for duty with the Honor Guard to maintain all uniforms and accouterments in a condition of high readiness. Particular attention must be paid to pressing, polishing and cleanliness, with a superior military appearance being the required state.

A supplemental issue of uniforms and equipment will be made to members of the Honor Guard.

## 4-712.4 SELECTION

Officers selected for this assignment will be on a volunteer basis. When vacancies occur, a notice soliciting volunteers will be posted throughout the Agency, including a closing date. All volunteers will be formally interviewed by a selection board. The selection board will be comprised of three sworn and/or correctional officers of this Agency, one of which will be the Honor Guard Commander. The other two board members will be designated by the Special Operations Division Commander in coordination with the Director, Corrections Division.

The board's decision will be based on the following selection criteria:

- Has consistently demonstrated a sharp military appearance.
- Has consistently exhibited self-discipline, initiative, and a positive demeanor.
- Appearance before the selection board.



**Administrative and Operational Manual**

**September 12, 2022**

**4-712.5 HONOR GUARD COMMANDER**

The Honor Guard Commander is a duty assigned to the Commander, Community Services. The Honor Guard Commander will receive and review requests for the Honor Guard, and shall have authority to approve or deny these requests. The Honor Guard Commander will be assisted by the Honor Guard Coordinator as defined within this policy.

**4-712.6 HONOR GUARD COORDINATOR**

The Honor Guard Coordinator will be of the rank of Sergeant. The Coordinator will report directly to the Honor Guard Commander, in all related matters. The Coordinator will be responsible for the training of members, scheduling of approved details, keeping of related records, and maintenance and custody of related equipment.

The Coordinator will be responsible for the submission of overtime slips and will maintain annual records on time used and functions attended.

**4-712.7 HONOR GUARD TRAINING**

The Honor Guard Coordinator will schedule and conduct all requisite training. At the minimum, training will be conducted on a quarterly basis. Prior to the performance of a detail, the Coordinator may schedule a training session.

**4-712.8 REQUESTS FOR PERFORMANCE**

All requests for performances by the Honor Guard will be submitted to the Honor Guard Commander, who will have responsibility for approval. Upon approval of the detail, the Commander will forward the request to the Honor Guard Coordinator, who will complete an appropriate Special Activity Report Form #758 listing all pertinent information. Regardless of whether the request is approved or not, the Commander will inform the requestor of his decision.



## Administrative and Operational Manual

September 12, 2022

## 4-714 MEDICAL CANNABIS (MARIJUANA)

The State of Maryland passed a law effective October 1, 2013, which legalized the possession of marijuana for authorized medical purposes. By doing so, the State has made marijuana fall into one of three categories:

- **Legal:** specifically designated as medical marijuana and possessed by an authorized person registered with the State;
- **Non-Criminal:** small amounts of non-medical marijuana or medical marijuana possessed by an unauthorized person, currently less than 10 grams. Violations are civil offenses only;
- **Criminal:**
  - 10 grams or more of non-medical marijuana; or
  - medical marijuana possessed by an unauthorized person; or
  - possession of medical marijuana in a quantity more than permitted; or
  - possession of any type of marijuana with the intent to distribute.

Although the Sheriff's Office does not routinely enforce federal laws, it is important to remember that possession of any amount of marijuana and for any reason is still a violation of federal statutes.

The State has created the Maryland Medical Cannabis Commission (MMCC) to oversee and regulate the medical marijuana laws. This law creates several classes within the process of delivering medical marijuana to the patients:

**Growing Operations:** Designated people and locations specifically authorized to grow marijuana for dispensing purposes only. (Green ID Cards)

**Processors:** Specific people and locations designated and approved to process the raw marijuana into forms which are authorized for use as medical marijuana. (Blue ID Cards)

**Transporters:** These are designated people who are authorized to transport large quantities of marijuana from growing operations to the processors and then from the processors to the dispensaries. (Must have a Transportation Manifest)

**Dispensary:** A location approved through the MMCC to dispense many different forms of marijuana to either patients or caregivers with approved MMCC prescriptions.

**Patients:** People who have registered with the MMCC as qualifying patients. Only those who have registered with MMCC as patients may legally use any of the many forms of medical marijuana.

**Caregivers:** People who have registered with MMCC as persons responsible for supplying medical marijuana to registered patients. Each patient may have up to two caregivers. A person may be considered a caregiver for up to five patients.

**Prescriber:** Registered with the MMCC as a medical professional authorized to examine a patient and prescribe medical marijuana for a qualifying condition.

### 4-714.1 CCSO EMPLOYEES AS PATIENTS OR CAREGIVERS

Employees are prohibited from possessing any form of marijuana while on or off duty, except in the performance of their duties. Therefore, no employee may be registered as a patient or caregiver with the Maryland Medical Cannabis Commission. No employee may own or work at a growing location, processing center, or dispensary



## Administrative and Operational Manual

September 12, 2022

center in any capacity or act as a transporter of medical marijuana.

If any employee's spouse or other family member is registered with the MMCC as either a patient or a caregiver, that employee must remember that their possession, either direct or constructive, may be a violation of this policy and federal law. Under no circumstance will medical marijuana be allowed into an Agency vehicle or facility except while in the performance of official duties.

#### 4-714.2 CONTACT WITH REGISTERED MEDICAL CANNABIS PATIENTS

Officers will come in contact with persons in possession of some form of marijuana who will claim to be registered as Medical Cannabis patients or registered as a caregiver with the MMCC. In these instances, the officer must make a determination whether the person is in lawful or unlawful possession of the marijuana. The law states that no person who is a registered patient or caregiver may be subject to arrest for possession of or use of medical marijuana as long as they are in compliance with the law.

When an officer has contact with a person in possession of marijuana and they are claiming to be registered with the MMCC, the officer will request a companion event be initiated to document the contact. The companion event will be classified as a "Medical Cannabis Contact" and will document whether there was a criminal or civil violation as well as whether there was a violation of Medical Cannabis COMAR regulations.

Prior to Maryland establishing the Medical Cannabis law, the courts had ruled that the odor of marijuana in and of itself would be sufficient probable cause to believe that there was a criminal violation and that someone in a vehicle was in possession of marijuana. This would then allow an officer to remove the occupants of a vehicle and conduct a warrantless search of the vehicle based on the odor. Likewise, a positive hit during a K-9 scan of a vehicle would produce the same level of probable cause and justify a warrantless search.

There are two things the officer must determine when deciding whether the person is qualified to possess or use the marijuana lawfully:

- Is the person registered with the MMCC as a qualifying person?
  - Patient
  - Caregiver
  - Transporter
  - Distributor
- Is the marijuana classified as Medical Cannabis?

If either of these answers is no, the person is not in lawful possession and can be dealt with either criminally or civilly as the law allows depending upon the amount of marijuana being possessed.

To determine if the person is registered as one of the qualifying persons, the officers can use the person's MMCC registration number to run through the MMCC database. This database will provide the name of each qualifying person as well as their class (patient, caregiver, etc.).

#### 4-714.3 DETERMINING VALID REGISTRATION

Persons registered as patients must have a registration number; however, they are not required to carry proof of registration or required to provide the registration number. The number could be obtained from the marijuana packaging. The registration number must be on the marijuana packaging when the patient gets it from the dispensary or caregiver; however, there is no requirement that the patient keep the medical marijuana in that packaging. This all means it may be very difficult to determine if someone is an actual registered patient or not. If the person is claiming to be a registered patient, but cannot provide any proof, the officer will be left with normal



Administrative and Operational Manual

September 12, 2022

questioning of the facts and circumstances surrounding the possession and will have to articulate how they determined the person was either not a patient or the marijuana was not medical prior to taking enforcement action. Anyone registered as a transporter, caregiver, or dispenser must have proof of their registration on their person. This makes it much easier to determine that the person in possession of the marijuana is registered and can legally possess medical marijuana. If they are unable to provide proof of registration with the MMCC, any possession of marijuana will be considered unlawful.

[REDACTED]

### 4-714.5 VIOLATIONS OF MMCC COMAR REGULATIONS

When registering as a Medical Cannabis patient or caregiver, the person agrees to adhere to certain COMAR regulations. Violations of these regulations may result in them losing their registration qualifications; however, an officer may not take any specific action as a result of the violation of these regulations. The COMAR regulations state that a person may not:

- Smoke medical marijuana in public;
- Smoke medical marijuana in a car;
- Smoke medical marijuana on private property where a landlord does not allow it;
- Operate a vehicle, boat, or plane while under the influence of medical marijuana;
- Perform “any task under the influence of marijuana or cannabis, when doing so would constitute negligence or professional malpractice.”

For purposes of these regulations, COMAR states “Vaping” is not the same thing as “smoking;” therefore, vaping of medical marijuana in public is legal.

If the person is in compliance with the law, but is in violation of the one of the COMAR regulations, the officer will prepare a written incident report detailing the violation. The incident report number will be generated from the Companion Event created for the contact. This report will be sent by Records to the MMCC who will then investigate the violation and determine if the person’s registration should be revoked. This report should contain:

- the date, time, and location of the incident;
- the violator’s name, DOB, and address;
- the violator’s MMCC registration number, and registration class;
- the violation observed.

If the violator is a caregiver, the officer should confiscate their registration card and note the confiscation in the report. The card will then be forwarded to Records, who will send it to the MMCC along with the report.

Records will also send a copy of each report to the Commander, Narcotics Enforcement Section and the Agency General Counsel.

### 4-714.6 SEIZURE OF MEDICAL MARIJUANA

If an officer determined the person was in unlawful possession of marijuana and therefore seizes it as contraband,



Administrative and Operational Manual

September 12, 2022

the marijuana will be handled and packaged in accordance with CDS packaging requirements elsewhere in the AOM. If it is later determined the marijuana was medical grade and the person was in legal possession of it, the marijuana may not be returned to the owner. Even though the possession of the marijuana may be legal by way of statute in the State of Maryland, the possession of the marijuana would still be unlawful on a federal level and therefore the Agency will not return the marijuana in violation of federal law.

#### 4-714.7 FIREARMS

Possession of marijuana is still considered a violation of federal law. However, if the holder of a MMCC card already owns / possesses firearms, the Charles County Sheriff's Office will not take steps to go out and seize those firearms.

If a subject has a MMCC card, they are NOT permitted to purchase or take possession of any firearms. They can, however, transfer firearms to others.

If a MMCC card holder has any firearms seized by a law enforcement officer, they cannot be returned until any prohibiting factors have been resolved:

- the MMCC card holder has surrendered and provides proof of the deactivation of the card;
- proof would include MMCC providing them a receipt showing they deactivated the card;
- additionally, they are not eligible again until 1 year has elapsed since the deactivation of the card and 1 year has elapsed from their last admitted use of cannabis

As for caregivers, if they are not prohibited for another reason; criminal, mental health, etc., they would be treated as any other citizen with regard to purchase and possession of firearms.



## Administrative and Operational Manual

September 12, 2022

## 4-715 BURGLARY

The crime of burglary defiles one of the basic securities of our society. As a result of this crime, the home or otherwise secure area of a person is invaded by another, whose purpose is to take something or harm the owner. It is therefore imperative that a law enforcement agency protect its citizens from the threat and occurrence of such crimes. Failing prevention, law enforcement personnel must take all possible steps to apprehend and present for prosecution those who commit these crimes.

Officers of this Agency are required to patrol neighborhoods for daytime burglaries. When officers are not on call they should devote some part of their preventive patrol to the prevention of this crime and the apprehension of those who perpetrate it.

In the night and at other times when business and other storage areas are not occupied, officers will regularly check these places for security. Officers will drive completely around such places using the vehicle spotlight to illuminate dark areas. In cases where it is impractical to drive around the location, the officer will leave his vehicle and walk around using his flashlight to ensure that things are secure. Officers are encouraged to get out of their vehicles to check doors for security, even when it is possible to drive completely around structures.

### 4-715.1 PATROL OFFICERS' RESPONSIBILITIES

It shall be the responsibility of patrol officers who are assigned to respond to a call involving burglary to complete the following:

- an initial report will be made detailing the facts and circumstances surrounding the crime; and
- any witness to the crime will be located and information concerning the identification of that witness and the knowledge of the crime he may have will be noted in the initial report; and
- a list of the property taken will be entered into the report, including a description and any identifying numbers or markings; and
- any evidence left at the scene by the perpetrator will be collected and/or photographed; and
- the scene will be processed for latent fingerprints and any found prints will be lifted and preserved as evidence; and
- if time permits, a limited neighborhood canvass for witnesses and information concerning the crime will be made; and
- the officer will conduct a cursory security survey of the premises and suggest ways to make it more secure from future burglaries, referring the complainant to Agency crime prevention resources for more in-depth help in this regard.

Officers should not promise the assignment of a detective nor give a specific reference to a time when the complainant will be contacted by Criminal Investigations. The officer will coordinate with Criminal Investigations as necessary to solve the crime and prevent reoccurrences in the officer's patrol area. Officers should make themselves aware of burglary patterns within their patrol area and use such information and suspect information in their preventive patrol.





---

## **4-715.2 CRIMINAL INVESTIGATIONS' RESPONSIBILITIES**

The Commander of Criminal Investigations will ensure that trends in burglaries are communicated to the patrol officers who may be affected by those trends. He will require investigators to attend patrol roll calls from time to time to discuss burglaries with patrol officers and provide information concerning suspects who may be operating in a given patrol area. Investigators should be aware that cooperation between patrol officers and investigators is essential to effective control of the crime of burglary. Patrol officers can many times provide the arrest or other information which will close strings of burglaries.

## **4-715.3 SUPERVISOR'S RESPONSIBILITIES**

Patrol supervisors will be aware of burglary trends within their area of patrol responsibility and will deploy their personnel, to the degree possible, in response to outbreaks of burglaries. The patrol supervisor will work closely with Criminal Investigations investigators to ensure that available information is disseminated to patrol officers to aid in prevention and apprehension. Supervisors, when not engaged in another task, will attempt to respond to scenes of burglaries with their subordinates.



Administrative and Operational Manual

September 12, 2022

**BURGLARY - Annotated Code of Maryland**

(Quick Reference)

<b>Burglary</b> (Section 29)	Break and enter the dwelling of another with the intent to commit:
	1) a theft, or
<b>First Degree</b>	2) crime of violence.
Penalty: 20 yrs	

<b>Burglary</b> (Section 30)	Break and enter the storehouse of another with the intent to:
	1) commit a theft, or
<b>Second Degree</b>	2) commit a crime of violence, or
Penalty: 20 yrs (4)	3) commit an arson in the second degree, or
15 yrs & \$10,000 (1,2 & 3)	4) steal, take, or carry away a firearm.

<b>Burglary</b> (Section 31)	Break and enter the dwelling of another with the intent to:
	1) commit any crime.
<b>Third Degree</b>	
Penalty: 10 yrs	

<b>Burglary</b> (Section 32)	A person may not:
	1) break and enter the dwelling of another, nor
<b>Fourth Degree</b>	2) break and enter the storehouse of another, nor
Penalty: 3 Yrs.	3) be in or on the dwelling or storehouse of another or any yard, garden, or other area belonging to the dwelling or store house of another with the intent to commit theft, nor (see note 1)
	4) possess burglar's tools with the intent to use or permit the use of the tools in the commission of any violation of this subheading.

<b>Burglary</b> (Section 33)	Commits burglary in the first, second, or third degree and then and there:
<b>with explosives</b>	1) opens or attempts to open any vault, safe, or other secure repository with an explosive.
Penalty: 20 Yrs. (see note 2)	

<b>Breaking</b> (Section 34)	Break and enter a research facility with the intent to:
<b>research facility</b>	1) obtain unauthorized control over research property, or
Penalty: 5 Yrs & \$5,000	2) alter or eradicate research property, or
	3) damage, deface, or move in a manner intended to cause harm to research property, or destroy or remove research property, or
	4) engage in conduct that results in the removal of research property; and
the action was taken without the permission of the research facility.	

<b>Breaking</b> (Section 35)	A person may not:
<b>motor vehicles</b>	1) possess burglar's tools with the intent to use or permit the use in the B & E of a motor vehicle
Penalty: 3 Yrs	2) be in or on a motor vehicle with the intent to commit a theft of the vehicle or property in it.

**Notes:** 1) A person may not be convicted of theft and this section for the same acts.  
 2) A sentence imposed for this section may be in addition to that for the burglary.  
 3) If a building or structure is divided into separately owned or leased units, each unit may not be considered a separate dwelling or storehouse for purposes of prosecution under this subheading unless it is objectively apparent that each unit constitutes a separate dwelling or storehouse. (Section 35A)

(Definitions on reverse)



Administrative and Operational Manual

September 12, 2022

**DEFINITIONS**

**Burglar's tools** - Means a picklock, key, crowbar, prybar, jack, bit, nitroglycerine, dynamite, gunpowder, or other explosive material, an acetylene torch, electric arc, burning bar, thermal lance, oxygen lance, or similar device capable of burning through metal, concrete, or other solid material, or any other tool, instrument, or device that has been adapted, designed, or used for committing or facilitating the commission of a burglary offense.

**Crime of violence** - means abduction; arson in the first degree; kidnaping; manslaughter, except involuntary manslaughter; mayhem and maiming; murder; rape; robbery; robbery with a deadly weapon; carjacking or armed carjacking; sexual offense in the first degree; sexual offense in the second degree; use of a handgun in the commission of a felony or other crime of violence; an attempt to commit any of the aforesaid offenses; assault with intent to murder; assault with intent to rape; assault with intent to rob; assault with intent to commit a sexual offense in the first degree; and assault with intent to commit a sexual offense in the second degree.

**Enclosure** - Means any building, water craft, aircraft, trailer, sleeping car, or other structure or vehicle.

**Research** - Means any studious and serious inquiry, examination, investigation, or experimentation aimed at the discovery or accumulation of facts, data, theories, technologies, or applications for any governmental, scientific, educational, or proprietary purpose.

**Research facility** - Means any enclosure or separately secured yard, pad, pond, laboratory, pasture, or pen the purpose of which is to conduct research, house research subjects, or store supplies, records, data, prototypes, or equipment necessary to or derived from research.

**Research property** - Means any property related to research in a research facility, regardless of value, including any sample, specimen, research subject, record, data, test result, or proprietary information.



## Administrative and Operational Manual

September 12, 2022

## 4-716 CIVIL CHILD CUSTODY ORDERS

Except as discussed below, officers should not attempt to enforce civil child custody orders.

Officers must always comply with the Fourth Amendment to the United States Constitution and Article 26 of the Maryland Declaration of Rights. Officers may not enter a home without:

- Consent by one who has authority to give consent;
- Authority from a court in a warrant;
- A request from and while accompanying Child Protective Services; or
- Exigent circumstances.

These limitations on an officer's authority to enter a home apply generally as well as to child custody cases.

Officers responding to a call regarding a civil custody and/or visitation order must protect the safety of the parties, the children, and the community, and take appropriate action if a criminal violation occurs. Officers should encourage the parties to comply with the court order. Officers should not take it upon themselves to enforce the court order (for example, by removing the child from one parent's care or by taking the child from one parent's car and putting her in the other parent's car because the order gives one parent physical custody or because the visitation time is over).

Complaints that a parent is violating a court custody and visitation order need to be addressed in court by a judge. A court order may, however, explicitly direct law enforcement to take certain action. A judge may issue a **warrant** that directs law enforcement to take immediate physical custody of a child and that directs law enforcement to place the child. A child custody warrant issued by a Maryland court is valid throughout the state; a warrant issued by a judge in Garrett County is binding in Charles County, for example. An out-of-state custody order must be registered with a Maryland court to be enforceable. The Maryland court can then issue its own enforcement orders, including a warrant. Therefore, officers may not enforce any out-of-state warrant.

In addition to directing officers to take physical custody of a child, the warrant may also authorize officers to enter private property to take physical custody. The warrant may also authorize officers to make a forcible entry at any hour. Officers must comply with the Fourth Amendment to the United States Constitution and Article 26 of the Maryland Declaration of Rights. Officers, therefore, may not enter a home to take custody of a child without:

- explicit authorization from Child Protective Services;
- authorization from the court as the result of the issuance of a warrant;
- consent by a person who has authority to give consent; or
- the existence of exigent circumstances.

An interim or final protective order may also contain a provision directing law enforcement to take physical custody of a child. By statute, that order may explicitly authorize officers to "use all reasonable and necessary force to return the child to the custodial parent after service" of the order. Officers should not use force – against the respondent, the child, or anyone else – without that explicit authorization listed in the order.

Procedures for taking a child into custody in connection with a delinquency action are described in AOM 4-705.2.

Procedures relating to a missing child are in AOM 4-236.

Procedures for taking custody of a child believed to be the victim of abuse are in AOM 4-705.3.

## 4-717 KIDNAPPING



## Administrative and Operational Manual

September 12, 2022

The crime of kidnapping has three major varieties in Maryland law. There is significant overlap between them, but each is distinct. All kidnapping cases should be referred to the Criminal Investigations Division following the taking of the initial report.

#### 4-717.1 "KIDNAPPING" UNDER § 3-502 OF THE CRIMINAL LAW ARTICLE

This is kidnapping at the most basic. The crime consists of moving a person by force or fraud.

Typically, the force consists of an unlawful confinement. This section applies to victims of all ages, adults as well as children. The movement (or "asportation") must be more than incidental to another crime. For example, ordering a bank teller to the vault at gunpoint would not be kidnapping; the movement is incidental to the robbery. However, ordering the same teller into a car and driving her to another bank would be kidnapping in addition to robbery.

#### 4-717.2 "CHILD KIDNAPPING" UNDER § 3-503 OF THE CRIMINAL LAW ARTICLE

There are two parts to this statute. § 3-503(a)(2) makes it a crime to use "force or fraud" to "kidnap, steal, take, or carry away a child under the age of 16 years." The only practical difference between § 3-503(a)(2) and § 3-502 (Kidnapping) is the penalty.

§ 3-503(a)(1) involves children under the age of 12. It is a crime to forcibly abduct or to "persuade or entice" a child under the age of 12 from her home or from her custodian's custody or control. It is also a crime to "secrete or harbor" a child under 12 with the intent of keeping the child from her lawful custodian.

#### 4-717.3 KIDNAPPING BY A RELATIVE

Under the Family Law Article, it is a crime for a relative who knows that another person is the lawful custodian of the child, to do any of these following actions to a child under 16:

- Abduct, take, or carry away from the lawful custodian;
- Detain the child for more than 48 hours after the lawful custodian demands her return;
- Harbor or hide the child knowing that another relative did one of the first two items; or
- Act as an accessory to someone who has done the first, second, or third items above.

These statutes only apply to relatives. A relative is defined as a parent, grandparent, sibling, aunt or uncle, or a prior lawful custodian.

Parents are presumed to be the natural custodians of a child. In the absence of a court order, no parent enjoys greater control over the child than the other parent. In the event of a conflict over who is the lawful custodian, the most recent court custody order controls. An out-of-state custody order takes priority over a Maryland order only if the out-of-state order is more recent and the order, on its face, demonstrates that the other party either consented to the order or personally participated in the hearing. It is important to note that the out-of-state order must be registered in the Maryland court and the Maryland court must issue any enforcement of the out-of-state order.

When a report of a child or relative kidnapping is taken, the child is a missing child and, in addition to taking the initial report, the procedures outlined in AOM 4-236 must be followed.

#### 4-810 SECURITY RESPONSE VESSEL (SRV)



## Administrative and Operational Manual

September 12, 2022

The following sections establish procedures for the use, deployment and maintenance of the Charles County Sheriff's Office Security Response Vessel, hereinafter referred to as the SRV.

For radio dispatch and designation purposes, the SRV shall be referred to as "Sheriff's Boat 1" by both Police and Fire / EMS Communications.

The SRV will be trailered and stored at a central and secure site established for quick and decisive deployment when needed. The Communications Section will maintain a knowledge of the current storage location of this vessel. The vessel shall be available for use on a call-out basis, twenty-four hours a day, seven days a week.

An operational function, command responsibility for the SRV is assigned to the Commander, Field Operations Section, Special Operations Division. The crew will perform in compliance with this policy and approved SOPs established for the SRV. Personnel selected for this assignment have the specialized training, experience or other qualifications to become vessel operators or crewmen. Personnel selected will receive specialized training which prepares them to perform their responsibilities or to hone their individual skills. All training for vessel operators and crewmen will be scheduled by the Commander, Field Operations Section or a designee.

Members of the SRV function will have regular assignments throughout the Agency, but will respond to situations requiring their talents, training and expertise when the need is presented. Vessel operators and crewmen, while working a real event, will be under the temporary command of the on-scene commander of the situation or event requiring a response.

#### 4-810.1 SRV DEPLOYMENT

The primary responsibility of the SRV function is to provide waterway security patrols and maritime law enforcement on the waterways surrounding Charles County, or other duties as deemed appropriate and authorized by the Commander, Field Operations Section. They may be requested to perform the following duties:

- conduct marine security patrols, paying strict attention and detail to bridge infrastructures and privately owned and operated shoreline properties; i.e., Mirant Power Generating Plant, federal reservations;
- conduct law enforcement patrols in the waterways surrounding Charles County;
- locate, respond, and assist, when requested, to marine related lost or missing persons, overdue vessels, and vessels in distress;
- conduct search and rescue missions, when requested, and assist any other agency in search and rescue missions; i.e., U. S. Coast Guard, the Maryland Department of Natural Resources Police, Maryland Transportation Authority Police or Charles County Fire and EMS Departments;
- assist and back-up, when requested, other law enforcement agencies; i.e., federal, state, and local with any other law enforcement, and/or criminal activities for marine support;
- respond, if requested, to assist local Charles County Fire and EMS departments with any marine related fire call; i.e., boat fires, marina fires, residential and commercial waterfront fires; and
- maintain a working relationship and dialogue with Patrol Operations, Criminal Investigations Division, Special Operations Division and other operational components on matters pertaining to Homeland Security Intelligence, trends, or targets of local concern.

The decision not to deploy the vessel or to cease an operation as a consequent of obvious dangers or weather



**Administrative and Operational Manual**

**September 12, 2022**

---

conditions will be the sole responsibility of the vessel operator, who is the best informed as to individual capabilities and the vessel's safety capabilities.

The SRV function can be activated by the Commander, Special Operations Division, Commander, Field Operations Section or a designee for homeland security, surveillance, overt patrol operations, any covert operations, warrant service, assistance to allied law enforcement agencies and search and rescue activities. Unless law enforcement related, the recovery of bodies, vessels, vehicles, or other items shall be left to those agencies equipped for such operations.

The SRV function is primarily a law enforcement and homeland security tool; however, if it has been activated and an emergency rescue situation arises that is reachable prior to arrival of other rescue equipment, the Agency vessel shall respond and take appropriate action.

The SRV will deploy with a minimum of one Agency-designated vessel operator, who will not participate in the operation mission other than to operate and maintain the vessel. The SRV may deploy with one crewman in addition to the designated operator.

The Commander, Field Operations Section shall utilize only Agency approved vessel operators for deployment purposes.

Due to liability concerns and unless exigent circumstances exist, the SRV will not be used to engage in towing operations of stranded and/or disabled boats. When responding to a stranded and/or disabled vessel, the vessel may be anchored and the occupants taken to the nearest safe harbor. If towing is required and authorized by the Commander, Field Operations Section, the vessel will be towed to the nearest safe harbor or shoreline.



## Administrative and Operational Manual

September 12, 2022

## 4-900 AUTOMATED EXTERNAL DEFIBRILLATORS

An Automated External Defibrillator (AED), is an advanced medical device used by first responders and emergency medical services to deliver an electric shock through the chest wall to the heart of a cardiac patient. The AED has built-in computers which allow the device to evaluate the patient's heart rhythm and deliver a shock if necessary. Early access, CPR and defibrillation are key factors in saving victims of cardiac arrest.

The Charles County Sheriff's Office is a licensed provider through the Maryland Institute for Emergency Medical Services System (MIEMSS) and approved for two site locations for AED use. Site one is the mobile deployment of AEDs throughout the Agency, and site two is the AED located at the Waldorf Jaycees. Guidelines are established as set forth by the Medical Director of the Charles County Association of Emergency Services AED Program and Maryland Medical Protocols of MIEMSS.

As first responders, officers of the Charles County Sheriff's Office respond to medical emergencies and often arrive before any other form of advanced medical life support. The Charles County Sheriff's Office is committed to the citizens of Charles County by providing this greater level of pre-hospital cardiac care and offering support to local fire and EMS services.

### 4-900.1 DEFINITIONS

**AED:** Automated External Defibrillator.

**Agency AED Coordinator:** A sworn officer of the Charles County Sheriff's Office who operates within this policy. The Agency AED Coordinator will be trained as a layperson provider in accordance with standards set forth by the Charles County AED Program and/or the Maryland Facility AED Program, an approved training program of MIEMSS.

**BLS Providers:** Basic Life Support providers include all first responding emergency personnel, whether in hospital or out-of-hospital, and usually include those persons associated with Fire / EMS organizations and law enforcement personnel.

**ALS Providers:** Advanced Life Support providers include many first responding emergency personnel, whether in hospital or out-of-hospital, who have more advanced medical training, experience, and certifications and usually include paramedics, nurses, or physicians.

**MIEMSS:** Maryland Institute for Emergency Medical Services Systems, the state agency that will implement the new law and authorize facilities meeting the necessary requirements to participate in the AED program.

### 4-900.2 PURPOSE

This policy establishes guidelines, responsibilities, and limitations in the use of the AED by employees of the Charles County Sheriff's Office who are either sworn, civilian, or corrections staff.

An operational function, the Commanders, Patrol Operations or a designee will be responsible for selecting the Agency AED Coordinator, who shall possess program approved CPR and AED certifications. The AED Coordinator will be responsible for implementing and administering the program, maintaining records and documentation, reporting use of the AED, facilitating required inspection and maintenance of the units, and other associated program duties.

### 4-900.3 CARE AND MAINTENANCE





## Administrative and Operational Manual

September 12, 2022

Sworn officers who are assigned or possess an Agency AED while on routine patrol shall safeguard the unit from potential damage. The suggested method of transportation of the AED is to secure the unit by seatbelt or by placing the unit on the floorboard of the patrol vehicle. If the AED is maintained at a fixed facility, the unit shall be visible and accessible for immediate use.

AED units assigned to officers will be inspected and exchanged during shift change. An "OK" in black letters displayed on the LCD screen located on the handle of the unit indicates readiness. A red wrench or red battery symbol displayed indicates service required and will appear if a problem with the unit exists. If a problem code is displayed, place the unit out of service and contact the Agency AED Coordinator. The AED will remain out of service until a replacement can be obtained or the unit serviced. The AED will be thoroughly inspected once per week, using a Maintenance Check Sheet assigned to the unit. Any missing equipment will be replaced immediately by contacting the AED Coordinator. Completed inspection sheets will be turned in to and retained by the Agency AED Coordinator for a period of five (5) years.

#### 4-900.4 DEPLOYMENT PROTOCOL

Agency care givers shall deploy the AED utilizing the specific guidelines and training provided.

**NOTE:** Cardiac arrest secondary to trauma is not treated according to this protocol. In trauma situations, transport should be rapid with CPR by BLS / ALS providers.

#### 4-900.5 REPORTING PROCEDURES

Whenever an AED unit is used, whether the patient was shocked or not, the user will adhere to the following reporting procedures.

- a Maryland Facility AED Report For Cardiac Arrest form will be completed by the care giver and forwarded to the Agency AED Coordinator before the end of the care giver's tour of duty;
- the Data Report generated from the AED memory will be attached to the Maryland Facility AED Report For Cardiac Arrest form;
- the coordinator will mail the report to the MIEMSS within 48 hours of the incident;
- in cases of death, a copy of the form will be attached to the death report completed by the officer;
- in the event of an AED malfunction, the AED Coordinator will complete a mandatory FDA medical products reporting form and submit it to the FDA.

Should the AED located at site two, the Waldorf Jaycees, be utilized during a cardiac event, the responding officer shall:

- take custody of the AED at the medical facility selected by EMS personnel;
- transport the AED unit to La Plata District Station to download the Data Report;
- return the unit to site two prior to the end of his tour of duty.

MIEMSS protocol mandates the Maryland Facility AED Report for Cardiac Arrest form should be filled out immediately after an incident by the main care giver at the scene and the AED operator, if a different person.

Should the AED be used by an employee of site two, completion of the Maryland Facility AED Report for Cardiac Arrest form is the responsibility of that employee, who will then turn over the report form to the responding CCSO officer to submit to the AED Coordinator.



## Administrative and Operational Manual

September 12, 2022

The officer will then follow the listed reporting procedures and report distribution guidelines outlined in this policy.

#### 4-900.6 REPORT DISTRIBUTION

A copy of the Maryland Facility AED Report for Cardiac Arrest form, and a copy of the AED data download will be left with the receiving emergency room hospital staff by the officer.

The original of this form, the data download, and a copy of any Report of Death will be forwarded to the AED Coordinator.

The AED Coordinator will forward a copy of the Maryland Facility AED Report for Cardiac Arrest form and a copy of the AED data download to the Agency AED Sponsoring Medical Director as well the County AED Coordinator, and MIEMSS.

#### 4-900.7 TRAINING

The Commander, Training Division will be responsible for the yearly CPR and AED training / re-certification to all sworn, correctional, and select civilian staff as required by the Maryland Facility Automated Defibrillation Program, a program of MIEMSS. They will complete the yearly American Red Cross Adult, Infant and Child CPR certification course as well the American Red Cross AED Essentials Certification as offered by the Southern Maryland Criminal Justice Academy, a course approved by MIEMSS.

#### 4-900.8 DOWNLOADING AED DATA

When the AED is utilized on a patient, normally the unit will stay with the patient during transport to a medical facility. Once an officer recovers the unit it is his responsibility to download the stored data from the AED. The only approved station to download the data is located at the La Plata District Station, squad room.

In cases where a patient was transported to a medical facility, the officer will transport the AED unit to the La Plata District Station for downloading in a timely fashion. The downloaded data and a copy of the Maryland Facility AED Report for Cardiac Arrest shall be delivered to the medical facility and left with the emergency room staff prior to the end of the officer's tour of duty.

In order to accomplish downloading data from the AED, the unit must be attached to the printer with the provided connecting cable. The operator will follow the prompts and make three (3) copies of the data for distribution. Photocopies are acceptable. Instructions for the data download are provided at the printer station as well as with the AED Coordinator.

#### 4-900.9 REQUIRED EQUIPMENT

The following listed items will be kept with the AED at all times:

- 2 sets of defibrillator chest pads;
- 1 pocket face mask;
- disposable gloves;
- 2 safety razors (for shaving patient's chest if necessary, for proper pad contact);
- 1 absorbent towel;
- 5 - 4x4 gauze pads; and



Administrative and Operational Manual

September 12, 2022

- Maryland Facility AED Report forms for Cardiac Arrests.

A ready-to-use AED should be kept in a closed, intact case with no visible signs of damage which would interfere with its use. It is the responsibility of the Agency AED Coordinator to maintain surplus supplies and ensure the policies and procedures established herein are followed by Agency personnel. Any missing or used equipment will be replaced immediately by contacting the AED Coordinator.

#### 4-900.10 QUALITY ASSURANCE

Documentation of all necessary equipment maintenance, repairs and inspections is required. Additionally, documentation of all authorized AED user personnel must be maintained. For quality purposes, the following records must be maintained:

- a log showing the dates of performance manufacturer recommended maintenance, as well the company performing the maintenance;
- repairs performed on the AED, as well the date and the company that performed the repair;
- dates and frequency of routine safety inspections of the AED, documentation of a properly functioning AED, and the individual conducting the inspections;
- documentation of all personnel authorized to operate AEDs, including dates of initial training and subsequent required refresher training, as well as current recognition from a MIEMSS approved AED training program;
- documentation showing the name, address, and telephone number of the sponsoring physician and verification the physician meets required qualifications;
- completed Maryland Facility AED Report for Cardiac Arrest form, for each incident requiring AED deployment; and
- mandatory FDA medical products reporting form in the event of an AED malfunction.

When an AED is utilized, it will be the responsibility of the Agency AED Coordinator to contact the program sponsoring physician to conduct a quality review in accordance with the quality review procedures as set forth by the facility AED Program.



## Administrative and Operational Manual

September 12, 2022

## CHAPTER 5 – AGENCY REPORTING SYSTEM

### 5-100 REPORTS AND REPORT WRITING

It is the policy of the Charles County Sheriff's Office to document incidents of many different kinds on various types of reports and forms. This is done so a permanent record of events is available for:

- criminal charges and prosecution;
- civil liability protection;
- assistance to victims and other interested parties;
- further investigation;
- reference in regards to unusual events or occurrences;
- matters of public safety / health / welfare; and
- gathering statistical information for NIBRS and other applications.

#### 5-100.1 GENERAL REPORTING PROCEDURES

The primary document controlling report writing for CCSO will be the Report Writing Guide. Officers of this Agency shall make or cause to be made, complete, detailed and accurate reports for all reportable incidents / offenses on the proper forms and in the proper formats. Additionally:

- each report will be assigned an incident or event number unique to that occurrence;
- reports shall be legibly printed in blue or black ink, typewritten, or prepared in a computerized reporting system;
- twenty-four hour military time will be used throughout all reports;
- the exact location of occurrence, including at least the hundred block designation if not the correct, complete physical address, will be recorded on the report. When appropriate and available, the town, community, subdivision, etc., will be listed;
- all reports will reflect whether or not the incident / crime occurred in "Charles County Maryland;"
- the reporting officer will affix his signature followed by his ID number (officer's last name printed legibly below or beside signature) on all reports in blue ink to distinguish photocopies from original documents;
- the incident, offense, and persons tabs of the Incident Report should be completed prior to going in-service from the call. The final report should be completed prior to the end of the tour of duty (work week) for the officer.
- in no case, without the permission of a District or shift commander, shall a report be placed "on hold" if the reporting officer does not anticipate reporting for duty the following day; e.g., days off, scheduled leave, etc.;
- all reports will contain information material to the matter
- reports will be reviewed and approved or rejected by the appropriate supervisor immediately upon completion;
- regardless of an investigation's status, supplemental reports will be completed and submitted if any



## Administrative and Operational Manual

September 12, 2022

additional information is developed;

- under no circumstances shall an employee knowingly include, or permit the inclusion of, any false, fraudulent or misleading information in any official report prepared or produced by this Agency;
- under no circumstances shall an employee knowingly exclude any information which by its omission would be misleading or fraudulent. Further, no pertinent information shall be omitted with the intent of avoiding follow-up investigation or avoiding completion of a multiple-page report; and
- If a supplemental report is generated for an incident with pending criminal charges, the officer shall notify the State's Attorney's Office that the report has been submitted. If the supplemental report includes exculpatory information, the officer will send a copy directly to the assigned prosecutor or, if no prosecutor is assigned, to the District Court or Circuit Court coordinator.

### 5-100.2 CIRCUMSTANCES NOT REQUIRING REPORTS

Not every complaint received, or call for service dispatched, requires the completion of a report. A record of the incident exists in the Agency CAD system if needed. Some incidents not requiring reports are as follows:

- complaints which are determined to be unfounded;
- incidents which are investigated in their entirety by another agency;
- calls on which the responding units are canceled prior to arrival;
- incidents for which no victim or complainant can be verified, no crime can be determined and no participants can be located; i.e., gone on arrival, unable to locate;
- events for which a police response is necessary, but the completion of a report would only duplicate statistical data already captured; i.e., routine loud music complaints, accidental / false alarms, disabled vehicles or routine disorderly conduct calls; and
- minor (vehicles operable), property-damage-only motor vehicle accidents which do not involve Agency vehicles, where an exchange of personal and insurance information is accomplished, and no other violations are present (i.e., driving while intoxicated, driving while suspended, operating an uninsured motor vehicle, driving without a license, operating an unregistered motor vehicle, etc.). (Reporting procedures for motor vehicle collisions involving Agency vehicles can be found in Section 6-600 of this Manual).

### 5-100.3 INCIDENTS REQUIRING REPORTS

Certain incidents or events necessitate the completion of a written report. Officers may become involved in or become aware of these incidents as a result of:

- citizens' reports of crimes;
- citizens' complaints;
- being dispatched or assigned to a call;
- self-initiated criminal and non-criminal cases; and/or
- incidents involving arrests, citations, or summonses.



## Administrative and Operational Manual

September 12, 2022

Dependent upon the nature, course and scope of a particular investigation, additional reports or forms may be required. Any property or evidence recovered as a result of an officer's official duties will be recorded and will require completion of an I.R., whether the property is immediately released or not. Crime Information Reports shall be completed as directed elsewhere in this Manual.

#### 5-100.4 CIRCUMSTANCES REQUIRING SPECIFIC REPORTING PROCEDURES

Some incidents by their very nature require specialized reporting procedures. Just as different incidents require varied report forms and formats, some reports require the inclusion of specific information for various purposes, compilation of statistical data or entry of stolen property in the METERS / NCIC computer system. Others necessitate procedures unique to that particular incident type. The following portion of this policy addresses some of these circumstances and requirements:

- Child / vulnerable adult / elderly abuse reports must contain the relationship between the suspect(s) and the victim(s) to establish a care, custodial or familial association.
- All missing person reports will be completed and submitted before the reporting officer secures from his shift. Supplements will be completed every seventy-two hours for a period of ten days on non-critical missing person cases. After ten days, the investigation will be forwarded to CID for follow-up. A notation will be made in the final supplement indicating contact was made with the complainant at the end of the ten-day period, and the missing person has not been located. If at any time during the initial ten-day period, information is developed indicating the missing person has left Charles County, the case will be immediately forwarded to CID for investigation. In those missing person cases deemed to be critical, an immediate notification will be made to CID.
- When a combination of offenses occurs during the same incident or continuing course of incidents, a single report will be sufficient. The incidents shall be listed with the most serious first; i.e., Homicide / Robbery, Rape / Possession of Marijuana, Burglary / Auto Theft, etc.

All reports requiring prompt METERS / NCIC entry or removal will be completed and submitted to a supervisor immediately for review and approval; i.e., juvenile / critical missing person, stolen / recovered vehicles, stolen / recovered registration plates.

All reports for stolen or recovered vehicles must contain:

- whether the vehicle was displaying the front, rear, both or no registration plates at the time of the theft or recovery;
- whether or not the vehicle has been entered in the "Watch Your Car" program; and
- if so, whether or not the vehicle is displaying the program decals.

All reports in which a suspect has been developed and are being closed with no charges shall contain the following wording:

- "On (date) I spoke with (name of prosecutor). After review of the case, (name of prosecutor) indicated based on the facts and evidence known at this time, the State's Attorney's Office would not pursue prosecution."

#### 5-100.5 REPORTING CAUTIONS

In any report form or format, there are a number of possibilities for errors to be made. Care must be taken to



## Administrative and Operational Manual

September 12, 2022

recognize this and every effort made to avoid mistakes. Most reports rejected by Records Management are due to insufficient or inaccurate information. Recognizing that the reviewing supervisor may not be the last person reading them, it should become the goal of each employee to prepare complete, accurate and properly formatted reports. Employees should consider their reports may be, and often are read by:

- accused individuals;
- defense attorneys;
- state's attorneys;
- judges;
- insurance companies;
- investigators from this and allied agencies;
- command staff officers;
- victims; and
- members of the public, including news media.

Commonly made mistakes and problem areas include:

- improperly transcribing incident numbers;
- incorrect offense / incident types;
- improperly transcribing telephone numbers;
- failure to include area codes;
- improperly transcribing dates of birth;
- incomplete property descriptions;
- failure to include nature of damage to property;
- inaccurate property values;
- incorrect vehicle VIN's;
- incorrect spelling of names;
- transposing names of victims, suspects / accused, complainants and witnesses;
- missing report format captions;
- insufficient information specific to the incident type (see Section 5-100.4);
- failure to include Property Held number for property / evidence recovered;
- failure to properly designate persons as suspects or accused; and
- illegibility.

## 5-100.6 TELEPHONE / LETTER GENERATED REPORTS

Except as provided for in Section 5-110, the CCSO does not take reports generated by a telephone call or a letter. All reports are taken in person from a complainant, victim, or other reporting person. Rare exceptions may be made to this policy in those circumstances which would serve a legitimate law enforcement purpose and/or relieve some undue hardship to the victim, complainant or other reporting person if that person were required to meet personally with CCSO personnel. For this exception to occur, the approval of a supervisor (Sergeant or above in rank) must be obtained. When such approval is granted, a Patrol Operations officer will write the initial report.

Some examples which may warrant an exception are:

- the reporting person is an out-of-state resident who was passing through Charles County when the crime occurred and is currently not in or near Charles County; or
- a person who is an out-of-state resident has information concerning a serious crime having been committed or about to be committed within Charles County and the person is unable or unwilling to come



Administrative and Operational Manual

September 12, 2022

to Charles County to make a report.

When reports are made from information not received in person, the report narrative will clearly state the reporting officer was not on the crime scene and did not speak with the reporting person face-to-face. If the report was the result of a letter, the reporting officer will attempt to contact the reporting person by telephone to facilitate completion of the report. The letter will be attached to the original report.

### 5-100.7 LEGIBLE NAMES

Officers must print their last names legibly below or beside their signatures in parentheses on any official or legal documents requiring a signature, such as citations, warnings, forms, and repair orders, unless these documents are preprinted with the officer's name. The officer's ID number must also be legible. Supervisors are to ensure that both printed names and ID numbers are legible on all such documents. This policy includes all employees who may sign official and/or legal documents in the course of their duties.

## 5-110 TELEPHONE REPORTING

The Charles County Sheriff's Office will provide the service of telephone information gathering for the purpose of generating an official report. This service will be provided if the specific conditions contained in this policy are met. It is anticipated better service will be provided the public without any loss in the Agency's effectiveness in filling its role; and as a result of this process, better efficiency in the use of resources will be realized.

### 5-110.1 ORGANIZATIONAL POSITIONING

The Telephone Reporting Function will be activated at the discretion of the Sheriff or his designee, and will be assigned to the Commander, South Patrol Division. When activated, the function will be staffed by sworn personnel on modified duty or temporarily assigned to the function.

### 5-110.2 CASE CRITERIA

Absent emergency operations and without prior approval of the Sheriff or his designee, all of the following criteria must be met before a call will be handled by this function:

- The suspect must be unknown and must have left the scene; and
- The incident must have "occurred earlier;" and
- There must be no evidence left on the scene to be processed or gathered; and
- No damage to any county, state, or federal property may have occurred.

Consistent with the criteria stated in the previous paragraph, the following events may be handled through this process:

- Theft (except shoplifting);
- Vandalism (except school or place of worship);
- Indecent, threatening or annoying phone calls (unless the complainant or Agency personnel believes there to be a danger to the complainant);
- Credit card fraud (report forwarded to Financial Crimes Unit for follow-up);
- Lost property; and
- The taking of a supplemental information report for a previously reported event.



**Administrative and Operational Manual****September 12, 2022**

All requests for telephone reporting will be handled via computer terminal (requiring a CAD entry as for all other calls for service). Once the CAD entry arrives in Communications, the PCO will confirm the incident qualifies for this function, and then assign the call to be handled by the call taker.

In no case when an officer has responded to the scene of a call for service will that call be reassigned to the telephone reporting function without the approval of the officer's supervisor. For those instances, Communications will be notified to reassign the call and advised the reason for the call being reassigned to this function.

If an incident has been handled by telephone reporting, but information is developed that requires an officer to respond, the initial report will be handled by the call taker and an officer will be dispatched to the scene to assist in the incident. This might include such assistance as:

- Collecting evidence;
- Photographing damaged property; and
- Interviewing witnesses or suspects.

In these instances, the officer will prepare a supplemental report to the initial report handled by the call taker. The officer's supervisor will then determine if the officer will continue to follow up on the incident.

**5-110.3 REPORT REVIEW**

Once the officer in a telephone reporting capacity prepares a report for the incident handled, the report will be directed to the Commander, South Patrol Division for approval. When approved, the report will be forwarded to the Records Section to be filed. A copy will be sent by Records to the district commander for the district in which the incident occurred and to CID.

**5-110.4 FOLLOW-UP INVESTIGATION**

If, in the opinion of the Commander, South Patrol Division a report needs follow-up investigation, the report will be assigned to the shift commander working at the time of the original call and will be marked "follow-up recommended." In these cases, the shift commander will assign an officer in that district to the investigative follow-up and supplemental reporting as deemed necessary by the commander.

**5-110.5 PROVIDING REPORT TO COMPLAINANT**

As a courtesy to the complainant for utilizing the Agency's Telephone Reporting Function, fees associated with a Maryland Public Information Act request by the complainant for the incident report will be waived. If the complainant requests a copy, the employee taking the report will direct the complainant to the Records Management Section to make the request.

**5-110.6 SPECIAL PROVISIONS**

The Telephone Reporting Function is not permanently staffed, but can be activated based on the Agency's needs. Generally, when activated it will operate as described above. However, in some cases, officers can be assigned to the function during emergency situations or special assignments and operation of the function can be modified by special order or executive directive.

**5-150 ADMINISTRATIVE REPORTING PROGRAM**

There is established an Administrative Reporting Program to provide information to the Sheriff and others regarding

**Administrative and Operational Manual****September 12, 2022**

performance of the Agency and all its components. This program creates a number of reports which are produced on a regular basis or are triggered by an event or incident. In addition to providing tracking and analysis information of practical value in the operation of the Agency, these reports satisfy CALEA requirements which must be documented.

The Commander, Executive Services Division is responsible to oversee the Administrative Reporting Program within the Agency and all of its components. The Commander, Executive Services Division shall require, on behalf of the Sheriff, all reports be submitted on or before their respective due dates. He may use the resources of OPR to determine the information within each report is supported by documentation and processes, as may be required to complete these reports, and that all such processes are in fact being accomplished. In short, the Commander, Executive Services Division, in conjunction with the Commander, OPR and the resources of OPR, will assure that the integrity of the Administrative Reporting Program is maintained.

In addition to any other repository required for reports which meet a CALEA requirement, commanders, directors, and managers will direct a copy of all such reports to the Deputy Director, Planning & Accreditation. The Deputy Director will see these reports are filed within the associated CALEA file in a fashion which prepares the Agency to submit required CALEA reports and prepares the Agency for reaccreditation. This section of the Manual describing the Administrative Reporting Program is designed to aid commanders in fulfilling this requirement. The Commander, Executive Services Division will, on behalf of the Sheriff, assist the Deputy Director, Planning & Accreditation in collecting any reports which may become delinquent. Any such delinquent report, not justified by unusual or extreme circumstances, will be considered a serious breach of administrative and management responsibilities.

## **5-151 AGENCY ANNUAL REPORT**

Each calendar year, a comprehensive Agency Annual Report will be published outlining the activities of the Agency for the previous calendar year. This Report will be compiled by the MRO during the calendar year which it will cover. It will be subsequently published by the Agency MRO in June of the following year. The Report will:

- describe the structure of the Agency; and
- introduce the current Executive Staff; and
- explain and display the specific activities of each component of the Agency and highlight specific accomplishments;
- display summary data concerning investigations conducted by OPR in a manner designed to provide public and employee confidence that these investigations are conducted impartially with just results;
- display data concerning the number of crimes, motor vehicle crashes, incidents and activities handled by the Agency which might provide the Charles County community insight concerning the fulfillment of the responsibilities of the Office of the Sheriff; and
- such other information which will give readers an understanding of the Office of the Sheriff and its activities.

This Report will be published both within the Agency and for public information outside the Agency. Several copies of the Report will be distributed to each location of the Charles County Library and the libraries of the various public schools within the County. A copy will be given to each employee of the Charles County Sheriff. Copies of the Report will be delivered to each of the Charles County Commissioners and through the office of the County Administrator will be made available to the various offices of County Government. Additionally, through the Community Services Section, the Report will be made available to interested community groups who interact with the Agency in the various programs supported by that Section. Finally, the Report will be made available at each of the various operational offices of the Agency for public distribution and will be sent by the MRO to any interested



## Administrative and Operational Manual

September 12, 2022

party who may make a specific inquiry for a copy.

## 5-152 ANALYSIS OF AGENCY USE OF FORCE

The Commander, Office of Professional Responsibility will collect a Use of Force Report for each use of force incident as defined in this Manual. The Commander will review each incident of use of force to determine that the use of force was within the guidelines established by Agency policy and to note any need for discipline, remedial training or revision to policy.

Annually, the Commander, OPR in conjunction with the Commander, Training Division will conduct a review of Use of Force policy and lethal / less than lethal weapons training. The purpose of the review is to determine the need for any changes in training, equipment upgrades and/or policy modifications.

The Commander, OPR will complete, in April of each year, an analysis concerning the use of force by Agency personnel. This analysis will be a confidential document for distribution through the chain of command to the Sheriff. Copies will be provided to all affected members of the Executive Command Staff. No information contained in the analysis will be shared with any other outside entity without the approval of the Sheriff. The analysis will contain:

- a listing of all use of force incidents, including dates and times of incidents; and
- types of encounters resulting in use of force; and
- the final disposition of each incident which has reached a final conclusion; and
- any developing trends in use of force; and
- observations regarding the effectiveness of techniques used and recommendations regarding alternate methods which have proven more effective in similar situations; and
- any conclusions regarding the need for additional training or equipment; and
- any need for revision of policy or procedures; and
- identified individuals who may need further evaluation for developing tendencies of excessive use of force; and
- possible biases, patterns or trends developing toward any particular group or segment of the population, including related to a subject's race, age and gender; and
- developing technology which may impact the use of force or monitoring of the use of force; and
- trends or patterns resulting in injury to any person, including employees.

Within the Use of Force Analysis, the Commander, OPR will include a review of all assaults on the Agency's sworn law enforcement officers during the previous calendar year. The purpose of the review is to determine trends or patterns and to make recommendations to enhance officer safety, modifications to policy or address training issues. Assault incidents reviewed can include felony or misdemeanor charges or related charges. The review should evaluate the implications of each type of incident based on these and other criteria, including time of day, type of initial call, presence of multiple officers, or prior history of the arrestee(s).

## 5-153 GOALS AND OBJECTIVES

Each year, the commander, director or manager of each Agency component will update the goals and objectives of his respective component of the Agency. This will be accomplished by consulting with members of the component in an organized fashion over some specified period. There will be an attempt to develop consensus among the various members of the component regarding these goals and objectives. The result of this process will be reflected in the component SOP as well as in recommendations brought to the SMP Planning Conference each year. Each component, in addition to any other reporting required by policy or procedure, will supply the Deputy Director, Planning & Accreditation evidence of the accomplishment of this requirement by submission of a report in August of each year.

## 5-154 ANALYSIS OF CRIME DATA

**Administrative and Operational Manual****September 12, 2022**

In addition to any requirements established in policy or procedure, a quarterly report of crime trends will be directed to the Sheriff in January, April, July and October of each year. This report will contain an overview of crimes occurring within Charles County for the quarter ending the month before the report is due. This report will be the responsibility of the Commander, Criminal Investigations Division.

The report will contain specific data concerning the numbers of crimes in all categories of crime recorded by the Agency. It will also contain comparisons with previous data collected for similar periods which may suggest patterns or trends. The report will identify areas of the County which might benefit from special enforcement activities or additional assignment of personnel within specific components of the Agency. The report will also identify areas of the County where criminal activities may have lessened and where personnel may be drawn from for other duties. In brief, this report will provide data from which management decisions may be made for the deployment of personnel and justify any needs for additional personnel.

**5-155 ANNUAL JUDGEMENT OR SETTLEMENT REPORT**

Each year, in the month of February, the Office of General Counsel will compile a report containing a list of all use of force incidents that occurred in the previous year and involved a sworn officer, resulting in a monetary settlement or judgement against the Agency.

Per Maryland Public Safety Article 3-528, the report must contain the following information:

- The age, gender, ethnicity and race of each individual involved in the incident;
- The age, gender, ethnicity and race of the sworn officer involved in the incident;
- A brief description of the circumstances surrounding the incident, such as:
  - The date, time and location of the incident;
  - The date on which the civil action was filed;
  - The date on which the civil action was resolved; and
  - The amount of the settlement or judgement awarded to the plaintiff.

This report will be submitted through the chain of command to the Sheriff for review, prior to the required submission of the report to the Governor's Office of Crime Prevention, Youth, and Victim Services. As outlined in their procedures, this report is due by March 1<sup>st</sup> of each year. Copies will be provided to all affected members of the Executive Command Staff.

**5-156 REVIEW OF SPECIALIZED ASSIGNMENTS**

Decisions regarding the continuation of specialized assignments are important to the Agency. An annual review of all specialized assignments avoids overspecialization and ensures effective operations throughout the Agency. The Commander / Director, Administrative Services Division will maintain a current list of all specialized assignments and will review these assignments annually. The list will be updated in the Manual as needed. The review shall be designed to determine if the specialized assignment should be continued, changed or abolished.

In order to facilitate the review, each commander, administrator or manager who oversees a specialized assignment will, in December of each year, provide the Commander / Director, Administrative Services Division with an evaluation of the initial problem or condition which required the implementation of the specialized assignment, a statement of purpose for each listed assignment and a recommendation as to whether the assignment should be continued, changed or abolished. This evaluation may simply be in the form of a memorandum sent to the Commander / Director, Administrative Services Division or it may be a comprehensive development plan with supporting documentation. Such evaluation will be generated for at least each specialized assignment appearing on the Agency list of specialized assignments published by the Commander / Director, Administrative Services

**Administrative and Operational Manual****September 12, 2022**

Division and listed in this Manual.

A commander, administrator or manager may, at any time, report on changes in status, need to develop, or need to discontinue a particular specialized assignment. Such report will be sent to the Commander / Director, Administrative Services.

In April of each year, the Commander / Director, Administrative Services Division will provide a report through the chain of command to the Sheriff recommending continuation or abandonment of each specialized assignment. The report will provide justification for each such recommendation. Copies will be provided to all affected members of the Executive Command Staff. Each year, after the review process is completed, the Deputy Director, Planning & Accreditation will publish within the AOM any changes approved by the Sheriff.

**5-157 BUDGET RECOMMENDATIONS**

As described in the Agency SMP, commanders, directors and managers will supply budget recommendations to the Sheriff. These recommendations will be complete with justification, goals and objectives, and time lines for completion.

**5-158 FISCAL MANAGEMENT STATUS REPORT**

The Deputy Director, Budgeting will publish a monthly report to the Commander/Director, Administrative Services for the previous month's data, containing information for each fiscal account and budget line item. The report will include at least:

- initial appropriation for each account or program; and
- balances at the commencement of the monthly period; and
- expenditures and encumbrances made during the period; and
- unencumbered balance.

**5-159 ANALYSIS OF EMPLOYEE GRIEVANCES**

Each year an analysis of grievances filed by employees of the Agency will be conducted by the Commander / Director, Administrative Services Division. This analysis will attempt to determine any patterns which point to improvements which might be made in Agency management. The analysis will provide the basis for a report which the Commander / Director will generate and submit through the chain of command to the Sheriff in March of each year covering the period of the previous calendar year. Copies will be provided to all affected members of the Executive Command Staff.

**5-160 EMPLOYEE PERFORMANCE EVALUATION**

All employee performance evaluations will be conducted in accordance with the evaluation system developed by Human Resources Section. The system will be published in this Manual or in another fashion which assures that each employee is provided access to it.

Each employee will be evaluated at least annually. The Commander / Director, Administrative Services will, in March of each year, certify through the chain of command to the Sheriff that a performance evaluation has been completed for the previous calendar year for each permanent employee. Copies will be provided to all affected members of the Executive Command Staff.

**5-161 ENTRY LEVEL EMPLOYEE PERFORMANCE EVALUATION**

Each probationary employee's performance will be evaluated quarterly. These evaluations will be conducted in accordance with the system of evaluations developed by Human Resources Section.

**Administrative and Operational Manual****September 12, 2022**

The Human Resources Section will, on January 1 of each year, Certify to the Sheriff that these evaluations have been completed as required.

**5-162 PURSUIT REPORTS AND ANALYSIS**

Each pursuit conducted by employees of this Agency requires a report and supervisory review and critique. Each year, the Commander, OPR will cause an analysis to be made of the information gained from these reports and critiques. The analysis will seek to determine the need for changes in policy, training pursuit techniques and reporting procedures.

The Commander, OPR will submit to the Sheriff, in April of each year, a report describing the results of this analysis. Copies will be provided to all affected members of the Executive Command Staff. The report will list each pursuit by date and time of occurrence and will include for each pursuit:

- the reason for the pursuit;
- the geographical scope of the pursuit;
- Agency employees involved in the pursuit;
- any other agencies involved in the pursuit;
- injuries (or deaths) resulting from the pursuit (including those to the fleeing suspect(s) and to third parties);
- arrests made or charges placed;
- violations of policy, training, procedures or techniques by any pursuing employee or other officer;
- adequacy of policy, training, procedures or techniques to the pursuit; and
- recommendations for improvements of any kind.

**5-163 REVIEW AND EVALUATION OF JUVENILE PROGRAMS**

Annually, the Commander, School Resources Section will cause an evaluation of all enforcement and prevention programs relating to juveniles to be made. As a result of this evaluation, a report will be due in August of each year for the previous 12 months. The report will be the result of an evaluation of all juvenile programs in operation during the previous calendar year. This evaluation should consider both the quantitative and qualitative elements of each program, lending itself to decisions regarding whether a specific program should function as is, be modified, or be discontinued. To facilitate this process, the Juvenile Program Evaluation Form #125 shall be used to document a review of each program.

The report shall provide numbers of juveniles served by each program. If a program has specific clients who are targeted for a particular purpose, the evaluation and report will provide specific numbers and percentages of successes and/or lack of success in meeting program objectives.

The Commander, Special Operations Division will ensure the report is submitted through the chain of command to the Sheriff in August of each year. This report, will summarize the findings of the review and evaluation and will make such recommendations as may be supported by the information gained. This report may take whatever form is suggested by the information to be conveyed. The Assistant Sheriff of Operations will see that a review of the report is conducted in order to determine any need to restructure efforts related to juvenile programs. The Assistant Sheriff of Operations will consult with the Sheriff to determine the need to continue, discontinue or institute new programs relating to juveniles. Copies will be provided to all affected members of the Executive Command Staff.

**5-164 EVALUATION OF CRIME PREVENTION EFFECTIVENESS**

Every March, the Commander, Community Services Section will cause to be conducted an evaluation of the effectiveness of crime prevention programs. This evaluation may involve the use of citizen survey information, crime analysis information, feedback from community support organizations, or any combination of information

**Administrative and Operational Manual****September 12, 2022**

sources which provide data which proves or disproves the effectiveness of a program or individual effort. The Commander, Special Operations Division will ensure the evaluation will be submitted in writing through the chain of command to the Sheriff in March. Copies will be provided to all affected members of the Executive Command Staff.

**5-165 COMMUNITY INVOLVEMENT**

Quarterly, in January, April, July, and October, the Commander, Community Services Section will submit a report to the Sheriff, through the chain of command, containing at least the following elements:

- a description of current concerns voiced by the community; and
- a description of potential problems that have bearing on law enforcement activities within the community; and
- a statement of recommended actions that address previously identified concerns and problems; and
- a statement of progress made toward addressing previously identified concerns and problems.

The information used to support this report will be gained by the Commander and his staff meeting with citizen groups, either separately or in conjunction with the advisory groups established by the district commanders. Devices such as citizen surveys mailed to community members or follow-up questionnaires completed by patrol supervisors or members of OPR may be used. In any event, data will be used to support this report and its recommendations.

These quarterly reports will be compiled into an annual report for submission to the state of Maryland.

**5-166 CITIZENS ATTITUDES AND OPINIONS SURVEY**

Every year, a report will be completed by the Commander, Community Services Section describing the attitudes and opinions of citizens within the Charles County Sheriff's Office service area. This report will be the result of surveys conducted throughout the year. Results may also be obtained from trail audits of services provided and may occur on an individual and continuing basis. Such other methods as may prove useful in gathering data may be used.

In January of every year the Commander, Special Operations Division will ensure the report is submitted, through the chain of command, to the Sheriff. Copies will be provided to all affected members of the Executive Command Staff. The report will contain at least the following information:

- overall Agency performance;
- overall competency of Agency employees;
- citizens' perceptions of officers' attitudes and behavior;
- community concern over safety and security within the Agency's service area as a whole; and
- citizens' recommendations and suggestions for improvements.

This survey may be conducted by Agency personnel or may be done at the direction of the Agency by another entity. It may be done by mail, in person, by telephone, online or some combination of methods.

**5-167 HOSTAGE / BARRICADE AFTER ACTION REPORT**

Each hostage / barricade incident will require a report be completed by the Commander, Special Operations Division. This report will be directed, through the chain of command, to the Sheriff and will be completed as soon as practical after the conclusion of the incident, but in no case shall it take more than thirty days. The report will summarize the circumstances of the incident, describing all the participants (including law enforcement). It will display a time line for all actions and activities.



## Administrative and Operational Manual

September 12, 2022

The report will make recommendations concerning the handling of the incident, including any training or policy issues involved. An explanation of the resources used and any resources needed which were not available will be developed.

## 5-168 AFTER ACTION SPECIAL EVENT REPORT

Whenever the Agency is involved in any special event, such as the County Fair, a go-go, concert or other open air or large facility music event, plane crash, hazardous material spill and so on, the Agency Commander who has been assigned (or is currently responsible for) responsibility for the event will complete an After Action Special Event Report Form #846. The report will be completed as soon after the event as possible, but in no case will the final report be delayed more than 10 working days. If the final report is not available within 24 hours, a preliminary report will be made with as much detail as is available at that time.

If there were any significant difficulties encountered in handling the special event, an after event critique will be conducted to determine the reasons for the difficulties and to find remedies for future such events. If an after event critique is required, the division commander of the person who was in command of the Agency response to the event will conduct the after event critique. The results of this critique will be made a part of the special event report.

Special event reports will be directed to the Sheriff, with copies to the Assistant Sheriffs, all division commanders / directors, the chain of command of the employee who commanded the Agency response to the event, and to the Deputy Director, Planning & Accreditation. The Commander, Special Operations Division may develop, in conjunction with the Deputy Director, Planning & Accreditation, a standardized form for use in complying with this policy.

## 5-169 STATISTICAL SUMMARY OF INTERNAL INVESTIGATIONS

The Commander, OPR will maintain data concerning complaints received directed toward the conduct of employees of the Agency. Likewise, the Commander will maintain data concerning investigations conducted concerning the conduct of employees, whether or not those investigations resulted from complaints or otherwise.

Annually, the Commander will compile from the collected data a statistical summary which displays the following information:

- total number of internal investigations; and
- number of investigations resulting from complaints made from sources external to the Agency; and
- number of investigations generated by complaints from within the Agency; and
- number of investigations resulting in exonerated findings; and
- number of investigations resulting in sustained findings; and
- number of investigations resulting in non-sustained findings; and
- number of investigations resulting in unfounded findings; and
- comparison of these numbers with those of previous years.

This summary will be presented in writing through the chain of command to the Sheriff in April of each year covering the period of the previous calendar year. Upon approval of the Sheriff, the final approved summary will be made available to the Agency MRO for distribution to public and Agency consumers. The information will be published in the Agency Annual Report Copies will be provided to all affected members of the Executive Command Staff.

## 5-170 STAFF INSPECTION OF ORGANIZATIONAL COMPONENTS



**Administrative and Operational Manual****September 12, 2022**

In accordance with a schedule established by the Commander, OPR, an inspection of every organizational component will be conducted every four years during the month of August. The Commander, OPR will be responsible for submitting a formal report for each such inspection. The report will be directed through the chain of command to the Sheriff. Copies will be provided to all affected members of the Executive Command Staff. The copies of this report will be confidential and will not be shared except with the permission of the Sheriff.

The Commander, OPR will cause to be developed a format for conducting these inspections. This format will direct the inspection of facilities, equipment, vehicles, uniforms, personnel, files, security and operating procedures, records, publications, compliance with CALEA standards and any other facet of the component's operation which may impact its operations or readiness to fulfill its designed purpose. This format will be made as uniform as possible from component to component in order to facilitate complete and comparable inspections.

Using the established format, forms will be created to record the information gained from the inspection. The forms will be made a part of the completed report and will be submitted as a package with each report. If a form is not applicable, it will be submitted with the notation "N/A."

Before the scheduled inspection, the Commander, OPR or designee will meet with the component commander / director / manager and conduct a pre-inspection briefing. This briefing, will define the purpose of the inspection and the methods for its completion. The component commander / director / manager may share any known deficiencies and explain the cause for such deficiencies. This information will appear in the report for this inspection.

At the completion of the inspection and prior to the final report of the inspection being distributed, the draft report will be shared by the Commander, OPR or designee with the component commander / director / manager for the purpose of clarification of any issues raised as a result of the inspection. The component commander / director / manager may within 48 hours of being presented the draft report, provide any information / comments felt to be pertinent to the inspection to the Commander, OPR for inclusion in the report. The Commander, OPR will include any such information / comments with the report.

**5-171 BIAS BASED PROFILING REVIEW**

The Office of Professional Responsibility (OPR) will monitor data concerning officer contacts with citizens and filed complaints to ensure that policies concerning bias based profiling are being followed.

If information indicates an officer is engaging in bias based profiling, that officer will be closely monitored. If not the originator of the information, the officer's supervisor and division commander will be notified of the perceived problem. If a pattern of bias based profiling is clearly identified, necessary corrective measures will be taken in the form of counseling, remedial training and/or disciplinary action, up to and including termination.

Annually, the Commander, OPR will cause an administrative review of Agency practices regarding bias based profiling during the prior year to be completed. In April of each year the Commander, OPR will provide a report regarding this review through the chain of command to the Sheriff. This report will, in addition to providing the Sheriff with statistical data, identify any problems found, detail any corrective actions taken, and make recommendations for any changes in policy or training that may be needed. Copies will be provided to all affected members of the Executive Command Staff.

**5-172 REVIEW OF VICTIM / WITNESS ASSISTANCE NEEDS AND AVAILABLE SERVICES**

As a result of Agency contacts with crime victims and witnesses the Commander, Criminal Investigations Division will require a review of victim / witness assistance needs and available services within the Agency's service area to be completed by the month of April at least once every two years. This review will document victim / witness needs and services which may be met by the Agency, other government entities, private-sector organizations or community programs available for such purpose. Should there be no available method to deal with these needs,

**Administrative and Operational Manual****September 12, 2022**

suggestions for creation of feasible methods will be made if they are apparent.

This review will be developed by the Victim / Witness Coordinator, documented in writing, and maintained by the Commander, Property Crimes Section.

All of these reviews, however generated, will be directed to the Commander, Criminal Investigations Division. The Commander will assess the information as it is received and will attempt within the resources available to him / her to deal with these needs. In any case, the Commander will cause these reviews to be maintained for a period of two years.

The results of this review will be directed through the chain of command to the Sheriff, with copies to all affected members of the Executive Command Staff.

**5-173 REVIEW OF NEED FOR CROSSING GUARD**

Annually, during the month of October, the Commander, School Resource Section will prepare an annual review of crossing guard locations. The purpose of this review is to evaluate the use of crossing guards, within the restraints of available budget, at the locations needed because crossing safety might otherwise be unacceptable. Factors to be considered are the numbers, frequency of use, motor skills and relative cognitive ability of the persons using the crossing.

In cases where the Commander believes that all available crossing guards have been placed at essential locations and there are still more essential locations which need to be staffed, the Commander will provide justification for this position in the form of a budget request for additional crossing guards. In cases where the need for a particular crossing has diminished to the level where the crossing should be abandoned and there is no other need for the crossing guard, a request will be made to remove the funding for the position.

The Commander, Special Operations Division will ensure the creation of a report of this review each year is submitted to the Sheriff through the chain of command. The Commander, Special Operations Division, will use this report in preparation of the current budget request. Copies will be provided to all affected members of the Executive Command Staff.

**5-174 REPORT OF ESCAPED PRISONER**

Any time a prisoner escapes from custody, either at the scene of an arrest, while in transport, in temporary holding or otherwise, a report will be made of the circumstances of the escape. This report will be in addition to any other report required concerning the incident. The report will be made on a Commanders' Information Report and submitted before the completion of the workday for the employee having personal custody of the prisoner at the time of escape.

The employee having custody will immediately notify his supervisor of the incident. A lookout will be given to Communications for broadcast. PCOs receiving such notification will relay the information to their supervisor. All known information regarding the crimes of the escapee, identification information, transportation information and possible locations of destinations will be given.

Upon notification of an escape under this section, Communications supervisors will notify the Office of Professional Responsibility (OPR). OPR employees receiving such notification will make a determination if response to the scene is warranted. If such response is determined warranted, Communications supervisors will notify on-scene supervision / command that OPR will be responding. In any case, OPR will review each report of escape to determine the need for remedial training, change of policy or disciplinary action necessary.



## Administrative and Operational Manual

September 12, 2022

**5-175 INSPECTIONS OF TEMPORARY HOLDING AREAS**

Within any component where a temporary holding area exists, the commander of the component will cause the following inspections to occur:

- a weekly inspection for cleanliness and sanitary conditions, first aid supplies, condition of restraining devices and weapons or contraband; and
- a monthly visual inspection of fire detection / suppression equipment and fire evacuation plans;

The required weekly inspections will take place by Friday of each week and will be documented in a log kept for this purpose. The monthly inspection of fire detection / suppression equipment will be completed by the end of each month. The log will list the time and date when each inspection was conducted and the employee who conducted the inspection. Any discrepancies, weapons or contraband found will be documented. Steps taken to remedy any deficiencies discovered will also be noted.

Logs generated as a result of this process will be maintained at the local level for a period of three years. Random samples of these logs will be sent to the Deputy Director, Planning & Accreditation quarterly in January, April, July and October of each year. Each Agency audit conducted by OPR will examine these logs for compliance with this policy.

In addition to the above required documented inspections, commanders shall ensure holding areas are visually inspected daily by the midnight shift supervisor, an shift commander or other designee.

**5-177 THREAT TO HOLDING FACILITY REPORT**

Any incident which threatens a holding facility or persons therein will be documented. The documentation may be in the form of an incident report and/or a report of investigation. This report will document all information concerning the incident and will outline any steps taken to deal with the threat and prevent future occurrences.

Any recommendations for improvements in threat avoidance which are beyond the capabilities of the local command or require higher approval will be documented. Copies of these reports will be forwarded to the Sheriff, Assistant Sheriffs, Executive Services Division, Special Services Division Commander, and Office of Professional Responsibility.

**5-178 COURT SECURITY SURVEY**

At least once every two years during the month of March, a court security survey will be conducted to determine the court security function of the Agency is being properly addressed. This survey, conducted in conjunction with court personnel, will examine:

- facilities;
- equipment; and
- security plans / procedures.

The Commander, Special Services Division is responsible for this survey. The written report of this survey will be forwarded through the chain of command to the Sheriff with recommendations for any improvements or changes to be made as a result of the survey. Copies will be provided to all affected members of the Executive Command Staff.

**5-179 INSPECTION / TEST OF COMMUNICATIONS CENTER ALTERNATE POWER SOURCE**

**Administrative and Operational Manual****September 12, 2022**

An inspection and test of the alternate power source for the Agency Communications Facility will be conducted monthly, by the last day of each month. This inspection / test will be documented in writing on a log kept for this purpose, and will be maintained for three years. The Commander, Communications Section is responsible to have this inspection / test conducted. Any deficiencies discovered as a result of this inspection / test will be immediately corrected. A copy of the test / inspection log will be transmitted to Planning & Accreditation annually in January.

**5-180 AUDIT OF CENTRAL RECORDS COMPUTER SYSTEM**

An annual audit will be conducted of the Agency computer system to determine the status of passwords, access codes and access violations. This audit will determine that passwords and access codes are effective in deterring unauthorized access to systems. Any violations of authorized access will be reviewed to determine that they have been effectively dealt with and unlikely to continue.

The required audit will be documented in writing by the Director, Information Technology Division and sent through the chain of command to the Sheriff during the month of March each year. Copies will be provided to all affected members of the Executive Command Staff.

**5-181 REPORT OF CRIME SCENE PROCESSING**

The Commander, Criminal Investigations Division shall cause a report to be made of each instance where a crime scene is processed. This report will contain such information as is necessary to maintain an accurate record of events and evidence collection associated with the crime. The reports will be filed with the investigative reports associated with the crime scene.

Should the nature of the crime dictate that under Agency policy processing be accomplished by other than CID personnel, the division commander of the processing employee will require the crime scene report be completed by the processing employee. A copy of these reports will be forwarded for filing with the associated case report.

**5-182 PROPERTY REPORTS AND INSPECTION PROCEDURES**

Each time an item of property or evidence comes into the possession of personnel of the Agency a report will be written in accordance with property procedures contained in this Manual. Commanders will determine that this is happening in all cases and take any corrective action necessary to assure all procedures are being followed. The Office of Professional Responsibility will audit property procedures as a part of any component audit to determine that property is being properly reported and handled.

An annual audit of the management of property collected by the Agency will be conducted by the Office of Professional Responsibility. The results of this audit will be reported in writing through the chain of command to the Sheriff in December of each year by the Commander, Office of Professional Responsibility. Copies will be provided to all affected members of the Executive Command Staff.

Additionally, the Office of Professional Responsibility will conduct random and unannounced inspections of all property collection and handling throughout the Agency. Results of these inspections will be documented in writing and forwarded through the chain of command to the Sheriff. Copies will be provided to all affected members of the Executive Command Staff.

Semi-annually the Commander, Property Management Section will cause an inspection to be conducted to determine that all property procedures and property security measures are being properly followed. This inspection will be documented using a checklist developed by the Commander for this purpose. Copies of the checklist and any discrepancies found as a result of the inspection, as well as the steps taken to correct any discrepancies and prevent their reoccurrence will be documented and filed for a period of three years. A memorandum certifying this



## Administrative and Operational Manual

September 12, 2022

inspection has been accomplished will be sent through the chain of command to the Sheriff. This inspection will occur in January and July of each year. Copies will be provided to all affected members of the Executive Command Staff.

Any time an employee, having authorized access to any Property Held storage area, is assigned to and/or transferred, an inventory of all property will be conducted and the keys to the affected storage areas will be changed. This inventory will be conducted jointly by the Commander, Property Management Section or his designee and the newly designated property and evidence custodian under the supervision of the Office of Professional Responsibility and will be documented in writing. A report of this inventory will be forwarded through the chain of command to the Sheriff. Copies will be provided to all affected members of the Executive Command Staff.

### 5-183 SELECTIVE ENFORCEMENT REPORT

Annually, during the month of March, the Commander, Field Operations Section will create a report of the selective enforcement operations carried out by the Agency. The report will document and evaluate collision data from the past year as to location, time, and violation factors.

The report will also document the locations which were the subject of selective enforcement, and the reasons these locations were selected. The results of the selective enforcement (number of citations, equipment repair orders, arrests, etc.) will be reported. An evaluation of the effects of these activities on traffic collisions will be explained.

The Commander, Special Operations Division will ensure the completed report is sent through the chain of command to the Sheriff. The information will also be made available to the MRO for use in press releases and in the Agency Annual Report. Copies will be provided to all affected members of the Executive Command Staff.

### 5-185 EST REPORT

The Commander, Special Operations Division will submit a semiannual report that documents the activities of EST for the preceding six months. This report is due semiannually during January and July. The report will contain the following information, on a format developed by the MPTSC:

- The number of times the EST was activated and deployed by the Agency in the previous six months;
- The name of the county or municipal corporation and zip code of the location where the EST was deployed for each activation;
- The reason for each activation and deployment of the EST;
- The legal authority, including type of warrant, if any, for each activation and deployment of the EST;
- The result of each activation and deployment of the team, including:
  - the number of arrests made, if any;
  - whether property was seized;
  - whether a forcible entry was made;
  - whether a weapon was discharged by an EST member;
  - and whether a person or domestic animal was injured or killed by an EST member.

This report shall be submitted through the chain of command to the Sheriff. Copies will be provided to all affected



---

members of the Executive Command Staff.



## Administrative and Operational Manual

September 12, 2022

## 5-195 LIST OF ADMINISTRATIVE REPORTS

Report Title (AOM Citation)	Responsible Party	Purpose	Frequency	Due Date	Distribution	CALEA
Bias Based Profiling (5-171)	Commander, OPR	Documented administrative review of Agency practices regarding any potential biased based enforcement activities	Annually	April	Sheriff, Affected Members of Executive Command Staff	1.2.9
Use of Force Analysis and Review of Assault of Officers (5-152)	Commander, OPR	Analysis of Use of Force activities, policies and practices to determine needs for changes in training, equipment and/or policy modifications. Analysis will include review of all assaults on law enforcement officers to determine trends or patterns with recommendations to enhance officer safety, revise policy or address training issues.	Annually	April	Sheriff, Affected Members of Executive Command Staff	4.2.2 4.2.4 4.2.5
Annual Judgement or Settlement Report (5-155)	Office of General Counsel	A report containing a list of all use of force incidents that occurred in the previous year and involved a sworn officer, resulting in a monetary settlement or judgement against the Agency.	Annually (Compiled into an annual report for the State)	February	Sheriff, Affected Members of Executive Command Staff	
Written Agency Goals and Objectives (1-002)	Each Division Commander	Formulation of Division Goals and Objectives for upcoming fiscal year and beyond	Annually	August	Sheriff, Affected Members of Executive Command Staff, Affected Members of Command Staff	15.1.3 15.2.1 17.2.2
Staffing Assessment and Allocation Report (1-002)	Each Division Commander	Analysis of each division's manpower, workload of staffing, and allocation of current manpower	Every 4 Years (beginning 2019)	May	Sheriff, Affected Members of Executive Command Staff, Affected Members of Command Staff	21.2.4
Review of Specialized Assignments (3-602.7, 5-156)	Affected Division Commanders	Review and evaluation of each specialized assignment to determine need and continuation of the assignments	Annually	December	Commander/Director, Admin. Services	N/A
Specialized Assignments Report (3-602.7, 5-156)	Commander/Director, Admin. Services	Report on effectiveness and continued need for identified special assignments within the Agency	Annually	April	Sheriff, Affected Members of Executive Command Staff	N/A
Monthly Fiscal Status Report (5-158)	Deputy Director, Budgeting	Report of fiscal activities for all budget accounts showing balances, spending and encumbrances.	Monthly	Each Month	Commander/Director, Admin. Services	17.4.1
Cash Fund Accounts Audit Report (2-260, 3-290)	Commander, OPR	Inspection and audit of Agency cash funds	Annually	April	Sheriff, Affected Members of Executive Command Staff	17.4.2
Employee Grievances Analysis (5-159)	Commander/Director Admin. Services	Analysis of all grievances submitted by Agency employees for potential patterns or policy deficiencies	Annually	March	Sheriff, Affected Members of Executive Command Staff	22.4.3
Training Advisory Council Meeting Notes (2-812)	Commander, Training Division	Results of Training Advisory Council Meeting discussing upcoming training and identified training needs	Quarterly	Each Quarter	Sheriff, Executive Command Staff	33.1.1
Performance Evaluations Audit Report (5-160)	Commander/Director Admin. Services	Audit and certification that each employee has received at least one performance evaluation annually	Annually	March	Sheriff, Affected Members of Executive Command Staff	35.1.2
Vehicle Pursuit Analysis (5-162)	Commander, OPR	Analysis of vehicle pursuits to identify violations, deficiencies and training needs	Annually	April	Sheriff, Affected Members of Executive Command Staff	41.2.2 41.2.3
Review and Evaluation of Juvenile Programs (5-163)	Commander, SOD	Review and evaluation of all juvenile programs throughout the Agency and recommendations as to which programs should be continued, modified or discontinued as well as any recommended new programs	Annually	August	Sheriff, Affected Members of the Executive Command Staff	44.1.1 44.1.3



Administrative and Operational Manual

September 12, 2022

Crime Prevention Programs Report (5-164)	Commander, SOD	Listing of crime prevention programs and an evaluation of the effectiveness of each program	Annually	March	Sheriff, Affected Members of the Executive Command Staff	45.1.1
Citizen Survey Report (5-166)	Commander, SOD	Report of attitudes of the community regarding safety and security and the effectiveness of the Agency in addressing these areas	Annually	January	Sheriff, Affected Members of the Executive Command Staff	45.2.2
Special Events Plan	Event Commander	Operations plan for each special event, identifying the event coordinator, staffing requirements and event logistics	Each Event	10 Days Prior to the Event	Assistant Sheriff of Operations	46.2.7
Internal Investigations Statistical Summary (5-169)	Commander, OPR	Summary of complaints and internal affairs investigations for public distribution	Annually	April	Sheriff, Affected Members of Executive Command Staff	26.2.5
Agency Component Inspections (5-170)	Commander, OPR	Inspection of facilities, equipment, vehicles, uniforms, personnel, files, security and operating procedures, records, publications, and any other facet of the component's operation which may impact its operations or readiness to fulfill its designed purpose	Every 4 Years (beginning 2019)	August	Sheriff, Affected Members of Executive Command Staff	53.2.1
Review of Victim/Witness Needs and Available Services (5-172)	Commander, CID	Review of victim/witness assistance needs and available services within the Agency's service area	Every 2 Years (beginning 2019)	April	Sheriff, Affected Members of Executive Command Staff	55.1.2
Selective Traffic Enforcement Report (5-183)	Commander, SOD	Review of selective traffic enforcement to determine effectiveness of activities and suggestions for upcoming efforts	Annually	March	Sheriff, Affected Members of Executive Command Staff	61.1.1
Crossing Guard Review (5-173)	Commander, SOD	Review of current and possible future locations for crossing guards to determine the need to continue, abandon, or create crossing guard locations	Annually	October	Sheriff, Affected Members of Executive Command Staff	61.3.4
Court Security Survey (5-178)	Commander, Special Services Division	Review of court security needs with court personnel to include facilities, equipment and security plans	Every 2 Years (beginning 2018)	March	Sheriff, Affected Members of Executive Command Staff	73.2.1
Central Records Computer System Security Audit (5-180)	Director, IT	Audit of security passwords and protocols for CAD/RMS as well as Document Imaging System to identify any security breaches	Annually	March	Sheriff, Affected Members of Executive Command Staff	82.1.6
Inspection of Property Control Procedures (5-182)	Commander, Property Management Section	Inspection conducted to determine the cleanliness of the property room, the integrity of the property is being maintained, property management system are being followed, property is being protected from damage or deterioration, and property is being disposed of property	Semi-Annually	January & July	Sheriff, Affected Members of Executive Command Staff	84.1.6 (a)
Joint Custodian Property Inventory Audit (5-182)	Commander, Property Management Section	A joint audit associated with evidence custodian transfers – Audit a sampling of the total amount of high risk (e.g., money, precious metals, jewelry, firearms, and drugs) property records under the agency's care must be reviewed with respect to documentation and accountability	During a change in Property Custodian	Prior to assuming custody of property	Sheriff, Affected Members of Executive Command Staff	84.1.6 (b)
Property Management Audit (5-182)	Commander, OPR	Audit to ensure the integrity of the property management system and the accountability of property.	Annually	December	Sheriff, Affected Members of Executive Command Staff	84.1.6 (c)
Unannounced Inspections of Property Management (5-182)	Commander, OPR	Unannounced inspection of the property and evidence areas, inspecting for cleanliness, orderliness and tracing a few pieces of property and evidence to assure they are in the proper place as stated in the property records	Annually	After completion of each inspection	Sheriff, Affected Members of Executive Command Staff	84.1.6 (d)
EST Operations Report (5-185)	Commander, SOD	Report on the status and use of the Emergency Services Team	Semi-Annually	January and July	Sheriff, Affected Members of Executive Command Staff	N/A
Standard Operating Procedure (SOP) Manuals (0-009)	Division Commanders	Review of SOP manuals containing policies and procedures specific to various sections/units of the Agency	Annually	Rotating Schedule	All Affected Personnel, Posted on Intranet	N/A





Administrative and Operational Manual

September 12, 2022

Serious Officer-Involved Incidents Report	Commander, OPR	Report documenting the number of officers disciplined each year and the type of discipline administered	Annually (Submit data annually to MPCTC)	April	Sheriff, Affected Members of Executive Command Staff	N/A
Personnel Early Warning System Review (3-680.4)	Commander, Administrative Services	A documented review and evaluation of the system in order to address the needs of the employees and Agency	Annually	March	Sheriff, Affected Members of Executive Command Staff	35.1.9 (e)
Special Evaluation Report Review	Commander, Administrative Services	Review and evaluate the system in order to address the needs of employees and Agency	Annually	March	Sheriff, Affected Members of Executive Command Staff	Related to 35.1.6
Fit for Duty Evaluation Report	Commander, Administrative Services	Review and evaluate the system to address the needs of the employees and Agency	Annually	March	Sheriff, Affected Members of Executive Command Staff	Related to 26.3.7
Community Policing Report	Commander, Special Operations	Report documenting the Community Policing Unit's collaborative community involvement process to include identifying community concerns and potential problems that have bearing on law enforcement activities within the community, recommended actions and progress statements	Quarterly (Compiled into an Annual Report for the State)	January, April, July, October	Sheriff, Affected Members of Executive Command Staff (Annually to the State)	45.2.1 (e)
Administrative Review of Temporary Detention Areas and Procedures (4-660)	Commanders in charge of facilities containing temporary detention areas	Administrative Review of temporary detention areas to identify and address concerns such as cleanliness, safety, adherence to Agency policies and procedures, and to determine if the use of the facility continues to adequately meet the needs of the Agency	Annually	October	Sheriff, Affected Members of Executive Command Staff	71.4.3
Speed Monitoring System Report	Commander, Special Operations	A Speed Monitoring System report which includes criteria related to citations, revenue, expenditures, etc. The full list of criteria can be found in Transportation Article 21- 809 (b) (6) (k) (2).	Annually (Submit data annually to MPCTC)	October	Sheriff, Affected Members of Executive Command Staff	N/A

5-200 AGENCY FORMS

The Charles County Sheriff's Office uses many different forms in the completion of its daily activities. These forms are both internally and externally developed. Regardless of the origin of a particular form, all forms will be controlled and utilized in accordance with Agency policy applicable to that form.

Forms developed outside the Agency may have associated instructions detailing their use. These instructions may be adopted, modified or added to, in order to meet the needs of the CCSO. In any case, a division / section will be identified as the subject matter expert, regarding the use of each form developed outside the Agency.

In contrast to forms developed outside the Agency, many forms are developed and used specifically in response to the needs of the Charles County Sheriff's Office. Each of these forms will have an Agency division / section assigned as the subject matter expert regarding its development and use.

For each form, there must be a method to ensure:

- the form is appropriate to the use made of it by the Agency;
- there is a ready supply of the current issue of each form or it is available on the Agency intranet;
- there is a process for removing an obsolete form;
- there is a process for creating a new form as the need arises.

5-200.1 FORMS CONTROL

**Administrative and Operational Manual****September 12, 2022**

Forms used by the CCSO shall be controlled. Forms used by the Agency are required to have an assigned form number; and an example of each form should be available on the Agency Intranet in the PDF and/or WordPerfect and/or Word format. Forms which are used only within a single component of the Agency will still require the assignment of an Agency form number. A master of each Agency form shall be maintained, and a record of its history accurately kept by the Forms Control Planner.

**5-200.2 FORMS RESPONSIBILITY**

The authority and responsibility for development and control of Agency forms is assigned to the Forms Control Planner under the supervision of the Deputy Director, Planning & Accreditation. This function will be accomplished in conjunction with the component or components of the Agency which will make use of the form. The responsibility for printing, ordering and stocking of Agency forms that for various reasons cannot be printed off the Agency Intranet is assigned to the Quartermaster. The commander / deputy director / manager of each component of the Agency where forms are used, or held available for use, is responsible to ensure that only current and approved forms are held or used. Commanders / deputy directors / managers will ensure that any form necessary for the completion of his personnel's duties is available for their use.

Individual employees will use only approved Agency forms, listed on the Agency Intranet, or others as may be required by law or another government entity which controls a process which the employee is subject to use. For example: Accident Reports, Traffic Citations, Probable Cause, Animal Bite Reports, etc., are developed and controlled by Maryland State Agencies.

If a form is used only within a single component of the Agency, it may be stocked only within that component or printed from the All Forms folder in the Forms section of the Agency Intranet. However, ordering or printing of the form will remain the responsibility of the Quartermaster. The commander / deputy director / manager of any component using forms will be responsible for notifying the Quartermaster when supplies are getting low in order that the Quartermaster may have time to reorder.

**5-200.4 FORMS DEVELOPMENT**

All Agency forms will be computer generated.

When the need for a new form arises, or the revision of an existing form is apparent, the following procedure will be followed:

- a mock-up of the new form or a corrected copy of an old form will be sent to the Planning & Accreditation Forms Control Planner.
- the completion of the process will require that any new form is assigned a CCSO Form number (#) and given a creation date, and any updated form is assigned a new revision date;
- upon completion of the revision or creation of an Agency form, an updated version of the form with an explanation of the change(s) and reason(s) and person(s) requesting changes will be emailed to the responsible commander / deputy director / manager who is described as the subject matter expert, for approval at the division level;
- upon receipt of the approval either by email or personal notification, the Forms Control Planner will update the forms history log and prepare the form to be placed on the Intranet;
- the Forms Control Planner, Planning & Accreditation, will place the approved version onto the Agency Intranet. It should be placed in the All Forms Folder and, if appropriate, in the folder of the division to which the form is assigned;



Administrative and Operational Manual

September 12, 2022

- 
- the Forms Control Planner, Planning & Accreditation, will also update the forms accountability log to reflect all updated information;
  - copies of all correspondence as well as drafts should be placed in the forms folder for future reference;
  - if a form is deemed by the division / section to be obsolete, an email or verbal notification from the Division / section commander / deputy director / manager should be sent to the Forms Control Planner stating the obsolete status and their approval to remove it from active status;
  - if a form is determined to be obsolete, it will be removed from the Agency Intranet and the form status updated on the accountability log to reflect its obsolete status and date.

### 5-200.5 INTRANET FORMS

A copy of each form will be placed on the Agency Intranet for all employees to view. All forms will appear in the All Forms Folder. Some forms will also appear in subfolders for easier access. To search for a form by name or form #, choose the All Forms Folder or the division folder and click on the edit button located at the top of the screen. Choose the *Find on this page* option and type in the form name or number. It will then be possible to scroll through the list of forms containing the information entered.



**Administrative and Operational Manual**

**September 12, 2022**

## **5-300 AGENCY CORRESPONDENCE**

### **5-300.2 STATIONERY FORMAT**

All Agency correspondence will be prepared on one of the following forms:

- **LETTERHEAD STATIONERY:** All correspondence sent outside the Agency and formal letters from the Sheriff, Assistant Sheriff(s), or division commanders to Agency employees. A business envelope will be used.
- **INTER-OFFICE MEMORANDUM:** Correspondence within the Agency. The reusable envelopes currently in the Agency supply will be used.

### **5-301 MAILING INSTRUCTIONS**

All outgoing correspondence which requires postage will be forwarded to Records, along with the Outgoing Mail Codes Form #756, properly addressed and sealed.

### **5-302 MECHANICS OF BUSINESS LETTERS**

**Date Line** - the date line should be aligned with the complimentary close, two to four spaces below the letterhead, or even more if the letter is very short.

**Inside Address** - place the inside address at the left margin of the letter, not less than 2 spaces, nor more than 12, below the date line. The exact position of the first line of the address depends on the length of the letter. The inside address should not extend beyond the middle of the page.

The inside address should correspond exactly with the official company, name and address.

Do not abbreviate names of cities, territories or possessions, but use the 2-letter ZIP code abbreviations for states.

**The Salutation** - type the salutation two spaces below the inside address. If an attention line is used, type the salutation two spaces below the attention line.

Capitalize the first word, the title and the name. Do not capitalize "Dear" unless it is used as the first word of the salutation. Use a colon following the salutation.

The salutation in a letter that is not addressed to any particular person or firm, such as a general letter of recommendation is: To Whom It May Concern.

If the letter is addressed to a company to the attention of an individual, the salutation is to the company, not to the individual.

**The body** - indent five spaces for each paragraph. Single space unless the letter is very short; double space between paragraphs.

**The Complimentary Close** - type the complimentary close two spaces below the last line of the letter. Begin it slightly to the right of the center of the page, aligned with the date. It should never extend beyond the right margin of the letter. In letters of more than one page, four lines should be on the page with the close. Follow the complimentary close with a comma.



Administrative and Operational Manual

September 12, 2022

**5-303 ADDRESS OF PERSONS HOLDING HONORARY OR OFFICIAL POSITIONS**

Use of formal or informal salutations and closure depends upon how well the writer knows the addressee and whether the subject matter of the letter is personal or official business.

When a person is acting as an official, the word “acting” precedes the title in the address, but not in the salutation or spoken address.

A person who has held a position entitling him to be addressed as “The Honorable” is addressed as “The Honorable” after retirement. The title itself, such as Senator or Governor, is not used in the address or salutation. Even a former president is called Mr. An exception to this practice is the title of Judge. A person who has once been a judge customarily retains his title even when addressed formally. Retired officers of the Armed Forces retain their titles, but their retirement is indicated thus, Lieutenant General John D. Blank, U.S.A., Retired.

In many cases the name in the address is followed by the abbreviation of a scholastic degree. If you do not know whether the addressee has the degree, you should not use the initials. Nor should a person be addressed by a scholastic title unless he actually possesses the degree that the title indicates.

If a business title is short, place it on the first line. If it is long, place it on the second line.

Honorable (Current Senator’s Name)  
United States Senate  
Washington, D.C. 20510

Dear Senator \_\_\_\_\_:

Honorable (Current Representative’s Name)  
House of Representatives  
Washington, D.C. 20515

Dear Mr./Mrs. \_\_\_\_\_:

**5-304 TRANSMITTAL OF INTRA-AGENCY CORRESPONDENCE**

As addressed elsewhere in this Manual, all correspondence directed to a member of the Agency Command Staff will adhere to the employee’s chain of command unless otherwise specified. Examples of that which may be transmitted outside the chain of command include but are not limited to:

- correspondence of a personal nature;
- unresolved complaints of discrimination or harassment; and/or
- any matter which may have an operational need to remain highly confidential.

Correspondence will be in memorandum form addressed to the final recipient “through” each member of the sender’s chain of command. Each member of the chain of command will review, comment on and initial the correspondence. In this way, each subsequent recipient and the addressee will be assured the chain of command has been followed and of each member’s thoughts on the contents of the correspondence. The Inter-Office Memorandum Form #144 will be used as a cover sheet for this purpose. The body of the correspondence will be on any attached page(s) with the following heading format:

- Memorandum - Continuation Page; followed by
- To;; followed by
- From;; followed by



Administrative and Operational Manual

September 12, 2022

- 
- Date:; followed by
  - Subject:

## 5-305 RECEIPT AND DISSEMINATION OF INFORMATION

Each commander / manager will designate a member as responsible for distribution of correspondence to the appropriate employee within that particular section.

As mail in general is often delivered to a central location within each Agency facility, when addressing intra-Agency correspondence employees will include a location and/or section designation with the recipient's name. Employees responsible for forwarding mail / correspondence received in bulk will ensure it is forwarded to the proper location in a timely manner.

All mail (intra- or inter-Agency mail, reports, U.S. Postal mail, etc.) requiring distribution to Agency sections / facilities or outside entities will be delivered to Headquarters for sorting, processing and pick up by designated employees. No other Agency station or facility will be used as a collection or distribution site unless that location is the final destination of the correspondence.



Administrative and Operational Manual

September 12, 2022

**EXAMPLES**

5-304

INTER - OFFICE MEMORANDUM

Charles County Sheriff's Office

Date: \_\_\_\_\_

To: (NAME AND TITLE) \_\_\_\_\_

From: (NAME AND TITLE) \_\_\_\_\_

Re: \_\_\_\_\_  
(3 Spaces)

\_\_\_\_\_

\_\_\_\_\_

\_\_\_\_\_

\_\_\_\_\_

\_\_\_\_\_

\_\_\_\_\_

(2 to 4 Spaces)  
Forwarded:

\_\_\_\_\_  
(Title of Immediate Supervisor)

\_\_\_\_\_  
(Title of Next Immediate Supervisor)



Administrative and Operational Manual

September 12, 2022

5-305

INTER - OFFICE MEMORANDUM:

Charles County SHERIFF'S OFFICE

(CORRESPONDENCE FORWARDED THROUGH CHAIN OF COMMAND)

Date: \_\_\_\_\_

To: (NAME AND TITLE) \_\_\_\_\_

From: (NAME AND TITLE) \_\_\_\_\_

Re: \_\_\_\_\_  
(3 Spaces)

\_\_\_\_\_  
\_\_\_\_\_  
\_\_\_\_\_  
\_\_\_\_\_  
\_\_\_\_\_  
\_\_\_\_\_

(2 to 4 Spaces)  
Forwarded:

\_\_\_\_\_  
(Title of Immediate Supervisor)

\_\_\_\_\_  
(Title of Next Immediate Supervisor)





Administrative and Operational Manual

September 12, 2022

## CHAPTER 6 – RISK MANAGEMENT, SAFETY, AND FITNESS

### 6-100 PURPOSE

The purpose of establishing a defined Risk Management and Safety Policy is to prevent and/or substantially decrease all types of occupational accidents and illnesses. It is the goal of the Charles County Sheriff's Office and its employees to increase productivity by securing a work environment free of safety hazards.

The occupational safe work practices outlined in this policy are applicable to all employees of the Charles County Sheriff's Office. Every job is designed to serve the public, and, in the performance of this service, the safety of all employees and the public is paramount. Employees are expected to familiarize themselves with, and abide by, job procedures and safety guidelines specific to their respective departments.

It is the policy of the Charles County Sheriff's Office to administer its programs so that employees work under safe and healthy conditions, seek out and correct unsafe conditions, eliminate unsafe acts, and make accident prevention an important responsibility.

Therefore, risk management and accident prevention is not separate from, nor is it in addition to, normal job procedures. It is the combination of safe work procedures, safe conditions and equipment, and a total commitment to safety that is an integral part of the Sheriff's Office.

All employees shall receive documented orientation and periodic training detailing responsibilities and procedures for developing and maintaining a safe working environment, which are detailed in the Risk Management and Safety Policy.

This policy shall be reviewed and updated annually to address changes in current safety practices and procedures.

### 6-101 EMPLOYEE RESPONSIBILITIES

It is the responsibility of all employees of the Charles County Sheriff's Office to create and maintain a safe working environment free from unnecessary hazards or unsafe working conditions. It is imperative that the administration of this Agency provide for Sheriff's Office employees the tools and resources necessary to accomplish those tasks. When in the work environment, all employees will maintain a safe work ethic by considering the following:

- safety for yourself;
- safety for your co-workers;
- safety for the public;
- protection of Sheriff's Office and County property; and
- protection of private property.

It is the duty of each employee to know and follow regulations which pertain to any work he might perform. This includes the application of regulations outlined in this policy supplemented by regulations which pertain to individual job assignments and the use of common sense in all situations.

If an employee feels for any reason that he is unable to do assigned work, the supervisor in charge is to be advised and informed of the reasons.

When an employee considers that the work being done is in violation of the provisions of this policy, or that sufficient safeguards are not being used, or that the work is not being performed in a safe manner, the employee should immediately bring the matter to the attention of a supervisor.

It shall be understood by employees that we operate under those rules and regulations of the Maryland Occupational Safety and Health Administration (MOSHA) and the Occupational Safety and Health Act (OSHA).



## Administrative and Operational Manual

September 12, 2022

Employees violating safety rules, procedures, or standards, or acting in a manner which endangers their own or another's personal safety, may be subject to disciplinary action.

## 6-102 SUPERVISORS' RESPONSIBILITIES

All levels of supervision shall have responsibility for safety.

Supervisors have the authority and responsibility for maintaining safe working conditions within their jurisdictions. Although personnel exposure to hazards varies widely from division to division, it is expected that an unrelenting effort will be directed toward controlling injuries, accidents, liabilities and waste of materials. Therefore, supervisors shall:

- Ensure that the policies and procedures set forth herein are complied with by all personnel under their direction;
- Provide the leadership and positive direction essential in maintaining loss prevention policies as a consideration in all operations;
- Ensure personnel are provided with the proper safety equipment needed to perform their tasks in a safe manner and reinforce the need for each employee to use the personal protective equipment given to them;
- Devote a portion of staff meetings as needed, to discuss safety issues;
- Call upon the Standards, Inspections, and Safety Officer for any assistance needed in promoting effective safety control;
- Investigate incidents immediately for accurate reporting and preventive action;
- Ensure each division commander is aware of injuries, accidents and liabilities incurred by his employees. An excessive number is an indication that some policies and practices need corrective or disciplinary action;
- Ensure that on-the-job injuries and accident reporting procedures are followed;
- Be aware of the status of employees off work due to on-the-job injuries or accidents, and make modified duty assignments available where applicable;
- Receive training as needed to enable them to discharge their responsibilities and provide leadership, direction, and support for the Risk Management and Safety Program by means of the following:
  - Setting a good example;
  - Being familiar with, evaluating, and ensuring compliance with the safety rules;
  - Being aware of the principal causes of accidents;
  - Ensuring that speedy corrective action is taken on all known safety hazards;
  - Supporting safety enforcement activities of subordinates;
  - Ensuring that all employees are permitted to report safety hazards without fear of reprisal;
  - Recommending revisions in this policy to address changing Sheriff's Office needs and new developments in the field of Occupational Safety and Health.

## 6-103 SAFETY AND INSPECTIONS OFFICER

The Safety Officer (Standards, Inspections, and Safety Officer) shall watch for and report unsafe behavior and practices. The Safety Officer is responsible to make official reports of all unsafe activities. The Safety Officer is



Administrative and Operational Manual

September 12, 2022

also required to draw immediate attention to, and make immediate notifications of, any unsafe activity which poses an imminent danger.

Instant notifications made by the Safety Officer can be to the individuals involved in the unsafe activity, a controlling supervisor, or any management or administrative official who may assist in remedying the unsafe condition or activity. Such notifications are in addition to the requirement for the Safety Officer to make written reports.

The Safety Officer is not charged to personally regulate safe behavior of employees in the manner of a supervisor. The Safety Officer acts in an administrative capacity. Supervisory and management personnel are charged to make operational decisions in light of the Safety Officer's recommendations, and report in writing through the chain of command to the Commander, OPR, any need to ignore or act contrary to these recommendations.

The Safety Officer is a part of the Office of Professional Responsibility and reports directly to the division commander. All required reports under this policy section are made to the Commander, OPR. The commander will report any significant issues to the Assistant Sheriff of Administration.

Unsafe activities fall into two categories. One is individual behavior contrary to instructions or to normal safe conduct. This sort of behavior shall be corrected through the employee's chain of command. In cases where supervisory personnel are not contacted directly regarding an employee's unsafe activities, supervisors will be made aware of such activities through the written reports of the Safety Officer forwarded through the chain of command.

The second type of unsafe behavior stems from unsafe methods and procedures permitted by someone in authority. The Safety Officer shall report to the Commander, OPR, in writing, such unsafe practices and recommend corrections. The Safety Officer shall not be concerned about disciplinary action for unsafe behavior, only that it is corrected. His duties will include and are not limited to:

- Acting as the central liaison official for all accident prevention and safety programs throughout the Sheriff's Office;
- Assisting all divisions in the establishment of an effective and on-going safety awareness and education program;
- Providing coordination throughout the Agency on all matters relating to safety and injury prevention;
- Ensuring that on-the-job injury and vehicle crash reporting procedures are kept current;
- Assisting in the investigation of accidents or reported hazards;
- Performing field inspections and investigations in cooperation with appropriate department personnel;
- Maintaining objectivity and independence in carrying out the Agency's safety responsibilities;
- Establishing procedures for handling suggestions and recommendations on safety issues;
- Providing and updating information to management, supervisors and first-line employees on safe working methods and practices;
- Recommending changes or additions to improve protective clothing and equipment for the elimination of hazards;
- Recommending or revising standard operating procedures to comply with current safety standards;
- Promoting safety and first aid training for employees;



Administrative and Operational Manual

September 12, 2022

- Participating in safety promotion programs;

The Safety Officer will conduct safety audits in accordance to specifications established by OSHA / MOSHA. Notification will be made to division commanders, documenting findings. The Safety Officer shall carry with him a copy of the previous inspection report while conducting safety audits. The Safety Officer shall document noted deficiencies and include them in his report. Upon completion of safety audits, the Safety Officer shall review with respective division commander deficiencies noted prior to completion of a written report. A copy of the report shall be forwarded to the division commander where the inspection took place. The report must be thorough and understandable. Locations shall be accurately named or numbered, machines and operations identified, and unsafe conditions or actions described in detail, e.g., a notation of "bad housekeeping" is insufficient; the report shall be specific.

## 6-104 SAFETY INSPECTIONS

The Standards, Inspections and Safety Officer will conduct annual safety inspections of each component of the Agency. Those inspections may be done randomly, or as a follow-up inspection in an area where safety issues have been discovered. He will develop procedures for the conduct of staff inspections, prepare written reports of the results of the inspection, with recommendations for correction of any noted deficiencies, note any positive aspects of the operation of the component inspected, and develop a time-table for follow-up inspection of any deficiencies which could not be corrected during the course of the initial inspection. He will detect and prevent fraud, waste and abuse of Agency resources.

### 6-104.1 SAFETY SUGGESTIONS

Suggestions by employees are always welcome and helpful in preventing accidents. Suggestions may be submitted to a supervisor or to the Safety Officer directly.

Safety suggestions shall explain the potential problem or hazard and give any possible solutions to correcting the matter.

## 6-200 SAFE WORK PRACTICES

Most accidents and injuries can be avoided by the application of caution and common sense under all working situations. Safety should be a consideration in every situation.

Employees must take every precaution to prevent accidents involving the general public, fellow employees and themselves. Employees shall follow instructions and obey and apply safety rules and practices at all times:

- Whenever personal protective equipment (vehicle seat belts, hard hats, respirators, etc.) are provided for protection, their usage is required;
- Know the job and be fully acquainted with the tools and equipment used on each job. Be familiar with safety requirements. Only authorized and properly trained personnel shall operate equipment;
- Smoking and/or cell phone use are prohibited when refueling equipment or handling gasoline or other volatile materials;
- All chemicals shall be properly labeled. Promptly store flammable materials in approved containers to prevent fires;



Administrative and Operational Manual

September 12, 2022

- Keep work areas clean and orderly at all times, free of trash and unnecessary equipment. Straighten up personal work area daily and dispose of hazardous materials properly;
- Use passageways and aisles as directed. Office furniture and equipment shall be arranged to allow easy traffic flow and to minimize tripping hazards;
- Never use chairs, desks, tables, boxes, file cabinets, etc., for ladders;
- Exercise caution when working in hot temperatures;
- Do not attempt repairs on equipment, unless such repair is part of your duties;
- Use of extension cords or other electrical service extenders shall be used only as directed by a manufacturer. Keep cords clean and free from exposure to heat which can damage insulation;
- Treat all electrical wires as live wires;
- Do not drag cords over sharp edges or run cables across aisles where they are subject to damage;
- Electrical shock is a sign that something is wrong. Any equipment which shocks when used shall immediately be disconnected, reported to a supervisor, and replaced or repaired as necessary;
- Never leave an unsafe condition unguarded or unmarked--even temporarily;
- First aid kits shall be available;
- No attempt shall be made to lift an object beyond personal physical ability;
- Do not wear loose jewelry or loose clothing (neckties, loose headbands, and shirt tails) when working around or operating rotating machinery or tools.

## 6-201 EMPLOYEE FITNESS PROGRAM

A physical fitness testing program has been created for sworn and correctional officers of all ranks. The test will be administered by the Fitness Coordinator on an annual basis. While all sworn and correctional officers are required to participate in the testing, civilian employees may volunteer to participate and are encouraged to do so. All employees should be examined, at their own expense, by a licensed physician prior to the actual fitness test, which may be conducted at any location convenient to the employees and the Fitness Coordinator.

The hope is that all Sheriff's Office employees will develop healthy habits that will not only serve them well during their service here, but will carry on into retirement and endeavors outside the Sheriff's Office. Satisfactory general health and physical fitness may also positively affect mental health and aid in reducing stress and anxiety associated with our profession.

Studies have shown that an officer who appears fit and confident is less likely to be challenged by a potentially violent offender. Officers should strive to present a professional appearance in and out of uniform, and that includes maintaining a healthy fitness level. This profession places officers in harm's way and there is a realistic need to be prepared to face those challenges. Officers are encouraged to have pride in their overall appearance and to live up to the expectations of those we are committed to serve as well as those we serve beside.



## Administrative and Operational Manual

September 12, 2022

### 6-201.1 FITNESS COORDINATOR

The Fitness Coordinator will be a certified Police Fitness Specialist through the Cooper Institute or other accredited institution. The Fitness Coordinator's position incorporates a variety of duties related to the development and implementation of the program.

The Fitness Coordinator will maintain constant communication with the Agency through the use of an Intranet page and a newsletter. When time permits, the Fitness Coordinator will conduct educational classes for Agency members interested in improving their health.

### 6-201.3 FITNESS TESTING PROGRAM

The Sheriff's Office recommends that all employees participating in the physical fitness assessment strive to achieve a score at least in the "Fair" range based on the standards created by the Cooper Institute, which are incorporated into this policy. Scoring in the higher categories is encouraged. Each component of the test has been determined to have a direct correlation to the physical demands of law enforcement officers, and a strong emphasis is placed on cardiorespiratory health. Non-sworn employees will also benefit by maintaining a higher standard of fitness. Studies by the Cooper Institute have shown that having a moderate to high level of cardiorespiratory fitness significantly decreases the risk of developing coronary artery disease, Type 2 diabetes, hypertension, and certain cancers. The Fitness Coordinator has received training from the Cooper Institute and can provide advice regarding how to achieve an acceptable level of cardiorespiratory fitness.

Officers on modified duty will not participate in the testing without written authorization from their physician, provided to the Fitness Coordinator.

Should an officer be unable to score at least "Fair" during the physical fitness assessment, there will be no negative action taken against the officer. The Fitness Coordinator can design a program for the officer in an effort to create a healthier lifestyle and to improve the officer's physical fitness level. The Fitness Coordinator is available to assist Agency personnel to prepare for the physical fitness assessment and is also available to assist employees interested in adopting a healthier lifestyle.

The physical fitness assessment is comprised of the following:

- Vertical jump test – measures explosive power of the lower body;
- One-minute push-up test – measures upper body dynamic strength;
- One-minute sit-up test – measures muscular endurance of the abdominals;
- 1.5-mile run – measures cardiovascular capacity.

There will be some employees who receive medical guidance to defer portions of the testing due to significant health concerns. Participation in the physical assessment as it is written is strongly encouraged; however, the Fitness Coordinator has the ability to facilitate modifications to the testing when absolutely necessary.

Any information obtained by the Fitness Coordinator that could be considered medical information will be maintained by the employee, and will not be shared with the Sheriff's Office.

Officers can find a detailed explanation of the fitness test on the Agency Intranet, under Division Links / Training / Fitness Testing.

### 6-201.4 FITNESS INCENTIVES

The goal of the Agency is to have all participants eventually score at least "Fair" on all components of the assessment; however, there are financial incentives in place to encourage higher scoring. To be eligible for incentives, participants must score "Good," or better, in at least two events. The incentives are predicated on the



Administrative and Operational Manual

September 12, 2022

availability of funds, and are to be paid the first pay period in April, upon the receipt in the Deputy Director, Budgeting Section of a certification of completion signed by the Fitness Coordinator. The Training Division is responsible for compiling and submitting the list of eligible employees for the incentive pay by end of calendar year.

FAIR consists of:

- 20-24 1-minute push-ups
- 25-29 1-minute sit-ups
- 16:01-18:00 minute 1.5 mile run
- 9-11 inch vertical jump

A score of Fair passes the test, but there is no financial incentive.

GOOD consists of:

- 25-29 1-minute push-ups
- 30-35 1-minute sit-ups
- 15:00-16:00 minute 1.5 mile run
- 12-17 inch vertical jump

A score of Good results in \$40 / year per event, and a max of \$160 if participant scores Good in all events.

EXCELLENT consists of:

- 30-39 1-minute push-ups
- 36-42 1-minute sit-ups
- 14:00-14:59 minute 1.5 mile run
- 18-21 inch vertical jump

A score of Excellent results in \$60 / year per event, with a max of \$240 if participant scores Excellent in all events.

SUPERIOR consists of:

- 40 or more 1-minute push-ups
- 43 or more 1-minute sit-ups
- Under 14:00 minute 1.5 mile run
- 22 inches and over vertical jump

A score of Superior results in \$80 / year per event, with a max of \$320 if participant scores Superior in all events.

If a participant scores Fair in one event (\$0), Good in another (\$40), Excellent in another (\$60), and Superior in another (\$80), the total incentive received would be \$180 for the year.

In addition to the physical fitness incentives, officers can receive compensation for two non-physical activities. Officers can receive \$50 compensation with written proof of having either a physical or a dental exam, or \$100 compensation for both exams. The officer must provide Form #105 completed and signed by their doctors by the end of the calendar year (December 31). This completed form must be turned into the Training Division no later than January 15<sup>th</sup> of the following year. The officer will be compensated for the exams by the first pay period in April.



## Administrative and Operational Manual

September 12, 2022

**6-201.5 PERSONAL TRAINING PROGRAM**

The purpose of the personal training program is to educate participants in the principles of progressive resistance training, cardiovascular health, and proper exercise technique. This is a voluntary training program administered by the Fitness Coordinator for employees interested in improving their overall health and fitness. Participants will work individually or in small groups with the Fitness Coordinator.

**6-201.6 NEWLY HIRED POLICE AND CORRECTIONAL OFFICERS**

Newly hired recruits will be expected to improve their physical fitness levels as they proceed through the Police or Corrections Academy. Cadets are strongly encouraged to meet with the Fitness Coordinator in order to ensure they are properly prepared upon acceptance to the Police or Corrections Academy.

**6-202 PROCEDURES IN CASE OF ACCIDENT OR INJURY**

All accidents and/or injuries involving an employee or volunteer shall be reported to a supervisor as soon as possible. Supervisors and employees should see that an injured employee receives prompt medical attention.

When an employee is injured on the job, a Report of Injury or Illness, Form #227, shall be completed and faxed to Human Resources within twenty-four (24) hours of the injury (per AOM 3-610.1). The employee - or in the case the injuries prevent such preparation, the supervisor - shall prepare Form #227. Supervisors shall investigate all injuries. There are areas for the supervisor to record information required for the investigation, specifically witness and supervisor blocks, etc. The investigation shall be completed on Form #227 before the end of the shift during which the injury occurred. Should additional space be required, a continuation / supplement can be submitted with Form #227. A separate report is not needed. The Form #227, along with any attachments, will be faxed to Human Resources and originals sent through the chain of command to Human Resources.

Employees should be aware of the following procedures when an accident or injury occurs:

- Know the location of first aid kits;
- Provide first aid until a more qualified person is available to do so;
- Contact 911 for emergency assistance (if needed) as soon as possible;
- Do not move the victim more than is absolutely necessary;
- Keep onlookers away from the victim;
- Report all injuries, no matter how slight, to a supervisor;
- If possible, an employee at the accident scene shall accompany the injured to the hospital;
- A supervisor will go to the hospital to coordinate the investigation and Sheriff's Office responsibilities;
- If the accident is serious enough to warrant immediate investigation at the scene, the Safety Officer shall be notified and included in the investigation; and
- If the accident is serious, the supervisor shall immediately notify the division commander of the involved employee.

**6-202.1 VOLUNTEER INJURIES**

Anyone who is serving the Charles County Sheriff's Office as a volunteer, and who is injured while on duty or becomes physically ill or otherwise incapacitated, shall report the injury or illness to a supervisor as soon as possible. The supervisor will ensure a Report of Injury or Illness, Form #227, is completed and that the volunteer receives prompt medical attention. The completed form shall be faxed to Human Resources. Originals of the Report of Injury or Illness form and any related police incident reports shall be forwarded to the appropriate Commander / Director to whom the volunteer was assigned, who will in turn submit them to the Administrative Services Division.





## Administrative and Operational Manual

September 12, 2022

Modified duty tasks for eligible volunteers will be determined on a case-by-case basis; consideration will be given to the specific medical / personal needs of the volunteer and the Agency.

## 6-202.2 INJURY INVESTIGATIONS

The supervisor will investigate all injuries incurred by an employee as a result of an employee's performance of their duties and provide details of the investigation on the Report of Injury or Illness. The report will contain at least the following information:

- the circumstances and facts related to the injury event;
- the investigator's opinion of the cause of the injury;
- the use or lack of use of any safety devices which could have or should have prevented or lessened the injury;
- statements of the injured employee and any witnesses to the injury; and
- the investigator's recommendations for removal of any discovered hazards causing or contributing to the cause of the injury.

**NOTE:** Injury investigations are considered internal personnel investigations and are confidential and protected from general disclosure, the same as any Internal Affairs or personnel matter. They will not have an I.R. number assigned. Injury benefits and restrictions are outlined elsewhere in this Manual.

## 6-202.3 OFFICERS INVOLVED IN CRITICAL INCIDENTS

Per the MOU, whenever an officer is seriously injured or killed as a result of an accident or assault, or is involved in an incident where another person is seriously injured or killed:

- As soon as practical, where the officer's radio and/or duty weapon is retained by the Agency, the Agency will provide the officer with a replacement radio and/or weapon, unless his police powers are suspended;
- As soon as practical, the Agency will notify the designated FOP representative about the incident; and
- The Agency shall release only the officer's last name, rank, tenure, and duty assignment to the public within the first 48 hours of the critical incident.

## 6-202.4 NOTIFICATION OF INJURY

The Sheriff, Assistant Sheriffs, and appropriate division commander will be notified whenever an employee is seriously injured on the job. Whenever possible, the district / shift commander shall respond to the scene.

## 6-203 USE OF INTOXICANTS AND DRUGS

The use of intoxicants and drugs by employees of this Agency can result in an immediate reduction of effectiveness and public support. Therefore, employees are held to comply with the following requirements:

- Employees are prohibited from consuming intoxicants while on duty and never in uniform, either on- or off-duty (Exception: As is necessary to execute an official assignment and only with prior approval of the employee's division commander / director).
- Employees are prohibited from reporting for work while impaired by or under the influence of any intoxicant (the odor of intoxicants upon the breath of the employee or about their person will be presumptive evidence of violation of this section).



## Administrative and Operational Manual

September 12, 2022

- Employees will not possess, bring into, or keep any intoxicant on Agency premises and/or Agency vehicles, except as necessary to execute an official assignment.
- Employees are prohibited from using any drugs (prescription or non-prescription) which will negatively impact their abilities to perform the essential functions of their positions. It is incumbent upon each employee to notify his supervisor immediately upon reporting for work if he has consumed or must continue to consume such a drug for medical purposes.

### 6-203.1 EMPLOYEE DRUG TESTING

The Charles County Sheriff's Office is obligated to ensure that employees do not use illegal drugs nor abuse prescribed medication. This obligation is accomplished through:

- employee participation in the Random Drug Testing Program;
- employee submission to testing for drug abuse as part of a program instituted as a result of prior disciplinary proceedings against the employee related to the use of drugs or alcohol;
- pre-employment testing for drug abuse by prospective employees; and
- testing where a reasonable suspicion exists that an employee may be abusing a controlled substance or prescribed medication.
- When reasonable suspicion exists that an employee is abusing controlled substances or prescribed medications, the employee's supervisor may require him to submit to testing. Testing shall be coordinated through the Office of Professional Responsibility.

Failure by an employee to comply with any component of the random drug testing program, as directed, shall be considered insubordination. Violations may result in administrative and/or disciplinary action, with a maximum penalty of dismissal.

### 6-203.2 DEFINITIONS

**Drug Testing Coordinator** - an Office of Professional Responsibility / Internal Affairs officer responsible for coordinating activities in the drug testing program and developing control methods to ensure program integrity.

**Medical Review Officer** - a licensed physician with knowledge of substance abuse disorders and appropriate medical training to interpret and evaluate positive laboratory test results together with an employee's medical history and any other relevant biomedical information.

### 6-203.3 RANDOM DRUG TESTING

The random drug testing program is a proactive approach to a serious problem facing our community. It is not based on:

- an identified drug problem within the Agency; or,
- targeting employee groups or specific employees.

The following is a sampling of drugs that may or may not be included in the urine test. This list is not all-inclusive, and specific drugs may be added to or deleted from the list at any time:



## Administrative and Operational Manual

September 12, 2022

- Amphetamines
- Barbiturates
- Benzodiazepines
- Cocaine
- Ecstasy
- Marijuana
- Methadone
- Methamphetamine
- Opiates
- Oxycodone
- Phencyclidine
- Propoxyphene

#### 6-203.4 ADMINISTRATION

The Commander, Office of Professional Responsibility, administers the random drug testing program through the Drug Testing Coordinator.

All information is considered confidential, and during the notification process, shall be released only to the employee's supervisor, commander or those with a legitimate need to know. No employee shall discuss the identity of any employee selected to be tested, except to make notifications to the employee at the time of test.

Records relating to employee drug testing are confidential, and shall be secured and maintained by the Drug Testing Coordinator. Any employee, without a legitimate need to know, who attempts to obtain confidential information concerning the identity of selected employees or tests results; or, who attempts to compromise or corrupt any component of the random drug testing program, shall be subject to disciplinary action up to and including dismissal.

#### 6-203.5 PERSONNEL SUBJECT TO TESTING

Employees subject to random drug testing are those who perform duties that, directly or indirectly, affect public safety or have unsupervised and/or direct access to sensitive information or drugs. This shall include all employees who, in performance of their duties, are required / authorized to operate Agency vehicles. These positions require the highest degree of trust and confidence and have a potential for abuse.

Employees to be tested shall be selected by automated random sampling. The Drug Testing Coordinator maintains lists of employees selected for testing. The names of selected employees shall not be announced in advance.

In a random selection process, some employees may be selected more than once a year, while others may not. The selection process is not affected by or related to other established mandatory drug testing; i.e., position testing, pre-employment, disciplinary action, or testing based on reasonable suspicion.

#### 6-203.6 NOTIFICATIONS

The drug testing coordinator notifies the selected employee's supervisor. The supervisor shall order the employee to report to the laboratory within two hours following notification. Supervisors shall complete Section I of the Random Drug Testing Notification Form #419 which the employee takes to the test site. Supervisors shall take employees to the laboratory if they are not assigned an Agency vehicle or their vehicle is unavailable for service.

In rare cases, employees may be unable to report to the test site within two hours of the notification. In such cases, supervisors shall immediately contact the Drug Testing Coordinator to explain the delay and advise the employee's anticipated time of arrival at the test site.

**Administrative and Operational Manual****September 12, 2022**

Supervisors shall follow up this notification with a written explanation, in memorandum form, to the Drug Testing Coordinator before the end of the shift.

**6-203.7 TEST DEFERRALS**

An employee shall only be deferred from drug screening when:

- on authorized leave at the time of notification;
- on official travel status out of the area;
- under suspension; or
- on administrative leave.

In deferral cases, the employee's supervisor shall notify the Drug Testing Coordinator of the employee's deferral status within two hours of receiving the selection notification. The employee's commanding officer then completes and approves Section III of the Random Drug Testing Notification Form. The completed form is sent to the Drug Testing Coordinator before the end of the shift in which the deferral occurs.

**6-203.8 TESTING PROCESS**

Notified employees shall respond to the contract laboratory with the Random Drug Testing Notification Form, and follow laboratory procedures as outlined in the donor checklist:

- present photo identification;
- the collector may be asked for his / her identification;
- remove all unnecessary outer garments such as coats, jackets, hats or caps; wallets may be kept, purses must be secured in the lock box;
- when instructed by the collector, wash and thoroughly dry hands;
- select an unopened specimen bottle;
- there will be the opportunity to provide a specimen in privacy;
- remain at the test site until a sample is obtained and provide a sufficient quantity of urine to conduct the test; and
- watch the preparation and sealing of the specimen and initial the identification label to ensure the integrity of the collection process;

Any employee unable to supply a urine specimen, due to medical reasons, shall be interviewed by a contract physician within twelve (12) hours. The contract physician may issue a deferral applicable only to the appointment for that date. If the physician does not issue a deferral, the selected employee shall immediately report to the test site and provide a urine sample.

**6-203.9 POSITIVE TEST RESULT**

If the laboratory determines that an employee's urine has tested positive for one of the drugs previously listed, the laboratory shall inform the medical review officer. The medical review officer shall verify the test result against the employee's medical history.

**Administrative and Operational Manual****September 12, 2022**

If the medical review officer determines that the employee used a controlled dangerous substance or abused a prescribed medication, he shall notify the drug testing coordinator who shall immediately notify the employee's commanding officer to facilitate an appointment between the employee and the medical review officer.

The commanding officer shall then designate a command officer to locate and order the employee to attend the appointment. The command officer shall accompany the employee to the appointment. Failure of an employee to attend a consultation session with the medical review officer, as ordered, is insubordination and will result in disciplinary action.

If the medical review officer cannot legitimize the use of the drug after the consultation, the employee's commanding officer shall contact the Internal Affairs Section. Internal Affairs shall conduct the follow-up investigation and coordinate any subsequent disciplinary action against the employee.

The drug testing coordinator shall notify the employee, via letter, of the positive test result and his right to have the samples examined at a laboratory of his choice and expense. The letter shall include a list of certified laboratories. Employees desiring independent tests shall respond in writing, within five working days of receipt of the notice, to the drug testing coordinator. The Internal Affairs investigator assigned the case will accompany the employee throughout this process to ensure the integrity of the independent test.

**6-203.10 NEGATIVE TEST RESULT**

An employee may presume test results were negative for the listed substances unless otherwise notified.

**6-204 INGESTION OR EXPOSURE TO CDS****6-204.1 USE OF CDS DURING COVERT INVESTIGATIONS**

The use of CDS during covert investigations is prohibited. However, conditions may arise where it is necessary for an investigator to ingest CDS to assure personal safety. If this occurs, the investigator shall notify his supervisor as soon as possible, no later than the end of the shift. The supervisor shall immediately notify the Commander, Office of Professional Responsibility through their chain of command, and an Internal Affairs investigator shall, for the benefit of the employee, arrange for a urinalysis test.

The supervisor shall document the incident on a confidential memorandum to his commanding officer, who shall determine whether or not the ingestion was justified. The Commander shall submit a copy of the memorandum to the Commander, Office of Professional Responsibility. Results of urinalysis, if known, shall not be recorded on any police report generated as a result of the incident during which the ingestion occurred.

**6-204.2 ACCIDENTAL EXPOSURE TO CDS**

Any employee, on or off-duty, subjected to inhalation or absorption of CDS shall notify a supervisor, as soon as possible after the occurrence. The supervisor shall document the incident before the end of the shift on a Report of Injury or Illness Form #227 and shall follow the procedure outlined in AOM 3-610.1 On-Duty Injury or Illness. The report shall indicate the substance to which the officer was exposed, and a brief account of the exposure. The supervisor shall forward a copy of the report, with appropriate recommendations, to the involved officer's commander.

After the commanding officer considers the totality of the circumstances and consults with the medical review officer, a representative of the contract laboratory or other qualified health care provider, he may order the affected employee to submit to urinalysis for the employee's benefit.



## Administrative and Operational Manual

September 12, 2022

## 6-300 BUILDING EMERGENCY EVACUATION

The purpose of this section is to facilitate the prompt and safe evacuation of the Charles County Sheriff's Office buildings in the event of a fire, bomb threat or other emergency situation.

Commanders will establish policy for emergency evacuation of the facilities under their command. All personnel assigned to work at any CCSO facility shall be familiar with this plan and learn the nearest exits and escape routes from their work areas prior to any emergency occurring.

### 6-300.1 EVACUATION PROCEDURES

It is the policy of the Charles County Sheriff's Office to evacuate any facility where a fire has erupted and is beyond the incipient stage. In the event of a fire, bomb threat or other emergency requiring the evacuation of a building, the following procedures are to be observed by all personnel:

#### Alarm Activation:

- any person who discovers a fire or becomes aware of an emergency situation requiring the evacuation of a facility will immediately pull the closest fire alarm box;
- normally, activation of the fire alarm system causes all exit doors to automatically unlock; however, in case of a system failure or older facilities, employees should be prepared to use their key cards or keys to exit the building;
- if safe to do so, activation of the fire alarm should be followed by immediately calling 911;
- caller should remain calm and provide requested emergency information to 911 call takers;
- attempts to fight a small controllable fire should be made only by those trained to do so; and
- upon exiting the building, immediately report to an assigned assembly area.

#### Fire Alarm Panel:

If a facility is equipped with a fire alarm panel, the closest employee should check for fire indications. This information should be provided to the 911 call taker if requested.

#### Building Emergency Coordinators:

Each facility will have a designated Building Emergency Coordinator. If the facility is under the control of a single command, the controlling commander will make this designation. If there is more than one, the commander of the largest contingent of employees will be the designated coordinator.

During an evacuation, the Coordinator will be stationed at the front of the facility. This area may serve as a temporary command post until the building is completely evacuated.

The ranking Emergency Coordinator on the scene will provide status reports, as available, to the Incident Commander as requested.

If not already on-site when an evacuation is activated, the following will be notified by the ranking Emergency Coordinator or a designee:

- the Sheriff;



Administrative and Operational Manual

September 12, 2022

- the Assistant Sheriffs; and
- all division commanders.

**Incident Commander:**

The Incident Commander shall be the ranking Sheriff's Office officer on the scene, or, in the case of a fire incident, the ranking Fire Official on the scene, who shall be responsible for:

- assisting personnel in exiting the building;
- directing, as safety allows, the closing of all windows and doors, checking all restrooms, copy rooms, etc., making certain that the assigned areas are clear, and reporting to the assigned assembly area;
- obtaining an accounting of personnel from the assigned areas.

**Public Meeting and Conference / Meeting Rooms:**

In the various conference and meeting rooms where non-continuous programs and where visitors and persons not normally assigned to work at a facility may be meeting, an announcement shall be made at the start of each program to notify occupants of the location of the exits to be used and the assembly area to which assigned. A diagram of the building with an evacuation route and assembly area will also be placed prominently near the exit.

**After Normal Business Hours:**

After normal business hours of 5:00 p.m. (1700 hours), responsibility for executing this plan will fall to the ranking Sheriff's Office personnel present in the facility at the time.

**Assembly Areas:**

Assembly areas are important for locating and accounting for all persons in the building at the time of an evacuation. Examples for larger facilities such as Headquarters are as follows:

Assembly Area "A" - First floor personnel will assemble at the North end of the parking area directly in front of the Charles County Detention Center.

Assembly Area "B" - Second floor personnel will assemble in the area directly in the front center of the Charles County Detention Center.

Assembly Area "C" - Third floor personnel will assemble in the South end of the parking area directly in front of the Charles County Detention Center.

**Sprinkler Connection:**

In some facilities, the fire department has a connection to a sprinkler system inside the facility. All personnel should be made aware of its location and all personnel should stay clear of this area so as not to impede the actions of the fire department.

**6-300.2 EVACUATION OF PERSONNEL**

When an emergency evacuation of a Sheriff's Office facility becomes necessary, the following procedures should be observed by all personnel:

- when an alarm sounds, stop all work and turn off all equipment;



## Administrative and Operational Manual

September 12, 2022

- remain calm and help others to remain calm;
- leave immediately, closing all windows and doors along the way;
- do not use elevators during building evacuations;
- exit by the nearest exit door and report to the designated assembly area;
- assist anyone injured and/or handicapped in evacuating the building;
- do not run, linger in entrance ways or walkways, and once outside, do not go back into the building for any reason;
- upon arrival at assigned assembly area, stay together as a group and allow area monitors to obtain an accountability report;
- do not leave the area until told to do so; leaving the area without notice may cause unnecessary risk for rescuers attempting to locate those missing; and
- do not re-enter the building until notified it is safe to do so.

**General Training:**

Supervisors of personnel who are assigned to a facility shall review this plan with them upon assignment. Select personnel shall receive training in the use of fire extinguishers.

**Drills:**

Fire / emergency evacuation drills will be conducted at least twice a year for each Sheriff's Office facility. At least once a year the La Plata Fire Chief will be invited to participate and evaluate the building emergency plan.

Fire / emergency alarms will be tested every two months in each facility.

**Building Diagrams:**

Building diagrams with evacuation routes and assembly areas will be placed prominently throughout the building.

## 6-301 FIRE PREVENTION AND EXTINGUISHERS

All employees shall be on the alert for fires and fire hazards. They shall eliminate such hazards if possible. Extinguishers are a first line of defense for the control of fire in its incipient stage. Should there be any doubt that any fire cannot be controlled with extinguishers, call the fire department and evacuate the building.

### 6-301.1 FIRE CLASSIFICATION AND EQUIPMENT

Fire protection equipment or devices shall not be tampered with, rendered inoperative, or used for any purpose other than fire protection.

Fire extinguishers of the appropriate type shall be placed where they are highly visible and easily accessible. They shall be prominently marked with their type, directions for their use, and date of last inspection.

All fire extinguishers shall be inspected on a regular schedule. Each shall carry a tag on which is recorded the inspection dates.

Fires are grouped into four general classifications, each of which can be extinguished by a particular agent. Because all types of extinguishing agents cannot be used on all types of fires, this classification makes it possible to determine and use the type of extinguisher best suited for fighting a particular type of fire.

**Class A:** Fires occurring in wood, paper, and rags are termed Class A fires. Fires in this classification will be effectively and safely extinguished by water or solutions containing water. This classification is primarily concerned with cooling or quenching the fire as water does. Multipurpose ABC or water-containing extinguishers should be used on these fires. Please note that electrocution may be





## Administrative and Operational Manual

September 12, 2022

possible if a Class A extinguisher is mistakenly used on an electrical fire.

**Class B:** Fires occurring in flammable liquids such as gasoline, oil, solvents, grease and similar substances are termed Class B fires. The agents required for extinguishing this type of fire are those which eliminate or dilute air by exclusion or blanketing, thereby creating a smothering effect, such as CO<sub>2</sub> or ABC.

**Class C:** Those fires occurring in electrical equipment and facilities such as motors, transformers, switches, etc., are termed Class C fires. The extinguishers used on Class C fires must be nonconductors of electricity and have a smothering effect such as CO<sub>2</sub> or ABC.

ABC fire extinguishers are your best defense against most fires.

**NOTE:** *Fire extinguishers should be the first choice for protection of all delicate, sensitive and expensive computers, electrical equipment, tapes and films. The discharged vapor rapidly blankets a fire and quickly penetrates difficult to see and hard to reach places. NOT to be used on Class A fires.*

**Class D:** Those fires where the fuel is combustible metal such as magnesium, sodium, zirconium, potassium and titanium are considered Class D fires. The extinguishers used must be the application of special powders such as Dry Graphite or Dry Sand.

## 6-301.2 PORTABLE FIRE EXTINGUISHERS

Portable fire extinguishers are primarily of value for immediate use on small fires. They have a limited quantity of extinguishing material and therefore must be used properly so this material is not wasted. Extinguishers are mechanical devices. In most cases they are high pressure vessels and must be treated with respect and handled with care. Fire extinguishers will be kept in their designated locations.

## 6-301.3 INSPECTION AND MAINTENANCE OF EQUIPMENT

Fire extinguishers will be replaced as soon as possible after use.

Maintenance requires a thorough check of the extinguisher. It includes hydrostatic testing (every five years), a thorough examination and necessary repair, recharging or replacement. Maintenance is conducted at intervals of one year or less or when the need is indicated by an inspection or after discharge.

Any fire extinguisher not fully charged or appearing to have some malfunction will be taken out of service immediately and replaced by one of the same type.

All outdoor fire extinguishers shall be encased or have a weatherproof tag.

Audible fire alarm systems will be checked at least once every two months.

## 6-301.4 TRAINING

All supervisors shall know the following information and encourage employees to be aware of:

- How to sound the fire alarm;
- The location of the nearest extinguisher to their work area, how to operate it and the type of fire on which it shall be used;



## Administrative and Operational Manual

September 12, 2022

- Location of the nearest exit to their work station.

### 6-301.5 FIRE ALARM AND EMERGENCY PROCEDURE

The first act upon discovery of flame, excess heat, or smoke in a building shall be to activate the fire alarm. The sounding of a fire alarm shall be treated as an extreme emergency and complete evacuation of the building is required. Notify 9-1-1.

During any real or practice emergency evacuation, operation of elevators is prohibited.

### 6-301.6 FIRE PREVENTION HOUSEKEEPING

Good housekeeping is essential to prevent fires. Combustible waste material such as paper, wood, cardboard boxes, oil soaked rags, paint covered rags, packing materials, rubbish, etc., shall not be allowed to accumulate but be disposed of promptly. Oil and paint rags shall be kept in metal containers with self-closing lids and emptied daily.

- Work with flammable liquids outdoors only or in an area that is provided with forced ventilation via enclosed electrical fixtures;
- All flammable liquids shall be stored in OSHA approved containers; AND
- All flammable liquids that are stored indoors are to be in OSHA approved cabinets with adequate ventilation.

One of the most important life safety features of any multi-story building is the closing off of vertical openings, such as at stairways. The vertical opening enclosures serve to delay the spread of fire and are vital in preventing the rapid flow of smoke, death-dealing gases, and super-heated air throughout the building. Such doors and fire doors shall not be blocked or wedged in the open position.

A list of all major fire hazards and potential ignition sources will be kept at all "Right To Know Stations."

### 6-301.7 EMERGENCY EXITS

To ensure timely evacuation of buildings in the event of an emergency, all interior and exterior exits shall be marked and exit signs illuminated at all times.

- Exterior exit doors must open out, contain panic hardware, and be in proper operating order at all times;
- Landings and stairs must be equipped with hand rails maintained in good condition;
- Exit routes must be adequately lighted;
- Floor surfaces, especially in hallways, must be kept clean, in good repair, and cleared of all items that may prove hazardous. Keep fire doors and exits free from all obstructions and closed at all times;
- Corridors in buildings are not to be considered as spaces available to any department for expansion or storage;

### 6-301.8 APPLIANCES

Heavy load appliances, including refrigerators, coffee makers, etc., should be connected directly to permanent



## Administrative and Operational Manual

September 12, 2022

outlets by the service cords attached to the appliances. Use of extension cords are subject to Safety and Inspections Officer approval. All coffee makers with automatic timing devices are prohibited.

### 6-301.9 FLAMMABLE LIQUID STORAGE AND HANDLING

Commercial cleaning fluids may present some fire or health hazards unless proper precautions are taken. Only those solvents which have been approved and recommended for use shall be used for cleaning purposes.

- Cleaning fluids shall not be used in confined areas unless adequate forced ventilation is provided;
- Only OSHA approved safety cans of not more than a five-gallon capacity, having a flash arresting screen, spring closing lid, spout cover, and so designed that it will safely relieve internal pressure when subjected to fire exposure, should be used for storing and transporting gasoline or other flammable liquids;
- Metallic contact shall be maintained when transferring gasoline or other flammable liquids from one metal container to another via grounding cables or other suitable apparatus;
- No smoking or open flames shall be allowed where flammable liquids are being used;
- Adequate fire extinguishing equipment shall be readily available when using flammable liquids;
- Avoid, to the extent possible, contact of cleaning fluids and solvents with the skin. Clothing contaminated by spillage of any cleaning fluid shall be removed promptly. Protective gloves of nonporous material shall be used in cases of excessive exposure and where skin sensitivity is noted. Skin protecting creams are also of value; and
- All parts cleaners shall be equipped with fusible plugs, so lids will close in the event of a fire.

### 6-310 HAZARDOUS / RADIOACTIVE MATERIALS AND WEAPONS OF MASS DESTRUCTION (WMD)

#### 6-310.1 DEFINITIONS

**Hazardous materials** - Substances or materials which, because of their chemical, physical or biological nature pose a potential risk to life, health or property if improperly released. A release may occur by spilling, leaking, emitting toxic vapors or any other process that enables the material to escape its container or otherwise enter the environment and create a potential hazard. Hazards are classified in the following terms:

- Explosives - substances which release pressure, gas and heat suddenly when they are subjected to shock, heat or high pressure.
- Flammable or combustibles - substances which are easy to ignite. Included in this category are oxidizers, which lend oxygen readily to support a fire, and reactive materials, which are unstable and may react violently if mishandled.
- Toxic materials - materials that can cause injury or death when they enter the bodies of living things. Such substances can be classified by chemical nature (for example, heavy metals and cyanides) or by toxic action (such as irritants, which inflame living tissue, and corrosives, which destroy or irreversibly change it). These materials can enter the body through inhalation, ingestion, absorption and open wounds.
- Biological agents - live microorganisms or toxins produced by agents that are capable of producing disease. These agents can enter the body through inhalation, ingestion, absorption and open wounds.



## Administrative and Operational Manual

September 12, 2022

- Radioactive materials - materials that release harmful radiation. These materials can enter the body through inhalation, ingestion, absorption and open wounds.

**Weapons of Mass Destruction (WMD)** - any explosive, incendiary, poison gas, bomb, grenade or rocket having a propellant charge of more than four ounces; any weapon involving a disease organism; and any weapon that is designed to release radiation at a level that is dangerous to human life. WMD's are divided into two categories:

- chemical / biological agents or radiological / nuclear materials (CBRN); and
- high yield explosive (E) materials.

CBRN weapons are designed to spread toxic chemical, biological, radiological or nuclear contaminants. E weapons are designed to cause massive destruction. Collectively they are known as CBRNE.

### 6-310.2 OFFICER RESPONSIBILITIES

In almost all cases, patrol officers will be the first responders to incidents involving radioactive / hazardous materials and weapons of mass destruction. Quickly identifying the problem is essential. Self-protection is also a top priority. A responder who becomes a victim only adds to the problem. While evaluating a scene, officers will consider all possibilities, including the possibility of multiple hazards. Recognizing and evaluating potential dangers is critical. Officers should take the time to adequately evaluate each situation before taking any action. Officers must attempt to isolate the problem and, if needed, request additional assistance immediately. Officers must act quickly to establish an outer perimeter and ensure that emergency access routes are maintained.

The most common type hazardous / radioactive materials incident that an officer is likely to encounter will involve traffic stops and vehicle accidents involving transport vehicles on Route 301. Only in exigent circumstances will a vehicle transporting radioactive or hazardous materials be stopped in a populous area. When necessary to stop such a vehicle, it should be followed or escorted to a more remote area and, if possible, moved from the highway. Prior to, or as soon as possible after making the stop, Communications shall be advised of the hazardous placard identification number(s) displayed on the vehicle. A supervisor shall be notified of the incident and additional assistance requested as needed.

When responding to any accident / incident involving possible hazardous / radioactive materials or WMD, assume that the area has been contaminated until it is verified that the hazardous material is secure. Considering all possibilities, including that of personal risk and contamination, attempt to rescue and remove persons from the affected area. Administer minimum first aid to sustain life, until professional medical assistance is available.

Establish an outer perimeter to restrict public access and to prevent any further damage or contamination. Minimize personal contact with possible contaminated surfaces, objects, clothing, etc. Avoid and prevent public contact with smoke, fumes and dust emanating from the impact area. Avoid eating, smoking or drinking in the contaminated area.

As necessary, evacuate the immediate area and arrange for the evacuation of any nearby areas. Make the appropriate notifications and request additional assistance as needed.

### 6-310.3 NOTIFICATIONS

Upon being notified of a verified accident, leak, spill or other incident involving hazardous / radioactive materials or WMD incidents, Communications personnel will immediately notify:

- the appropriate on-duty supervisor and commander;
- the Director of Emergency Services (per 3-160 MOU); and



## Administrative and Operational Manual

September 12, 2022

- the County Health Officer.

Additional local and outside agency support will be requested as determined by an on-scene supervisor or commander.

## 6-310.4 HAZARDOUS MATERIALS GUIDEBOOK

Each sworn member of this Agency is issued a guidebook entitled "Hazardous Materials," which will be carried in the member's assigned Agency vehicle. This guidebook was printed by the United States Department of Transportation for use by emergency personnel to serve as a ready reference as to initial actions to be taken to protect themselves and the general public immediately following an incident involving hazardous materials. The guidebook lists the materials by a four (4) digit identification number (displayed on placards or orange panels on the ends or sides of tanks, vehicles, and rail cars). Once the material is identified by identification number or name, go to the appropriate guide page and follow the information provided as to first aid and possible evacuation steps.

## 6-315 CHEMICALS / HAZARDOUS MATERIALS IN THE WORKPLACE

Chemicals / hazardous materials include pressurized gasses, explosives, flammable chemicals, and aerosols, gasoline, organic peroxides, oxidizers, and unstable reactive chemicals.

### 6-315.1 HAZARD COMMUNICATION STANDARDS

The Hazard Communication Standard (#1910.1200 App. E, OSHA Standards 29 CFR) is based on the concept that employees have both a need and a right to know the hazards and identities of the chemicals they are exposed to in the workplace. They also need to know what protective measures are available to prevent adverse effects from occurring.

The law requires employers to maintain a written plan which best describes how the standard will be implemented in that facility, along with a list of hazardous chemicals handled or stored in the workplace, which must be kept current and maintained for at least forty (40) years. The written plan must indicate who is responsible for the various aspects of the program in the facility, and where and how written materials will be made available to employees (i.e., notebooks in work areas, computer terminal with access). The employees must have access to the Material Safety Data Sheets themselves. The written plan must describe how the requirements for labels and other forms of warning, Material Safety Data Sheets, and employee information and training are going to be met in the facility.

### 6-315.2 POLICY AND PROCEDURES

A written Hazard Communication Plan is provided to each employee upon employment with the Charles County Sheriff's Office. A copy of the plan is available at each Right to Know Station within each of the Agency's facilities. This plan informs all employees how to gain access to the chemical information list and Material Safety Data Sheets (MSDS). It also describes how containers are labeled, an employee training program, the hazards associated with chemicals in unlabeled pipes, and the means the Agency will use to inform employees of the hazards of non-routine tasks.

Material Safety Data Sheets (MSDS) are provided at each Right to Know Station. An MSDS will be provided by the chemical manufacturer, importer and distributor. Each must obtain or develop a Material Data Safety Sheet for each hazardous chemical they produce or distribute and must submit those to purchasers at the time of the initial shipment. The Hazard Communication Standard also requires that the MSDS be updated by the chemical manufacturer or importer within three (3) months of learning of "new or significant information" regarding the chemical's hazard potential.

Agency personnel obtaining, ordering or storing materials for which a MSDS is required shall request and obtain the MSDS, which must be in English. Each time a MSDS is received, it should be checked thoroughly to make sure the following information is included:



## Administrative and Operational Manual

September 12, 2022

- A list of all hazardous ingredients that make up one percent (1%) or more of the substance, or one-tenth percent (.1%) or greater if the chemical is a carcinogen;
- the physical and chemical characteristics, including boiling point, vapor pressure, water solubility and normal odor and appearance;
- the physical hazards (i.e., fire, explosion, and reactivity potentials);
- the primary routes of entry, such as inhalation, swallowing, or through the skin;
- exposure limits set by OSHA;
- precautions for safe handling;
- emergency first aid procedures;
- the date of preparation;
- the name, address and phone number of the preparer or manufacturer.

Each MSDS that comes into custody of Agency personnel must meet these requirements. If it does not, a complete MSDS in writing shall be requested immediately from the manufacturer or distributor.

Division commanders / directors shall compile and maintain a Chemical Information List which shall contain the following information in alphabetical order according to common name, for each hazardous chemical stored or used in the workplace:

- the common name;
- the chemical name;
- location where stored or used;
- date added to list.

Every commander / director whose division uses or stores hazardous chemicals must keep a Chemical Information List and all MSDS at the Right to Know Station. A master copy of all MSDS forms, chemical information lists and written hazard communication plan will be provided to the Quartermaster's office.

### 6-315.3 MSDS / CHEMICAL LIST COMPILATION RESPONSIBILITY

Whenever substances containing potentially hazardous chemicals are ordered by the Quartermaster, he must obtain the MSDS from the manufacturer, and will maintain all original copies of MSDS. Copies of all MSDS will be supplied to all division commanders / directors. Division commanders / directors will maintain a current Right to Know Station for employee access with all appropriate MSDS. If there is not an MSDS on hand for a particular chemical used in a division, the division commander / director will notify the Quartermaster to obtain a copy, either from an original maintained at the Quartermaster's office or from the manufacturer / distributor.

Any Agency employee who purchases items or sends a purchase order for any item which would necessitate a MSDS, will make the request directly to the manufacturer / distributor for a MSDS for each item. The original MSDS will be forwarded to the Quartermaster.

Within thirty (30) days after a hazardous chemical is introduced into the workplace, the division commander / director shall add the hazardous chemical to the chemical information list. In compliance with Maryland Law, within fifteen (15) days after a commander / director prepares or revises a chemical information list, he shall submit a copy of the list to the Maryland Department of the Environment, Toxic Information Center.



## Administrative and Operational Manual

September 12, 2022

#### 6-315.4 LABELS AND OTHER FORMS OF WARNING

The chemical manufacturer or distributor must ensure that each container of hazardous chemicals is labeled, tagged or marked with the following information:

- the identity of the hazardous chemical(s);
- appropriate hazard warnings;
- name and address of the manufacturer or distributor.

The division commander / director is required to ensure that each container of hazardous chemicals in the workplace is labeled, tagged or marked with information giving the identity of the hazardous chemical and appropriate hazard warnings. The commander shall also maintain a description of the labeling system used, along with procedures to review and update label information when necessary. There is no requirement to label portable containers into which hazardous chemicals are transferred from labeled containers, and which are intended only for immediate use of the employee who performs the transfer.

#### 6-315.5 EMPLOYEE INFORMATION AND RIGHT TO KNOW

Division commanders / directors shall provide subordinates with information and training on hazardous chemicals in the workplace prior to the time of their initial assignment and whenever a new hazard is introduced to the work area. A Right to Know Station will be established in the immediate area of all copy machines at CCSO facilities. A separate Right to Know Station will be maintained in areas where there is no copier available and hazardous chemicals are stored.

Employees shall be informed of any operations in their work area where hazardous chemicals are present and the location and availability of the written hazard communication plan. This includes the Chemical Information List and the Material Safety Data Sheets.

#### 6-315.6 MARYLAND OCCUPATIONAL SAFETY AND HEALTH (MOSH) REGULATIONS

- An employee or designated representative may request access to the Chemical Information Lists or any Material Safety Data Sheet maintained in the work area;
- Supervisors will provide access to the requested information within one (1) working day;
- An employee may request a copy of the Chemical Information List or the MSDS and shall be provided with the copy or the means to make a copy within five (5) days after the request;
- If the supervisor fails to comply with either of these requests, the employee shall prepare a written request, through the chain of command, to the appropriate Assistant Sheriff requesting the information.

#### 6-315.7 TRAINING

The Charles County Sheriff's Office shall provide employees training and education designed to inform employees of:

- the existence and content of this program;



Administrative and Operational Manual

September 12, 2022

- the hazard communications methods used by this Agency;
- the rights an employee may exercise under this program;
- procedures for obtaining chemical information;
- the nature of the hazardous chemicals in the workplace;
- the appropriate control programs and protective measures regarding hazardous chemicals in the workplace;
- emergency procedures relating to hazardous chemicals in the workplace.

Division commanders / directors shall arrange training and education for:

- each new employee prior to initial assignment;
- all employees when additional information is made available.

Also, additional instruction will be provided whenever an employee:

- may be routinely exposed to additional hazardous chemicals;
- may be required to take special precautions;
- may potentially be subject to increased exposure due to changes in practices, equipment or the introduction of new hazardous chemicals in the workplace.

## 6-320 COMMUNICABLE DISEASES / BLOOD BORNE PATHOGENS

The purpose of this policy is to provide training and to establish guidelines to eliminate or minimize employee exposure to blood borne pathogens and to delineate procedures to be followed in the event of an exposure.

The Agency has implemented the Charles County Sheriff's Office Exposure Control Plan for Blood Borne Pathogens, to meet the OSHA Blood Borne Pathogens Standards, Codified as 29 CFR 1910.1030. OSHA Blood Borne Pathogens Standards are available upon request from the Exposure Control Officer, Human Resources.

### 6-320.1 DEFINITIONS

For purpose of this policy, the following shall apply:

- **ASSISTANT SECRETARY:** The Assistant Secretary of Labor for Occupational Safety and Health, or designated representative.
- **BLOOD:** Human blood, human blood components, and products made from human blood.
- **BLOOD BORNE PATHOGENS:** Pathogenic microorganisms that are present in human blood and can cause disease in humans. These pathogens include, but are not limited to, Hepatitis B Virus (HBV) and Human Immunodeficiency Virus (HIV).
- **BODY FLUIDS:** Liquid secretions, including blood, semen, breast milk and vaginal or other secretions that might contain these fluids such as saliva, vomit, urine and feces.
- **COMMUNICABLE DISEASE:** Those infectious illnesses that are transmitted through contact with the body fluids of an infected person.
- **BIOHAZARD CONTAINER:** A red puncture resistant container which is preprinted with "Biohazard (symbol) - Danger Infectious Waste." This container is leak proof.





Administrative and Operational Manual

September 12, 2022

- 
- **BIOHAZARD LABEL:** A fluorescent self-adhesive label which is preprinted with “Biohazard (symbol) - Danger Infectious Waste.”
  - **CONTAMINATED:** The presence or reasonably anticipating the presence of blood or other potentially infectious materials on any item or surface.
  - **CONTAMINATED SHARPS:** Any contaminated object that can penetrate the skin, including, but not limited to, needles, scalpels, broken glass, broken capillary tubes, etc.
  - **CONTAMINATED LAUNDRY:** Laundry which has been soiled with blood or other potentially infectious materials or which may contain sharps.
  - **DECONTAMINATION:** The use of physical or chemical means to remove, inactivate, or destroy blood borne pathogens on a surface or item to the point they are no longer capable of transmitting infectious particles and the surface or item is rendered safe for handling, use or disposal.
  - **DIRECTOR:** The Director of the National Institute for Occupational Safety and Health, U.S. Department of Health and Human Services, or designated representative.
  - **EXPOSURE CONTROL OFFICER (AECO®):** The Deputy Director, Human Resources is designated as the Exposure Control Officer for the Agency.
  - **EXPOSURE CONTROL PLAN PACKET:** Contains written procedures and reports to be completed by the employee, supervisor and attending physician following an exposure incident.
  - **EXPOSURE INCIDENT:** A specific eye, mouth, other mucous membrane, non-intact skin, or parenteral contact with blood or other potentially infectious materials that results from the performance of an employee’s duties.
  - **OCCUPATIONAL EXPOSURE:** Reasonably anticipated skin, eye, mucous membrane or parenteral contact with blood or other potentially infectious materials that may result from the performance of an employee’s duties.
  - **PARENTERAL:** Piercing mucous membranes or the skin barrier through such events as needle sticks, human bites, cuts and abrasions.
  - **STERILIZE:** The use of a physical or chemical procedure to destroy all microbial life, including highly resistant bacterial endospores.
  - **UNIVERSAL PRECAUTIONS:** An approach to infection control. According to the concept of universal precautions, treat all persons as if they may be infected and all human blood and body fluids as if they are infectious for HIV, HBV, and other blood borne pathogens.
  - **PERSONAL PROTECTIVE EQUIPMENT:** The Agency shall furnish, at no cost to the employee, appropriate personal protection equipment such as, but not limited to, gloves, hand towelettes, gowns, face shields or masks and eye protection, pocket masks, mouthpieces, and resuscitation bags or other ventilation devices. Such equipment is deemed “appropriate” only if the equipment does not permit blood or other potentially infectious material to pass through to reach the employee’s work clothes, street clothes, undergarments, skin, eyes, mouth, or other mucous membranes under normal conditions of use and for the duration of time which the protective equipment will be used. This equipment will be provided by the Agency to the employee, for protection against a hazard.
  - **HEPATITIS B VACCINATION:** The Hepatitis B Vaccination is available to all Agency employees.

**Administrative and Operational Manual****September 12, 2022**

Vaccinations are highly recommended to all employees who have occupational exposure to blood, within ten (10) working days of assignment, at no cost, at a reasonable time and place, under the supervision of a licensed physician or licensed health care professional, and in compliance with U.S. Public Health Service recommendations. Employees shall sign a declination form if they choose not to be vaccinated, but may later opt to receive the vaccine at no cost.

- **LEVEL I PERSONNEL:** Employees who are routinely exposed to blood borne pathogens or potentially infectious materials on a regular basis. Training is mandatory.
- **LEVEL II PERSONNEL:** Employees who may become exposed to blood borne pathogens or potentially infectious materials under certain circumstances. Training is mandatory.
- **LEVEL III PERSONNEL:** Employees who due to their job assignments will not become exposed to blood borne pathogens or potentially infectious materials. Training is offered, but not required.

**6-320.2 HIV INFECTION**

Acquired Immunodeficiency Syndrome (AIDS) is caused by a virus known as Human Immunodeficiency Virus (HIV). The virus is an infectious disease that alters the body's immune system. It infects and destroys certain white blood cells that fight infection and disease, and renders HIV infected persons vulnerable to a variety of serious ailments that thrive in this environment. The disease can be transmitted only through body fluids.

**6-320.3 HBV INFECTION**

Hepatitis is a disease that is transmitted principally by contact with infected body fluids. Unlike HIV, there is a safe and effective vaccine to prevent this disease. Training on HBV prevention will be given annually to all employees who have occupational exposure to blood.

**6-320.4 SMALLPOX INFECTION**

Smallpox is a serious, contagious and sometimes fatal disease for which there is no specific treatment. The only known prevention is vaccination. The disease is characterized by raised bumps on the face and body of the infected person. Generally, direct and prolonged face-to-face contact is required to spread the disease from one person to another. It may also be spread through direct contact with infected bodily fluids or contaminated objects, i.e., bedding and clothing. Smallpox is not known to be transmitted by insects or animals. Humans are its only known natural host.

**6-320.5 GENERAL PROGRAM MANAGEMENT**

The Deputy Director, Human Resources is designated as the Exposure Control Officer (ECO). The ECO is responsible for managing the Agency's Exposure Control Plan for Blood Borne Pathogens; he will establish, monitor and ensure compliance with vaccine schedules, post exposure evaluation with follow-up and record keeping, the Sharps Injury Log, and is responsible for the distribution of all plan revisions. In addition, the ECO will meet annually with the Commander, Training to review and update the Exposure Control Plan.

**6-320.5.1 TRAINING DIVISION RESPONSIBILITIES**

The Commander of Training is responsible for providing information and training to all employees having the potential of exposure to blood borne pathogens. Annual or additional training required, when modifications to tasks or procedures occur affecting an employee's occupational exposure, will be provided by Training.



## Administrative and Operational Manual

September 12, 2022

## 6-320.5.2 DIVISION COMMANDERS / DIRECTORS AND SUPERVISORS

Division commanders / directors and supervisors are responsible for compliance with the Exposure Plan. Division commanders / directors will ensure all employees have access to the Exposure Control Plan at all times. Supervisors will ensure proper exposure procedures are followed and a copy of the plan is available for review and use.

## 6-320.5.3 EMPLOYEES

Both sworn and civilian employees must:

- Know what task or group tasks they perform that may have an occupational exposure risk;
- Attend the blood borne pathogens training sessions;
- Employ good personal hygiene habits and use universal precautions during operational tasks where blood borne pathogens exposure may exist;
- Plan and conduct all operations in accordance with work practice controls.

## 6-320.5.4 QUARTERMASTER

The Quartermaster will provide the Agency with the required personal protective equipment.

## 6-320.5.5 AVAILABILITY OF THE EXPOSURE CONTROL PLAN PACKET TO EMPLOYEES

The Charles County Sheriff's Office Exposure Control Plan Packet will be available to employees at all times on the Agency's Intranet site.

## 6-320.6 EMPLOYEE CLASSIFICATION LEVELS

**Level I Personnel** - are those sworn and civilian employees who are routinely exposed to blood borne pathogens or potentially infectious materials on a regular basis (i.e., patrol officers, investigators, Forensic Science Section personnel, correctional officers, etc.). The following job classifications meet the criteria for Level I Personnel:

- Sworn law enforcement officers of the rank of Lieutenant and below, assigned to:
  - Patrol Operations;
  - Special Services Division;
  - Special Operations Division;
  - Criminal Investigations Division;
  - Court Security;
- Correctional officers, assigned to:
  - Detention Center
- Court Holding;
  - Court Security;
  - Alternative Sentencing;
- Civilian employees, assigned to:



## Administrative and Operational Manual

September 12, 2022

- the Forensic Science Section as Forensic Science Technicians.

**Level II Personnel** - are those sworn and civilian employees who may become exposed to blood borne pathogens or potentially infectious materials under certain circumstances. Such circumstances may include, but are not limited to, assisting with the following: altercations, accidents and crime scenes. These employees are not normally subject to front line exposure, but could be called upon in emergency situations. The following job classifications meet the criteria for Level II Personnel:

- Sworn law enforcement officers of the rank of Lieutenant and above;
- Sworn law enforcement officers assigned to the Office of the Sheriff;
- Correctional officers assigned to the administrative support staff;
- Data Processing Clerk and Administrative Secretary to Corrections Division;
- Latent Print Specialists and civilian employees of the Forensic Science Section other than Forensic Science Technicians.
- Forensic Chemists
- Background Investigators

**Level III Personnel** - are those civilian employees who because of their job assignments will not become exposed to blood borne pathogens or potentially infectious materials. The following job classifications meet the criteria for Level III Personnel:

- Civilian employees assigned to administrative, administrative support and clerical duties;
- Employees assigned to the Communications section.

Training is offered and encouraged, but it is not mandatory.

## 6-320.7 TRAINING AND EDUCATION

All Level I and Level II employees shall participate in an additional education and training program.

The education and training program shall include general information regarding Human Immunodeficiency Virus (HIV), Hepatitis B Virus (HBV), and other blood borne pathogens.

The training shall be provided within ten (10) days of assignment to tasks where occupational exposure may occur and at annual mandated in-service training.

Additional training shall be provided when modification of tasks or policy occur.

The training programs shall consist of the following:

- A copy of the Agency's policy / exposure control plan to be placed in the Administrative and Operational Manual;
- A general explanation of the epidemiology and symptoms of blood borne diseases;
- An explanation of the modes of transmission of blood borne pathogens;
- An explanation of the Agency's Exposure Control Plan Packet, to include instructions of procedures to follow should an exposure incident occur, and medical follow-up that will be made available;
- An explanation of the appropriate methods for recognizing tasks and other activities that may involve exposure to blood and other potentially infectious materials;



## Administrative and Operational Manual

September 12, 2022

- An explanation of the use and limitations of methods that will prevent or reduce exposure, including appropriate engineering controls, work practices and personal protective equipment;
- Information on the types, proper use, location, removal, handling, decontamination and disposal of personal protective equipment;
- Information on the Hepatitis B vaccine, including information on its efficacy, safety, method of administration, benefits of being vaccinated and that the vaccine and vaccination will be offered free of charge;
- An explanation of the signs and labels and/or color coding used to distinguish items contaminated; and
- An opportunity for interactive questions and answers with the person(s) conducting the training session, in accordance with OSHA standards.

### 6-320.8 PERSONAL PROTECTIVE EQUIPMENT

The Agency shall provide to all Level I and Level II sworn law enforcement officers a personal protective kit which shall be immediately accessible for use while on duty. The kit will consist of the following items:

- One (1) pair of disposable coveralls;
- Two (2) pairs of latex disposable gloves;
- One (1) pair of disposable goggles;
- Two (2) disposable surgical masks;
- One (1) rescue mask with CPR valve;
- One (1) bottle of liquid germicidal cleaner;
- Two (2) syringe safety containers; and
- Two (2) biohazard bags with twist ties.

The Agency shall provide to all Level I and Level II Correctional Officers a personal protective kit, consisting of the following items:

- One (1) pair of latex disposable gloves;
- One (1) disposable face mask with mouthpiece; and
- One (1) bottle of liquid germicidal cleaner or two (2) antimicrobial towelettes.

The Agency shall provide body fluid spill kits (one spill kit is capable of handling three separate spills) containing the following items:

- Three (3) containers of encapsulating powder;
- One (1) spray bottle containing disinfectant;
- Three (3) disposable face masks with visor;
- Six (6) pairs of latex disposable gloves;
- Nine (9) antimicrobial towelettes;
- Three (3) pairs of disposable coveralls, with hoods and boots;
- Three (3) rescue masks with CPR valve;
- Three (3) 12"x15" zip-lock bags;
- Three (3) biohazard bags; and
- Six (6) scoops.

Spill kits shall be maintained at the following locations or sites:



Administrative and Operational Manual

September 12, 2022

- Clerk area at the La Plata, Indian Head and Waldorf District Stations;
- Crime Laboratory;
- Holding cell area at Headquarters;
- Work Release facility office;
- Food service area;
- Medical treatment room;
- Booking / Intake area;
- Main housing post;
- Female housing post;
- Corrections reception post;
- Courthouse Security Station;
- Property / Evidence storage areas;
- Quartermaster's Office; and
- Judicial Services.

Disposable equipment shall not be washed or decontaminated for multiple use. Disposable equipment shall be replaced as soon as practical when contaminated or damaged.

Gloves shall be worn when it can be reasonably anticipated the employee may have hand contact with blood or other potentially infectious materials and when handling or touching contaminated items or surfaces.

Masks and eye protection shall be worn whenever splashes, spray, spatter, or droplets of blood or other potentially infectious materials may be generated and eye, nose or mouth contamination can be reasonably anticipated.

Liquid germicidal cleaner or disposable towelettes shall be used when hand washing facilities are not feasible. Hands shall be washed with soap and running water as soon as practical.

Resuscitation equipment shall be used during mouth-to-mouth resuscitation.

Disposable uniforms shall be worn in instances when gross contamination can reasonably be anticipated.

Syringe-safety containers shall be used to secure any syringe or sharp object recovered.

- Only one syringe shall be placed in each container.
- If recovered syringe is evidence, officer shall follow property and evidence procedures outlined in Chapter 4, Section 500 of the Administrative and Operational Manual.
- If recovered syringe is not evidence, the officer shall complete Property Report Form #60 and place property into a sharps biohazard container at any Sheriff's Office facility.

The encapsulating powder and spray disinfectant shall be used to clean up spills.

The spray disinfectant or a mixed solution consisting of one (1) part household bleach to ten (10) parts water is used to decontaminate equipment and work surfaces.

### 6-320.9 EQUIPMENT ISSUE AND REPLACEMENT

Personal protective equipment for affected employees and all Agency facilities shall be maintained by the Quartermaster.

It shall be the responsibility of the individual employee to contact the appropriate source for equipment replacement.



## Administrative and Operational Manual

September 12, 2022

When equipment is used for the kits maintained at the locations listed elsewhere in this policy, it shall be the responsibility of the employee using the equipment to notify his supervisor, who shall obtain replacements.

## 6-320.10 STANDARDS FOR WEARING PROTECTIVE EQUIPMENT

### Prevention:

- In order to minimize potential exposure to communicable disease, employees should assume that all persons are potential carriers of a communicable disease.
- All employees shall utilize universal precautions to prevent contact with body fluids.
- Personal protective equipment shall be worn when handling any persons, clothing or equipment with body fluids on them, and /or at any time when the potential of being splashed with body fluids exists.
- Plastic mouthpieces or other authorized barrier / resuscitation devices shall be used whenever CPR or mouth-to-mouth resuscitation is performed.
- An employee may elect not to use personal protective equipment under the following circumstances:
  - In the employee's professional judgment, in the specific instance, the use of the protective equipment would prevent the delivery of health care or public safety services or would pose an increased hazard to the safety of the employee or others.
  - If an employee does not use personal protective equipment due to his professional judgment, the circumstances shall be investigated by the employee's on-duty supervisor. The completed investigation shall be forwarded to the Sheriff via chain of command for action and disposition.
- All sharps, such as knives, scalpels and needles, shall be handled with extraordinary care, and should be considered contaminated items.
  - Leather gloves should be worn when searching for or handling sharp instruments;
  - Employees shall not place their hands in areas where sharp instruments might be hidden. An initial visual search of the area should be conducted, using a flashlight where necessary;
  - Needles shall not be recapped, bent, broken, removed from a disposable syringe or otherwise manipulated by hand;
  - Needles shall be placed in a puncture-resistant container.
- Eating, drinking, smoking, applying cosmetics or lip balm and handling contact lenses are prohibited in work areas where there is a reasonable likelihood of occupational exposure.
- Blood and other potentially infectious materials shall be placed and stored in biohazard containers.
- Employees are prohibited from keeping food and drink in or on refrigerators, freezers, shelves, cabinets, etc., where blood or other potentially infectious materials are present.
- All procedures involving blood or other potentially infectious materials shall be performed in such a manner as to minimize splashing, spraying, spattering and generation of droplets of these substances.
- If outside contamination of the primary container occurs or the specimen punctures the primary container,



## Administrative and Operational Manual

September 12, 2022

the primary container shall be placed in a second puncture-resistant container, which prevents leakage during handling, processing, storage, transport or shipping. The second container shall be biohazard labeled.

**Sanitation Procedures:**

- Hand washing facilities are available at all district stations and the Detention Center. Employees shall wash hands and any other affected skin thoroughly with soap and water immediately, or as soon as feasible, following contact with blood or other potentially infectious materials.
- The Agency shall provide antiseptic towelettes or liquid germicidal cleaner for use where hand washing facilities are not feasible.
- When antiseptic towelettes or liquid germicidal cleaner is used, employees shall wash their hands with soap and running water as soon as possible;
- Employees shall wash their hands immediately or as soon as possible after removal of disposable gloves or other protective equipment.
- Equipment which may become contaminated with blood or other potentially infectious materials shall be decontaminated or sterilized as necessary.
- Contaminated work surfaces shall be decontaminated with an appropriate disinfectant (a diluted household bleach solution of one (1) part bleach to ten (10) parts water) at the following times:
  - After completion of procedures;
  - Immediately or as soon as feasible when surfaces are overtly contaminated by blood or other potentially infectious materials;
  - At the end of the tour of duty if the surface may have become contaminated since the last cleaning.
- All bins, pails, cans, and similar receptacles intended for reuse, which have a reasonable likelihood for becoming contaminated with blood or other potentially infectious materials, shall be inspected and decontaminated on a regularly scheduled basis and cleaned and decontaminated immediately, or as soon as feasible, upon visible contamination by the responsible employee.
- Personnel assigned to clean up serious body fluid spills should wear disposable uniforms, disposable gloves, eye protection and masks.
- All contaminated clothing should be carefully removed as soon as practical and laundered with detergent in water at least 160 degrees Fahrenheit for twenty-five (25) minutes.
- Patrol vehicles and equipment contaminated with body fluids shall be immediately decontaminated. To accomplish this, the officer will contact Fleet Management to coordinate decontamination services performed by a contracted provider.
- All disposable equipment, cleaning materials or items contaminated with body fluids, shall be placed in a biohazard container and disposed of in accordance with state law provisions for disposal of biologically hazardous waste material.

**6-320.11 IMMUNIZATIONS - GENERALLY**

Presently there are safe, effective vaccines available for the prevention of certain communicable diseases.





**Administrative and Operational Manual**

**September 12, 2022**

Upon recommendation by the U.S. Public Health Service and in coordination with the Charles County Health Department, vaccinations will be made available to the following persons at no cost:

- All Level I and Level II employees after receiving the required training;
- All Level I and Level II employees within ten (10) working days of initial assignment where exposure to blood borne pathogens or other potentially infectious materials may occur; and
- Any other employee who wishes to participate.

**EXCEPTIONS:**

- The employee has previously received a complete vaccination series against the disease for which the vaccine is being offered;
- The employee has been vaccinated for the particular disease within the recommended time frame, based on recommendations by the Centers for Disease Control.
- Testing has revealed that the employee is immune to the disease being vaccinated against; or
- The vaccine should not be taken for medical reasons.

The Agency shall not make participation in a pre-screening program a prerequisite for receiving vaccinations.

Any employee who declines to receive any vaccination shall complete a Charles County Sheriff's Office Vaccine Consent/ Declination Form #39.

If the employee initially declines the vaccination for a specific disease, but at a later date decides to accept vaccination, the Agency shall make available the vaccination at that time.

If a routine booster dose(s) of any vaccine is recommended by the U.S. Public Health Service at a later date, such booster dose(s) shall be made available by the Agency.

Persons with certain health conditions are at risk of serious side effects from vaccines and should be certain to fully and accurately answer any pre-vaccination questionnaires. The risk from diseases generally far outweighs the risk from their vaccines. Persons who have been directly exposed should be vaccinated regardless of other health conditions which may be present if post-exposure vaccination is within medical protocol. At no time will the Agency require an employee to receive a vaccination.

Dependent upon the risks involved and the potential contagiousness of a particular disease, the Agency may make the vaccination available to members of the employee's immediate household.

The vaccines and vaccinations shall be administered by a licensed physician or licensed health care professional.

As safe and effective vaccines for serious diseases become available, the Agency will evaluate the advisability of providing them to employees.

**6-320.12 BIOHAZARD CONTAINERS, LABELS AND SIGNS**

Warning labels shall be affixed to containers of regulated waste, SHARPS containers, refrigerators and freezers containing blood or other potentially infectious materials, and other containers used to store, transport or ship blood or other potentially infectious materials.

**Administrative and Operational Manual****September 12, 2022**

The Agency shall post signs at the entrance to work areas where potentially infectious material may be present (i.e., Forensic Science Section, Property Held, Medical, etc.). The signs shall bear the biohazard symbol and contain the following information:

- Name of infectious agent;
- Special requirements for entering the area (i.e., mask, goggles, disposable uniform, etc.); and
- Name and address of responsible person.

Biohazard labels shall be fluorescent orange or orange-red or predominantly so with lettering or symbols in a contrasting color.

Blood or other potentially infectious materials shall be placed and stored in a biohazard container which prevents leakage during collection, handling, processing, storage, transport or shipping.

If outside contamination of the primary container occurs or the specimen punctures the primary container, the primary container shall be placed in a second puncture resistant container. The second container shall be biohazard labeled.

All contaminated waste shall be placed in a biohazard bag and deposited in a container located at:

- D1-La Plata District Station – Evidence/ Property Held room
- D2-Bryans Road District Station – Squad room and Evidence/ Property room
- D3/4-Waldorf District Station – One near the interview room, another in the Evidence/ Property Held room and one under the front desk in the Clerk's Office.
- Detention Center - Medical room; and
- Forensic Science Section- Evidence Bay.

A Property Held Form indicating the origin and type of waste should accompany the waste.

**6-320.13 DISPOSAL OF CONTAMINATED WASTE**

Contaminated waste located at all district stations will be taken to the Forensic Science Section during the evening shift prior to pick-up day. The appropriate district / shift commander will ensure this task is completed. The Property Held form should be forwarded to the Forensic Science Section Deputy Director.

Contaminated waste will be removed weekly by the contracted certified hauler.

The certified hauler shall provide the medical staff with a receipt and replacement containers. The receipt shall be maintained on file.

**6-320.14 POST EXPOSURE EVALUATION AND FOLLOW-UP**

If an employee comes in contact with blood, other body fluids, or stuck by a needle he shall:

- Wash the affected area immediately;
- Report the incident immediately to his respective supervisor;
- Obtain an Exposure Control Plan Packet and, together with the Supervisor, complete all appropriate forms.
- Be examined by a licensed medical authority immediately for appropriate medical evaluation, treatment and follow-up.

The Agency shall make available to the exposed employee a confidential medical evaluation and follow-up through



Administrative and Operational Manual

September 12, 2022

procedures and forms as outlined in the Exposure Control Plan Packet.

The Agency shall ensure the health care professional evaluating an employee after an exposure incident is provided the following (forms for the notification are included within the Exposure Control Plan Packet):

- A copy of the Occupational Safety and Health Administration, 20 CFR, Part 1910.1030, Occupational Exposure to Blood Borne Pathogens; Final Rule. (Upon request made to the ECO);
- A description of the exposed employee's duties as they relate to the exposure incident;
- Documentation of the route(s) of exposure and circumstances under which the exposure occurred; and
- Identification and results of the source individual's blood testing, if available.

The source individual's blood shall be tested as soon as practical and after consent is obtained in order to determine HBV and HIV infection. If the source individual is taken to the hospital, the officer who has the exposure needs to also go and notify hospital staff about the exposure and that the exposure happened to a Public Safety Worker.

If consent is not obtained voluntarily, the Agency shall seek a court order through the State's Attorney's Office, by contacting the Office of General Counsel.

When the source individual is already known to be infected with HBV or HIV, testing of the source individual shall not be required.

Results of the source individual's blood test or previously established status shall be made available to the exposed employee, and the employee shall be informed of applicable laws and regulations concerning disclosure of the identity and infectious status of the source individual.

The exposed employee's blood shall be collected as soon as practical and tested after consent is obtained.

## 6-320.15 RECORDS MAINTENANCE

### Medical Records:

The Agency shall establish and maintain an accurate record for each employee with occupational exposure. They shall be maintained by Human Resources, and shall be kept separate from the employee's personnel file. This record shall include:

- Employee's name and social security number;
- Copy of the employee's Hepatitis B Vaccination status including the dates of all Hepatitis B vaccinations;
- A copy of all results of examinations, medical testing and follow-up procedures;
- A copy of the health care professional's written opinion; and
- A copy of the information provided to the health care professional detailing the circumstances surrounding the employee's exposure.

Human Resources will maintain a SHARPS Injury Log which documents all injuries incurred by employees who have been stuck with needles or sharp objects possibly infected with a biohazard.

The Agency shall maintain employee medical records for a minimum period of thirty (30) years after the duration of



## Administrative and Operational Manual

September 12, 2022

the employee's employment.

Employee medical records shall be kept confidential and not disclosed or reported to anyone without the employee's written consent.

Employee medical records concerning an exposure shall be provided to the following upon request for examination and copying:

- The subject employee;
- The Director;
- The Assistant Secretary;
- Anyone having written consent of the subject employee; and
- The Agency's ECO.

**Training Records:**

Employee Training records shall be maintained by Training Division in the Employee Training File for a minimum period of three (3) years from the date on which the training occurred.

Program records of training will be maintained at the origin of training. In this case the Program Records will be maintained by the Southern Maryland Criminal Justice Academy, and consist of the content and summary of the training session and the following information:

- Dates of the training sessions;
- Names and qualifications of persons conducting the training; and
- The names and job titles of all persons attending the training sessions.

The employee's training records shall be made available to the following upon request for examination and copying:

- The subject employee;
- Anyone having written consent of the subject employee;
- The Director;
- The Assistant Secretary; and
- The Agency's ECO.

**6-350 ANIMAL BITE CASES – RABIES EXPOSURE**

The Environmental Health Division of the Charles County Department of Health has the responsibility for monitoring incidents of warm-blooded animal bites and/or possible exposures to rabies in order to determine if there has been, or there is a likelihood of, a spread of rabies. Environmental Health is a part of the Maryland Department of Health, with offices in White Plains.

The CCSO will assist Environmental Health by taking a report of the circumstances surrounding an exposure incident. The Health Department's form titled "Animal Contact Report And Rabies Quarantine Agreement" shall be used for this purpose. In addition to reporting animal bites, this form shall be used to report any other case where the rabies virus may have been transmitted.

The patrol officer who responds to the exposure complaint shall initiate the Contact Report. In addition to the report, the responding officer will request the Communications Section dispatcher to forward the call sheet to Animal Control Services.

The report shall be completed, and submitted to a patrol supervisor prior to the end of the reporting officer's tour of duty. In the event that the report cannot be completed, it shall be turned over to the on-coming district supervisor, who shall assign an officer to complete the report. In these cases, the Contact Report may be passed on by the

**Administrative and Operational Manual****September 12, 2022**

district supervisor / commander for up to 48 hours, if:

- the owner is known; and
- the animal is contained; and
- it is believed that the Contact Report will be successfully served upon the owner within the 48-hour period.

In the event the exposure animal, or its owner, cannot be located by the patrol officer, or the owner refuses to sign the report assuming responsibility for confining the animal, Animal Control and the Environmental Health Division shall be notified by the Communications Section, immediately. The Patrol operations commander / designee shall be responsible for record keeping and forwarding of the original report to the Environmental Health Division. The Records Management Section will maintain the Records copy. The Communications Section Supervisor shall maintain current call-out information for the Environmental Health Division in the event an officer needs support or information during non-business hours.

**6-350.1 CUSTODY OF ANIMAL**

When officers are investigating an animal exposure complaint, and the animal is not vicious or dangerous, the officer may elect to allow the owner to quarantine the animal if the owner can provide adequate containment. Quarantine may only occur within Charles County. If the owner cannot provide a quarantine location within the County, the animal must be turned over to Animal Control Services for quarantine. In the case of owner quarantine, the owner must sign the ten (10) day quarantine agreement. The quarantine is then monitored by the Environmental Health Division. If no quarantine containment is available, Animal Control is summoned to take custody of the animal.

**6-350.2 PERSONS APPREHENDED / ARRESTED WITH ANIMALS**

When a person is apprehended, arrested or otherwise detained and the person is in possession or control of an animal, and there is no other individual who will take responsibility for the animal, the officer will call Animal Control Services for removal of the animal. The officer will document the call to Animal Control Services on the Arrest Record or other appropriate Agency report.

**6-350.2.1 LIVE, INJURED OR DEAD DOMESTIC ANIMALS INVOLVED IN MOTOR VEHICLE CRASHES**

If a domestic animal is a passenger in a motor vehicle involved in a crash, and

- the occupants of that vehicle are incapacitated; or
- otherwise incapable of maintaining custody of the animal; and
- there is no other individual who will take responsibility for the animal; then
- the officer responding to the crash will notify Animal Control Services to respond to assume custody of the animal. If necessary because of the time of day or day of week, the officer may contact the Communications Section Supervisor who will notify the call-out Animal Control Officer.

**6-350.3 DEAD ANIMALS - NOTIFICATION**

When an officer encounters a situation involving a dead animal (other than road kill with no human contact), the officer will request notification of the Environmental Health Division, providing the location and description of the animal. Officers will request immediate removal of animals when there is evidence that indicates the presence of rabies. If the property owner is present, the officer will instruct the property owner to keep persons and pets away





[REDACTED]

[REDACTED]

[REDACTED]

[REDACTED]

[REDACTED]

[REDACTED]

[REDACTED]

[REDACTED]

[REDACTED]

[REDACTED]

[REDACTED]

[REDACTED]



Administrative and Operational Manual

September 12, 2022

[Redacted text block]

[Redacted text block]

[Redacted text block]

[Redacted text block]

[Redacted text block]

[Redacted text block]

[Redacted text block]

[Redacted text block]

[Redacted text block]

[Redacted text block]

[Redacted text block]

[Redacted text block]

[Redacted text block]





Administrative and Operational Manual

September 12, 2022

[Redacted text block]

[Redacted text block]

[Redacted text block]

[Redacted text block]

[Redacted text block]

- [Redacted list item]
- [Redacted list item]
- [Redacted list item]
- [Redacted list item]
- [Redacted list item]
- [Redacted list item]

[Redacted text block]

[Redacted text block]

[Redacted text block]

[Redacted text block]



Administrative and Operational Manual

September 12, 2022

[Redacted text block]

- [Redacted list item 1]
- [Redacted list item 2]
- [Redacted list item 3]

[Redacted text block]

[Redacted text block]

[Redacted text block]

[Redacted text block]

[Redacted text block]

[Redacted text block]

[Redacted text block]

[Redacted text block]



Administrative and Operational Manual

September 12, 2022

[REDACTED]

[REDACTED]

- [REDACTED]
- [REDACTED]
- [REDACTED]
- [REDACTED]
- [REDACTED]
- [REDACTED]

[REDACTED]

[REDACTED]

- [REDACTED]
- [REDACTED]
- [REDACTED]
- [REDACTED]
- [REDACTED]
- [REDACTED]

[REDACTED]

- [REDACTED]
- [REDACTED]
- [REDACTED]
- [REDACTED]
- [REDACTED]

[REDACTED]

[REDACTED]

[REDACTED]

[REDACTED]



Administrative and Operational Manual

September 12, 2022

- [REDACTED]
- [REDACTED]
- [REDACTED]
- [REDACTED]

[REDACTED]  
[REDACTED]  
[REDACTED]

[REDACTED]  
[REDACTED]

- [REDACTED]
- [REDACTED]

[REDACTED]  
[REDACTED]

[REDACTED]  
[REDACTED]  
[REDACTED]

[REDACTED]  
[REDACTED]  
[REDACTED]  
[REDACTED]

[REDACTED]  
[REDACTED]  
[REDACTED]

[REDACTED] ■  
[REDACTED]  
[REDACTED]



## Administrative and Operational Manual

September 12, 2022

**6-500 BUILDING, OFFICE AND CLERICAL SAFE WORKING PRACTICES****6-501 GENERAL RULES FOR SAFETY**

The following rules for safety should be followed by all Sheriff's Office employees while at the work place:

- Tripping hazards such as chairs, waste baskets, cords, etc., shall not be left in aisles;
- Do not carry pointed or sharp objects such as screwdrivers, open blade knives, pencils, or scissors in clothing pockets with points unprotected;
- Care shall be used when passing through or closing doors, particularly those with glass panels. Caution shall be used when entering an area marked "Wet Floors";
- Extension cords, telephone lines, etc., shall not be placed across traveled areas unless covered with an approved device;
- Employees shall limit the number of horizontally stacked publications and materials, on book shelves: corrective action includes reviewing the materials, discarding the unneeded, and safely stacking retained materials;
- Planters shall not be hung on overhead lights;
- Plants, pictures or any other ornaments placed on top of room dividers or walls shall be anchored securely;
- Utilization of extension cords shall be minimized to avoid electrical fires and/or tripping hazards;
- Adequate lighting shall be provided for all desks and work areas;
- Approved type of ladders, step stools or other safe supports shall be used to reach material on high shelves or at other elevations. (All ladders must meet the requirements set forth in OSHA 29 CFR 1926.1050);
- Employees not physically capable, shall not lift or carry heavy office machines such as typewriters, computer equipment, etc. They shall also not lift or carry large quantities of ledgers, paper or card supplies. Moving carts and tables shall be used and assistance requested as necessary.
- Portable stands for typewriters or other office machines shall be designed with sufficient size and stability to prevent easy tipping or breakage. Wheels shall be lubricated and replaced when worn;
- Only space heaters that have been tested and approved by Underwriters Laboratory may be used.

**6-502 HOUSEKEEPING**

Good housekeeping is recognized as being fundamental to safety. It is a very definite factor in the reduction of hazards, in the elimination of accidents and in the prevention of fires.

Good housekeeping requires a place for everything and everything in its place.



Administrative and Operational Manual

September 12, 2022

### 6-502.1 SAFE HOUSEKEEPING PRACTICES

Good housekeeping practices begin with simple rules which create a safe working environment:

- Do not allow waste to accumulate on desks, tables, or floors. Deposit trash and refuse into proper containers;
- Pick up broken glass with a brush and dust pan, not bare hands;
- When disposing of broken glass, wrap up the pieces in thick newspaper and identify the package;
- Floors and stairways are to be kept clean and clear of all obstructions;
- Paper cutters shall be in a locked position whenever they are not in immediate use;
- Areas having carpet covering will be routinely surveyed for rips, tears or other defects that could cause slip / trip and fall hazards;
- Cooperate in keeping change rooms, toilet rooms, drinking facilities and areas containing first aid equipment in a clean, dry and sanitary condition. They are provided for your convenience and health;
- Report all safety hazards, if they cannot be fixed on the spot, such as:
  - Any broken or loose wire;
  - Tables or chairs (needing repair or removal);
  - Broken windows or glass of any kind;
  - Water pipes or fixtures that are broken;
  - Wet and/or broken ceiling tiles;
  - Any strange smells (example: gas leak in kitchen);
  - Objects stacked near the ceiling or in the area of a sprinkler head.

### 6-502.2 OFFICE MACHINES

Office machines shall not be placed on the edge of a table or desk. Machines that tend to creep during operation should be secured either directly to the desk or table or placed on a non-slip pad. Heavy equipment shall be placed against walls or columns.

Electrical machines and connections shall not be operated on damp floors.

Make sure the machine is off and unplugged before adjusting, lubricating, or cleaning.

### 6-502.3 DESKS AND TABLES

- Only shatterproof glass or plastic with beveled edges shall be used on desk tops.
- Manual pencil sharpeners shall be mounted on desks or tables so they do not protrude.
- Desks and tables located on tile floors shall have rubber feet on them to prevent creeping.

### 6-502.4 CHAIRS



## Administrative and Operational Manual

September 12, 2022

- Extreme care shall be taken by persons tilting back in swivel chairs to which they are not accustomed.
- The seats on swivel chairs shall not be raised so high as to contribute to overbalancing.

### 6-502.5 FANS

- Check fans regularly to make sure that the guards are not defective and that blades are secure.
- All accessible fans shall be cover-guarded to prevent injury.
- Floor fans shall not be placed in locations where they will be present tripping hazards.

### 6-502.6 FILE CABINETS

Filing cabinets shall be filled from the bottom drawer up or bolted at the back to prevent overbalance. Filing drawers must be closed unless in immediate use to prevent falling over an open drawer or lifting one's head and striking a sharp corner. Desk drawers shall also be kept closed to eliminate accidents.

- Heavy materials shall be put in the bottom drawers, lighter materials in the top drawers.
- Pull only one drawer out at a time.
- File cabinets shall be checked periodically for burrs and sharp edges.

### 6-502.7 DOORS AND WINDOWS

Every glass door shall have some conspicuous design in paint or decal, about 4 1/2 feet above the floor and centered on the door so that people will not walk into it. Solid doors present a hazard when being approached from both sides at the same time, because one person can be struck when the door opens. Employees shall be aware of this hazard and approach a solid door in the proper manner, that is, out away from the path of an opening door. Any door that opens directly into the path of traffic shall be opened slowly. Operable windows must open and close freely. Do not force open if window is stuck.

## 6-520 PROTECTIVE EQUIPMENT AND SAFE WORKING PRACTICES

An employee may be injured through absorption, inhalation, noise, or physical contact. Therefore, the Sheriff's Office shall provide protective equipment for the eyes, face, head, ears and extremities wherever a hazard exists. Employees shall use personal protective equipment (PPE) whenever a hazard exists or when directed to do so by a supervisor.

When the use of personal protective equipment has been specified for hazardous work, its use is mandatory as a condition of employment. Supervisors will be held accountable for employees allowed to work out of compliance. Enforcement can be made easier by educating employees on the reasons for using or wearing the protective equipment and the possible injuries that can result when the need is ignored. The monthly review of injuries by the Sheriff's Office Safety Officer should place emphasis on those that resulted from failure to use protective equipment.

This equipment shall not be substituted for engineering controls that can eliminate or minimize hazards.

### 6-520.1 SAFETY PRACTICES

The supervisor shall see that all necessary safety equipment, precautionary devices, flags, signs, barricades and other safety items deemed pertinent to a particular task are available and in use at all times.

All equipment will be operated in a safe manner with regard to operator safety, employee safety and public safety.



Administrative and Operational Manual

September 12, 2022

Any personal protective safety equipment needed to operate equipment shall be worn: hard hats, ear protection, safety glasses, steel-toed shoes, gloves, etc.

Supervisors will instruct employees in the proper use and operation of equipment before any employee operates such equipment. Equipment use shall conform to that stated in the Operators Manual.

Clean all equipment, assure it is in proper working condition before each use, after each use and before storage.

Every employee shall be constantly on the alert to help locate and report any defects or hazards in connection with Sheriff's Office property. Every employee shall report immediately to the supervisor unsafe conditions found on such premises which involve either our service or the safety of our employees. Any equipment which appears defective or unsafe, shall be removed from service at once and not used until tested, repaired or replaced.

**6-520.3 PERSONAL CLOTHING AND ACCESSORIES WHILE ON DUTY**

Loose or flapping clothing, including neckties, scarves and/or jewelry shall not be worn in the proximity of machinery, motors, engines, etc.

Employees who work with or around electrical circuits which are energized, or moving machinery shall not wear jewelry (i.e. wrist watches, bands, chains, rings, etc.).

Employees shall wear suitable shoes; and, in some assignments, safety shoes are required.

It is the policy of the Charles County Sheriff's Office to provide approved protective equipment. It is the responsibility of both supervisors and employees to see that this equipment receives proper care, is kept available, tested periodically and used when required.

All protective equipment procured and/or used shall fully comply with MOSHA / OSHA standards.

**6-520.3 PROTECTIVE CLOTHING**

Individual employees are responsible for wearing clothing that will adequately meet the safety requirements for the general type of work and conditions assigned. Appropriate clothing is required at all times to afford protection from overexposure to toxic materials, weather, and other potentially hazardous situations.

Wear a life jacket when working over or near water where safety rails are not provided and the danger of drowning exists.

Employees shall wear clothing suitable to weather conditions and the work being done. Long shirt sleeves shall be worn rolled down and buttoned at the cuff when working on or near equipment.

**6-520.4 HEAD PROTECTION**

Head protective equipment (hard hats) must be worn in areas where there is a possible danger of head injuries from the impact of falling objects.

Only approved and issued hard hats shall be worn in accordance with MOSHA / OSHA standards, which states that hard hats must be replaced within two (2) years of manufacture date stamped on bill of hat.

Before each use, the wearer shall inspect the hard hat / helmet / headgear for cracks or punctures which can reduce the degree of protection provided by the equipment. Protective headgear shall be immediately removed from service and disposed of if found defective. Protective headgear shall be clearly marked or stamped with the





## Administrative and Operational Manual

September 12, 2022

manufacturer's name.

The wearer shall inspect the suspension system for evidence of material cracking, tearing, fraying, or other signs of deterioration, and replace the suspension system immediately if any of these signs are observed. Suspension systems shall be adjusted so that there is 1 to 1 1/4 inches between the top of the wearer's head and the helmet. Other hats / caps shall not be worn under hard hats. The wearer shall wash a soiled helmet in a cleaner recommended by the manufacturer or in warm, soapy water.

### 6-520.5 FOOT PROTECTION

Safety shoes have reinforced toes with a cap. The type of protection needed will determine whether the reinforced toes is made of steel, reinforced plastics, or hard rubber. The safety shoe can insulate the wearer from heat and cold, be waterproof or chemical resistant, or provide puncture and instep protection.

Rubber soled shoes or boots do not always provide adequate protection when working on electrical equipment in wet conditions. The equipment must be de-energized.

### 6-520.6 EYE PROTECTION

Goggles, face shields or safety glasses are required when there is a potential danger from flying particles, flying objects, heavy dust conditions, extreme glare, or the presence of gases, fumes and splashing of hazardous liquids. Eye and face protection used by Sheriff's Office employees shall:

- Provide adequate protection against the particular hazards for which they are designed;
- Be comfortable, fit properly, and not interfere with the movements of the wearer;
- Be durable;
- Be cleaned and disinfected easily;
- Be clearly marked to identify the manufacturer.

Safety glasses / goggles provide adequate protection from hazards such as sparks, dusts, chemical splashes, and flying objects. Glasses / goggles shall resist impact and have side shields for additional protection. They can be worn over corrective lenses or spectacles as long as they do not disturb the way the spectacles fit.

The face shield protects against chemical or molten metal splashes, heat radiation, light impact and other hazards. A face shield shall be worn during operations when the entire face needs protection. If the shield becomes warped or scratched to the point that it impairs vision, it must be replaced. For increased protection from chemical splashes, goggles shall be worn under a face shield.

It is important that goggles and other eye protective safety equipment fit properly and be kept clean. Cracked or broken lenses should be replaced promptly.

### 6-520.7 RESPIRATORY PROTECTION

Respiratory equipment protects employees from toxic and abnormal atmospheric conditions by giving them clean air to breathe. Respirators shall be worn where hazardous fumes, vapors, and gases are evident or suspected, or when oxygen may be insufficient. The proper selection of a respiratory device depends on the type of substance encountered or being used and the current condition of the air.

The SCBA (self-contained breathing apparatus) allows the user to carry a portable air supply, usually in a compressed air cylinder, on his back and provides 30 - 60 minutes of protection. This type of respirator is used where the atmosphere is immediately dangerous to life or health. The SCBA provides the highest level of protection when protection is needed for a short time.



## Administrative and Operational Manual

September 12, 2022

Self-contained breathing apparatus should be provided and their use required when such equipment is necessary to protect the health of the employees from poisonous and suffocating gases. Supervisors must ensure that the respirator provided is suitable for the purpose intended. Employees required to wear respiratory protection must be fitted properly and must have passed the required medical evaluation.

Air purifying respirators protect the wearer from organic vapors and particulates. They filter or purify the air that the wearer breathes. This type of device does not provide breathing air and shall not be used in an oxygen-deficient atmosphere. There are two types of filters and cartridges. Mechanical filters protect against particulates such as dusts, mists and metal fumes by physically trapping the contaminant in the filter material. Chemical cartridges are filled with a highly absorbent activated carbon. Gases and vapors passing through chemical cartridges are attracted and held to the surface of the carbon.

NEVER WEAR CONTACT LENSES WITH A FULL FACE RESPIRATOR.

Dust masks shall be worn for protection from such airborne particles as dust. For extreme cases where employees are exposed to large amounts of dust, dirt, paint spray or chemicals, a cartridge respirator shall be used with the proper cartridge.

Respirators shall be stored in an area accessible to employees that is clean and sanitary to protect the respirators from heat, sunlight, extreme cold, excessive moisture, and damaging chemicals.

## 6-520.8 HAND PROTECTION

Employees shall wear approved work gloves on jobs where gloves will help prevent hand injuries. Appropriate hand protection shall be worn when dealing with hazardous or infectious conditions or substances.

## 6-520.9 HEARING PROTECTION

Exposure to excessive noise levels can result in hearing loss or damage. The loudness and the duration of sound determine whether the noise is harmful. Working daily in an area where there is steady noise greater than 90 decibels (dB) is considered hazardous, and hearing protection must be worn.

Earplugs or earmuffs must be worn by all employees who work at the maximum allowable exposure time and at the maximum sound level.

Earplugs, if properly fitted, inserted, and used, may reduce the noise reaching the ear by 25 - 30 dB in higher, more harmful frequencies. Earplugs have several advantages. They are small, comfortable when worn for a long time, and suppress noise equally at all frequencies. Earplugs made of substances other than rubber or plastic shall not be used because they tend to lose their effectiveness during the workday.

Earmuffs surround the entire external ear with a shell to provide a barrier to the sound. The effectiveness varies with the size, shape, seal material, shell mass, and the suspension of the muff. When properly fitted, earmuffs can lower noise by an additional 10 - 15 dB more than the earplugs, making them effective against sound levels of 130 - 135 dB. Earmuffs are easy to use and may be used by more than one person if the earmuffs are properly cleaned after each use.

Protection against the effects of noise exposure should be provided when the sound levels exceed those which are deemed safe by OSH standards. A detailed explanation and the specific regulations can be found by referring to the Code of Federal Regulations (29 CFR Ch. XVII - Section 1910.95). The Safety Officer shall be consulted when any issue regarding hearing conservation is in question.



## Administrative and Operational Manual

September 12, 2022

**6-520.10 WORKING AROUND MACHINES**

Machinery can be inherently dangerous due to multiple moving parts. Employees required to operate any type of machinery will follow the below listed guidelines:

- Protect long hair by a hat, cap, net, etc.;
- Use rubber or other nonskid material on the floor around machines;
- Be familiar with your machine and its safety precautions before you try to operate it;
- Operate all machinery according to instructions;
- Make sure all guards are in place before starting the machine;
- Never reach through, over, around, or under a machine in motion.
- When stopping a machine, never attempt to brake it with your hands or any makeshift braking device;
- Turn off all defective machines at once, and report them to your supervisor. Do not try to operate them;
- Do not try to repair any machine unless you are qualified and authorized to do so;
- Never try to repair any machine unless it is turned off and either locked or disconnected from its power source; and
- Use only designated safety solvent to clean machine parts.

**6-520.11 LADDERS**

- Do not use anything but OSHA approved ladders for climbing;
- Set up ladders so that the distance from the feet to the wall is approximately 1/4 the height of the ladders;
- Ladders shall extend at least three feet beyond the object they are resting upon;
- Do not work above the third rung from the top of a straight ladder nor the second step from the top of a step ladder;
- Do not try to work at more than an arm's length from each side of the ladder. Relocate the ladder;
- In climbing up or down ladders, always face the ladder and grasp the rails or the rungs firmly;
- Do not place ladders in blind corners or in front of unlocked and unguarded closed doors;
- Do not use metal ladders near electric wires or equipment;
- Ladders must be inspected regularly for defects (broken or bent steps, rungs, or rails). If a ladder is dropped, it must be inspected at once, and if defective, taken out of service, and either repaired at once or destroyed, as the supervisor decides;
- Do not paint wooden ladders. Paint may hide defects;
- Only one employee shall work on a ladder at one time.

**6-525 LIFTING AND CARRYING TECHNIQUES**

The lifting and carrying of equipment, boxes or other sizable loads can cause significant injury if an employee fails to take safety precautions.

- Size up the load. Do not attempt to lift it alone if there is any doubt in one's ability;

**Administrative and Operational Manual****September 12, 2022**

- Make sure footing is secure. Get a proper balance. This means feet fairly close together (10 to 12 inches apart);
- Place feet close to base of the object to be lifted. Placement of feet is important because this prevents the back muscles from taking all the load;
- Bend the knees and squat. Do not stoop. Keep the back straight and as nearly vertical as possible. If necessary, spread the knees or lower one knee to get closer to the object;
- Push with legs, thereby using the strongest set of muscles and keeping the load close to the body;
- Lift objects to the carrying position. If it is necessary to change direction when in the upright position, be careful not to twist the body. Turn the body with changes of foot positions;
- When putting the load down to the floor surface from a waist-high position, bend the knees and with a straight back, lower the load with the arm and leg muscles;
- To place an object in a tight space, it is safer to slide it into place with hands in the clear, than to try to lift it and set it down;
- If a load is deposited on a bench, table, truck, etc., place it on the edge so the landing point takes part of the load, and then push forward with arms, or if necessary with part of the body in a forward motion.

**6-525.1 PULLING AND PRYING**

When pulling or prying objects be sure to be properly positioned, balanced and in the clear so as not to be caught between or thrown off balance if the pry slips or the piece suddenly gives. Wear proper protective equipment, i.e., gloves, eye protection (if needed).

**6-530 COLD WEATHER AND HEAT MANAGEMENT****6-530.1 COLD WEATHER GUIDELINES**

Cold weather safety should be of concern to all who work outdoors during the winter months. According to the National Safety Council, knowing how to recognize, prevent and field-treat frostbite and hypothermia might protect the well-being of employees over winter months.

Frostbite is the actual freezing of a part of the body due to exposure to temperatures below freezing. It is common on the face, hands and feet, and the onset may be signaled by a tingling sensation in the affected area. The first external sign of frostbite is the appearance of white waxy spots on the effected body part. Early detection of these spots can minimize tissue damage. The hands and feet present a more difficult problem, but, if hands and feet have been feeling the effects of the cold and then suddenly stop hurting, frostbite has probably set in.

Frostbite can be prevented by implementing some easy safety measures. The National Safety Council suggests protecting the face and head with a wool stocking cap pulled down to cover ears and the nape of the neck. Since wool is not windproof, additional head and face protection, such as a face mask, may be necessary on extremely cold, windy days.

Do not let the hands get wet with gasoline, kerosene, alcohol or any other fluid which freezes below 30-degrees F. These fluids will cause instant frostbite in sub-zero temperatures. Also, remember to wear boots that are roomy enough to permit movement of toes with no feeling of tightness.



## Administrative and Operational Manual

September 12, 2022

If light frostbite is suspected, there are immediate measures to be taken to care for it:

- Cover the face with warm hands until the pain returns;
- Fingers are best heated by placing them under the opposite armpit next to bare skin;
- Place bare feet under the clothing of a friend, if one is with you. Do not massage your feet, nor expose them to open fires, heat from vehicle mufflers, cold water soaks, immersion in petroleum liquids, or rubbing with snow, etc.
- For treatment of deep frostbite, try to get a medical facility as soon as possible instead of treating it in the field. Thawing of deep frostbite in the field increases pain, invites infection and, possibly, the onset of gangrene;

Hypothermia is a subtle, insidious killer: the loss of heat from the body's vital inner core. The condition results when the loss of body heat is greater than body heat production. The National Safety Council points out that people can lose body heat in many ways, including:

- Sitting on snow or on cold vehicles or becoming wet from rain or sweat;
- Uncovered areas of the skin surface, especially the head and neck, can suffer heat loss;
- A certain amount of heat is lost through the evaporation of sweat from the skin;
- Hypothermia can be prevented by wearing protective clothing. Eat three well-balanced meals a day, drink plenty of fluids, and work at a slow but steady pace;
- Symptoms of hypothermia may include mild depression, lack of enthusiasm for simple tasks, inability to concentrate, fatigue, difficulty in walking, violent shivering, staggering and falling;
- To treat hypothermia in the field, try to reduce heat loss by replacing wet clothing, drinking warm, non-alcoholic beverages, and seeking shelter from wind, wetness and cold.

Working safely during winter is possible if precautions are taken against the cold wind and snow. Being familiar with terminology used by the Weather Service will help to know what to expect when weather warnings are issued. The following terms are used frequently in winter weather releases:

**Freezing Rain:** occurs when temperatures are below 32° F and rain freezes on impact. This causes an ice coating on all exposed surfaces. If the coating is heavy, falling trees or wires can be additional hazards.

**Freezing Rain or Drizzle:** called an ice storm when a substantial glaze layer accumulates. In some parts of the country, ice storms are called "silver thaws" or "silver frosts."

**Sleet:** frozen rain drops (ice pellets) which bounce on surface impact. Sleet does not stick to objects, but sufficient accumulations can cause dangerous driving conditions.

**Travelers' Advisory:** falling snow and/or drifting snow, strong winds, freezing rain or drizzle will make driving hazardous.

**Heavy Snow Warnings:** issued when 4 or more inches are expected during a 12-hour period, or when 6 inches or more are expected during a 24-hour period.

**Blowing and Drifting Snow:** results from strong winds, blowing falling snow, or loose snow on the ground and



## Administrative and Operational Manual

September 12, 2022

can produce sizeable drifts.

**Blizzard:** warnings are issued when wind speeds of 35 miles per hour or more are expected with blowing or drifting snow.

**Snow Squalls:** brief, intense snowfalls accompanied by gusty surface winds.

**Stockman Advisories:** issued with combinations of cold, wet and windy weather, specifically, cold rain and/or snow with temperatures of 45° F or colder and winds of 25 miles per hour or higher. If the temperatures are in the mid-30s or lower, the wind speed criteria are lowered to 15 miles per hour.

**Wind Chill Factor:** the combined effect of wind and cold. A very strong wind combined with a temperature below freezing can have the same chilling effect as a temperature nearly 50 degrees lower with no wind. For example, if the outside temperature is 20° F and the air is calm, the wind chill temperature is the same, 20° F. But with the same temperature and a 30 mph wind, the effect on your body is the same as if the temperature were 18° F. A strong wind can make any winter temperature "chilling." Anyone who is outdoors exposed to low temperature and strong winds will be more easily exhausted and more subject to frostbite or even death.

## 6-530.2 HEAT STRESS MANAGEMENT

Supervisors of employees should be responsible for initiating a Heat Stress Management Program for their respective employees where work is performed in temperatures above eighty (80) degrees Fahrenheit or where impermeable protective clothing (e.g. Tyvek coveralls) is worn in temperatures above fifty (50) degrees Fahrenheit.

The Heat Stress Management Program should include the following:

- Training for those employees affected which, at a minimum, will include a review of the symptoms, methods of prevention, and appropriate first aid for the four types of heat stress;
- Exposed employees will have a sufficient quantity of potable water available for drinking. Employees who do not have a fixed drinking water source in near proximity to their work place must have potable drinking water containers;
- An employee may require replacement of as much as two gallons of water per eight-hour shift;
- Sport liquids, such as Gatorade, or other equivalent replacement liquids, can also be made available as a supplement to water for heat exposed employees;
- The supervisor must provide for new employees or not previously exposed employees to acclimate gradually to working in "hot environments";
- Most methods of acclimatization require that employees be exposed gradually to greater periods of time in the heat;
- Unacclimated employees should not be expected to complete their assigned duties in the same period or at the same rate as those who have adjusted to the heat. Allowance for this reduction will increase with both temperature and humidity;
- One alternative to the reduced capacity / rate of unacclimated workers is to increase the number of people assigned to the job until the employees have acclimated or heat stress is reduced;



**Administrative and Operational Manual**

**September 12, 2022**

- The supervisor must develop a method of scheduling sufficient breaks between work periods;
- Acclimated employees in hot environments will require periodic rest periods to prevent heat stress. Scheduled breaks will ensure that employees do not lose track of cooling periods and are able to take time to replace lost water;
- Generally, acclimated employees working at temperatures above eighty (80) degrees Fahrenheit, or fifty (50) degrees for employees wearing impermeable protective clothing. They will be able to continue their normal work schedule, taking breaks as experience dictates;
- When temperatures exceed ninety (90) degrees Fahrenheit, employees' awareness of the risks of heat stress should be increased. Daily reminders should be implemented to ensure that employees are taking appropriate precautions.

## **6-540 SAFETY PRECAUTIONS FOR DOWN ELECTRIC LINES**

### **6-540.1 PROCEDURES**

All sworn officers shall abide by the following safety precautions concerning “down electric lines.”

- Never touch or go near down electric lines or allow anyone except the power company employees to touch or go near the lines.
- As soon as you are aware that you have down lines, call for Southern Maryland Electric, and, if practical, wait until they arrive and tell you when it is safe before approaching the scene.
- Do not try to move down lines - things that you may think are not conductors of electricity may become conductors; for example, wood, trees, sticks, police night sticks, etc. Strings and ropes also may become conductors.
- The surface that you are standing on may be a conductor - dirt, asphalt, concrete, etc., so at all times try to stay at least twenty (20) feet from a down line, further if possible. If at any time an officer feels that he has come in contact with an energized surface, keep both feet on the ground and shuffle away from the down wire.
- Although some transmission lines for electricity may appear to have insulation around the copper conductor, it is not actually insulation. It is just weather proofing and will also conduct electricity.
- If officers arrive on the scene of a motor vehicle crash and electric lines are laying on or around the crashed vehicle, have the occupants stay in the vehicle, or, if possible, have them drive their car away from the down lines. If officers drive up to the scene and observe down lines near their patrol vehicle, back away from the down lines before exiting the vehicle, or you may become a victim.
- If officers arrive on the scene of down lines and do not know if they are electric lines, phone lines or cable TV lines, treat them as electric lines and call for Southern Maryland Electric.

## **6-600 AGENCY VEHICLE CRASHES**

The procedures and reports specified hereafter shall apply to any crash involving Agency vehicles. Agency vehicles, in this regard, include vehicles that are owned, leased, rented, or acquired in any manner by the Agency and which are used by Agency personnel.



Administrative and Operational Manual

September 12, 2022

An Agency vehicle crash occurs when:

- An Agency vehicle collides with another motor vehicle, object, natural force or person, or catches fire on a public roadway, and damage, injury, or death occurs; and
- The Agency vehicle crash meets the criteria for documentation on the Maryland Automated Crash Reporting System (ACRS).

An Agency vehicle crash does not include:

- an Agency vehicle, not in transport, struck by an object such as a tree limb, shopping cart, or object moved by forces of nature (note: an Agency vehicle is in transport when occupied and running, regardless of physical vehicle location);
- damage to an Agency vehicle during a single vehicle incident limited to the vehicle tire only;
- an incident which damages an Agency vehicle, or where damage is done by an Agency vehicle, but does not meet the requirement for reporting in the Maryland Automated Crash Reporting System (ACRS).

A serious physical injury for the purpose of this section is defined as a physical injury which creates a substantial risk of death, or which causes death or serious and protracted disfigurement, protracted impairment of health or protracted loss or impairment of the function of any bodily organ.

### 6-600.1 NOTIFICATION OF INVOLVEMENT

Agency personnel involved in an Agency vehicle crash shall:

- immediately notify Communications via police radio, or cellular telephone if the police radio is inoperable or inaccessible, of the crash and type of crash (PD, PI, Hit and Run, or Fatality);
- request the Communications Section notify either the Traffic Operations Unit and/or an on-duty supervisor to respond;
- if needed, request Emergency Medical assistance for all parties involved;
- in cases occurring within Charles County, Maryland, request notification be made to the CCSO shift commander;
- in cases occurring outside of Charles County, Maryland, contact the nearest police agency having jurisdiction (in these cases, the driver shall also notify Communications as soon as possible).

The Communications Section will make the following notifications through the CAD Alert Notification System:

- the Fleet Manager;
- the Commander, Property Management Section;
- the Commander, Special Services Division;
- the Commander, Field Operations Section;
- the Executive Command Staff.

### 6-600.2 GENERAL RESPONSIBILITIES

If the Agency vehicle crash occurred within Charles County, Maryland:

- during regular on-duty hours, Traffic Operations officers will respond and investigate all Agency vehicle crashes. When off-duty, they will respond, on an on-call basis, to all crashes involving injury to any Agency





## Administrative and Operational Manual

September 12, 2022

personnel or any departmental crash involving injury to a civilian. The Traffic Operations Unit will also investigate all Agency crashes that involve a serious life-threatening injury or a fatality;

- if the crash involves death, personal injury, or there are unusual circumstances, the shift commander or Commander, Field Operations Section shall, if practical, assume command of the scene and meet with the original incident commander or supervisor directing the investigation;
- the on-duty commander shall notify the involved personnel's commander or director as soon as practical;
- all crash reports will be reviewed and approved by the Traffic Operations Unit Supervisor or his designee;
- a completed Report of Agency Vehicle Damage form (CCSO Form #843) will be emailed to the email group [departmentals@ccso.us](mailto:departmentals@ccso.us) for appropriate disposition;
- in cases involving serious life threatening injury or fatality, the Traffic Operations Supervisor will notify the Commander, Field Operations Section, the Agency General Counsel, the Media Relations Office and the Charles County State's Attorney.

If the crash occurred outside of Charles County, Maryland:

- if the crash occurred within a reasonable distance of Charles County, Maryland, the shift commander or his representative may respond to the scene to gather information and provide liaison between the investigating police agency and the CCSO;
- the district / shift commander shall obtain, or have the involved personnel obtain, a copy of the police investigation and report;
- The Shift Commander, or investigating supervisor, shall document the crash on a Report of Agency Vehicle Damage form (CCSO Form #843) and submit the form via email to the email group [departmentals@ccso.us](mailto:departmentals@ccso.us) prior to the end of the duty shift during which the crash occurred.

### 6-600.3 CONDUCT OF INVESTIGATION

The crash investigator will conduct a thorough and complete investigation of all crashes involving Agency vehicles. The investigator shall review all recorded video footage if available, interview witnesses, examine physical evidence and document the crash appropriately in the Maryland Automated Crash Reporting System (ACRS). The Agency crash investigator shall determine contributing crash factors, investigate for signs of impairment in all involved parties and take appropriate action, determine traffic and/or criminal charges, and provide an opinion as to the preventability of the crash on the part of the Agency vehicle operator.

The results of the crash investigation will be provided in written format to them through use of the appropriate forms including the Report of Agency Vehicle Damage form (Form #843), Crash Investigation Report (Form #291), Maryland Automated Crash Reporting System (ACRS), and/or other required documents.

The crash investigator, or his immediate supervisor, shall provide notification to the CCSO Command Staff and Media Relations Specialist by completing a Commander's Information Report immediately following the initial investigative phase.

Except for crashes involving serious life threatening injury, fatality, or possible driving while under the influence or criminal charges incurred by an Agency driver, crash investigations are considered administrative in nature.



## Administrative and Operational Manual

September 12, 2022

**6-601 DOCUMENTING DAMAGE TO AGENCY VEHICLES**

Damage to an Agency vehicle which does not meet the criteria referenced in AOM 6-600 as an Agency Vehicle Crash will be documented on the Report of Agency Vehicle Damage (Form #843) only. A separate Report of Agency Vehicle Damage (Form #843) must be completed for each damaged Agency vehicle even if multiple Agency vehicles were damaged during the same event. This form will be completed for any vehicle damaged during an event or in any instance where an Agency vehicle causes damage to another vehicle, structure, or other object. The completed form will be emailed to the email group departmentals@ccso.us prior to the end of the investigator's tour of duty.

Damage to an Agency vehicle which meets the criteria as an Agency Vehicle Crash as defined in AOM 6-600 shall be documented in the Maryland Automated Crash Reporting System (ACRS). All vehicles and property involved in an Agency Vehicle Crash will be recorded within the single ACRS Report for a single incident. A separate Report of Agency Vehicle Damage form (Form #843) will be completed for each Agency vehicle damaged during the Agency Vehicle Crash. The Agency vehicle information will be included on each Report of Agency Vehicle Damage. However, information for non-Agency vehicles or property documented in the ACRS Report will not be entered onto the Form #843. The completed form will be emailed to the email group departmentals@ccso.us prior to the end of the investigator's tour of duty.

**6-602 DISPOSITION OF INOPERABLE AGENCY VEHICLES**

When an Agency vehicle is rendered inoperable because of a collision, the CCSO investigator will consult with a representative of Property Management for towing instructions. The vehicle will be towed to a location most advantageous for appraisal, examination, and protection of the vehicle and its contents.

After any investigative examination, the Commander, Property Management will assume the control of the vehicle until repair or disposition is made of the vehicle.

In the event an Agency vehicle was involved in a collision which rendered it inoperable outside of Charles County and the distance is so great an Agency representative could not respond, a district / shift commander will contact the investigating agency and arrange for the secured storage of the vehicle. Property Management will then arrange for the return of the vehicle to Charles County.

**6-605 VEHICLE EQUIPMENT**

Responsibility for the CCSO property and equipment carried within CCSO vehicles is the responsibility of the Agency driver of the vehicle. If the driver is unable to fulfill this responsibility because of injuries sustained in the collision, the CCSO supervisor at the scene is responsible for making security arrangements. Lacking a CCSO supervisor on the scene, the CCSO investigator shall assume responsibility for the security and disposition of property contained in the vehicle at the time of the collision. If the collision occurred outside of Charles County, and the involved employee is unable to secure the CCSO property, the district / shift commander shall arrange to secure the property.

**6-607 AGENCY VEHICLE REPAIRS**

When an Agency vehicle has been damaged and the vehicle is:

- in the custody of the Commander, Property Management, the Fleet Manager shall secure estimates of the cost of repairs and cause the vehicle to be repaired or replaced in a timely fashion; or
- in the custody of other CCSO personnel, the person in custody of the vehicle shall contact the Commander, Property Management within 48 hours for direction to obtain two estimates of the cost of repairs to be forwarded to the Commander, Property Management, who shall authorize and direct repair or replacement



## Administrative and Operational Manual

September 12, 2022

in a timely fashion.

Only the Commander, Property Management shall authorize and secure the repair of damaged CCSO vehicles. All inquiries concerning such repairs shall be directed to the Commander, Property Management. The Fleet Manager shall be responsible for tracking the performance of various vendors who repair vehicles for the CCSO.

The Fleet Manager shall provide the Commander, Property Management with all appropriate information, such as the history and performance evaluations of vendors, so as to allow the Commander, Property Management to direct repairs to the most qualified and cost-effective vendors. The Commander, Property Management shall also track the economy of using particular vendors and shall direct repairs in such a manner as to provide repairs at the most cost effective vendors consistent with excellence of the repair work.

## 6-608 OPR INVESTIGATION

In case of any life threatening injury or fatal Agency vehicle collision involving a CCSO driver, the Commander, OPR shall cause a separate administrative investigation to be completed.

### 6-608.1 DETERMINATION OF PREVENTABILITY

**Preventable Collision** - As used in this section, a preventable collision is a collision which occurred because the driver of any vehicle failed to take any action which would have prevented the damage and injury, or the driver of any vehicle took a course of action which was the cause of any damage or injury.

**Non-preventable Collision** - As used in this section, it means any occurrence involving a collision in which everything that could have been reasonably done to prevent it was done and the collision still occurred.

**Excusable** - As used in this section, it means that which can be excused, is pardonable, or possibly justifiable. Also, it could mean a finding that an employee involved in an unintentional collision may be partially or wholly at fault; however, the collision may be excusable when considering exceptional circumstances surrounding the incident.

### 6-608.2 PREVENTABLE COLLISION FACTORS

It is expected, because driving a vehicle is such a significant part of many of the Agency's employees' jobs, they will become safe driving enthusiasts. Employees should always drive defensively, attempting to anticipate wrong moves on the part of other drivers and thereby avoiding collisions which might otherwise result.

Employees should always drive within the confines of their personal capabilities and the limitations imposed by each vehicle's design and handling characteristics. In order to define a defensive attitude and the nature of preventable collisions, employees shall consider the following situations developed by the State Fleet Safety Committee in conjunction with the National Safety Council:

- **Intersections** - It is the responsibility of Agency vehicle drivers to approach, enter and cross intersections prepared to avoid collisions which might occur through the actions of other drivers. Complex traffic movement, blind intersections, or failure of the "other driver" to conform to laws or traffic control devices will not automatically discharge a collision as "not preventable." Intersection collisions are sometimes preventable even when the favored driver has not violated traffic regulations. His failure to take precautionary measures prior to entering the intersection is a factor to be studied in making a decision. When a driver crosses an intersection and the obvious actions of the "other driver" indicate possible involvement, either by reason of his excess speed, crossing his lane and turning, or coming from behind a blind spot, the decision, based on the favored driver allowing such entrapment, should be "preventable."
- **Vehicle Ahead** - Regardless of the abrupt or unexpected stop of the vehicle ahead, a driver can prevent



## Administrative and Operational Manual

September 12, 2022

front-end collisions by maintaining a safe following distance at all times. A safe following distance is one which allows the driver sufficient time, distance, and vision requirements to avoid a collision and to reduce traffic conflict. This includes being prepared for possible obstructions on the highway, either in plain view or hidden by the crest of a hill or the curve of a roadway. Over driving headlights at night is a common cause of front-end collisions. Night speed should not be greater than that which will permit the vehicle to come to a stop within the forward distance illuminated by the vehicle's headlights.

- **Vehicle Behind** - Investigation often discloses drivers risk being struck from behind by failing to maintain a margin of safety in their own following distance. Rear-end collisions preceded by a roll-back, an abrupt stop at a grade crossing when a traffic signal changes or when the driver fails to signal a turn at an intersection should be considered preventable. Failure to signal intentions or to slow down gradually should be considered preventable.
- **Passing** - Failure to pass safely may indicate faulty judgment and the possible failure to consider one or more of the important factors a driver must observe before attempting the maneuver. Unusual actions of the driver being passed or of oncoming traffic might appear to exonerate a driver involved in a passing collision; however, the entire passing maneuver is voluntary and is the passing driver's responsibility.
- **Being Passed** - Sideswipes and cut-offs involving a driver while he is being passed are preventable when he fails to yield to the passing vehicle by slowing down, moving to the right where possible, or maintaining speed, whichever action is appropriate.
- **Oncoming** - It is extremely important to check the action of the Agency driver when that driver is involved in a head-on or sideswipe collision with a vehicle approaching from the opposite direction. The exact location of a vehicle prior to and at the point of impact must be carefully verified. Even though an opposing vehicle enters the Agency driver's traffic lane, it may be possible for the Agency driver to avoid the collision. For example, if the opposing vehicle was in a passing maneuver and the Agency driver failed to slow down, stop or move to the right to allow the vehicle to re-enter his own lane, he has failed to take action to prevent the occurrence. Failing to signal the opposing driver in an appropriate manner should also be taken into account.
- **Fixed Objects** - Collisions with fixed objects are preventable. They usually involve failure to check or properly judge clearances. In some cases they involve a failure to properly divide driver attention between an Agency specific task and the driving task; i.e., running into a pole while checking for broken windows in a T/A at night. An Agency driver must be constantly vigilant for conditions which may lead to collisions with fixed objects and make the proper adjustments in vehicle speed and position to avoid such collisions.
- **Pedestrians** - Traffic regulations and court decisions generally favor the pedestrian hit by a moving vehicle. Where pedestrian traffic can be anticipated, whether signs are posted or speed limits reduced, speed too fast for conditions may be a factor in the collision. School zones, shopping areas, residential streets and other areas with special pedestrian traffic concerns must be traveled at reduced speeds compatible with that particular environment. Bicycle, skate and skateboard traffic requires special vigilance due to the youth and inexperience of those operators. Agency drivers who fail to reduce speed in the face of this kind of traffic have failed to take the necessary precautions to prevent a collision. Driving at the speed limit is not in itself a defense for a collision in these circumstances.
- **Passenger Collisions** - Agency drivers are responsible for passenger use of restraint devices. Drivers must be alert to traffic conditions which pose hazards to embarking and disembarking passengers and take care to alert passengers to such hazards.
- **Non-Collision** - Many collisions, such as overturning or running off the road, may result from emergency action by the driver to preclude being involved in a collision. Examination of driving actions prior to the incident may reveal speed too fast for conditions or other inappropriate action in the face of developing



## Administrative and Operational Manual

September 12, 2022

driving conditions ahead. The Agency driver's actions prior to involvement will be examined for possible errors in judgment and failure to maintain a defensive driving attitude.

- **Backing** - Many Agency collisions result from backing vehicles into unobserved objects. Therefore, drivers will, in every instance possible, park vehicles by backing them into a parking area. In those instances when it is necessary to back from a parking space, the driver will, before moving the vehicle, visually inspect the area to the rear of the vehicle to eliminate the possibility of striking unseen objects. When using another person to direct the backing movement of a vehicle, the driver still retains responsibility for the movement. It is incumbent on the driver to be certain the path for backing is free from obstacles.
- **Division of Attention** - The police tasks which are necessarily accomplished during the operation of a vehicle require a practiced application of dividing the attention of the Agency driver between the vehicle's operation and the police tasks. Examples of some, but not necessarily all, of these tasks are: the use of the police radio and other communications devices; the observation of surrounding activities for signs of danger or criminal actions; the evaluation of the roadway for need of repair or removal of debris; observation of people surrounding the path of travel of the vehicle for evaluation as wanted or otherwise person of interest; and so forth. This task of division of attention can cause an operator to fixate upon a single task to the detriment of others. The operator must keep the driving task as paramount and limit other tasks to a degree which does not compromise safe operation of the vehicle. When necessary for safety, the vehicle shall be stopped out of harm's way when a greater concentration is needed for other police tasks. Agency operators must continually force themselves to avoid fixation on a particular circumstance, even in times of stress.

It is not necessary to describe in detail the many ways a driver might prevent a collision without being primarily or legally responsible. Agency drivers are expected to be defensive in their driving. A defensive driver is one who commits no driving errors himself and makes all possible allowances for the lack of skill and improper driving practices of the other drivers. A defensive driver adjusts his own driving to compensate for unusual weather, road and traffic conditions, and is not tricked into a collision by the unsafe actions of pedestrians and other drivers. By being alert to collision-inducing situations, he recognizes the need for preventive action in advance and takes the necessary precautions to prevent the collision. As a defensive driver, he knows when it is necessary to slow down, stop, or yield his right-of-way to avoid involvement.

## 6-610 AGENCY COLLISION COMMITTEE

In order to evaluate each incident of a collision involving an Agency vehicle uniformly and effectively, an Agency Collision Committee has been established. The Committee shall be comprised of the commander / director of each of the Agency's divisions. Should a commander / director need to delegate this duty for a particular meeting of the Committee; his choice will be approved by the Assistant Sheriff of Operations. The Committee Chairman shall be the Commander, Special Services.

In reviewing each incident of a collision involving an Agency vehicle, the Committee shall use the Collision Committee Guidelines, Work Sheet, and Committee Report as established by the Committee. The Guidelines, Work Sheet and Report will be published on the Agency Intranet for ready use by the Committee and for information and review by all employees.

The Committee should meet weekly to review all Agency collisions whose reports have become available within the previous 7-day period. The Commander, Special Services Division may cancel or reschedule a meeting if there were no new collision reports for the previous 7-day period or if additional time is needed to gather the required information and complete a Work Sheet.

The intention of the Guidelines is to provide for equitable actions to be taken and recorded from one case to another. In order for the process to be effective, the Guidelines should direct the proceedings of the Committee. However, the Guidelines are not intended to strictly limit the courses of any action which might be taken by the Collision

**Administrative and Operational Manual****September 12, 2022**

Committee in fulfilling its responsibilities. These responsibilities include, but are not limited to:

- increasing vehicle operation safety awareness within the Agency;
- making safety recommendations to the Sheriff;
- identifying collision reduction strategies, techniques and training;
- defining methods of collision reduction for specific employee vehicle operators;
- recommending remedial vehicle operation training;
- reviewing statistical collision cause indicators for groups and individuals; and
- providing for the uniformity of actions through the use of these Guidelines and discussion and consensus of the Committee.

As part of the Committee's commitment to making the best determinations possible in each incident and for making recommendations on training and reducing Agency vehicle collisions, the Committee will use all available resources to evaluate data on the operation of vehicles by employees of the CCSO. Data may be gathered from, but is not limited to:

- Human Resources
- Property Management
- Records Management
- (Budgeting / Accounting)
- Local Government Insurance Trust (LEGIT)
- Training Division

## **6-610.1 COMMITTEE PROCEDURES**

Before each meeting, the Committee Chairman will prepare a Work Sheet for each incident. A copy of the completed Work Sheet will be provided to the involved employee's division commander at least one work day in advance of any Committee meeting. At each meeting the Chairman will present the results and any other information or materials that may be relevant. The members of the Committee present will deliberate and reach an agreement on actions for each case. It is expected that any preventable collision will result in some corrective and/or punitive actions from the Committee.

The Committee shall have the prerogative of directing the investigating officer to appear before it for the purpose of clarifying or obtaining information. Any employee who is involved in an Agency vehicle collision may contact the Committee Chairman to request to appear before the Committee to explain the circumstances of an incident. The request to appear will be made using Agency email and be directed to the Committee Chairman. All email correspondence between the Chairman and employees will be copied to all persons in the chain of command. Supervision, management and command levels will allow employees, who are scheduled to work when their appearance is needed before the Committee, to attend without use of leave. Respondents who are off-duty will attend at their discretion without any compensation or leave. Investigators who are required to appear will be compensated if they are off-duty.

The Committee will make every effort to reach a conclusion for each collision within thirty (30) days from the date of the collision. Employees will be sent written notification of the Committee's decision within five (5) calendar days of the finding. Employees shall sign a copy of the Collision Committee Report and return that signed copy to the Collision Committee Chairman. If the Report finds the collision to be preventable, the involved employee may check the box on the Report to request an appointment to appear before the Committee to provide a personal statement that may be taken into consideration of the accident. A copy of the Collision Committee Work Sheet will be provided to the employee for review at least 5 calendar days prior to the appointment with the Committee.

## **6-610.2 WORK SHEET INSTRUCTIONS**

The Collision Committee Work Sheet is to be used for each Agency vehicle collision. The sheet is laid out with



## Administrative and Operational Manual

September 12, 2022

space for the involved officer's name, ID, date and an I.R. number. The next items are check boxes for Preventable or Non-preventable incidents. If Non-preventable is selected and there are no extenuating factors, such as the in-car video was not in use as required by Agency policy or the seat belt was not used by the involved officer, the Chairman will move on and complete the Collision Committee Report. If there are extenuating factors involved in a non-preventable collision, the appropriate points will be recorded and a recommendation for action will be made.

For preventable events, the Chairman will review the collision report and circle the appropriate points for each applicable section of the Work Sheet.

- a primary cause;
- if there were injuries to the employee or others;
- civilian vehicle damages;
- other property damage; and
- seat belt use.

The Chairman will also utilize other available information such as:

- Agency vehicle damage estimates;
- prior preventable collision damages information for prior 3 years or 100,000 miles;
- prior good Agency driving record; and
- information about any other mitigating factors.

The Chairman will record the plus points and minus points and reach a total point value for the incident. If the point total is equal to five (5) points or less, or if in the opinion of the Chairman there are exceptional circumstances surrounding the incident that favor the employee, the Chairman may conclude that the collision is an excusable event. All findings of the Chairman will be recorded on the Work Sheet.

### 6-610.3 DISPOSITION OF AGENCY COLLISIONS

Because of the Committee's deliberations over the Chairman's presentation, one of the following determinations will be agreed upon:

- Non-Preventable;
- Preventable; or
- Excusable.

The Committee may then deliberate about the points assessed and, if all are agreed, the Point System Guide will be used to determine what actions are to be taken. Once the points for each incident are decided, there should be no deviation from the Point System Guide. By following the Guide, actions taken will result in more equitable treatment from one case to another.

The Point System Guide provides for the following actions to be taken:

#### **First collision within 3 years or 100,000 miles:**

##### 6 or Less Points:

Conference Form.

##### 7-15 Points:

Conference Form + Remedial Training-policy review, with Supervisor/Commander.

##### 16 or More Points:



Administrative and Operational Manual

September 12, 2022

Letter of Reprimand + Remedial Training-Driving, with certified instructor + Loss of Take-Home Car Privileges for 10 days (mandatory), Fitness for Duty Exam, loss of leave, a fine, or possible loss of employment (discretionary).

**Second collision within 3 years or 100,000 miles:**

6 or Less Points:

Conference Form + Remedial Training-policy review, with Supervisor/Commander.

7-15 Points:

Letter of Reprimand + Remedial Training-Driving, with certified instructor + Loss of Take-Home Car Privileges for 15 days (mandatory), Fitness for Duty Exam, loss of leave, a fine, or possible loss of employment (discretionary).

16 or More Points:

Letter of Reprimand + Remedial Training-Driving, with certified instructor + Loss of Take-Home Car Privileges for 30 days (mandatory), Fitness for Duty Exam, loss of leave, a fine, or possible loss of employment (discretionary).

**NOTE:** If your first collision within 3 years or 100,000 miles was 8 points or less, your second collision within 3 years or 100,000 miles will be counted as the first.

**Third collision within 3 years or 100,000 miles:**

6 or Less Points:

Letter of Reprimand + Remedial Training-Driving, with certified instructor + Fitness for Duty Exam + Loss of Take-Home Car Privileges for 30 days (mandatory), loss of leave, a fine, or possible loss of employment (discretionary).

7-15 Points:

Letter of Reprimand + Remedial Training-Driving, with certified instructor + Fitness for Duty Exam + Loss of Take-Home Car Privileges for 45 days (mandatory), loss of leave, a fine, or possible loss of employment (discretionary).

16 or More Points:

Letter of Reprimand + Remedial Training-Driving, with certified instructor + Fitness for Duty Exam + Loss of Take-Home Car Privileges for 60 days + a loss of leave or a fine (mandatory), and a possible loss of employment.

**Four or more preventable collisions within 3 years or 100,000 miles:**

Letter of Reprimand + Remedial Training + Fitness for Duty Exam + Loss of Take-Home Car Privileges for six months + a loss of leave or fine (mandatory), and a possible loss of employment.

**NOTE:** Loss of employment may be recommended when an employee has a collision involving gross negligence, alcohol or drug use or has repeatedly been shown to not respond to remedial and punitive measures. Additionally, court sanctions where an employee loses their driver's license may translate to a loss of required skills and abilities to retain a position with the Agency.

The Committee's actions will be recorded on the Collision Committee Report. A copy of the Report will be provided to the employee and the employee's division commander / director within five (5) working days of the finding. The employee and the division commander / director will return a signed copy to the Committee Chairman. The





**Administrative and Operational Manual**

**September 12, 2022**

Chairman will keep a copy of the Report on file for a period of three years.

Disciplinary and remedial actions taken shall be administered at the direction of the employee's division commander / director using OPR's forms in the manner of all disciplinary actions. Division commanders / directors shall consult with the Commander, OPR upon initial receipt of the Collision Committee's findings in order to make a determination of how to proceed relative to the recommended actions.

A final determination and implementation of administrative or disciplinary action shall occur within 30 calendar days of the Collision Committee's decision, unless extenuating circumstances prevent this. In these cases, the involved division commander / director shall generate a memorandum to the Commander, OPR describing the circumstances preventing the disposition and a projection of the expected disposition date.

Any appeal or grievance of an action taken as a result of the decisions of the Collision Committee will be made as outlined elsewhere in the AOM.

### **6-611 QUARTERLY AGENCY COLLISION REPORT**

The Commander, Special Services shall generate a quarterly report for the Sheriff and the Assistant Sheriffs identifying the following information for each Agency collision. A copy of the report will be provided to the Office of General Counsel.

- the date of the collision;
- the identifying case number associated with the collision;
- the name of the operator of the Agency vehicle involved;
- the names of any Agency personnel who may be the subject of disciplinary action as a result of the collision;
- any special circumstances or considerations which may impact the investigation or disciplinary action;
- the finding of preventable or non-preventable;
- extent of damage to Agency property; and
- any other information the Commander, OPR, the Assistant Sheriffs or the Sheriff believes to be valuable reference information concerning Agency collisions.

This report shall be in the form of a list, beginning at the start of each calendar year, with each collision making up a succeeding section on the list. At the end of the list there will be a tabulation of the information contained on the list. The list will be filed at the end of the calendar year and a new list begun.

### **6-612 AGENCY COLLISION FREE DRIVING AWARDS**

The Charles County Sheriff's Office has established an Agency Collision Free Driving Award Program. This program is designed to acknowledge and reward the efforts of operators of Agency vehicles who avoid vehicle collisions.

Agency vehicle collisions represent significant costs in productive work hours, medical payments, property damage, legal fees and liability costs. By avoiding vehicle collisions, employees can put those costs to more productive uses for the Agency and the citizens of Charles County.

Employees, who are successful in this regard, will be recognized by a public announcement of their accomplishment and a certificate of achievement. Additionally, because of the significant savings to be potentially realized by the Agency, at certain levels of accomplishment, the employee will receive a Safe Driving ribbon as



Administrative and Operational Manual

September 12, 2022

recognition of the employee's accomplishment.

In order to establish an awards program of this type, there must be some way of fairly judging employee performance. Many such programs rely on years' service. Since there is a great deal of difference in the amount of exposure each employee has to collisions during a given time period, this program relies on miles driven as a more practical way of defining exposure. Awards will be made, according to the following schedule, for continuous strings of miles driven without a preventable collision:

- 50,000 miles ..... Certificate of award
- 100,000 miles ..... 2 days of Admin. Leave, Safe Driving Ribbon and Certificate
- Each Additional 50,000 miles ..... 1 Day of Admin. Leave and Certificate

These miles must be accumulated without a preventable collision. Any preventable collision restarts the counter at zero.

Employees may begin participating in the program once they have driven at least 50,000 miles without involvement in a preventable collision. It is the individual employee's responsibility to track their mileage driven and to request an award by way of a memorandum through their chain-of-command to the Fleet Manager. The Fleet Manager will verify the mileage driven without a preventable collision and will notify the employee's division commander / director of the appropriate award. The employee's division commander / director will arrange for the presentation of the award.

### 6-612.1 ARRIVE ALIVE PROJECT

The Arrive Alive Project was implemented in October of 2013 to focus attention on dangerous driving behaviors and to increase officer safety awareness. This project is organized and managed through the Traffic Operations Unit. This project entails, but is not limited to, the following elements:

- covert surveys of seat belt use;
- roll call training videos;
- Arrive Alive stickers placed in all Agency vehicles;
- weekly public safety radio messages;
- one hour class during annual in-service training;
- line of duty death notifications emailed to all sworn and corrections officers; and
- whiteboard displays with number of days since last department collision posted at each station.

### 6-700 WORK SITE SAFETY INSPECTIONS

In order for the Sheriff's Office Risk Management and Safety Program to be effective, it must provide for the regular inspection of all work sites.

Authorization for the Safety Officer to conduct internal Sheriff's Office safety inspections is granted by the Sheriff.

Inspections are important as they serve to:

- Identify safety and health hazards before accidents occur;
- Stimulate interest, and encourage active participation in the Risk Management and Safety Program through personal contact between the inspector and individuals on the job. Employees are frequently able to point out unsafe conditions that might otherwise go uncorrected; and



Administrative and Operational Manual

September 12, 2022

- Determine necessary changes in the program, e.g., revisions to procedures, changes in the training program, and improvement in supervisory practices.

### 6-701 TYPES OF INSPECTIONS

The following inspections are carried out under the Sheriff's Office Risk Management and Safety Policy:

**Safety Audit:** Regular inspections that are to be conducted by the Safety Officer at all work sites. Their purpose is to determine whether the Sheriff's Office is providing a safe and healthful place of employment in compliance with the MOSHA Law, and the Risk Management and Safety Policy, and whether employees are performing their duties in a safe manner.

**General Inspections:** It is the responsibility of division commanders to perform regular inspections and document unresolved safety hazards and develop a plan of corrective action.

**Special Inspections:** Special inspections are limited in scope and conducted for a special purpose, or in special areas. Examples of situations requiring special inspections are:

- Changes in working conditions, e.g., occupancy of new buildings, use of new or different equipment, and assignment of new activities;
- In response to a report of a safety or health hazard;
- As a part of special campaign such as Fire Prevention Week;
- In the course of an accident investigation;
- As a follow-up to a previous inspection.

Special inspections may be conducted by the Safety Officer, supervisors, and representatives of management.

In the event of a safety hazard, an employee shall immediately notify both the individual in charge and any employees whom they consider to be in imminent danger, and shall request that they be removed from the area. The Safety Officer, if necessary, shall have the authority either to remove employees or suspend operations.

All employees shall assist in eliminating the danger, although the ultimate responsibility for this lies with division commanders.

The employee shall remain at the establishment or area until the danger has been eliminated, either by removal of the hazard or suspension of operations.

When the Safety Officer discovers a violation of imminent danger, and the supervisor refuses to comply with the recommendations of the Safety Officer, the Safety Officer shall inform the division commander of the alleged violation. The following action shall be taken:

- Review the alleged violation, and, if they concur, again request to suspend operations until the hazard has been eliminated;
- If the commander refuses to take corrective action, the Safety Officer will report the alleged violation to the appropriate Assistant Sheriff.

### 6-702 SAFETY INSPECTION GUIDELINES



## Administrative and Operational Manual

September 12, 2022

Safety inspections shall be performed on a schedule that will be convenient to the division commander concerned. Individuals within the division shall fully cooperate with the inspection to ensure that all areas are covered and all hazards are itemized.

Those conducting a safety inspection shall utilize check lists appropriate for each area being inspected, and emphasis shall be placed on standards established by the division.

Emphasis will be placed upon the condition of the facility. Equipment and machines as well as implementation of the overall safety program such as:

- Good housekeeping;
- Use of prescribed protective equipment;
- Compliance with safety rules and regulations;
- Qualification of drivers and condition of vehicles;
- Condition of ladders;
- Proper storage of flammable / combustible liquids;
- Portable firefighting equipment, first aid kits and emergency lighting;
- Condition of power and hand tools;
- Proper guarding of powered equipment and machines;
- Excessive noise levels.

Supervisors shall inform all employees of any unsafe conditions that cannot be immediately corrected and ensure that all necessary precautions are taken to prevent accidents.

Deficiencies shall be posted for review by all employees and corrected as quickly as possible. Corrections requiring special monetary funds or those beyond control of the division should be presented to the commander for resolutions.

**NOTE:** The Safety Officer is charged with the responsibility to note any deficiencies that exist, document those deficiencies, and recommend the necessary corrective action. Should a situation arise whereby the division commander determines that the corrective action is not warranted, not cost effective, or funding is not available, the final determination will be made by the appropriate Assistant Sheriff.

## 6-703 INSPECTION RECORDS

Upon completion of an inspection, a brief memorandum reporting the inspection and any pertinent information, shall be forwarded to the Agency Safety Officer.

All inspection reports shall show the following:

- Date of inspection;
- Inspector's name(s);
- List of deficiencies discovered; and
- Recommendations for correction of deficiencies.

A copy of the report will be maintained by the affected division commander for a period of three (3) years.

## 6-704 NOTICE OF SAFETY VIOLATIONS

The Safety Officer, making inspections under the Risk Management and Safety Program, reports inspections with a brief memo to the division commander. Violations are reported by means of the Notice of Safety Violation Form #939. Notices shall be used to educate and evaluate Sheriff's Office personnel.



## Administrative and Operational Manual

September 12, 2022

## 6-705 JOB SAFETY ANALYSIS FOR HAZARDOUS WORK

To eliminate accidents in high hazard areas, it is mandatory that each supervisor thoroughly check his workers on the hazards that exist and ensure that they understand the methods of doing each job safely when such hazards cannot be eliminated.

Relying on memory alone during the instruction of an employee is assurance that some important items will be overlooked. It is therefore essential that the supervisor use published work rules which define the correct work procedures. This enables him to attain a consistent quality of instruction that instills employee confidence in his own capabilities and those of management. By providing employees with a copy of the work rules after instruction, he has a ready reference for review. Procedures for job safety training are as follows:

- The job is broken down into basic steps. These steps describe what is to be done in sequence;
- Each step is analyzed for possible hazards that could cause an accident. The purpose is to identify as many hazards as possible whether created by the environment or connected with the mechanics of the job;
- When the hazards and potential accidents associated with each step are identified and their causes understood, ways of eliminating them shall be developed. There are four ways in which this can be handled:
  - Eliminate the process or operation, or provide a substitute which can be done without the hazard; or
  - Isolate the process or operation so as to eliminate or minimize the hazard; or
  - Provide guards or automatic devices to eliminate or minimize the hazard; or
  - Provide personal protective equipment and enforce its use to eliminate the possibility of injury.

By using the information gathered, division work rules shall be written, made available to employees and maintained on file for periodic review. This becomes a document to assist the supervisor in instructing his employees in safe methods of performing their jobs and what protective equipment will be required.

## 6-706 JOB SAFETY TRAINING

Supervisors must not assume that a newly hired, newly assigned or reassigned employee thoroughly knows all the safe job procedures. The employee must be trained. The four-point method of job instruction has been found to work best: Preparation, presentation, performance, and follow-up.

### Preparation:

- Put the employee at ease;
- Define the job and find out what the employee already knows about it;
- Get the employee interested in learning the job;
- Place the employee in the correct position to do the job.

### Presentation:

- Tell, show and demonstrate one important step at a time;
- Stress each key point;
- Instruct clearly, completely and patiently, but cover no more than the employee can master each time.

### Performance:

- Have the employee do the job, coach him while he works;



**Administrative and Operational Manual**

**September 12, 2022**

- Have the employee explain each key point while performing the job;
- Make sure the employee understands all safe job / work procedures;
- Continue until you know the employee knows.

**Follow-up:**

- Put the employee on his own;
- Designate to whom the employee goes for help;
- It is the responsibility of the supervisor to frequently check the employee's safe work procedures and to continuously encourage safe work practices.

To document job safety training program participation, an Employee Training Record must be completed for all Sheriff's Office employees participating in training programs. This written documentation will reflect the employee's signature and date, and shall detail the training topic(s), presenter / instructor, and any audio / visual aids used. This documentation must be forwarded to Human Resources within 30 days for filing.

**SO/14-2 RULES AND REGULATIONS, ORDERS, ETC.**

You are hereby notified that all Agency rules and regulations, orders, instructions, directives, memoranda, etc., issued by Rex W. Coffey shall remain valid until otherwise rescinded.

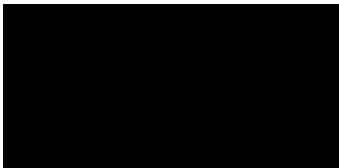

Troy D. Berry, Sheriff  
Charles County, Maryland



[REDACTED]





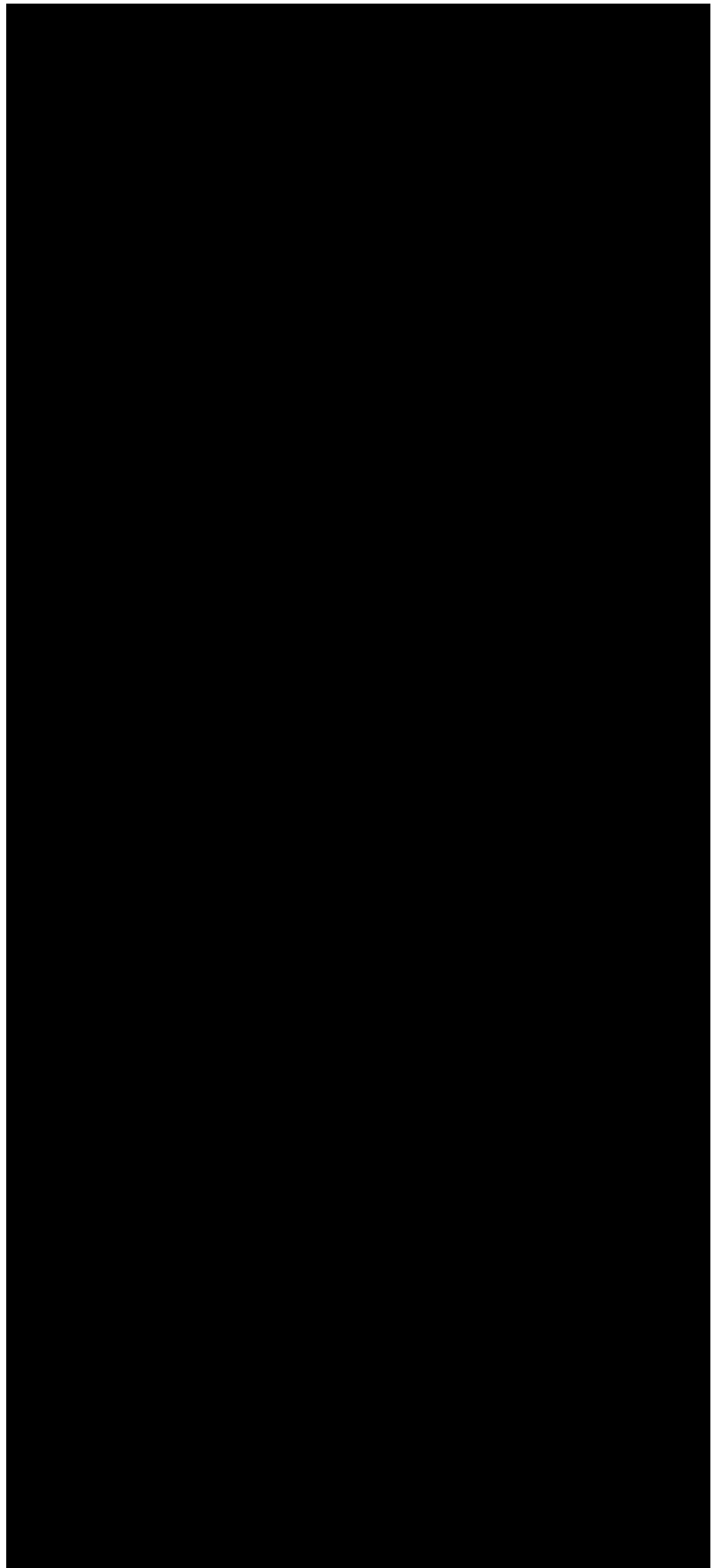

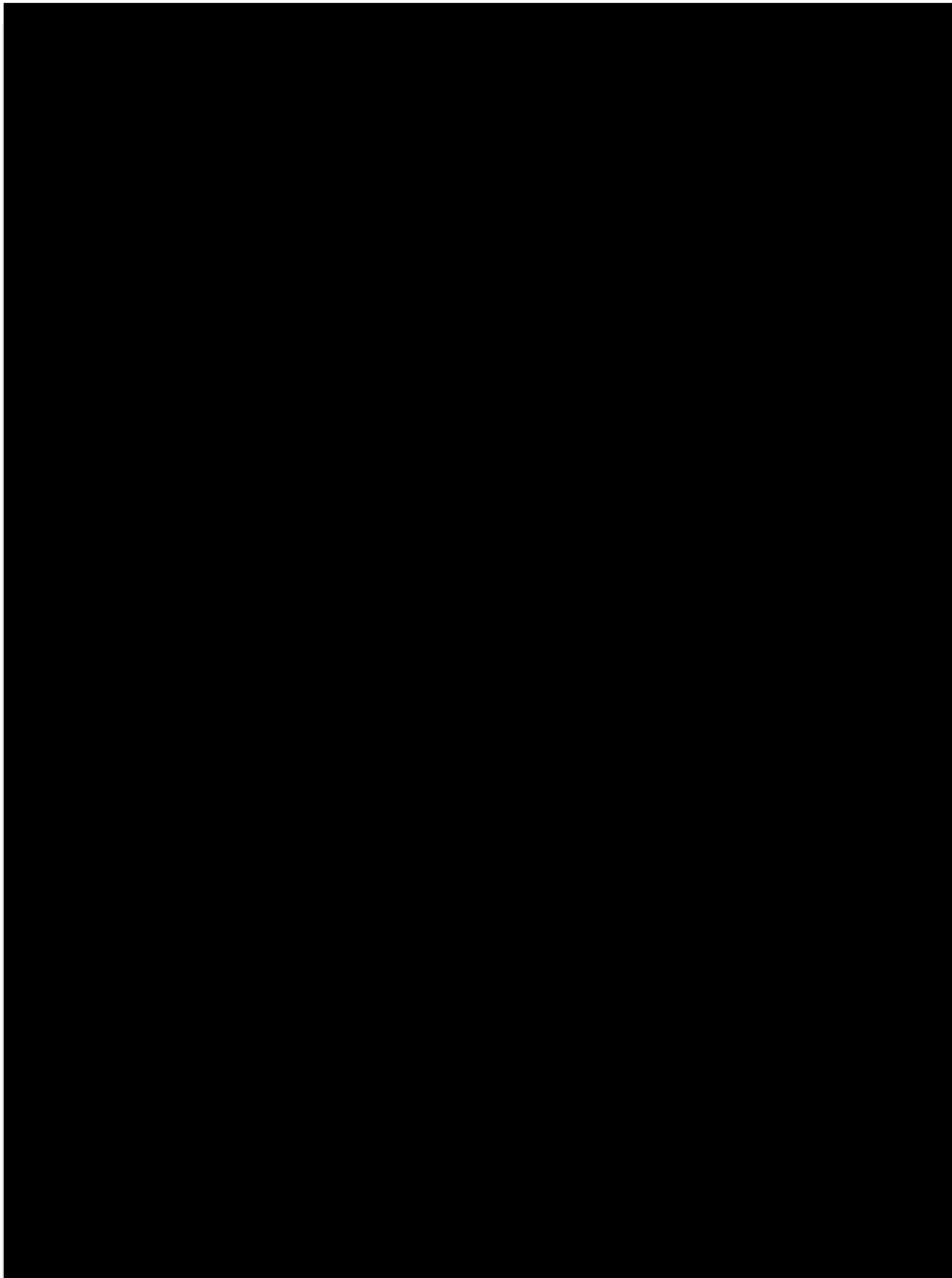

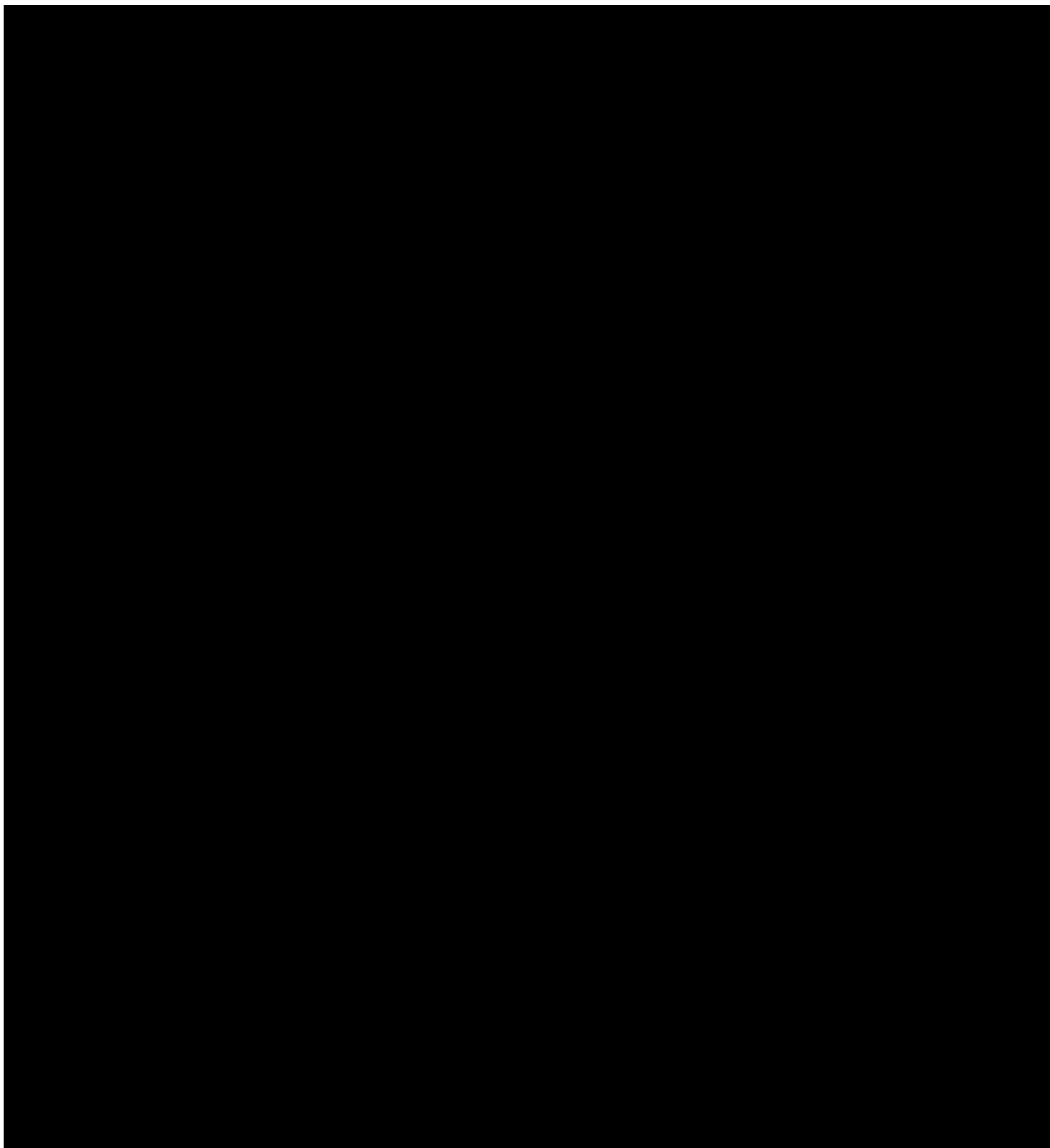

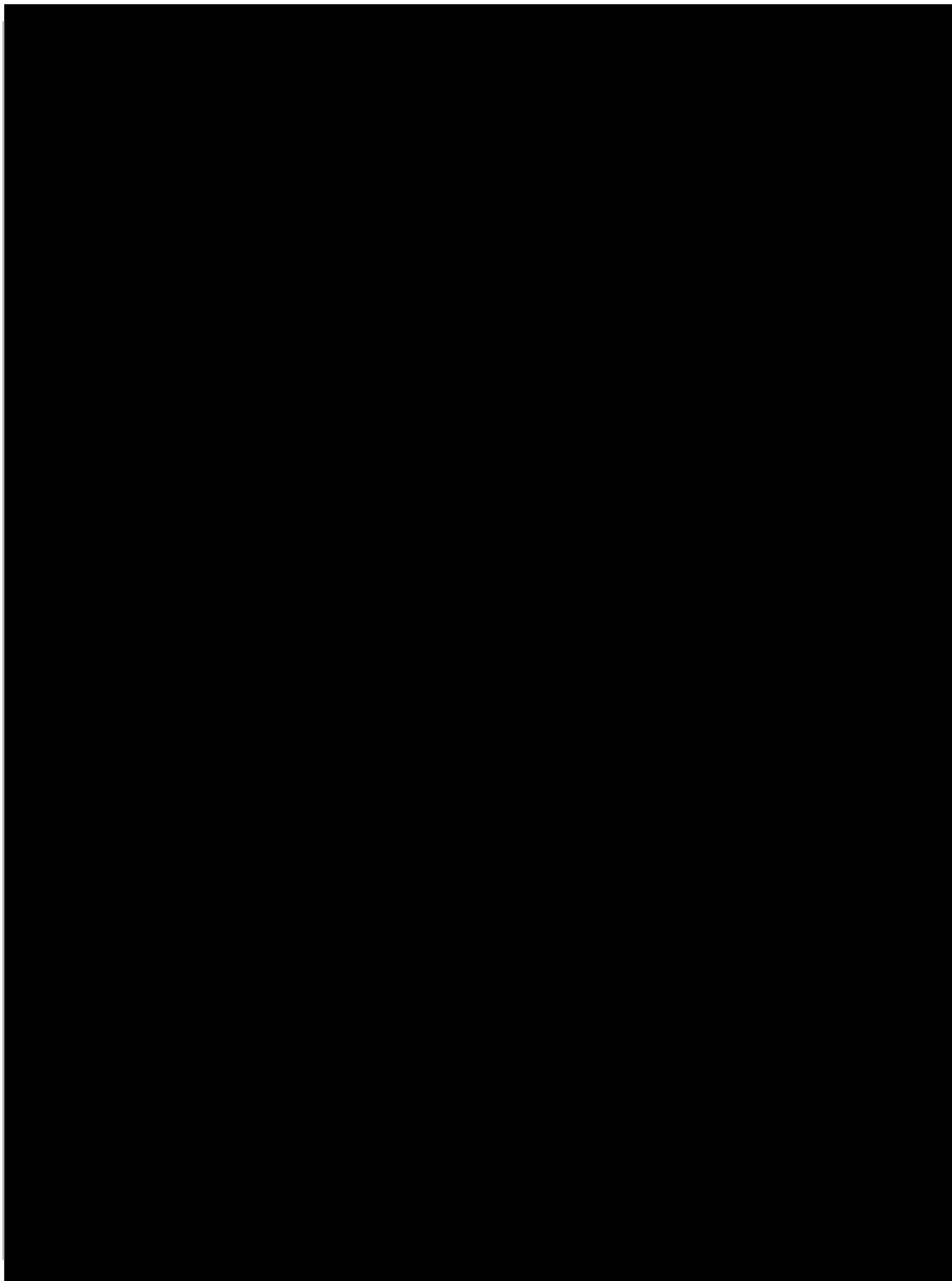

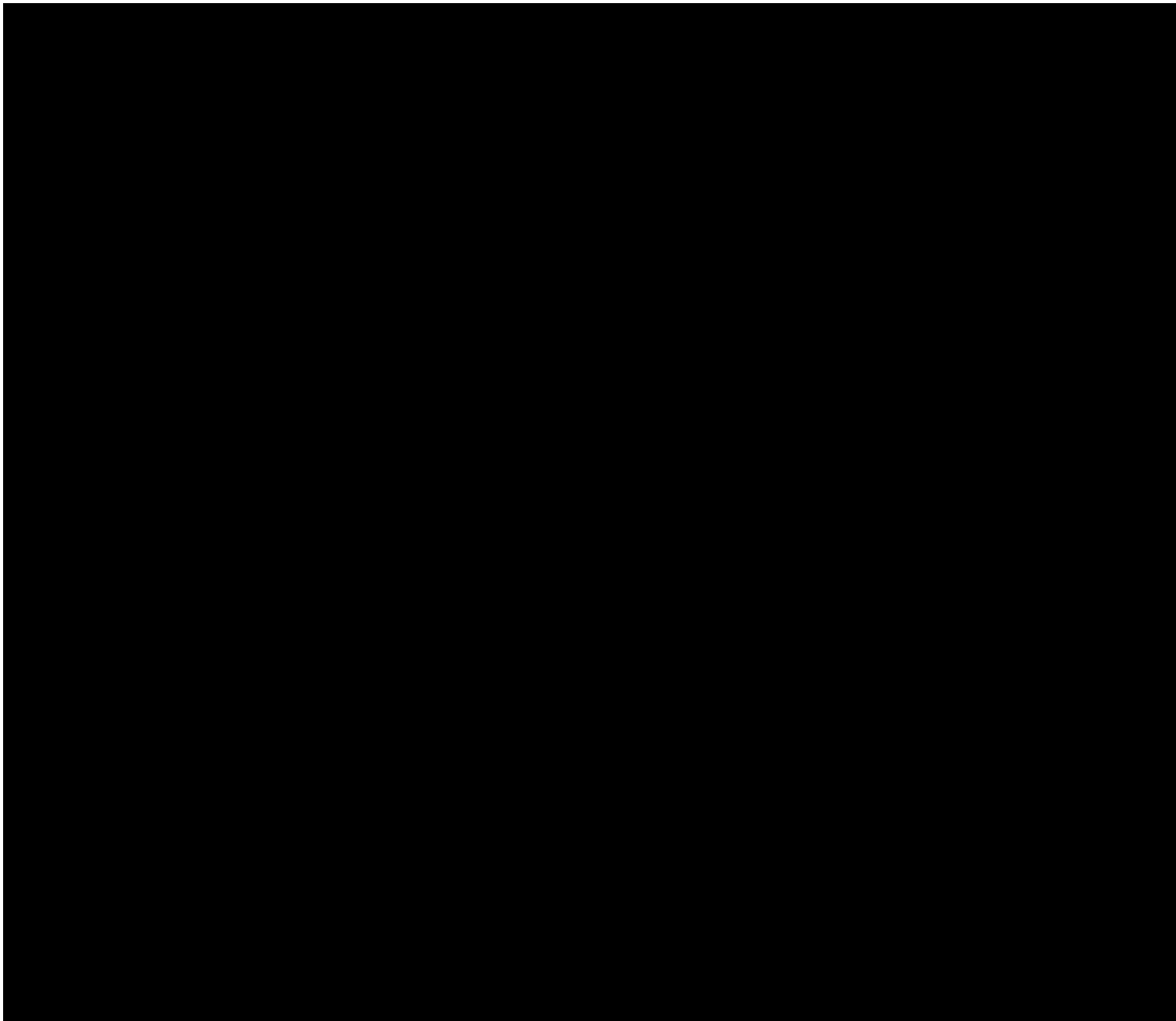





Administrative and Operational Manual

September 12, 2022

[REDACTED]

[REDACTED]

[REDACTED]

- [REDACTED]
- [REDACTED]

[REDACTED]

- [REDACTED]
- [REDACTED]

[REDACTED]

- [REDACTED]
- [REDACTED]
- [REDACTED]
- [REDACTED]

[REDACTED]

[REDACTED]

- [REDACTED]
- [REDACTED]
- [REDACTED]
- [REDACTED]
- [REDACTED]

[REDACTED]

[REDACTED]

[REDACTED]

[REDACTED]



## Administrative and Operational Manual

September 12, 2022

## SO/21-02 UPDATE - SWORN/CORRECTIONAL OFFICER BONUS PROGRAMS (Updated 7/8/2022)

### Purpose:

The purpose of the programs outlined in this special order are intended to aid the Agency's recruitment efforts by attracting qualified sworn and correctional officer applicants to the Agency. The programs offer financial incentives to current employees through referral bonuses, as well as new employees through sign-on bonuses (for all new sworn / correctional officers) and relocation bonuses (for new correctional officers). The details and requirements for each of the programs are listed below:

### Scope:

This program will continue until the number of sworn and correctional officer vacancies reaches an acceptable level or as the budget permits.

### Sworn Police Officer Programs

#### Sign-on Bonus Program:

- Police Officer Sign-on Bonus: \$2,100 (Paid in 3 installments)
  - \$700 when hired;
  - \$700 upon academy graduation;
  - \$700 upon completion of probation.

#### Lateral/Comparative Compliance Police Officer:

- Lateral/ Comparative Compliance Police Officer Sign-On Bonus: \$2,100 (Paid in 3 installments)
  - \$700 when hired;
  - \$700 upon completion of the FTO program and released as a solo officer;
  - \$700 upon completion of probation.

### Correctional Officer Programs

#### Sign-on Bonus Program:

- Correctional Officer Sign-on Bonus: \$10,000 (Paid in 3 installments)
  - \$3,333 when hired;
  - \$3,333 upon academy graduation;
  - \$3,334 upon completion of probation.

#### Lateral/Comparative Compliance Officer:

- Lateral/Comparative Compliance Correctional Officer Sign-On Bonus: \$10,000 (Paid in 3 installments)
  - \$3,333 when hired;
  - \$3,333 upon completion of the FTO program and released as a solo officer;
  - \$3,334 upon completion of probation.

#### Relocation Bonus:

- Re-location bonus for newly hired Correctional Officers moving from a residence located at least 50 miles from the Charles County line.
  - Re-location bonus of \$5,000 if the employee re-locates to Charles County or within a 25-mile radius of the Charles County line;





**Administrative and Operational Manual**

**September 12, 2022**

- Employee will receive the bonus upon showing proof of address change;
- Re-location bonus benefit expires one year from the date of employment.

**Employee Referral Bonus**

- Employee Referral Bonus for a Sworn Officer or Correctional Officer: \$1,000 (2 installments)
  - \$500 when hired;
  - \$500 after the referred employee graduates the academy; or
  - \$500 upon completion of probation for a lateral officer.

**Terms & Conditions:**

- Only one employee will be eligible for the referral bonus per newly hired employee;
- The applicant will provide the Agency with the name of the employee who has referred them. This will be accomplished during the new employee orientation and will be documented via Sign-on Bonus / Employee Referral application;
- Employees not eligible for the referral bonus are as follows;
  - Employees of the Pre-employment and Recruiting Section;

Employees acting in the capacity of a recruiter or attending recruiting events on behalf of the agency at the time an applicant is recruited.



## Administrative and Operational Manual

September 12, 2022

## SO/21-3 D.S.S. NOTIFICATIONS

Recently, the Department of Social Services approached the C.C.S.O. and the Town of LaPlata Police Department in reference to officers responding to their facility with citizens in need of assistance. In some cases, citizens were dropped off at D.S.S. outside of operating hours, causing a few issues for D.S.S. staff.

Agency representatives met with D.S.S. administrative staff on 09/17/2021. As a result of the meeting, the following, short-term guidance was developed to assist officers who interact with persons in need of D.S.S. assistance.

### **During daytime/business hours, officers shall:**

- Call (301) 392-6724.
- Follow the answering machine prompts until you reach a live person.
- Calls will be triaged based on the initial contact to determine if the specific situation falls within the D.S.S. service mandates.
- Do not drop the individual off at D.S.S. without first making contact with a D.S.S. representative.

### **After hours (1600 – 0800, weekends and Holidays), officers shall:**

- Call the number for the on-call D.S.S. representative provided by Communications.
- If unable to reach the scheduled on-call representative, call the next individual on the phone list until a representative is reached, up to and including the Director.
- If you are still unable to reach a representative, notify your Division Commander through the chain of command.
- Do not drop the individual off at D.S.S. without first making contact with a D.S.S. representative.

Due to D.S.S. staffing levels, a representative may not be able to respond immediately, even if they have determined they are able to provide assistance. D.S.S. asks that the intake worker speak directly to the person in need so they can plan the best response and give the individual an estimated response time. In some instances, the D.S.S. representative may determine they are unable to assist or provide services to the individual in question.

It is recognized officers may be unable to stay with the individual for an extended period of time. In those situations, the following steps should be taken:

- If the D.S.S. intake worker determines they are able to assist the individual, but expect an extended response time, officers shall indicate the details in the notes of the call sheet, notify their immediate supervisor and clear the call for service.
- If the D.S.S. intake worker determines they are unable to provide assistance, and there are no other alternatives available (e.g. Lifestyles, Angels Watch), officers shall indicate that fact in the notes of the call sheet, notify their immediate supervisor and clear the call for service.

The Agency and the Department of Social Services are beginning a review of the M.O.U. between the C.C.S.O. and D.S.S. to identify appropriate long-term procedures to address this issue. Agency personnel will be notified of any changes to this directive as needed.



## Administrative and Operational Manual

September 12, 2022

This Special Order is specific to D.S.S. notifications for persons in need of assistance not currently addressed in the Administrative and Operational Manual. Notifications related to physical and sexual child abuse (AOM 3-163) or vulnerable adult investigations (AOM 3-165) remain unchanged.

## SO/22-1 JUVENILE JUSTICE REFORM ACT

During the 2022 session, the General Assembly enacted the Juvenile Justice Reform Act that goes into effect on June 1, 2022.

Effective June 1st:

- 1) No child may be placed in detention if the most serious offense committed by the child is a misdemeanor unless a handgun was involved.
- 2) Children under age 13 will no longer be charged on a Juvenile Offense Report, with the exception of those outlined in paragraph 3.
  - a. If the child has engaged in behavior that would have caused an officer to file a JOR prior to June 1, 2022, the officer will document the incident in a report and forward the report to the Teen Court Coordinator.
- 3) A child who is at least 10 years old who has committed a "crime of violence" may still be charged on a JOR. "Crime of violence" is defined in Criminal Law §14-101. Second degree assault is not a crime of violence. See the list below.
- 4) The Juvenile Justice Reform Act does not affect charging a juvenile as an adult.

Effective Immediately:

If a child has engaged in behavior that *would have* caused an officer to file a JOR prior to June 1, 2022, the process will be as follows:

- The officer will document the incident in an Offense/Incident Report and forward the report to the Records Section;
- The officer will complete the Charles County Sheriff's Office Child in Need of Supervision (CINS) Intake Report (CCSO Form #157) and forward to the Records Section. Note: If the child were involved in a second-degree assault, block #3, "*Deposits himself as to injure or endanger himself or others*" would apply;
- The Records Section will forward a copy of the CINS Intake Report to the Teen Court Coordinator;
- The Teen Court Coordinator will forward a copy of all CINS forms to the Department of Juvenile Services (DJS).

### Crimes of Violence (Crim. Law §14-101)

- (1) abduction;
- (2) arson in the first degree;
- (3) kidnapping;
- (4) manslaughter, except involuntary manslaughter;
- (5) mayhem;



Administrative and Operational Manual

September 12, 2022

(6) maiming, as previously proscribed under former Article 27, §§ 385 and 386 of the Code; OFFICE OF THE SHERIFF, CHARLES COUNTY, MD Administrative and Operational Manual Effective 6/1/2022

(7) murder;

(8) rape;

(9) robbery under § 3-402 or § 3-403 of this article;

(10) carjacking;

(11) armed carjacking;

(12) sexual offense in the first degree;

(13) sexual offense in the second degree;

(14) use of a firearm in the commission of a felony except possession with intent to distribute a controlled dangerous substance under § 5-602(2) of this article, or other crime of violence;

(15) child abuse in the first degree under § 3-601 of this article;

(16) sexual abuse of a minor under § 3-602 of this article if:

(i) the victim is under the age of 13 years and the offender is an adult at the time of the offense; and

(ii) the offense involved:

1. vaginal intercourse, as defined in § 3-301 of this article;

2. a sexual act, as defined in § 3-301 of this article;

3. an act in which a part of the offender's body penetrates, however slightly, into the victim's genital opening or anus; or

4. the intentional touching of the victim's or the offender's genital, anal, or other intimate area for sexual arousal, gratification, or abuse;

(17) home invasion under § 6-202(b) of this article;

(18) a felony offense under Title 3, Subtitle 11 of this article;

(19) an attempt to commit any of the crimes described in items (1) through (18) of this subsection;

(20) continuing course of conduct with a child under § 3-315 of this article;

(21) assault in the first degree;

(22) assault with intent to murder;

(23) assault with intent to rape;

(24) assault with intent to rob;

(25) assault with intent to commit a sexual offense in the first degree; and

(26) assault with intent to commit a sexual offense in the second degree.